

Technical data sheet Light curtain receiver

Part no.: 50131842

CML720i-R05-1040.A/PN-M12



Figure can vary

Contents

- Technical data
- Dimensioned drawings
- Electrical connection
- Operation and display
- Suitable transmitters
- Part number code
- Notes
- Accessories



Technical data

Basic data

Series	720
Operating principle	Throughbeam principle
Device type	Receiver
Contains	2x BT-NC sliding block
Application	Object measurement

Special version

Special version	Crossed-beam scanning
	Diagonal-beam scanning
	Parallel-beam scanning

Optical data

Operating range	Guaranteed operating range
Operating range	0.1 ... 3.5 m
Operating range limit	Typical operating range
Operating range limit	0.1 ... 4.5 m
Measurement field length	1,040 mm
Number of beams	208 Piece(s)
Beam spacing	5 mm

Measurement data

Minimum object diameter	10 mm
-------------------------	-------

Electrical data

Protective circuit	Polarity reversal protection
	Short circuit protected
	Transient protection

Performance data

Supply voltage U_B	18 ... 30 V, DC
Residual ripple	0 ... 15 %, From U_B
Open-circuit current	0 ... 270 mA, The specified values refer to the entire package consisting of transmitter and receiver.

Inputs/outputs selectable

Output current, max.	100 mA
Input resistance	6,000 Ω
Number of inputs/outputs selectable	2 Piece(s)
Type	Inputs/outputs selectable
Voltage type, outputs	DC
Switching voltage, outputs	Typ. U_B / 0 V
Voltage type, inputs	DC
Switching voltage, inputs	high: $\geq 6V$
	low: $\leq 4V$

Input/output 1

Activation/disable delay	1 ms
--------------------------	------

Timing

Readiness delay	1,500 ms
Cycle time	6.64 ms
Response time per beam	30 μs

Interface

Type	PROFINET
------	----------

Profinet

Function	Process
Conformance class	B
Protocol	PROFINET RT
Switch functionality	Integrated
Transmission speed	10 Mbit/s
	100 Mbit/s

Service interface

Type	IO-Link
------	---------

IO-Link

Function	Configuration via software
	Service

Connection

Number of connections	3 Piece(s)
Plug outlet	Axial

Connection 1

Function	Configuration interface
	Connection to transmitter
	Signal IN
	Signal OUT
	Voltage supply

Type of connection	RJ45
Thread size	M12
Type	Male
Material	Metal
No. of pins	8 -pin
Encoding	A-coded

Connection 2

Function	BUS IN
Type of connection	Connector
Thread size	M12
Type	Female
Material	Metal
No. of pins	4 -pin
Encoding	D-coded

Connection 3

Function	BUS OUT
Type of connection	Connector
Thread size	M12
Type	Female
Material	Metal
No. of pins	4 -pin
Encoding	D-coded

Mechanical data

Design	Cubic
Dimension (W x H x L)	29 mm x 35.4 mm x 1,115 mm
Housing material	Metal
Metal housing	Aluminum
Lens cover material	Plastic
Net weight	1,250 g
Housing color	Silver
Type of fastening	Groove mounting
	Via optional mounting device

Technical data

Operation and display

Type of display	LED
	OLED display
Number of LEDs	4 Piece(s)
Type of configuration	Software
	Teach-in
Operational controls	Membrane keyboard

Environmental data

Ambient temperature, operation	-30 ... 60 °C
Ambient temperature, storage	-40 ... 70 °C

Certifications

Degree of protection	IP 65
Protection class	III
Certifications	c CSA US
Standards applied	IEC 60947-5-2

Classification

Customs tariff number	90314990
eCl@ss 5.1.4	27270910
eCl@ss 8.0	27270910
eCl@ss 9.0	27270910
eCl@ss 10.0	27270910
eCl@ss 11.0	27270910
ETIM 5.0	EC002549
ETIM 6.0	EC002549
ETIM 7.0	EC002549

Dimensioned drawings

All dimensions in millimeters

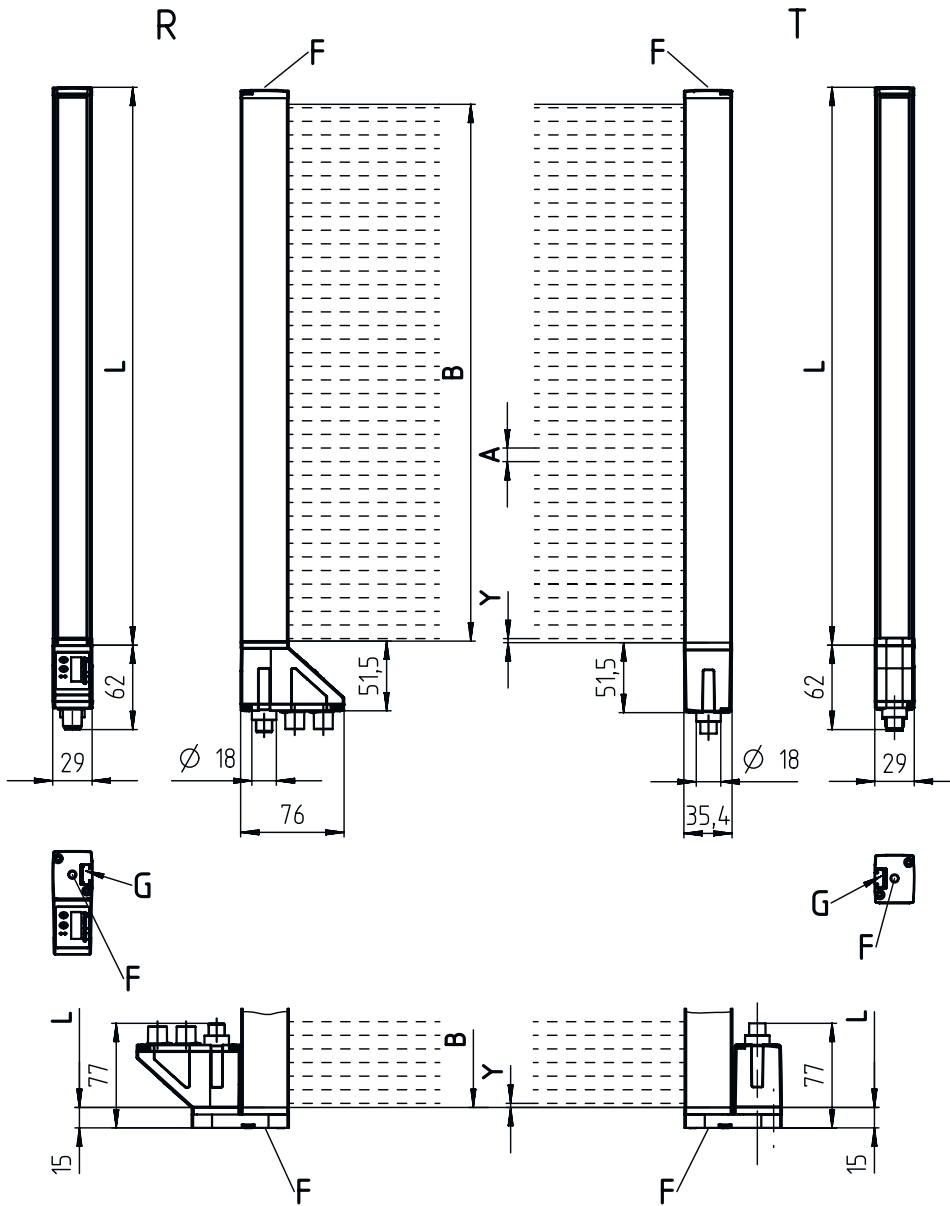

- | | | | |
|---|----------------------------------|---|------------------------|
| A | Beam spacing 5 mm | L | Profile length 1048 mm |
| B | Measurement field length 1040 mm | T | Transmitter |
| F | M6 thread | R | Receiver |
| G | Fastening groove | Y | 2.5 mm |

Dimensioned drawings



- A PWR / SW IN / OUT
- B BUS IN
- C BUS OUT

Electrical connection

Connection 1

X1

Function	Configuration interface Connection to transmitter Signal IN Signal OUT Voltage supply
Type of connection	RJ45
Thread size	M12
Type	Male
Material	Metal
No. of pins	8 -pin
Encoding	A-coded

Pin	Pin assignment
1	V+
2	I/O 1
3	GND
4	IO-Link
5	I/O 2
6	RS 485 Tx+
7	RS 485 Tx+
8	FE/SHIELD



Connection 2

X2A

Function	BUS IN
Type of connection	Connector
Thread size	M12
Type	Female
Material	Metal
No. of pins	4 -pin
Encoding	D-coded

Pin	Pin assignment
1	TD0+
2	RD0+
3	TD0-
4	RD0-



Electrical connection

Connection 3

X2B

Function	BUS OUT
Type of connection	Connector
Thread size	M12
Type	Female
Material	Metal
No. of pins	4 -pin
Encoding	D-coded

Pin Pin assignment

1	TD0+
2	RD0+
3	TD0-
4	RD0-



Operation and display

LED	Display	Meaning
1	Green, continuous light	Operational readiness
	Green, flashing	Teach / error
2	Yellow, continuous light	Light path free, with function reserve
	Yellow, flashing	No function reserve
	Off	Object detected
3	Green, continuous light (at the X2A / X2B connector)	Link
4	Yellow, continuous light (at the X2A / X2B connector)	Activity

Suitable transmitters

	Part no.	Designation	Article	Description
	50119380	CML720i-T05-1040.A-M12	Light curtain transmitter	Operating range: 0.1 ... 3.5 m Connection: Connector, M12, Axial, 5 -pin

Part number code

Part designation: CML7XXi-YYZ-AAAA.BCCDDDD-EEEEFF

CML	Operating principle Measuring light curtain
7XXi	Series 720i: 720i series 730i: 730i series
Y	Device type T: transmitter R: receiver
ZZ	Beam spacing 05: 5 mm 10: 10 mm 20: 20 mm 40: 40 mm
AAAA	Measurement field length [mm], dependent on beam spacing
B	Equipment A: connector outlet, axial R: rear connector outlet

Part number code

CCC	Interface L: IO-Link /CN: CANopen /PB: PROFIBUS /PN: PROFINET /CV: Analog current and voltage output /D3: RS 485 Modbus
DDD	Special equipment -PS: Power Setting
EEE	Electrical connection M12: M12 connector
FFF	-EX: Explosion protection

Note



A list with all available device types can be found on the Leuze website at www.leuze.com.

Notes

 **Observe intended use!**



- This product is not a safety sensor and is not intended as personnel protection.
- The product may only be put into operation by competent persons.
- Only use the product in accordance with its intended use.



For UL applications:



- For UL applications, use is only permitted in Class 2 circuits in accordance with the NEC (National Electric Code).
- These proximity switches shall be used with UL Listed Cable assemblies rated 30V, 0.5A min, in the field installation, or equivalent (categories: CYJV/ CYJV7 or PVVA/PVVA7)

Accessories

Connection technology - Connection cables

	Part no.	Designation	Article	Description
	50132079	KD U-M12-5A-V1-050	Connection cable	Connection 1: Connector, M12, Axial, Female, A-coded, 5 -pin Connection 2: Open end Shielded: No Cable length: 5,000 mm Sheathing material: PVC
	50135074	KS ET-M12-4A-P7-050	Connection cable	Suitable for interface: Ethernet Connection 1: Connector, M12, Axial, Male, D-coded, 4 -pin Connection 2: Open end Shielded: Yes Cable length: 5,000 mm Sheathing material: PUR

Accessories

Connection technology - Interconnection cables

	Part no.	Designation	Article	Description
	50135081	KSS ET-M12-4A-RJ45-A-P7-050	Interconnection cable	Suitable for interface: Ethernet Connection 1: Connector, M12, Axial, Male, D-coded, 4 -pin Connection 2: RJ45 Shielded: Yes Cable length: 5,000 mm Sheathing material: PUR

Connection technology - Y distribution cables

	Part no.	Designation	Article	Description
	50118183	K-Y1 M12A-5m-M12A-S-PUR	Interconnection cable	Connection 1: Connector, M12, Axial, Female, A-coded, 5 -pin Connection 2: Connector, M12, Axial, Male, A-coded, 5 -pin Connection 3: Connector, M12, Axial, Female, A-coded, 8 -pin Shielded: Yes Cable length fork 1: 5,000 mm Cable length fork 2: 150 mm Sheathing material: PUR

Mounting technology - Mounting brackets

	Part no.	Designation	Article	Description
	50142900	BT 700M.5-2SET	Mounting device set	Design of mounting device: Bracket mounting Fastening, at system: Through-hole mounting, T slotted hole Mounting bracket, at device: Screw type, Sliding block Type of mounting device: Rigid Material: Steel

Mounting technology - Swivel mounts

	Part no.	Designation	Article	Description
	429046	BT-2R1	Mounting bracket set	Fastening, at system: Through-hole mounting Mounting bracket, at device: Clampable Type of mounting device: Turning, 360° Material: Metal, Plastic

Configuration devices

	Part no.	Designation	Article	Description
	50121098	SET MD12-US2-IL1.1 + Zub.	Diagnostics set	Interface: USB Connections: 2 Piece(s) Degree of protection: IP 20

Accessories

Services

	Part no.	Designation	Article	Description
	S981001	CS10-S-110	Start-up support	<p>Details: Performed at location of customer's choosing, duration: max. 10 hours.</p> <p>Conditions: Devices and connection cables are already mounted, price not including travel costs and, if applicable, accommodation expenses.</p> <p>Restrictions: No mechanical (mounting) and electrical (wiring) work performed, no changes (attachments, wiring, programming) to third-party components in the nearby environment.</p>
	S981005	CS10-T-110	Product training	<p>Details: Location and content to be agreed upon, duration: max. 10 hours.</p> <p>Conditions: Price not including travel costs and, if applicable, accommodation expenses.</p> <p>Restrictions: Travel costs and accommodation expenses charged separately and according to expenditure.</p>

Note



A list with all available accessories can be found on the Leuze website in the Download tab of the article detailed page.