

the sensor people

ODS... 9 / OD... 96B Optical Distance Sensors



en 06-2014/12 50107320-05
We reserve the right to
make technical changes

© 2014

Leuze electronic GmbH + Co. KG

In der Braike 1

D-73277 Owen / Germany

Phone: +49 7021 573-0

Fax: +49 7021 573-199

<http://www.leuze.com>

info@leuze.de

1	General information	6
1.1	Explanation of symbols	6
1.2	Important terms	6
1.3	Declaration of conformity	8
2	Safety	9
2.1	Proper use	9
2.2	Foreseeable misuse	10
2.3	Competent persons	10
2.4	Disclaimer	11
2.5	Laser safety notices – Laser class 1	11
2.6	Laser safety notices – Laser class 2	12
3	The different sensor types	16
3.1	ODSL 9 with triangulation measurement	16
3.2	ODS... 96B with triangulation measurement	17
3.3	ODSL/ODKL/ODSIL 96B with time-of-flight measurement	17
4	Description ODSL 9	18
4.1	General description	18
4.2	Typical areas of application for the ODSL 9	19
4.3	ODSL 9 variants	21
4.3.1	Type code	21
4.4	ODSL 9/C or /V with analog output	22
4.5	ODSL 9/L with IO-Link interface	24
4.5.1	IO-Link process and service data	24
4.5.2	IO-Link system commands and diagnostics (observation)	25
4.6	ODSL 9/D with serial interface	26
4.6.1	Measurement value output for various transmission types	26
4.6.2	Commands for remote control operation	28
4.6.3	Termination of the data lines of the ODSL 9/D3	30
4.6.4	Operation on the fieldbus and the Ethernet	31
4.7	ODSL 9/66 with two switching outputs	32
5	Description ODS... 96B/ODK... 96B	33
5.1	General description	33
5.2	Typical areas of application for the ODS... 96B/ODK... 96B	35
5.3	ODS... 96B/ODK... 96B variants	41
5.3.1	Part number code	42
5.4	ODS... 96B/ODK... 96B M/C and M/V with analog output	43
5.5	ODS... 96B/ODK... 96B M/L with IO-Link interface	47
5.5.1	IO-Link process and service data	47
5.5.2	IO-Link system commands and diagnostics (observation)	48
5.6	ODS... 96B/ODK... 96B M/D with serial interface	49
5.6.1	Measurement value output for various transmission types	49

5.6.2	Commands for remote control operation.....	50
5.6.3	Termination of the data lines of the OD... 96B/D3.....	53
5.6.4	Operation on the fieldbus and the Ethernet	54
5.7	ODS... 96B/ODK...96B M/66 with two switching outputs.....	55
6	Installation	56
6.1	Storage and transport	56
6.2	Mounting	56
7	Operation	59
7.1	Indicator and operating elements.....	59
7.1.1	LED status displays.....	60
7.1.2	Control buttons	60
7.1.3	Displays.....	61
7.1.4	Operation/navigation	62
7.1.5	Reset to factory settings.....	63
7.2	Configuration / menu structure.....	64
7.2.1	Input	64
7.2.2	Output Q1	65
7.2.3	Output Q2.....	66
7.2.4	Analog Output	67
7.2.5	Serial	68
7.2.6	Application.....	69
7.2.7	Settings	72
7.3	Configuration example - lower switching point.....	74
7.4	Teach-in	75
7.4.1	Setting the teach point	75
7.4.2	Teach-in for triangulation sensors	76
7.4.3	Teach-in for time-of-flight sensors	78
7.5	Trigger.....	79
7.6	Measurement modes	79
7.7	Measure filter	80
7.8	Distance calibration.....	81
7.8.1	Preset or Offset	81
7.8.2	Referencing for triangulation sensors	83
7.8.3	Teach-in of Offset and Preset via the binary input	83
8	Configuration software.....	85
8.1	Connecting to a PC.....	85
8.2	Installing the configuration software.....	86
8.3	Starting the program	86
8.4	ODS configuration software main window	88
8.5	Configuration window.....	90
8.5.1	Description of the command buttons.....	91

9	Specifications ODSL 9	92
9.1	Optical data and certifications	92
9.2	Electrical data, installation data	93
9.3	Dimensioned and connection drawings	94
10	Specifications ODS... 96B/ODK... 96B	97
10.1	Optical data and certifications for triangulation sensors	97
10.2	Optical data and certifications for time-of-flight sensors	99
10.3	Electrical data, installation data: triangulation sensors	100
10.4	Electrical data, installation data: time-of-flight sensors	101
10.5	Dimensioned and connection drawings	102
11	Type overview and accessories	108
11.1	ODSL 9 type overview	108
11.2	ODS... 96B/ODK... 96B type overview	110
11.2.1	Triangulation sensors	110
11.2.2	Time-of-flight sensors	112
11.3	Accessory connection cables and connectors for ODSL 9/OD... 96B.....	113
11.4	Accessory mounting systems for ODSL 9/OD... 96B	114
11.5	Additional accessories for ODSL 9/OD... 96B.....	115

Bild 2.1:	Laser exit openings, Laser warning signs	13
Bild 2.2:	Laser warning and information signs – supplied stick-on labels	14
Bild 2.3:	Laser warning and information signs – supplied stick-on labels	15
Bild 4.1:	Indicator and operating elements of the ODSL 9	18
Bild 4.2:	Application example: wood width measurement with the ODSL 9	19
Bild 4.3:	Application example: installation check with the ODSL 9	20
Bild 4.4:	Behavior of the ODSL 9 analog output (factory setting)	22
Bild 4.5:	Serial transmission formats ODSL 9	27
Bild 4.6:	Voltage divider for the RS 485 bus termination	30
Bild 4.7:	Behavior of the switching outputs ODSL 9/66	32
Bild 5.1:	Display and operational controls ODS... 96B/ODK... 96B	34
Bild 5.2:	Application example: fill level measurement with ODS 96B (TRI)	35
Bild 5.3:	Application example: stack height measurement with ODSL 96B (TRI)	36
Bild 5.4:	Application example: robot arm positioning with ODSL 96B "S" (TRI)	37
Bild 5.5:	Application example: lateral stack positioning with ODSL 96B "XL" (TRI)	38
Bild 5.6:	Application example: slack control for material on drums with ODSL 96B (TOF)	39
Bild 5.7:	Application example: positioning of side-tracking skates with ODKL 96B (TOF)	40
Bild 5.8:	Behavior of the ODS(R) 96B M/C and M/V analog output (factory setting)	43
Bild 5.9:	Behavior of the analog output on the triangulation laser model (factory setting)	44
Bild 5.10:	Behavior of analog output of the time-of-flight laser model (factory setting)	45
Bild 5.11:	ODS... 96B/ODK... 96B M/D serial transmission formats	50
Bild 5.12:	Voltage divider for the RS 485 bus termination	53
Bild 5.13:	Behavior of the switching outputs ODS... 96B/ODK... 96B M/66	55
Bild 6.1:	Preferred direction of entry of the objects when using triangulation sensors	57
Bild 6.2:	Preferred mounting of triangulation sensors for structured surfaces	57
Bild 6.3:	View through a chase	57
Bild 6.4:	Alignment to measurement objects with reflecting surfaces	58
Bild 7.1:	Indicator and operating elements	59
Tabelle 7.1:	LED function indicator	60
Tabelle 7.2:	Input menu	64
Tabelle 7.3:	Menu Output Q1	65
Bild 7.2:	Behavior of the switching outputs	65
Tabelle 7.4:	Menu Output Q2	66
Tabelle 7.5:	Analog Output menu	67
Tabelle 7.6:	Serial menu	68
Tabelle 7.7:	Application menu	69
Tabelle 7.8:	Settings menu	72
Bild 7.3:	Teach signal curve for time-of-flight sensors	78
Tabelle 7.11:	Effects of the measurement modes for triangulation sensors	79
Tabelle 7.12:	Effects of the measurement modes for time-of-flight sensors	79
Tabelle 7.13:	Effects of Measure Filter	80
Bild 8.1:	Connecting the distance sensor via the UPG 10 configuration adapter	85
Bild 8.2:	System variable "devmgr_show_nonpresent_devices"	87
Bild 8.3:	COM port properties - connection settings "Advanced"	87
Bild 8.4:	ODS configuration software - main window	88
Bild 8.5:	ODS configuration software - measurement	89
Bild 8.6:	ODS configuration software - configuration window	90
Bild 9.1:	Dimensioned drawing ODSL 9...	94
Bild 9.2:	Electrical connection ODSL 9/C6...	95

Bild 9.3:	Electrical connection ODSL 9/C66.....	95
Bild 9.4:	Electrical connection ODSL 9/V6.....	95
Bild 9.5:	Electrical connection ODSL 9/V66.....	95
Bild 9.6:	Electrical connection ODSL 9/L.....	96
Bild 9.7:	Electrical connection ODSL 9/D26.....	96
Bild 9.8:	Electrical connection ODSL 9/D36.....	96
Bild 9.9:	Electrical connection ODSL 9/66.....	96
Bild 10.1:	Dimensioned drawing ODS 96B... ODSR 96B.....	102
Bild 10.2:	Dimensioned drawing triangulation sensors ODSL(R) 96B.....	103
Bild 10.3:	Dimensioned drawing time-of-flight sensors ODSL 96B.../ODKL 96B.....	104
Bild 10.4:	Dimensioned drawing of ODSIL 96B... time-of-flight sensors.....	105
Bild 10.5:	Electrical connection ODS... 96B/ODK... 96B M/C.....	106
Bild 10.6:	Electrical connection ODS... 96B/ODK... 96B M/C66.....	106
Bild 10.7:	Electrical connection ODS... 96B/ODK... 96B M/V.....	106
Bild 10.8:	Electrical connection ODS... 96B/ODK... 96B M/L.....	106
Bild 10.9:	Electrical connection ODS... 96B/ODK... 96B M/D26.....	107
Bild 10.10:	Electrical connection ODS... 96B/ODK... 96B M/D36.....	107
Bild 10.11:	Electrical connection ODS... 96B/ODK... 96B M/66.....	107
Tabelle 11.1:	ODSL 9 type overview.....	108
Tabelle 11.2:	Type overview triangulation sensors ODS... 96B.....	110
Tabelle 11.3:	Type overview time-of-flight sensors OD...L 96B.....	112
Tabelle 11.4:	Accessory connection cables and connectors.....	113
Tabelle 11.5:	Accessory mounting systems.....	114
Tabelle 11.6:	Accessories for PC configuration / IO-Link / fieldbus connection.....	115

1 General information

1.1 Explanation of symbols

The symbols used in this technical description are explained below.



Attention

This symbol precedes text messages which must strictly be observed. Failure to comply with this information results in injuries to personnel or damage to the equipment.



Attention Laser Radiation

This symbol warns of possible danger caused by hazardous laser radiation.





Notice

This symbol indicates text passages containing important information.



Notice

According to their measurement principle, this manual also refers to the sensors in brief as triangulation sensors and as time-of-flight sensors and partly distinguishes them in the text by means of different colors:

-  **TRI** = triangulation sensors
-  **JLTOF** = time-of-flight sensors

1.2 Important terms

Absolute measurement accuracy

Shows the possible divergence of the measurement value from the anticipated value through changes in the environmental conditions during the measuring process. Accuracy is increased under constant environmental conditions.

Response time

The time period required to obtain stable measurements after change of the reflectivity behavior. In the case of sensors with the time-of-flight measurement principle, the response time equals the measurement time.

Resolution

The smallest possible distance change of the measurement object, which causes a definite change in the output signal. For sensors with triangulation measurement principle, the short range resolution exceeds that at distant range. Objects at short range can be measured with higher accuracy.

Warmup time

Time the sensor needs in order to reach the operating temperature. The warmup time is around 20min (depending on the sensor type). An optimal measurement is only possible after the end of the warmup time.

Output resolution

The output resolution describes how the measurement values are presented on the display and digital interfaces. The output resolution (0.01 mm, 0.1 mm or 1 mm) is set for each sensor type and cannot be changed.

Delay before start-up

The delay before start-up indicates the point in time when the first valid measurement can be obtained after switching on.

Insensitivity towards ambient light

Indicates the insensitivity of the measurement result towards ambient light. Sensors with triangulation measurement principle (**TRI**) also measure reliably with external light interference of 5kLux (ODS... 96B) or 30kLux (ODSL 9), while the typical light intensity in the workplaces is only about 1kLux. Sensors with time-of-flight measurement principle (**JLTOF**) feature a significantly higher immunity against external light interference of about 100kLux. The immunity against external light interference of triangulation sensors may be improved significantly via the **Ambient Light Suppression** mode (abt. 30kLux).

Light switching / Dark switching

Indicates the behavior of the switching output when an object is inside the taught/configured switching distance. At light switching, the switching output is active (high), at dark switching inactive.

Integration time

The integration time for triangulation sensors is comparable to the exposure time for photographic cameras. It is automatically adjusted to the intensity of the reflected light and thus depends on the reflectance factor of the measurement object. It is inversely proportional to the measurement frequency. Triangulation sensors by Leuze electronic automatically adjust themselves for optimum integration time.

Measurement time

The measurement time indicates the time difference between 2 consecutive measurements. For triangulation sensors, the measurement time changes as a result of the adaptation of the integration time in correspondence with the reflectance and the measurement distance.

Diffuse reflection

Return and/or degree of reflection of the radiated light. Please observe the reflectance values in the respective specifications (90% is white, 6% is black). In the case of sensors with the time-of-flight measurement principle, the measurement range depends on the reflectance.

Time of Flight 

Distance measurement procedures that determines the distance of an object via the propagation time of a light pulse emitted by the sensor's transmitter that is reflected by the object and received by the sensor's receiver. For large operating ranges, high immunity against light interference and low influence of gloss and structures on the measurement value.

Triangulation 

Distance measuring procedure, which determines the distance of an object by the incidence angle of the light reflected from the object. For short to medium operating ranges, fast measurement rate, high accuracy.

Repeatability

Measuring distance change with repeated measurement at the same output signal (observe the same peripheral conditions as with resolution).

1.3 Declaration of conformity

The optical distance sensors of the ODS.../ODK... series have been manufactured observing current European standards and guidelines.

**Notice**

A corresponding Declaration of Conformity can be requested from the manufacturer.

The manufacturer of the product, Leuze electronic GmbH + Co. KG in D-73277 Owen, possesses a certified quality assurance system in accordance with ISO 9001.



2 Safety

This sensor was developed, manufactured and tested in accordance with the applicable safety standards. It corresponds to the state of the art.

2.1 Proper use

The ODS... distance sensors are optical electronic sensors for the optical, contactless measurement of distance to objects.

Areas of application

The optical distance sensors of the ODS... series have been designed for the following areas of application:

- distance measurement
- contour determination
- thickness measurement
- positioning
- filling level measurement
- diameter determination
- sag determination and much more.



CAUTION

Operate in accordance with intended use.

☞ Only operate the device in accordance with its intended use.

The protection of personnel and the device cannot be guaranteed if the device is operated in a manner not corresponding to its intended use.

Leuze electronic GmbH + Co. KG is not liable for damages caused by improper use.

☞ Read the technical description before commissioning the device.

Knowledge of this technical description is an element of proper use.

NOTICE

Comply with conditions and regulations!

☞ Observe the locally applicable legal regulations and the rules of the employer's liability insurance association.

OPERATION NOTICE IN ACCORDANCE WITH UL CERTIFICATION:

CAUTION – Use of controls or adjustments or performance of procedures other than those specified herein may result in hazardous light exposure.

ATTENTION ! Si d'autres dispositifs d'alignement que ceux préconisés ici sont utilisés ou s'il est procédé autrement qu'indiqué, cela peut entraîner une exposition à des rayonnements et un danger pour les personnes.

**Attention**

For UL applications, use is only permitted in class 2 circuits in accordance with the NEC (National Electric Code).

2.2 Foreseeable misuse

Any use other than that defined under the "Approved purpose" or which goes beyond that use is considered improper use.

In particular, use of the device is not permitted in the following cases:

- Rooms with explosive atmospheres
- in circuits which are relevant to safety
- Operation for medical purposes

NOTICE**Do not modify or otherwise interfere with the device.**

- ↳ Do not carry out modifications or otherwise interfere with the device.
The device must not be tampered with and must not be changed in any way.
The device must not be opened. There are no user-serviceable parts inside the device.
Repairs must only be performed by Leuze electronic GmbH + Co. KG.

2.3 Competent persons

Connection, mounting, commissioning and adjustment of the device must only be carried out by competent persons.

Prerequisites for competent persons:

- They have a suitable technical education.
- They are familiar with the rules and regulations for occupational safety and safety at work.
- They are familiar with the technical description of the device.
- They have been instructed by the responsible person on the mounting and operation of the device.

Certified electricians

Electrical work must be carried out by a certified electrician.

Due to their technical training, knowledge and experience as well as their familiarity with relevant standards and regulations, certified electricians are able to perform work on electrical systems and independently detect possible hazards.

In Germany, certified electricians must fulfill the requirements of accident-prevention regulations BGV A3 (e.g. electrician foreman). In other countries, there are respective regulations that must be observed.


2.4 Disclaimer

Leuze electronic GmbH + Co. KG is not liable in the following cases:


- The device is not being used properly.
- Reasonably foreseeable misuse is not taken into account.
- Mounting and electrical connection are not properly performed.
- Changes (e.g., constructional) are made to the device.

2.5 Laser safety notices – Laser class 1

Valid for: ODSL 9/...C1...
 ODSL 96BM/...C1...

	ATTENTION, LASER RADIATION – LASER CLASS 1
<p>The device satisfies the requirements of IEC 60825-1:2007 (EN 60825-1:2007) safety regulations for a product in laser class 1 as well as the U.S. 21 CFR 1040.10 regulations with deviations corresponding to "Laser Notice No. 50" from June 24th, 2007.</p> <p>☞ Adhere to the applicable legal and local regulations regarding protection from laser beams.</p> <p>☞ The device must not be tampered with and must not be changed in any way. There are no user-serviceable parts inside the device. Repairs must only be performed by Leuze electronic GmbH + Co. KG.</p>	

Valid for: ODSIL 96BM/...

	ATTENTION, VISIBLE AND INVISIBLE LASER RADIATION – LASER CLASS 1
<p>The device satisfies the requirements of IEC 60825-1:2007 (EN 60825-1:2007) safety regulations for a product in laser class 1 as well as the U.S. 21 CFR 1040.10 regulations with deviations corresponding to "Laser Notice No. 50" from June 24th, 2007.</p> <p>☞ Adhere to the applicable legal and local regulations regarding protection from laser beams.</p> <p>☞ The device must not be tampered with and must not be changed in any way. There are no user-serviceable parts inside the device. Repairs must only be performed by Leuze electronic GmbH + Co. KG.</p>	

2.6 Laser safety notices – Laser class 2

Valid for: ODSL 9/... without indicator ...C1... in type designation
 ODSL 96BM/... without indicator ...C1... in type designation
 ODSL 96BM/... without indicator ...C1... in type designation
 ODKL 96BM/... without indicator ...C1... in type designation



ATTENTION, LASER RADIATION – LASER CLASS 2

Never look directly into the beam!

The device satisfies the requirements of IEC 60825-1:2007 (EN 60825-1:2007) safety regulations for a product in **laser class 2** as well as the U.S. 21 CFR 1040.10 regulations with deviations corresponding to "Laser Notice No. 50" from June 24th, 2007.

- ↪ Never look directly into the laser beam or in the direction of reflecting laser beams! If you look into the beam path over a longer time period, there is a risk of injury to the retina.
- ↪ Do not point the laser beam of the device at persons!
- ↪ Intercept the laser beam with an opaque, non-reflective object if the laser beam is accidentally directed towards a person.
- ↪ When mounting and aligning the device, avoid reflections of the laser beam off reflective surfaces!
- ↪ CAUTION! Use of controls or adjustments or performance of procedures other than specified herein may result in hazardous light exposure.
- ↪ Adhere to the applicable legal and local regulations regarding protection from laser beams.
- ↪ The device must not be tampered with and must not be changed in any way. There are no user-serviceable parts inside the device. Repairs must only be performed by Leuze electronic GmbH + Co. KG.

NOTICE

Affix laser information and warning signs!

Laser information and warning signs are affixed to the device (see figure 2.1). In addition, self-adhesive laser information and warning signs (stick-on labels) are supplied in several languages (see figure 2.2 and figure 2.3).

- ↪ Affix the laser information sheet with the language appropriate for the place of use to the device.
When using the device in the US, use the stick-on label with the "Complies with 21 CFR 1040.10" notice.
- ↪ Affix the laser information and warning signs near the device if no signs are attached to the device (e.g. because the device is too small) or if the attached laser information and warning signs are concealed due to the installation position.
Affix the laser information and warning signs so that they are legible without exposing the reader to the laser radiation of the device or other optical radiation.

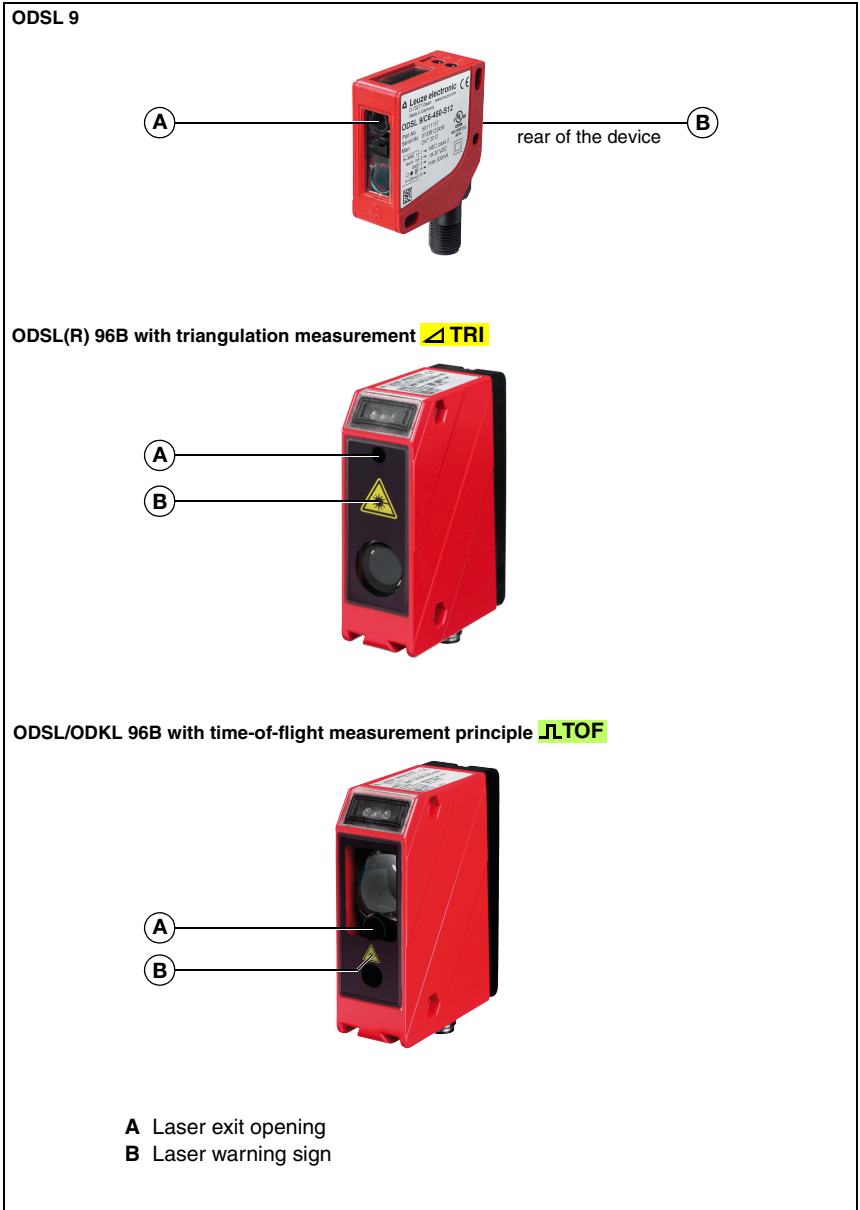



Bild 2.1: Laser exit openings, Laser warning signs

ODSL 9 / ODSL(R) 96B laser class 2, with triangulation measurement 

50106507-05

LASERSTRAHLUNG	
NICHT IN DEN STRAHL BLICKEN	
Max. Leistung (peak):	1,2 mW
Impulsdauer:	22 ms
Wellenlänge:	650 nm
LASER KLASSE 2	
DIN EN 60825-1:2008-05	

RADIAZIONE LASER	
NON FISSARE IL FASCIO	
Potenza max. (peak):	1,2 mW
Durata dell'impulso:	22 ms
Lunghezza d'onda:	650 nm
APPARRECCHIO LASER DI CLASSE 2	
EN 60825-1:2007	

LASER RADIATION	
DO NOT STARE INTO BEAM	
Maximum Output (peak):	1,2 mW
Pulse duration:	22 ms
Wavelength:	650 nm
CLASS 2 LASER PRODUCT	
EN 60825-1:2007	

RAYONNEMENT LASER	
NE PAS REGARDER DANS LE FAISCEAU	
Puissance max. (crête):	1,2 mW
Durée d'impulsion:	22 ms
Longueur d'onde:	650 nm
APPAREIL À LASER DE CLASSE 2	
EN 60825-1:2007	

▲

AVOID EXPOSURE – LASER RADIATION
IS EMITTED FROM THIS APERTURE

▲

EXPOSITION DANGEREUSE – UN RAYONNEMENT
LASER EST ÉMIS PAR CETTE OUVERTURE

RADIACIÓN LÁSER	
NO MIRAR FIJAMENTE AL HAZ	
Potencia máx. (peak):	1,2 mW
Duración del impulso:	22 ms
Longitud de onda:	650 nm
PRODUCTO LÁSER DE CLASE 2	
EN 60825-1:2007	

RADIAÇÃO LASER	
NÃO OLHAR FIXAMENTE O FEIXE	
Potência máx. (peak):	1,2 mW
Período de pulso:	22 ms
Comprimento de onda:	650 nm
EQUIPAMENTO LASER CLASSE 2	
EN 60825-1:2007	

LASER RADIATION	
DO NOT STARE INTO BEAM	
Maximum Output (peak):	1,2 mW
Pulse duration:	22 ms
Wavelength:	650 nm
CLASS 2 LASER PRODUCT	
IEC 60825-1:2007	
Complies with 21 CFR 1040.10	

激光辐射	
勿直视光束	
最大输出 (峰值):	1,2 mW
脉冲持续时间:	22 ms
波长:	650 nm
2 类激光产品	
GB7247.1-2012	





Bild 2.2: Laser warning and information signs – supplied stick-on labels 

14

ODS.../ODK... 9 / 96B


Leuze electronic

ODSL/ODKL 96B laser class 2, with time-of-flight measurement principle JLTOF

50108905-04

LASERSTRAHLUNG	
NICHT IN DEN STRAHL BLICKEN	
Max. Leistung (peak):	248 mW
Impulsdauer:	6,5 ns
Wellenlänge:	658 nm
LASER KLASSE 2	
DIN EN 60825-1:2008-05	


LASER RADIATION	
DO NOT STARE INTO BEAM	
Maximum Output (peak):	248 mW
Pulse duration:	6.5 ns
Wavelength:	658 nm
CLASS 2 LASER PRODUCT	
EN 60825-1:2007	



AVOID EXPOSURE – LASER RADIATION IS EMITTED FROM THIS APERTURE

RADIAZIONE LASER	
NON FISSARE IL FASCIO	
Potenza max. (peak):	248 mW
Durata dell'impulso:	6,5 ns
Lunghezza d'onda:	658 nm
APPARECCHIO LASER DI CLASSE 2	
EN 60825-1:2007	

RAYONNEMENT LASER	
NE PAS REGARDER DANS LE FAISCEAU	
Puissance max. (crête):	248 mW
Durée d'impulsion:	6.5 ns
Longueur d'onde:	658 nm
APPAREIL A LASER DE CLASSE 2	
EN 60825-1:2007	



EXPOSITION DANGEREUSE – UN RAYONNEMENT LASER EST ÉMIS PAR CETTE OUVERTURE

RADIACIÓN LÁSER	
NO MIRAR FIJAMENTE AL HAZ	
Potencia máx. (peak):	248 mW
Duración del impulso:	6,5 ns
Longitud de onda:	658 nm
PRODUCTO LÁSER DE CLASE 2	
EN 60825-1:2007	

RADIAÇÃO LASER	
NÃO OLHAR FIXAMENTE O FEIXE	
Potência máx. (peak):	248 mW
Período de pulso:	6,5 ns
Comprimento de onda:	658 nm
EQUIPAMENTO LASER CLASSE 2	
EN 60825-1:2007	

LASER RADIATION	
DO NOT STARE INTO BEAM	
Maximum Output (peak):	248 mW
Pulse duration:	6.5 ns
Wavelength:	658 nm
CLASS 2 LASER PRODUCT	
IEC 60825-1:2007	
Complies with 21 CFR 1040.10	

激光辐射	
勿直视光束	
最大输出 (峰值):	248 mW
脉冲持续时间:	6.5 ns
波长:	658 nm
2 类激光产品	
GB7247.1-2012	






Bild 2.3: Laser warning and information signs – supplied stick-on labels **JLTOF**

3 The different sensor types

3.1 ODSL 9 with triangulation measurement

The ODSL 9 is an optical distance sensor that operates according to the triangulation measurement principle. Advantages of the ODSL 9:

- For short to medium operating ranges
- High measurement rate
- Very high accuracy
- Measurement against diffusely reflective objects
- Low temperature influence on the measurement value

Overview of sensor features

- Plastic housing with protection class IP 67
- Dimensions 50mm x 50mm x 21mm
- Visible red-light laser
- Operating ranges up to 650mm
- Measurement time 2ms
- Yellow LC display (backlit) for measurement value display and sensor configuration
- Configuration via PC software and programming unit
- 2 short-stroke keys for menu navigation
- 2 device LEDs

3.2 ODS... 96B with triangulation measurement **TRI**

The ODSL 96B is an optical distance sensor that operates according to the triangulation measurement principle. Advantages of the ODS... 96B with triangulation measurement principle:

- For short to medium operating ranges
- High measurement rate
- High accuracy
- Measurement against diffusely reflective objects
- Low temperature influence on the measurement value

Overview of sensor features

- Metal housing with protection class IP 67, IP 69K
- Dimensions 90mm x 70mm x 30mm
- Device models with red-light LED, infrared LED and visible red-light laser
- Operating ranges up to 2000mm (range specification in the type designation)
- Minimum measurement time 1 ms
- OLED display for measurement value display and sensor configuration
- Configuration via PC software and programming unit
- Labeled key pad with 2 buttons for menu navigation
- 2 device LEDs each at the sensor front and back

3.3 ODSL/ODKL/ODSIL 96B with time-of-flight measurement **LTOF**

The ODSL/ODKL/ODSIL 96B is an optical distance sensor that operates according to the time-of-flight measurement principle. Advantages of the time-of-flight measurement principle:

- For large ranges
- High immunity against light interference
- Low influence of gloss and structures on the measurement value
- Measurement against diffusely reflective objects (ODSL/ODSIL 96B) or reflective tapes (ODKL 96B)
- Wide area of application

Overview of sensor features

- Metal housing with protection class IP 67, IP 69K
- Dimensions 90mm x 70mm x 30mm
- Device models with infrared-light laser and visible red-light laser
- Operating ranges up to 10m diffuse or 25m against high gain foil (no range specification in the type designation)
- Minimum measurement time 1.4ms
- OLED display for measurement value display and sensor configuration
- Configuration via PC software and programming unit
- Labeled key pad with 2 buttons for menu navigation
- 2 device LEDs each at the sensor front and back

4 Description ODSL 9

4.1 General description

The ODSL 9 is a distance sensor with an extensive area of application. The devices are available as a laser version with analog output or serial output as well as with 1 to 2 switching outputs. The distance measuring device operates on the triangulation principle and uses a CMOS line for evaluating.

Through automatic adjustment of the integration time (exposure time) to the intensity of the objects' reflected light, a high degree of independence from the reflectivity properties of the measurement object is achieved.

An integrated RISC controller facilitates brief measurement times while at the same time providing highly precise measurement values. The high-performance hardware is also able to preprocess measurement data directly in the sensor.

The standard measurement range lies between 50 ... 450mm. One model for greater ranges covers the measurement range from 50 ... 650mm. Both models have an output resolution of 0.1 mm. Higher resolution models are available with a measurement range of 50 ... 100mm or 50 ... 200mm. Its output resolution is 0.01 mm.

Two short-stroke keys and a backlit LC display are integrated into the device. They allow the ODSL 9 to be configured via a graphical menu. During measurement operation, the display shows the current measurement value. The sensor can be protected against unauthorized operation by password protection.

The configuration software available from www.leuze.com allows configuration of the ODSL 9 products by means of a PC and visualization of the ODSL 9's measurement values. Moreover, stored parameter sets can be duplicated in other distance sensors. The connection is made via the configuration adapter, which is available as an accessory (UPG10).

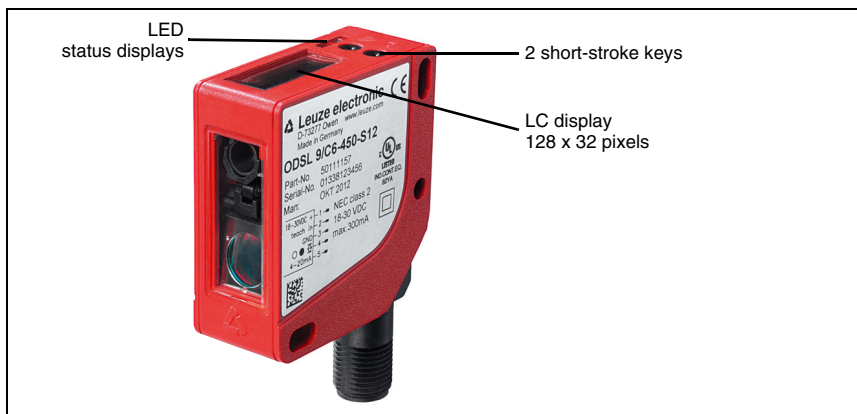


Bild 4.1: Indicator and operating elements of the ODSL 9

Accessories

The configuration software as well as a UPG 10 configuration adapter are available for configuring the ODSL 9 from a PC.

Mounting systems and connection cables in various lengths and configurations round off the accessories.

Details can be found in chapter 11.

4.2 Typical areas of application for the ODSL 9

Typical areas of application for the ODSL 9 are:

- Positioning of actuators and robots
- Height and width measurement as well as determination of diameter
- Quality assurance in assembly lines
- Contour measurement of moving objects

Laser light spot: 1 mm x 1 mm



Application examples



Bild 4.2: Application example: wood width measurement with the ODSL 9



Bild 4.3: Application example: installation check with the ODSL 9



Notice

For mounting instructions please refer to chapter 6.2.

4.3 ODSL 9 variants

Model variations

The ODSL 9 is available as a **laser distance sensor** (red light) . Measurement ranges:
 50...100mm with absolute measurement accuracy $\pm 0.5\%$, resolution 0.01 mm
 50...200mm with absolute measurement accuracy $\pm 0.5 \dots \pm 1.0\%$, resolution 0.01 ... 0.1 mm
 50...450mm with absolute measurement accuracy $\pm 1.0\%$, resolution 0.1 mm
 50...650mm with absolute measurement accuracy $\pm 1.0\%$, resolution 0.1 ... 0.5mm

4.3.1 Type code

Use the following table to determine the equipment features of your ODSL 9.

OD	S	L	9/	V	6.C1	-450	-S12
							Connection type
							S12 M12 connector
							Operating range in mm
							100 50 ... 100mm, High Res., resolution 0.01 mm
							200 50 ... 200mm, resolution 0.01 ... 0.1 mm
							450 50 ... 450mm, resolution 0.1 mm
							650 50 ... 650mm, resolution 0.1 ... 0.5mm
							Laser class
							.C1 laser class 1
							N/A laser class 2
							Switching output
							6 1 push/pull output
							66 2 push/pull outputs
							Measurement data output
							C analog current output
							V analog voltage output
							L IO-Link interface
							D2 serial RS 232 interface
							D3 serial RS 485 interface
							Light source
							L laser
							Target object
							S measurement against diffusely reflective objects
							OD optical distance sensor



Notice

According to their measurement principle, this manual also refers to the sensors in brief as triangulation sensors and as time-of-flight sensors and partly distinguishes them in the text by means of different colors:

- **TRI** = triangulation sensors
- **JLTOF** = time-of-flight sensors

4.4 ODSL 9/C or /V with analog output

Characteristic output curve of the ODSL 9

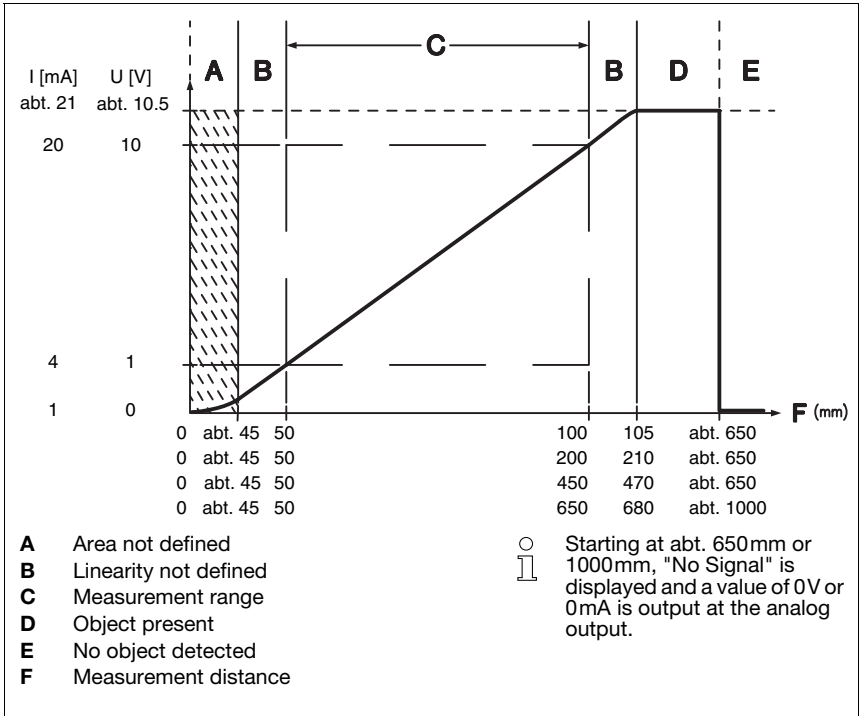


Bild 4.4: Behavior of the ODSL 9 analog output (factory setting)

Response of the analog output

The ODSL 9 M/C or M/V has an analog output with linear behavior inside of the respective measurement range. There is a departure from linearity above and below the linear area. If a signal is present, output values above the maximum ($> 20\text{mA}$ or $> 10\text{V}$) or below the minimum ($< 4\text{mA}$ or $< 1\text{V}$) specified for the measurement range can still be detected.

For ODSL 9 models with voltage output, it is also possible to set the voltage range of the output.

The analog output can be easily configured using the LC display or via software. In order to achieve the highest resolution possible, the range of the analog output should be set as small as the application allows. The characteristic output curve can be configured with a positive or negative gradient. For this purpose, both distance values `Position Min. Val.` and `Position Max. Val.` for the minimum and maximum analog output value are set accordingly, see figure 4.4.

Alternatively, the analog output can also be taught via pin 2 (see chapter "Teach-in of the switching outputs/characteristic output curve (time control)").

Behavior of the switching output

In addition, a switching output is also available with the ODSL 9 M/C and M/V. The position within the measuring range at which the switching output becomes active can be set arbitrarily via a teach line or via configuration. In addition to the switching point, it is also possible to set the switching hysteresis and switching behavior (light/dark switching) using the short-stroke keys or the configuration software.

Teach-in of the characteristic output curve

In addition to edge-controlled **teach-in of the switching outputs** (slope control), the ODSL 9 with analog output can also be used to perform a time-controlled **teach-in of switching output and characteristic output curve** (time control) via the teach line. Both teach events are described in chapter 7.3.

4.5 ODSL 9/L with IO-Link interface

The sensors are equipped with an IO-Link interface for measurement data output. The sensor cyclically transfers a data packet of 2 bytes at a baud rate of 38.4 k (COM2, Frame 2.2, Vers. 1.0) to the IO-Link master module. The sensor has no switching output; the SIO mode is not supported.

The process data and parameters are described in the IODD (IO-Link Device Description). You can download the IODD on the Internet from www.leuze.com.

The ODSL 9/L... can be configured on the PC with a generic IODD interpreter. To do this, the PC is connected to the PC via an IO-Link master.

4.5.1 IO-Link process and service data

IO-Link process data

Output data device

Data bit															
A15	A14	A13	A12	A11	A10	A9	A8	A7	A6	A5	A4	A3	A2	A1	A0
MSB	16 bit measurement value														LSB

16 bit measurement value: distance

1 bit output resolution: 0.01 mm/0.1 mm (type dependent)

Signal too weak: 65535

Laser error: 65533

IO-Link service data

Sensors with IO-Link interface can be configured and diagnosed via the service data.

Measure mode parameter

With this parameter, a measure mode can be activated for adapting to the application task. There are four measurement modes (**Standard**, **Precision**, **Speed** and **Light Suppression**) to choose from.

Measure filter parameter

With this parameter, a measurement value filter can be activated for adapting to the application task. Three options are available (**Off**, **Averaging** and **Center Value**).



Notice

Detailed information on the parameters can be found in chapter 7.

4.5.2 IO-Link system commands and diagnostics (observation)

System commands

Laser transmitter activation

This system command switches on the laser transmitter.

Laser transmitter deactivation

This system command switches off the laser transmitter.

If the sensor is deactivated, then the most recently determined measurement value is frozen. The state of the laser can be monitored in the sensor state.

Setting to factory setting

This system command restores the factory settings of the sensor.

Diagnostics (observation)

Signal too weak [process value 65535] or laser error [process value 65533]

Reception signal is not sufficient: Either no object is in the measurement range or the signal from the object is too low for measurement. A displayed laser error indicates a laser-light source malfunction.

Signal warning

Low reception signal: The object is not detected reliably, e.g. because the signal from the object is very weak.

Laser activation

Status information on whether the laser transmitter is activated or deactivated.

Measurement range sensor

Status information on whether an object is located in the measurement range of the sensor.



Notice

If parameters are changed on the device via the display and keyboard, it is not signaled to the master. When there is an explicit query by the master, however, the changed value is available.



Notice

Detailed information about the IO-Link service data and the IODD can be found at www.leuze.com.

4.6 ODSL 9/D with serial interface

The ODSL 9/D... sensors are equipped with one switching output and one serial interface, which is implemented either as an RS 232 interface (ODSL 9/D2...) or as an RS 485 interface (ODSL 9/D3...).

The transmission rate can be set to between 9,600 and 57,600 baud.

Serial transmission is performed with **1 start bit, 8 data bits and 1 stop bit without parity**.

For the transmission of the measurement values, 4 different transmission modes may be configured (see figure 4.5):

- **ASCII measurement value**
(6 bytes)
- **14-bit measurement value**
(2 bytes, ODS 96 compatible)
- **16-bit measurement value**
(3 bytes, ODSL 30 compatible)
- **Remote control operation**

4.6.1 Measurement value output for various transmission types

Object distance	Measurement value output
No evaluable receive signal	65535 (signal too weak)
< Measurement range	Distance value (undefined linearity)
Within measurement range	Distance value linear
> Measurement range	Distance value (undefined linearity)
Device error	65333 (laser error)

Measurement value ASCII transmission

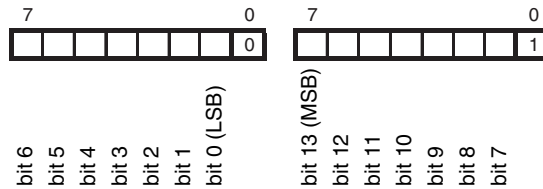
Transmission format: **MMMMM<CR>**

- MMMMM** = 5-digit measurement value in 0.1 mm (for 0.1 mm output resolution)
or = 5-digit measurement value in 0.01 mm (for 0.01 mm output resolution)
- <CR>** = ASCII character "Carriage Return" (x0D)

Measurement value = 14 bit

output resolution 0.01 mm/0.1 mm (type dependent)

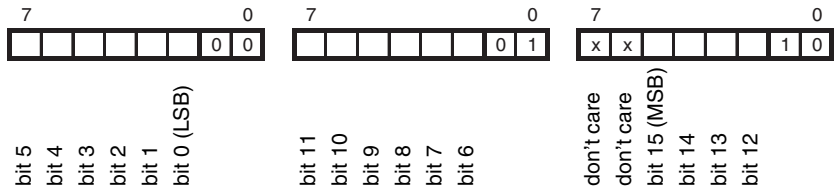
- 1. Low Byte (bit 0 = 0)
- 2. High Byte (bit 0 = 1)



Measurement value = 16 bit

output resolution 0.01 mm/0.1 mm (type dependent)

- 1. Low Byte (bit 0 = 0, bit 1 = 0)
- 2. Middle Byte (bit 0 = 1, bit 1 = 0)
- 3. High Byte (bit 0 = 0, bit 1 = 1)



Remote control operation

ASCII transfer of the measurement value on request
4 digits (4 bytes) **or 5 digits** (5 bytes).

Bild 4.5: Serial transmission formats ODSL 9

4.6.2 Commands for remote control operation

For remote-control operation (Serial -> Com Function -> Remote control), a device address can be set between 0 and 14 (Serial -> Node Address).

In this operating mode, the ODSL 9/D only responds to commands from the control. The following control commands are available:

Measurement value query, 4 digits:

	Byte no.									Response time	
	0	1	2	3	4	5	6	7	8		
Command	Sensor address 0x00 through 0x0E	-	-	-	-	-	-	-	-	-	
Sensor response	"*#" (0x2A)	ASCII address tens	ones	ASCII distance measurement value 1'000's 100's			tens	ones	"##" (0x23)	-	max. 15ms

Measurement value query, 5 digits:

	Byte no.									Response time	
	0	1	2	3	4	5	6	7	8		
Command	"*#" (0x2A)	ASCII address "0...9", "A...D"	"M" (0x4D)	"##" (0x23)	-	-	-	-	-		
Sensor response	"*#" (0x2A)	ASCII address "0...9", "A...D"	ASCII distance measurement value 10'000's 1'000's 100's				tens	ones	State	"##" (0x23)	max. 15ms

Execute referencing function:

	Byte no.									Response time
	0	1	2	3	4	5	6	7	8	
Command	"*#" (0x2A)	ASCII address "0...9", "A...D"	"R" (0x52)	"##" (0x23)	-	-	-	-	-	
Sensor response	"*#" (0x2A)	ASCII address "0...9", "A...D"	State	"##" (0x23)	-	-	-	-	-	max. 2s

Detailed information on referencing can be found in chapter 7.8.2

Execute preset measurement:

	Byte no.									Response time
	0	1	2	3	4	5	6	7	8	
Command	"*#" (0x2A)	ASCII address "0...9", "A...D"	"P" (0x52)	"##" (0x23)	-	-	-	-	-	
Sensor response	"*#" (0x2A)	ASCII address "0...9", "A...D"	State	"##" (0x23)	-	-	-	-	-	max. 2s

Detailed information on Preset/Offset can be found in chapter 7.8.1

Activate sensor:

	Byte no.									Response time
	0	1	2	3	4	5	6	7	8	
Command	"*" (0x2A)	ASCII address "0...9", "A...D"	"A" (0x41)	"#" (0x23)	-	-	-	-	-	
Sensor response	"*" (0x2A)	ASCII address "0...9", "A...D"	State	"#" (0x23)	-	-	-	-	-	max. 15 ms

Deactivate sensor:

	Byte no.									Response time
	0	1	2	3	4	5	6	7	8	
Command	"*" (0x2A)	ASCII address "0...9", "A...D"	"D" (0x44)	"#" (0x23)	-	-	-	-	-	
Sensor response	"*" (0x2A)	ASCII address "0...9", "A...D"	State	"#" (0x23)	-	-	-	-	-	max. 15 ms

Status byte (bitwise processing):

Bit number	Meaning
7 (MSB)	always = 0 (reserved)
6	1 = other error (e.g. no measurement possible or referencing / preset not successful), 0 = OK
5	always = 1
4	always = 0 (reserved)
3	always = 0 (reserved)
2	1 = sensor deactivated, 0 = sensor activated
1	1 = no signal or signal too low, 0 = signal OK
0 (LSB)	1 = laser interference, 0 = Laser OK

4.6.3 Termination of the data lines of the ODSL 9/D3...

The ODSL 9/D3... features a combined transmitter and receiver component that can transmit serial data according to the RS 485 and RS 422 standard (see TIA/EIA-485-A or DIN66259, Part 3).

These standards define some basic rules that should be followed in order to achieve the most reliable data transmission:

- The data lines A and B (which correspond to the ODSL 9 pins Tx+ and Tx-) are connected to an intrinsic impedance of $Z_0 \approx 120\Omega$ via a 2-wire twisted pair cable.
- The end of the data line (and the beginning in case of RS 485) is terminated using a 120Ω resistor. The ODSL 9/D3... does not have an internal bus termination.
- The RS 485 bus participants are wired in an in-line bus topology, i.e., the data line is fed from one bus participant to the next. Cable stubs are to be avoided or to be kept as short as possible.
- The RS 485 specification assumes an inactive potential difference of $U_{AB} \geq 200\text{mV}$ between the data lines. A bus termination in the form of a voltage divider should be implemented in order to maintain this level. Usually, it is connected to the RS 485 coupling module of the PLC.

The RS 485 specification permits transmission rates in the megabit range for up to 32 participants. The ODSL 9/D3... is designed for a data transmission rate of typically 9600 baud (9600 ... 57600 baud may be configured). In practice, this means that the strict requirements regarding the bus termination and the cabling are "softened" for a few bus participants.

However, it is important to maintain the bus idle levels ($U_{AB} \geq 200\text{mV}$). If the PLC coupling module does not include a bus termination with voltage divider, the following circuit may be used.

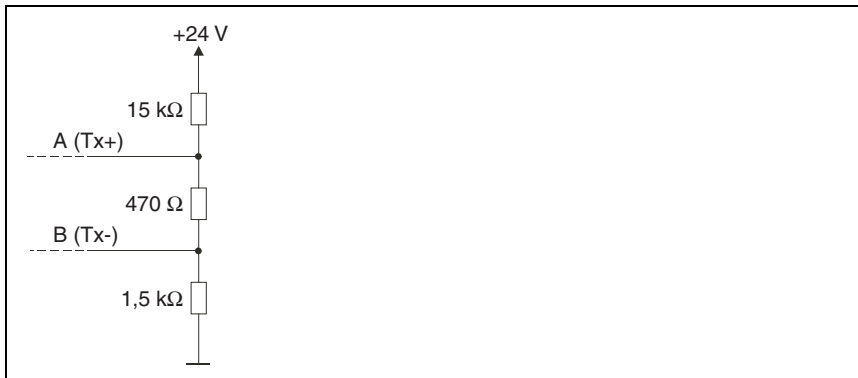


Bild 4.6: Voltage divider for the RS 485 bus termination

The RS 422 connection does not require a bus termination for cable lengths up to about 20m and data transmission rates less than 9600 Baud.

Further information:

- RS 422: Electrical Specification acc. to DIN 66259, Part 3
- ISO 8482: Abstract
Specifies the physical medium characteristics for twisted pair multipoint interconnections in either 2-wire or 4-wire network topology, a binary and bi-directional signal transfer, the electrical and mechanical design of the endpoint system branch cables and the common trunk cable which may be up to 1200m in length, the component measurements of the integrated type generators and receivers within the endpoint system, the applicable data signaling rate up to 12.5Mbit/s.

4.6.4 Operation on the fieldbus and the Ethernet

ODSL 9/D2 sensors... with an RS 232 serial interface can be connected with MA 2xxi modular interfacing units to the following fieldbus and Ethernet types:

- PROFIBUS DP → **MA 204i**
- Ethernet TCP/IP → **MA 208i**
- CANopen → **MA 235i**
- EtherCAT → **MA 238i**
- PROFINET-IO → **MA 248i**
- DeviceNet → **MA 255i**
- EtherNet/IP → **MA 258i**

To do this, the modular interfacing unit is connected to the sensor via a connection cable. To operate the distance sensors, rotary switch **S4** of the modular interfacing unit must be set to switch position **B**.

Further details can be found in the technical descriptions of the modular interfacing units.



Notice

The default settings of the ODS serial interface have to be adjusted. Further information on configuration of the interface can be found in the technical description of the corresponding device.

Specifications for the serial interface

COM function: ASCII

Baud rate: 38400 baud

The ODSL 9/D2... is to be operated in the "Precision" measure mode. The mode is set through the display menu via `Application -> Measure mode -> Precision` (see chapter 7.2.6).

4.7 ODSL 9/66 with two switching outputs

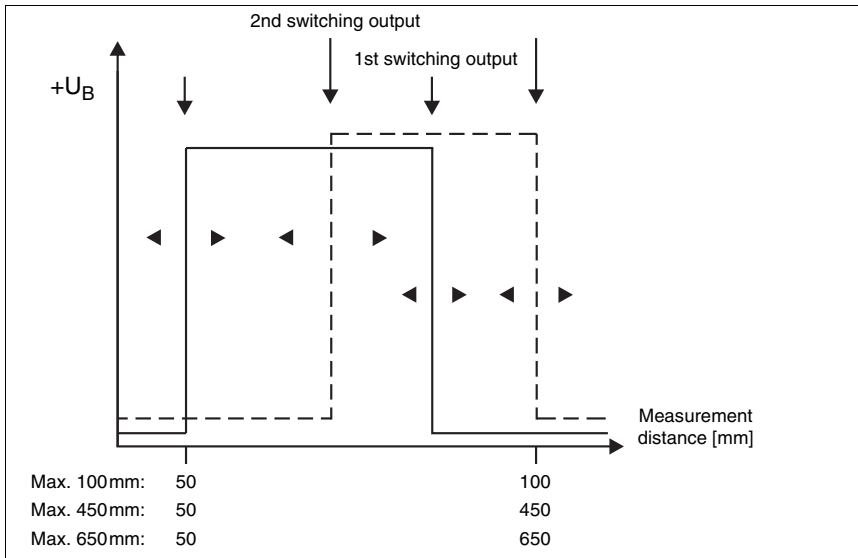


Bild 4.7: Behavior of the switching outputs ODSL 9/66

The two switching outputs of the ODSL 9/66 work independently of each other. Upper and lower switching points as well as hysteresis can be set separately for both switching outputs via the LC display or the configuration software.

Via the teach input, either the upper or the lower measurement range limit can be taught for both switching outputs or, alternatively, the center of the switching range. A common teach line is available for both switching outputs. An exact description of the teach event can be found in chapter 7.3.

5 Description ODS... 96B/ODK... 96B

5.1 General description

The ODS... 96B/ODK... 96B is a distance sensor with a large area of application. The devices are available as LED or laser version with analog or serial output. Two different measurement principles are applied:

Measurement principle: Triangulation

When using the triangulation measuring procedure, the distance of an object is determined via the angle of incidence of the light reflected by the object. For the actual measurement, a linear CMOS array is used. The measurement principle is suitable for medium operating ranges and permits a fast measurement rate and high accuracy.

Through automatic adjustment of the integration time (exposure time) to the intensity of the objects' reflected light, a high degree of independence from the reflectivity properties of the measurement object is achieved. In case of low reflectivity (dark objects) a longer measurement time results. The sensor sets the measurement time automatically.

The measurement range extends from 60 - 2,000mm (depending on sensor model).

Measurement principle: time-of-flight

In the time-of-flight measurement procedure, the distance of an object is determined via the propagation time of a light pulse emitted by the sensor's transmitter that is reflected by the object and received by the sensor's receiver. The measurement principle is suitable for large operating ranges with simultaneous immunity to light interference and a low influence of gloss and structures on the measurement value. The measurement time can be adjusted via the configuration software or via membrane keyboard and OLED display. It remains fixed.

The measurement range extends from 300 - 25,000mm (depending on sensor model).





Notice

The type designation indicates which measurement principle your sensor uses:

- **Sensors with triangulation measurement principle include an operating range specification in the type designation. Example: ODSL 96B M/C6-2000-S12.**
- **Sensors with time-of-flight measurement principle do not include an operating range specification in the type designation. Example: ODSL 96B M/C6-S12.**

According to their measurement principle, the sensors are in the following also referred to in brief as triangulation sensors and as time-of-flight sensors and are partly distinguished in the text by means of different colors:

-  = triangulation sensors
-  = time-of-flight sensors

All device models feature an integrated RISC controller for brief measurement times with simultaneous high precision measurement values. The high-performance hardware is also able to preprocess measurement data directly in the sensor.

A key pad and an OLED display are integrated into the device, which allow the ODS... 96B/ODK... 96B to be configured via a graphical menu. During measurement operation, the display shows the current measurement value. A lockable cover on the back of the ODS... 96B/ODK... 96B and password protection safeguard the sensor against unauthorized operation.

The configuration software available from www.leuze.com allows configuration of the ODS... 96B/ODK... 96B sensors with a PC and visualization of the measured values. Moreover, stored parameter sets can be duplicated in other distance sensors. The connection is made via the configuration adapter, which is available as an accessory (UPG10).



Bild 5.1: Display and operational controls ODS... 96B/ODK... 96B

Accessories

A configuration software as well as a UPG 10 configuration adapter are available for configuring the ODS... 96B/ODK... 96B from a PC.

The housing dimensions of the ODS... 96B/ODK... 96B distance sensors are identical to those of the sensors of the 96 series from Leuze electronic. In particular, the mounting accessories of the 96 series can be used for the ODS... 96B/ODK... 96B.

For ODKL 96B sensors, a special high-gain reflective tape is available.

Mounting systems and connection cables in various lengths and configurations round off the accessories.

Details can be found in chapter 11.


5.2 Typical areas of application for the ODS... 96B/ODK... 96B

Due to the high number of sensor models and light spot geometries, the ODS... 96B/ODK... 96B is suitable for nearly all areas of application.



Notice

For mounting instructions please refer to chapter 6.2.

ODS 96B with infrared or red-light LED, measurement range 100 ... 1400mm ():

- Measurement on large surface objects, e.g., bulk material, material on drums, sheet material
- brightVision® – very bright light spot with LED red light

LED light spot: 15mm x 15mm

Output resolution: 0.1mm



Application example

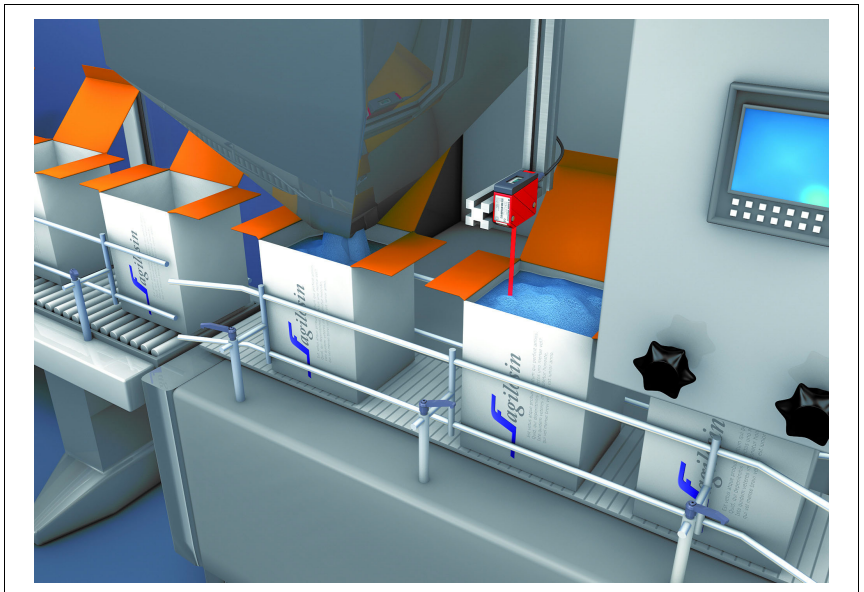


Bild 5.2: Application example: fill level measurement with ODS 96B (TRI)

ODSL 96B with laser, measurement range 60 ... 2000mm ( TRI):

- Measurement in millisecond cycles for large operating ranges
- Stable and precise measurement values, even at varying temperatures and object variations

Laser light spot: 2 mm x 6 mm

Output resolution: 1 mm

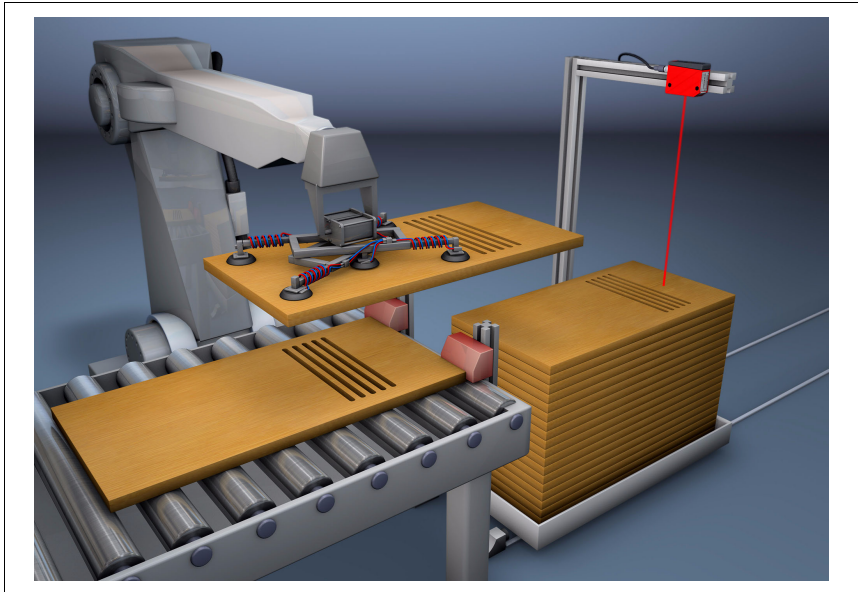
***Application example***

Bild 5.3: Application example: stack height measurement with ODSL 96B (TRI)

ODSL 96B "S" with laser, measurement range 150 ... 800mm ():

- Small laser light spot for the precise measurement onto small objects, metallic surfaces or objects with color structures

Laser light spot: 1 mm x 1 mm

Output resolution: 0.1 mm



Application example

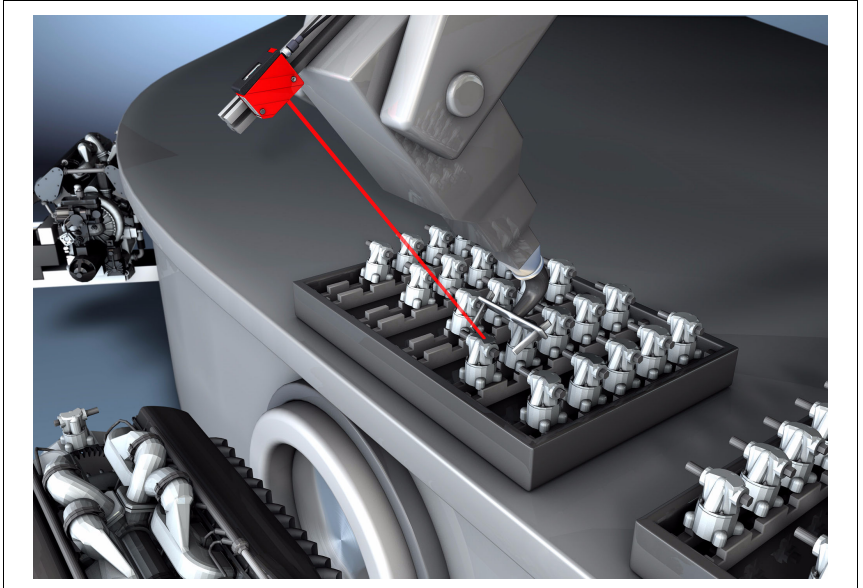


Bild 5.4: Application example: robot arm positioning with ODSL 96B "S" (TRI)

ODSL 96B "XL" with laser, measurement range 150 ... 1200mm ( TRI):

- Elongated light spot for precise measurement on perforated or porous objects (e.g., corrugated cardboard), and on objects that are not precisely aligned

Laser light spot: 15 mm x 4 mm (at 800mm distance)

Output resolution: 0.1 mm

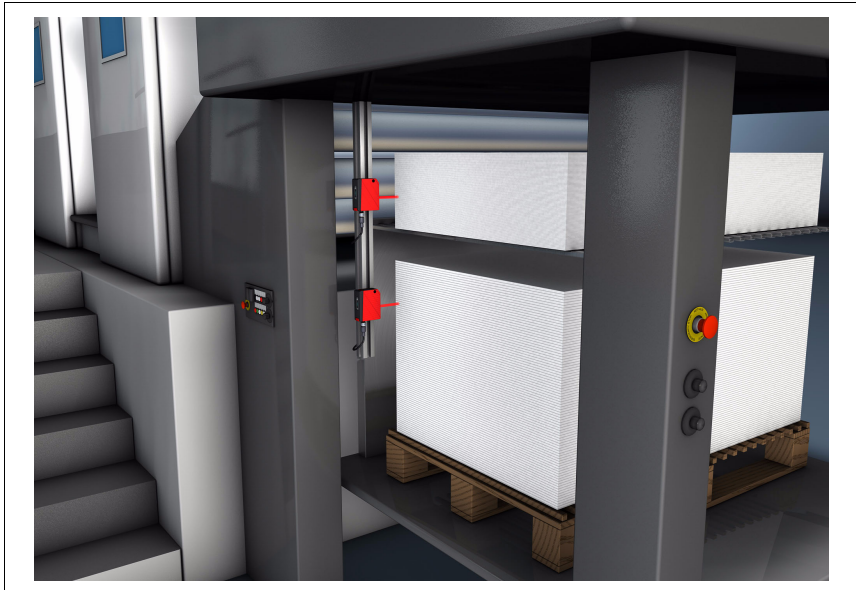
***Application example***

Bild 5.5: Application example: lateral stack positioning with ODSL 96B "XL" (TRI)

ODSL 96B with red-light laser for measurement on objects, measurement range 0.3 ... 10m (**JLTOF):**

- Large operating range, even for dark objects
- Operating modes for fast or precise measurement

Laser light spot: 7 mm x 7 mm (at 10m distance)

Output resolution: 1 mm



ODSL 96B with infrared-light laser for measurement on objects, measurement range 0.3 ... 10m (**JLTOF):**

- Improved measurement behavior on dark objects
- Invisible measurement beam, no influence by people
- Integrated red-light laser alignment aid

Laser light spot: 7 mm x 7 mm (at 10m distance)

Output resolution: 1 mm



Application example

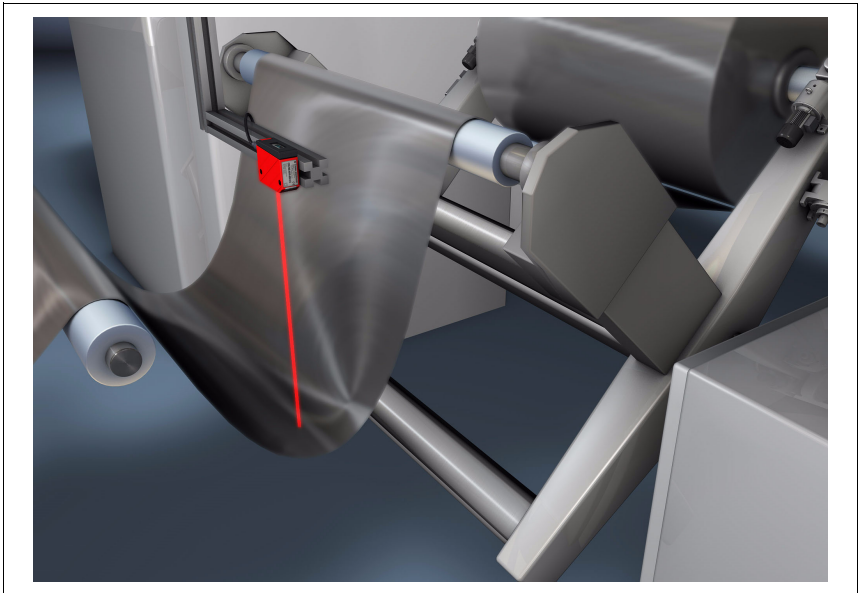


Bild 5.6: Application example: slack control for material on drums with ODSL 96B (TOF)

ODKL 96B with laser for measuring on reflective tape, measurement range 0.3 ... 25m (JLTOF):

- Fast and easy alignment due to well visible laser light spot
- Large operating range in compact design

Laser light spot: 7 mm x 7 mm (at 10m distance)

Output resolution: 1 mm



Application example

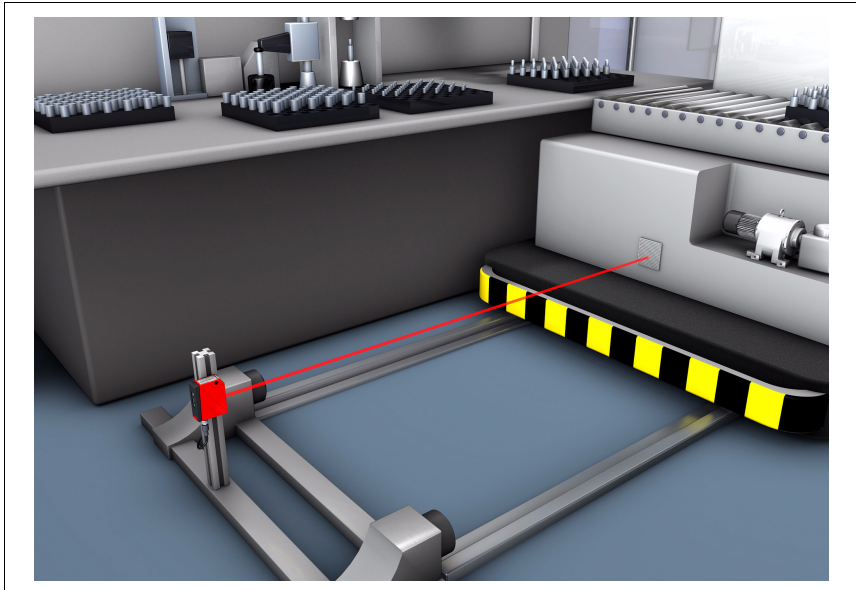


Bild 5.7: Application example: positioning of side-tracking skates with ODKL 96B (TOF)

5.3 ODS... 96B/ODK... 96B variants

Model variations

Five different base variants of the ODS... 96B/ODK... 96B are available:

- as **infrared distance sensor ODS 96B**
 measurement ranges: 100 ... 600mm **TRI**
 120 ... 1400mm **TRI**
- as **red-light distance sensor ODSR 96B**
 measurement range: 100 ... 600mm **TRI**
- as **laser distance sensor** (red light) **ODSL(R) 96B** for measurement against diffusely reflective objects
 measurement ranges: 150 ... 800mm **TRI** (laser, "S" light spot)
 150 ... 1200mm **TRI** (laser, "XL" light spot)
 60 ... 2000mm **TRI** (laser + red-light LED)
 150 ... 2000mm **TRI** (laser)
 300 ... 10,000mm **LTOF** (laser)
- as **laser distance sensor** (infrared light) **ODSIL 96B** for measurement against diffusely reflective objects
 measurement range: 300 ... 10,000mm **LTOF** (laser)
- as **laser distance sensor** (red light) **ODKL 96B** for measurement against high-gain reflective tape
 measurement range: 300 ... 25,000mm **LTOF** (laser against reflective tape)

5.3.1 Part number code

Use the following table to find out the equipment features.

OD SL 96BM/ C 6.C1S -2000-S12

Connection type	S12	M12 connector
	2000	150 ... 2000mm (laser with light spot 2 x 6 mm) 60 ... 2000mm (red-light LED and laser)
	1500	150 ... 1500mm (laser class 1)
	1400	120 ... 1400mm (infrared LED)
	(TRI)	1200 ... 1200mm (laser with light spot 15 x 4 mm)
	800	150 ... 800mm (laser with light spot dia. 1 mm)
	600	100 ... 600mm (infrared LED or red-light LED)
	Without value	300 ... 25,000mm (laser against reflective tape)
	(JLTOF)	300 ... 10,000mm (laser)
	Laser class	.C1S
N/A		laser class 2
Switching output	6	1 push/pull output
	66	2 push/pull outputs
Measurement data output	C	analog current output
	V	analog voltage output
	L	IO-Link interface
	D2	RS 232 serial interface
	D3	RS 485 serial interface
Light source	N/A	infrared LED
	R	red-light LED
	L	red-light laser
	IL	infrared laser
Target object	LR	red-light LED and laser
	S	measurement against diffusely reflective objects
	K	measurement against high-gain reflective tape
	OD	optical distance sensor

5.4 ODS... 96B/ODK... 96B M/C and M/V with analog output

Characteristic output curve of red light/ infrared models

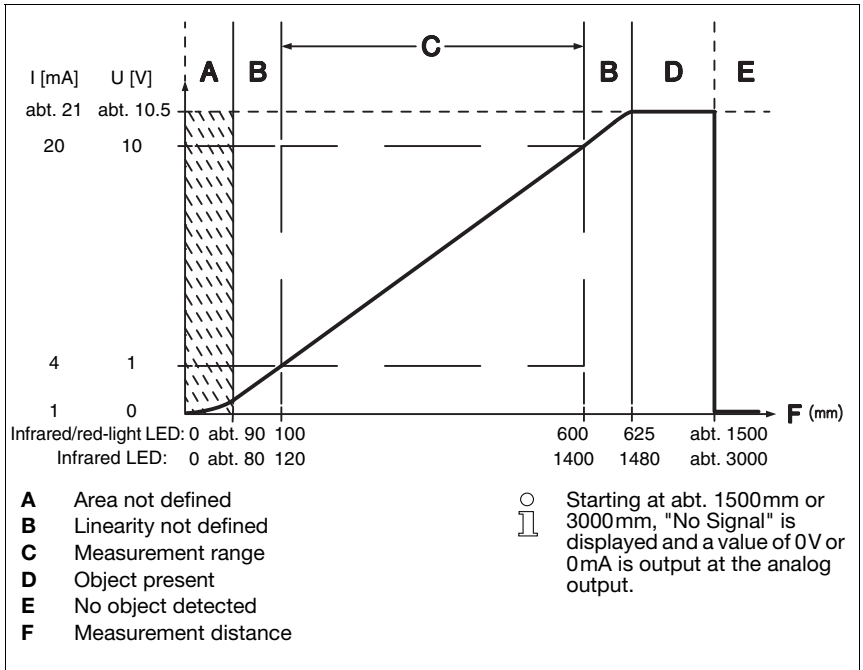


Bild 5.8: Behavior of the ODS(R) 96B M/C and M/V analog output (factory setting)

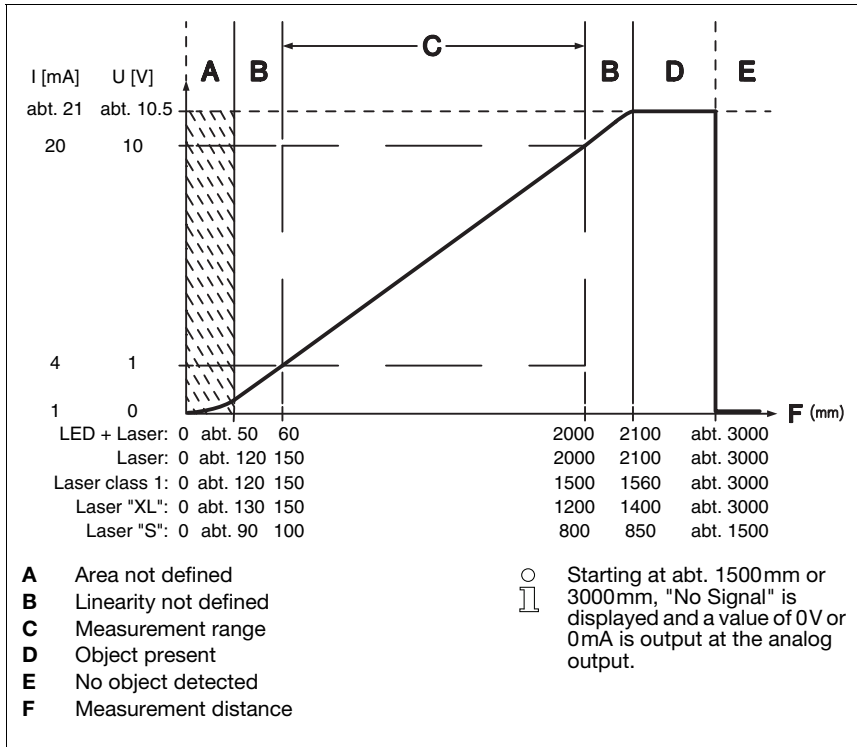
Characteristic output curve of the triangulation laser model **TRI**

Bild 5.9: Behavior of the analog output on the triangulation laser model (factory setting)

Characteristic output curve of the time-of-flight laser model **LTTOF**

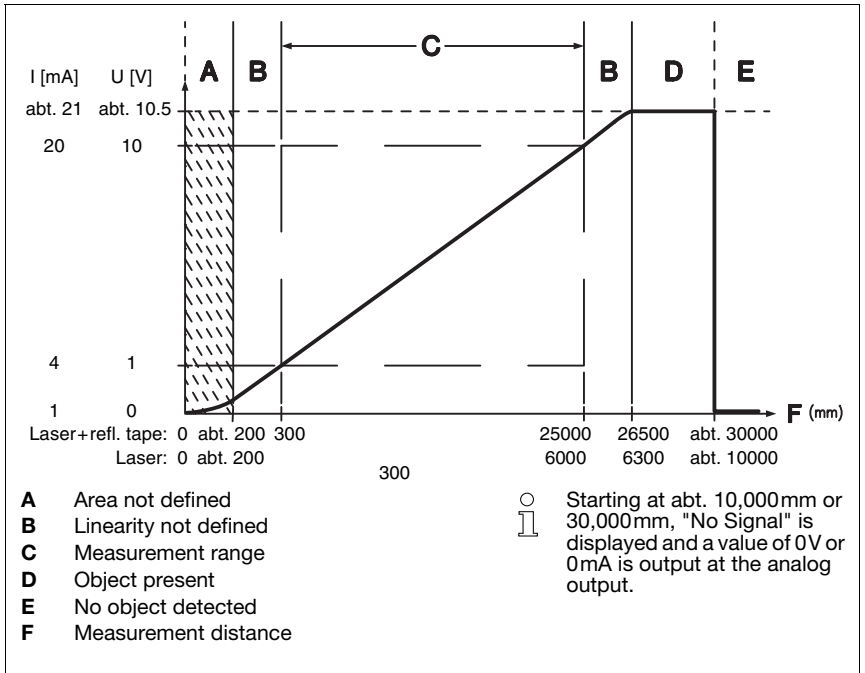


Bild 5.10: Behavior of analog output of the time-of-flight laser model (factory setting)

Response of the analog output

The ODS... 96B/ODK... 96B M/C or M/V has an analog output with linear behavior inside of the respective measurement range. There is a departure from linearity above and below the linear area. If a signal is present, output values above the maximum ($> 20\text{mA}$ or $> 10\text{V}$) or below the minimum ($< 4\text{mA}$ or $< 1\text{V}$) specified for the measurement range can still be detected.

For the models with voltage output, it is also possible to set the voltage range of the output. The analog output can be easily configured using the OLED display or via software. In order to achieve the highest resolution possible, the range of the analog output should be set as small as the application allows. The characteristic output curve can be configured with a positive or negative gradient. For this purpose, the two distance values **Position Min. Val.** and **Position Max. Val.** are set appropriately for the minimum and maximum analog output values, see figure 5.8, figure 5.9 and figure 5.10.

Alternatively, the analog output can also be taught via pin 2 (see chapter 7.3 "Configuration example - lower switching point").

Behavior of the switching output

In addition, a switching output is also available with the ODS... 96B/ODK... 96B M/C and M/V. The position within the measuring range at which the switching output becomes active can be set arbitrarily via a teach line or via configuration. In addition to the switching point, it is also possible to set the switching hysteresis and switching behavior (light/dark switching) using the key pad or the configuration software.

Teach-in of the characteristic output curve

There are different teach methods depending on the device model (**▲TRI** or **▲LTOF**):

- **▲TRI**:

In addition to edge-controlled **teach-in of the switching outputs** (slope control), the ODS... 96B with analog output can also be used to perform a time-controlled **teach-in of switching output and characteristic output curve** (time control) via the teach line. Both teach events are described in chapter 7.4.2.

- **▲LTOF**:

For the ODS... 96B with time-of-flight measurement principle, there is only a time-controlled teach model. The time intervals for the individual teach functions are, however, considerably different to those of the triangulation sensors. This teach event is described in chapter 7.4.3.

5.5 ODS... 96B/ODK... 96B M/L with IO-Link interface

The sensors are equipped with an IO-Link interface for measurement data output. The sensor cyclically transfers a data packet of 2 bytes at a baud rate of 38.4 k (COM2, Frame 2.2, Vers. 1.0) to the IO-Link master module. The sensor has no switching output; the SIO mode is not supported.

The process data and parameters are described in the IODD (IO-Link Device Description). You can download the IODD on the Internet from www.leuze.com.

The ODS... 96B/ODK... 96B M/L can be configured on the PC with a generic IODD interpreter. To do this, the PC is connected to the PC via an IO-Link master.

5.5.1 IO-Link process and service data

IO-Link process data

Output data device

Data bit															
A15	A14	A13	A12	A11	A10	A9	A8	A7	A6	A5	A4	A3	A2	A1	A0
MSB	16 bit measurement value														LSB

16 bit measurement value: distance

1 bit output resolution: 1 mm

Signal too weak: 65535

Signal error: 65534

Laser error: 65533

IO-Link service data

Sensors with IO-Link interface can be configured and diagnosed via the service data.

Measure mode parameter

With this parameter, a measure mode can be activated for adapting to the application task. There are four measurement modes (**Standard**, **Precision**, **Speed** and **Light Suppression**) to choose from.

Measure filter parameter

With this parameter, a measurement value filter can be activated for adapting to the application task. Three options are available (**Off**, **Averaging** and **Center Value**).



Notice

Detailed information on the parameters can be found in chapter 7.

5.5.2 IO-Link system commands and diagnostics (observation)

System commands

Laser transmitter activation

This system command switches on the laser transmitter.

Laser transmitter deactivation

This system command switches off the laser transmitter.

If the sensor is deactivated, then the most recently determined measurement value is frozen. The state of the laser can be monitored in the sensor state.

Setting to factory setting

This system command restores the factory settings of the sensor.

Diagnostics (observation)

Signal too weak [process value 65535], signal error [process value 65534] or laser error [process value 65533]

Reception signal is not sufficient: either no object is in the measurement range or the signal from the object is too low for measurement. A permanently displayed signal error indicates that the sensor has a defect. A displayed laser error indicates a laser-light source malfunction.

Signal warning

Low reception signal: the object is not detected reliably, e.g. because the signal from the object is very weak.

Laser activation

Status information on whether the laser transmitter is activated or deactivated.

Measurement range sensor

Status information on whether an object is located in the measurement range of the sensor.



Notice

If parameters are changed on the device via the display and keyboard, it is not signaled to the master. When there is an explicit query by the master, however, the changed value is available.



Notice

Detailed information about the IO-Link service data and the IODD can be found at www.leuze.com.

5.6 ODS... 96B/ODK... 96B M/D with serial interface

The sensors are equipped with one switching output and one serial interface, which is implemented either as an RS 232 interface or as an RS 485 interface. The transmission rate can be set to between 9,600 and 57,600 baud.

Serial transmission is performed with **1 start bit, 8 data bits and 1 stop bit without parity**. For the transmission of the measurement values, 4 different transmission modes may be configured (see figure 4.5):

- **ASCII measurement value**
(6 bytes)
- **14-bit measurement value**
(2 bytes, ODS 96 compatible)
- **16-bit measurement value**
(3 bytes, ODSL 30 compatible)
- **Remote control operation**

5.6.1 Measurement value output for various transmission types

Object distance	Measurement value output
No evaluable receive signal	65535 (signal too weak)
< Measurement range	Distance value (undefined linearity)
Within measurement range	Distance value linear
> Measurement range	Distance value (undefined linearity)
Device error	65334 (signal error) 65333 (laser error)

Measurement value ASCII transmission

Transmission format: **MMMMM<CR>**

- MMMMM** = 5-digit measurement value in mm (for 1 mm output resolution)
 or = 5-digit measurement value in 0.01 mm (for 0.1 mm output resolution)
<CR> = ASCII character "Carriage Return" (x0D)

Measurement value = 14 bit

output resolution 0.1mm/1 mm (type dependent)

1. Low Byte (bit 0 = 0)



bit 6
bit 5
bit 4
bit 3
bit 2
bit 1
bit 0 (LSB)

2. High Byte (bit 0 = 1)



bit 13 (MSB)
bit 12
bit 11
bit 10
bit 9
bit 8
bit 7

Measurement value = 16 bit

output resolution 0.1mm/1 mm (type dependent)

1. Low Byte (bit 0 = 0, bit 1 = 0)



bit 5
bit 4
bit 3
bit 2
bit 1
bit 0 (LSB)

2. Middle Byte (bit 0 = 1, bit 1 = 0)



bit 11
bit 10
bit 9
bit 8
bit 7
bit 6

3. High Byte (bit 0 = 0, bit 1 = 1)



don't care
don't care
bit 15 (MSB)
bit 14
bit 13
bit 12

Remote control operation

ASCII transfer of the measurement value on request

4 digits (4 bytes) **or 5 digits** (5 bytes).

Bild 5.11: ODS... 96B/ODK...96B M/D serial transmission formats

5.6.2 Commands for remote control operation

For remote-control operation (Serial -> Com Function -> Remote control), a device address can be set between 0 and 14 (Serial -> Node Address).

In this operating mode, the ODS 96B M/D only responds to commands from the control. The following control commands are available:

Measurement value query, 4 digits:

	Byte no.									Response time	
	0	1	2	3	4	5	6	7	8		
Command	Sensor address 0x00 through 0x0E	-	-	-	-	-	-	-	-	-	
Sensor response	"*" (0x2A)	ASCII address tens	ones	ASCII distance measurement value 1'000's 100's tens ones				"#" (0x23)	-	max. 15ms	

Measurement value query, 5 digits:

	Byte no.									Response time	
	0	1	2	3	4	5	6	7	8		
Command	"*" (0x2A)	ASCII address "0...9", "A...D"	"M" (0x4D)	"#" (0x23)	-	-	-	-	-	-	
Sensor response	"*" (0x2A)	ASCII address "0...9", "A...D"	ASCII distance measurement value 10'000's 1'000's 100's tens ones				State	"#" (0x23)	max. 15ms		

Execute the referencing function (only for ):

	Byte no.									Response time	
	0	1	2	3	4	5	6	7	8		
Command	"*" (0x2A)	ASCII address "0...9", "A...D"	"R" (0x52)	"#" (0x23)	-	-	-	-	-	-	
Sensor response	"*" (0x2A)	ASCII address "0...9", "A...D"	State	"#" (0x23)	-	-	-	-	-	-	max. 2s

Detailed information on referencing can be found in chapter 7.8.2

Execute preset measurement:

	Byte no.									Response time	
	0	1	2	3	4	5	6	7	8		
Command	"*" (0x2A)	ASCII address "0...9", "A...D"	"P" (0x52)	"#" (0x23)	-	-	-	-	-	-	
Sensor response	"*" (0x2A)	ASCII address "0...9", "A...D"	State	"#" (0x23)	-	-	-	-	-	-	max. 2s

Detailed information on Preset/Offset can be found in chapter 7.8.1

Activate sensor:

	Byte no.									Response time
	0	1	2	3	4	5	6	7	8	
Command	"*" (0x2A)	ASCII address "0...9", "A...D"	"A" (0x41)	"#" (0x23)	-	-	-	-	-	
Sensor response	"*" (0x2A)	ASCII address "0...9", "A...D"	State	"#" (0x23)	-	-	-	-	-	max. 15ms

Deactivate sensor:

	Byte no.									Response time
	0	1	2	3	4	5	6	7	8	
Command	"*" (0x2A)	ASCII address "0...9", "A...D"	"D" (0x44)	"#" (0x23)	-	-	-	-	-	
Sensor response	"*" (0x2A)	ASCII address "0...9", "A...D"	State	"#" (0x23)	-	-	-	-	-	max. 15ms

Status byte (bitwise processing):

Bit number	Meaning
7 (MSB)	always = 0 (reserved)
6	1 = other error (e.g. no measurement possible or referencing / preset not successful), 0 = OK
5	always = 1
4	always = 0 (reserved)
3	always = 0 (reserved)
2	1 = sensor deactivated, 0 = sensor activated
1	1 = no signal or signal too low, 0 = signal OK
0 (LSB)	1 = laser interference, 0 = laser OK

5.6.3 Termination of the data lines of the OD... 96B/D3...

The OD... 96B/D3... features a combined transmitter and receiver component that can transmit serial data according to the RS 485 and RS 422 standard (see TIA/EIA-485-A or DIN66259, Part 3).

These standards define some basic rules that should be followed in order to achieve the most reliable data transmission:

- The data lines A and B (which correspond to the OD... 96B pins Tx+ and Tx-) are connected to an intrinsic impedance of $Z_0 \approx 120\Omega$ via a 2-wire twisted pair cable.
- The end of the data line (and the beginning in case of RS 485) is terminated using a 120Ω resistor. The OD... 96B/D3... does not have an internal bus termination.
- The RS 485 bus participants are wired in an in-line bus topology, i.e., the data line is fed from one bus participant to the next. Cable stubs are to be avoided or to be kept as short as possible.
- The RS 485 specification assumes an inactive potential difference of $U_{AB} \geq 200\text{mV}$ between the data lines. A bus termination in the form of a voltage divider should be implemented in order to maintain this level. Usually, it is connected to the RS 485 coupling module of the PLC.

The RS 485 specification permits transmission rates in the megabit range for up to 32 participants. The OD... 96B/D3... is designed for a data transmission rate of typically 9600 baud (9600 ... 57600 baud may be configured). In practice, this means that the strict requirements regarding the bus termination and the cabling are "softened" for a few bus participants.

However, it is important to maintain the bus idle levels ($U_{AB} \geq 200\text{mV}$). If the PLC coupling module does not include a bus termination with voltage divider, the following circuit may be used.

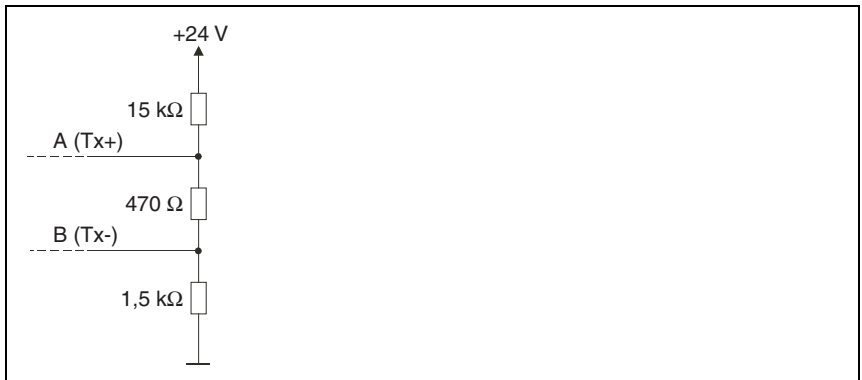


Bild 5.12: Voltage divider for the RS 485 bus termination

The RS 422 connection does not require a bus termination for cable lengths up to about 20m and data transmission rates less than 9600 Baud.

Further information:

- RS 422: Electrical Specification acc. to DIN 66259, Part 3
- ISO 8482: Abstract

Specifies the physical medium characteristics for twisted pair multipoint interconnections in either 2-wire or 4-wire network topology, a binary and bi-directional signal transfer, the electrical and mechanical design of the endpoint system branch cables and the common trunk cable which may be up to 1200m in length, the component measurements of the integrated type generators and receivers within the endpoint system, the applicable data signaling rate up to 12.5Mbit/s.

5.6.4 Operation on the fieldbus and the Ethernet

OD... 96B/D2... sensors with an RS 232 serial interface can be connected with MA 2xxi modular interfacing units to the following fieldbus and Ethernet types:

- PROFIBUS DP → **MA 204i**
- Ethernet TCP/IP → **MA 208i**
- CANopen → **MA 235i**
- EtherCAT → **MA 238i**
- PROFINET-IO → **MA 248i**
- DeviceNet → **MA 255i**
- EtherNet/IP → **MA 258i**

To do this, the modular interfacing unit is connected to the sensor via a connection cable. To operate the distance sensors, rotary switch **S4** of the modular interfacing unit must be set to switch position **B**.

Further details can be found in the technical descriptions of the modular interfacing units.



Notice

The default settings of the ODS serial interface have to be adjusted. Further information on configuration of the interface can be found in the technical description of the corresponding device.

Specifications for the serial interface

COM function: ASCII

Baud rate: 38400 baud

The OD... 96B/D2... is to be operated in the "Precision" measure mode. The mode is set through the display menu via **Application** -> **Measure mode** -> **Precision** (see chapter 7.2.6).

5.7 ODS... 96B/ODK...96B M/66 with two switching outputs

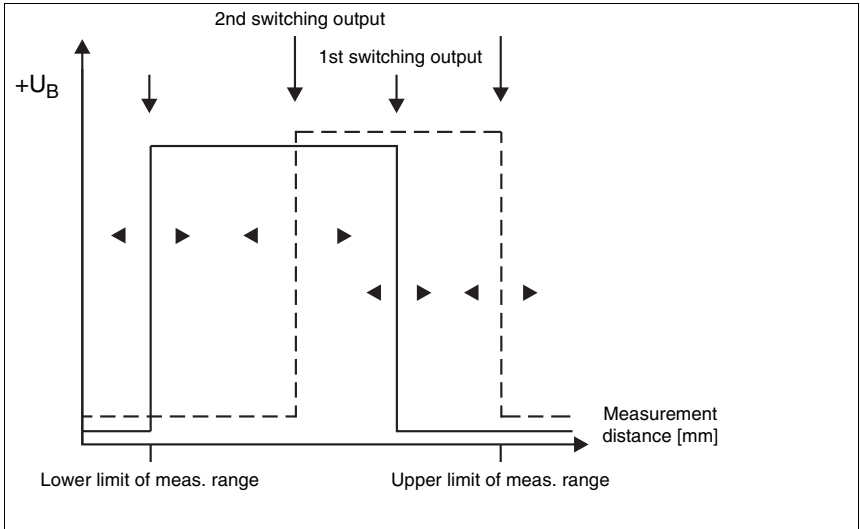


Bild 5.13: Behavior of the switching outputs ODS... 96B/ODK... 96B M/66

The two switching outputs of the ODS... 96B/ODK... 96B M/66 operate independently of each other. Upper and lower switching points as well as hysteresis can be set separately for both switching outputs via the OLED display or the configuration software.

Via the teach input, either the upper or the lower measurement range limit can be taught for both switching outputs or, alternatively, the center of the switching range. A common teach line is available for both switching outputs. An exact description of the teach event can be found in chapter 7.3.

6 Installation

6.1 Storage and transport



Attention!

When transporting or storing, package the sensor so that it is protected against collision and humidity. Optimum protection is achieved when using the original packaging. Heed the required environmental conditions specified in the technical data.

Unpacking

- ↳ Check the packaging for any damage. If damage is found, notify the post office or shipping agent as well as the supplier.
- ↳ Check the delivery contents using your order and the delivery papers:
 - Delivered quantity
 - Device variant and model as indicated on the nameplate
 - Laser warning signs
 - Technical description

The name plate provides information as to what type of distance sensor your device is.

- ↳ Save the original packaging for later storage or shipping.


If you have any questions concerning your shipment, please contact your supplier or your local Leuze electronic sales office.

- ↳ Observe the applicable local regulations when disposing of the packaging materials.

6.2 Mounting

Mounting systems are available which have to be ordered separately at Leuze electronic. The order number can be found in chapter 11.3 and chapter 11.4. Apart from this, the drilled-through holes are suitable for the individual mounting of the ODS, depending on the area in which it is to be used.

Installation

To avoid errors while the object enters the measurement beam, correct entry direction of the objects has to be observed for sensors with triangulation principle ( **TRI**). The following graphics show instructions on the installation:

Preferred direction of entry of the objects when using triangulation sensors

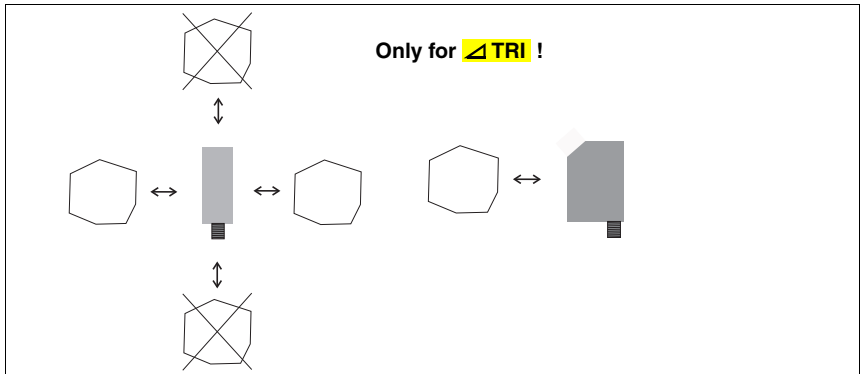


Bild 6.1: Preferred direction of entry of the objects when using triangulation sensors

Preferred mounting of triangulation sensors for structured surfaces

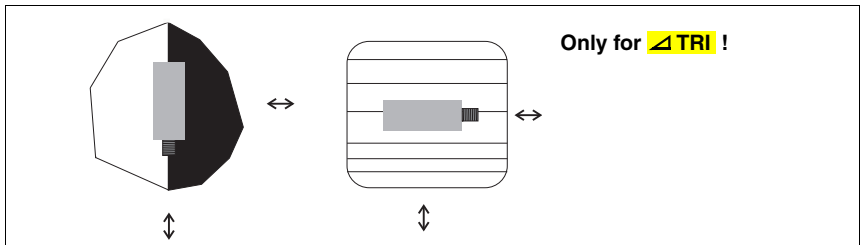


Bild 6.2: Preferred mounting of triangulation sensors for structured surfaces

View through a chase

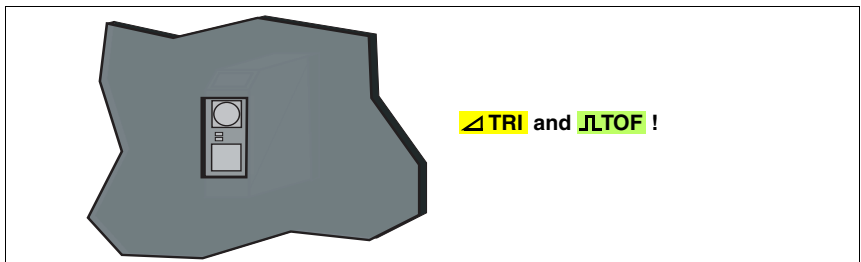


Bild 6.3: View through a chase

If the distance sensors have to be installed behind a cover, the chase has to have at least the size of the optical glass cover. Otherwise, a correct measurement is not possible or can not be guaranteed.

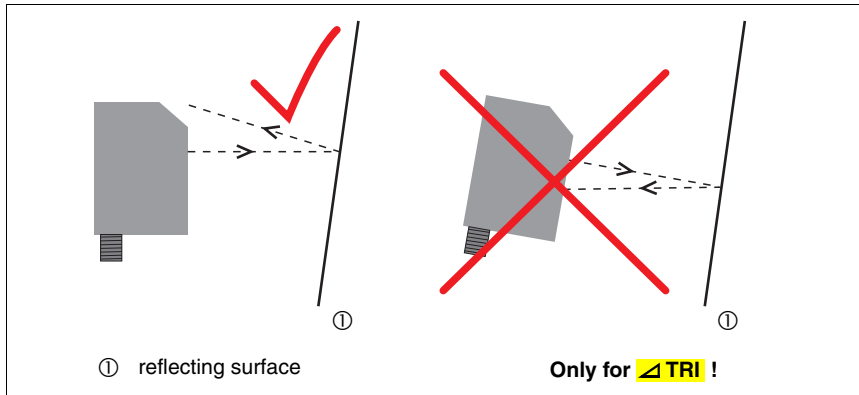
Alignment to measurement objects with reflecting surfaces

Bild 6.4: Alignment to measurement objects with reflecting surfaces

If the measurement object to be detected has a reflecting surface, a measurement may not be possible depending on the angle in which the light is reflected by the measurement object's surface. The directly reflected part of the transmitted light beam must not be incident on the receiver of the distance sensor. Adjust the angle between the sensor and the measurement object such that the sensor can reliably detect the measurement object.

7 Operation

7.1 Indicator and operating elements

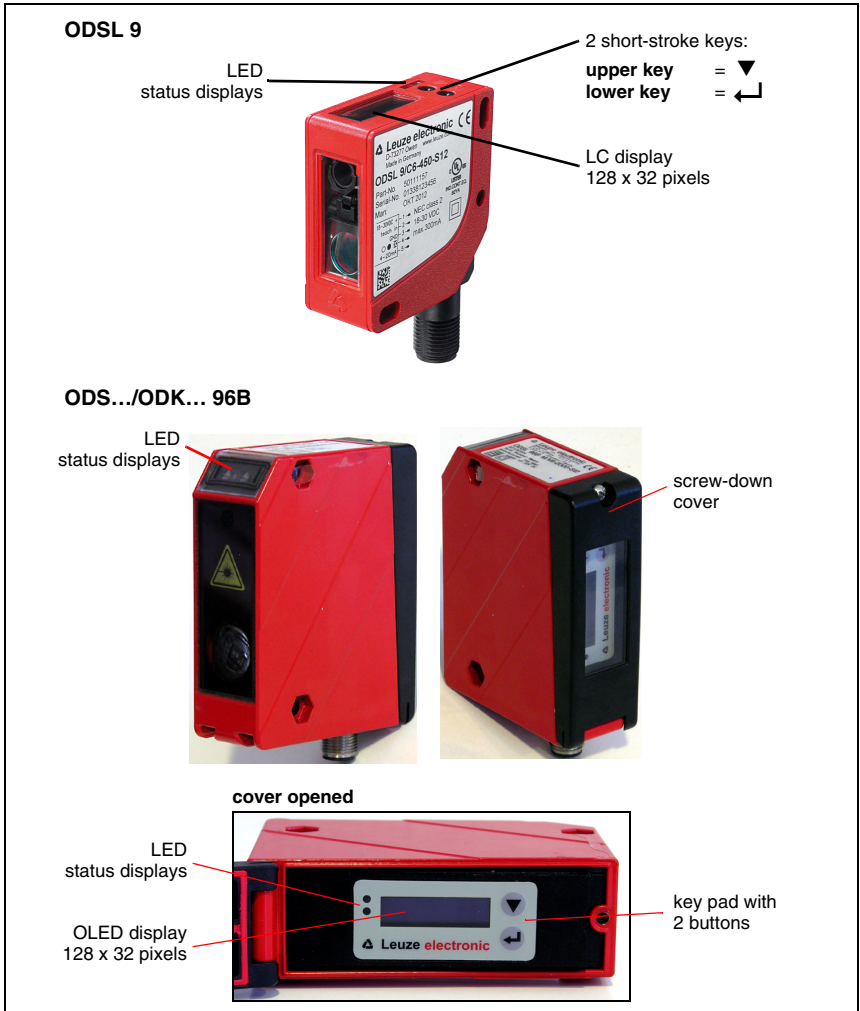


Bild 7.1: Indicator and operating elements

The device LEDs display the operating state. For the ODS... 96B/ODK... 96B, the device LEDs have an identical function on the front and back of the distance sensor. During measurement operation, the dot matrix display shows the distance measurement value.

7.1.1 LED status displays

LED	State	Display during sensor operation
green	continuous light	ready
	flashing	interference
	off	no supply voltage
yellow	continuous light	object inside teach-in measurement range
	off	object outside teach-in measurement range

Tabelle 7.1: LED function indicator

During teach-in, the LED indicator deviates from the information shown in Table 7.1 and varies depending on the selected teach mode. Detailed information on this topic can be found in chapter 7.3.

7.1.2 Control buttons

The LC display and control buttons of the ODSL 9 are always accessible. The OLED display and key pad of the ODS... 96B/ODK... 96B are protected by a screw-down cover.



Notice

For the ODS... 96B/ODK... 96B, safety class II at a rated voltage of 250VAC is only ensured with the cover closed.

The ODS is operated using the ▼ and ← buttons, which are located next to the display.



Notice

The ▼ button on sensors of the ODSIL design (TOF sensors with infrared laser) serves to switch on/off the red alignment laser.



Notice

The control buttons of the ODSL 9 are not labeled:

- The **upper key** corresponds to the ▼ button of the ODS... 96B/ODK... 96B.
- The **lower key** corresponds to the ← button of the ODS... 96B/ODK... 96B.

7.1.3 Displays

The display changes depending on the current operating mode. There are the following two display modes:

- Measure mode
- Menu display

The menu display is accessed by pressing one of the two control buttons. Operation via the menu is described in chapter 7.2.

After switching on the supply voltage +U_B and following error-free initialization of the device, the green LED illuminates continuously, the distance sensor is in measure mode.

In measure mode, the current measurement value is displayed in the display, e.g. 255mm.



Notice

After a warmup time of 20 min., the device has reached the operating temperature required for an optimum measurement.

Status displays in measure mode

In case of a weak reception signal, "Low" appears in the display.



If no object is detected or if the signal is too weak, "No Signal" appears in the display.



If the current measurement value of sensors with analog output exceeds the range for the analog output, an arrow appears on the right next to the measurement value.

An arrow pointing downward indicates that the current measurement value is lower than the lower limit of the analog output.



An arrow pointing upward indicates that the current measurement value is larger than the upper limit of the analog output.



If the laser has been deactivated, then "□X" appears in the display



If a distance calibration has been performed, then "+O" or "+R" appear in the display.

The "+O" display appears if an offset or preset was activated.



The "+R" display appears if the referencing function has been activated.



Errors at the Q1/Q2 switching outputs are indicated as follows.

Lightning bolt icon with an underlying point:

short-circuit at switching output Q1 or configuration adapter UPG10 connected, but PC not connected.



Lightning bolt icon with underlying bar:

short-circuit at switching output Q2.



A wrench icon with the text "Signal Error" indicates a signal error. A permanently displayed signal error indicates that the sensor has a defect.




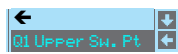
7.1.4 Operation/navigation

In menu display, the display has two lines. The ▼ and ↵ buttons both have different functions depending on the operating situation. These functions are represented via icons on the right edge of the display – i.e. to the immediate left of the buttons.

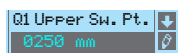
The following situations can occur:

Menu navigation


 ▼ selects the next menu item (Output Q1)
 ↵ switches to the submenu shown with inverted colors (Input)


 ▼ selects the next menu item (Q1 Upper Sw. Pt.)
 ↵ returns to the next higher menu (←). At the top menu level, the menu can be exited here (← Menu Exit). The number of bars at the left edge indicates the current menu level:


Selecting values or selection parameters for editing


 ▼ selects the next menu item (↓ -> Q1 Lower Sw. Pt.)
 ↵ selects edit mode for Q1 Upper Sw. Pt

Editing value parameters

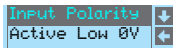
 ▼ changes the value of the first digit (1)
 ↵ selects the second digit (0) for editing

 ▼ changes the edit mode; ⌚ appears
 ↵ saves the new value (0010)

 ▼ changes the edit mode, ☒ appears
 ↵ selects the first digit (0) for renewed editing. If an impermissible value was entered, the "new entry" icon initially appears and the checkmark is not available for selection.

 ▼ changes the edit mode, ⌚ or ☑ appears
 ↵ rejects the new value (1016 remains saved)

Editing selection parameters



▼ displays the next option for input polarity (Active High +24V)
 ← returns to the input menu and retains Active Low 0V



▼ shows the next option for input polarity (Active Low 0V)
 ← selects the new value Active High +24V and displays the confirmation menu:



▼ changes the edit mode; ☒ ← saves the new value (Active High +24V)

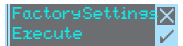


▼ changes the edit mode; ☑
 ← rejects the new value (Active Low 0V remains saved)

7.1.5 Reset to factory settings

Press the ← button while switching on the device to reset the configuration of the ODS.../ODK... to the state upon delivery from the factory.

Press the ← button again to reset all parameters to the factory settings. All settings made previously are permanently lost. Press ▼, and the ODS.../ODK... returns to measurement operation without resetting the parameters.



You can also use the menu or the configuration software to reset to factory settings (see chapter 7.2.7).

7.2 Configuration / menu structure

7.2.1 Input

The Input menu only appears if your sensor has a binary input. The function of the input at pin 2 is set in the Input menu.

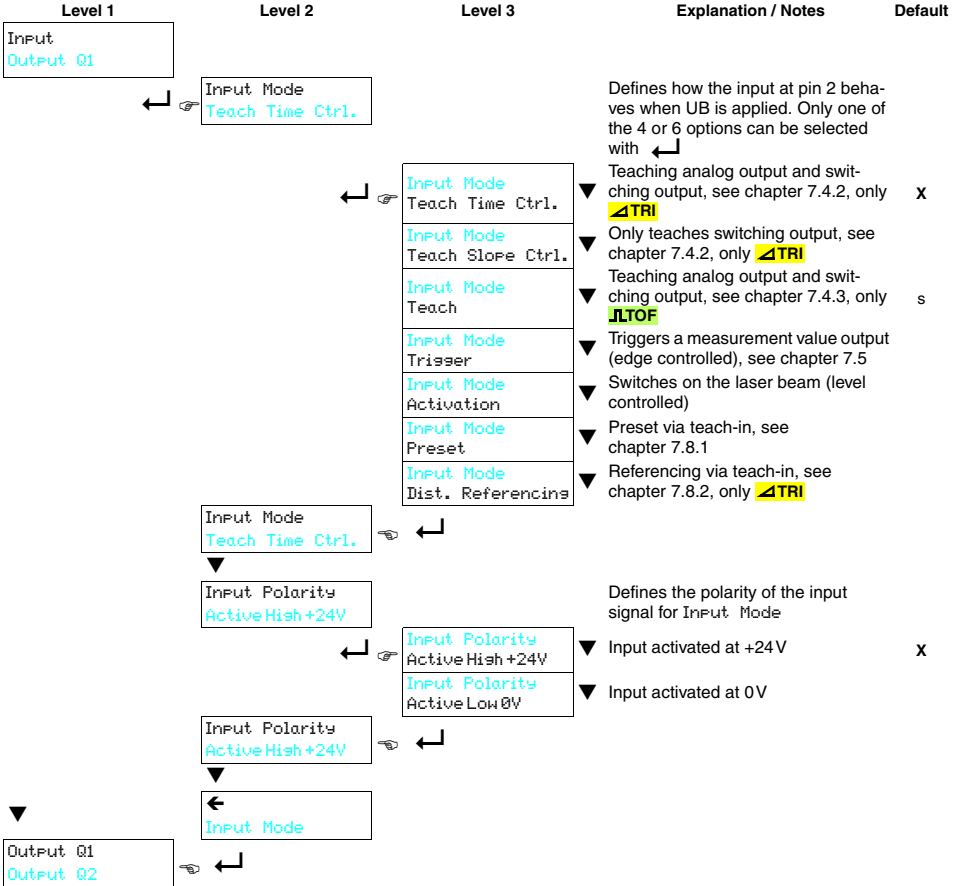


Tabelle 7.2: Input menu

7.2.2 Output Q1

The Output Q1 menu only appears if your sensor has a binary output Q1. It is used to set the switching behavior of switching output Q1.

Level 1	Level 2	Level 3	Explanation / Notes	Default
Output Q1 Analog Output	Q1 Upper Sw. Point 0600 mm	↕+↕ for changing the values	Adjusts the switching behavior of output Q1 Upper switching point	Upper limit of meas. range/2 ¹⁾
	Q1 Lower Sw. Point 0200 mm	↕+↕ for changing the values	Lower switching point	Lower limit of meas. range ¹⁾
	Q1 hysteresis 0050 mm	↕+↕ for changing the values	Hysteresis	10x minimum sensor resolution ¹⁾
	Q1 Light/Dark Dark Switching		Dark switching	
	Q1 Light/Dark Dark Switching	Q1 Light/Dark Dark Switching	Light switching	X
	Q1 Light/Dark Dark Switching	Q1 Light/Dark Light Switching		

Tabelle 7.3: Menu Output Q1

1) You can determine the values for your sensor using the type key on page 21 and the appropriate data in chapter 10.1. For ODSL 96B sensors with time-of-flight measurement principle, the assured measurement range 300 ... 6,000mm applies (6 ... 90% diffuse reflection).

The adjustable parameters have the following meaning:

- **Light switching:** If an object is located between the upper and lower switching point, the switching output is **active (high)**.
- **Dark switching:** If an object is located between the upper and lower switching point, the switching output is **not active (low)**.
- **Hysteresis:** Expansion of the switching range for switching off. For switching on, the set switching points remain always valid.

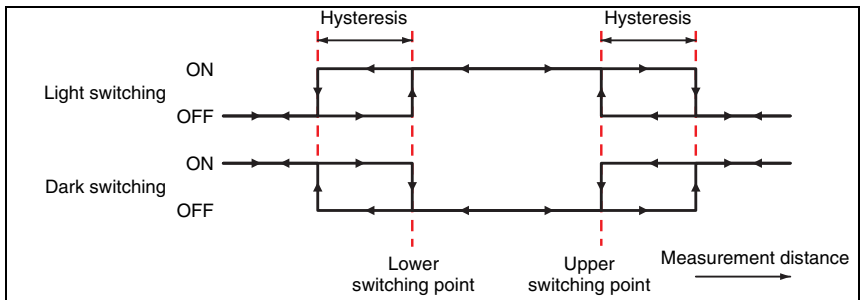


Bild 7.2: Behavior of the switching outputs

7.2.3 Output Q2

The Output Q2 menu only appears if your sensor has a binary output Q2. It is used to set the switching behavior of switching output Q2. The adjustable parameters correspond to those of output Q1.

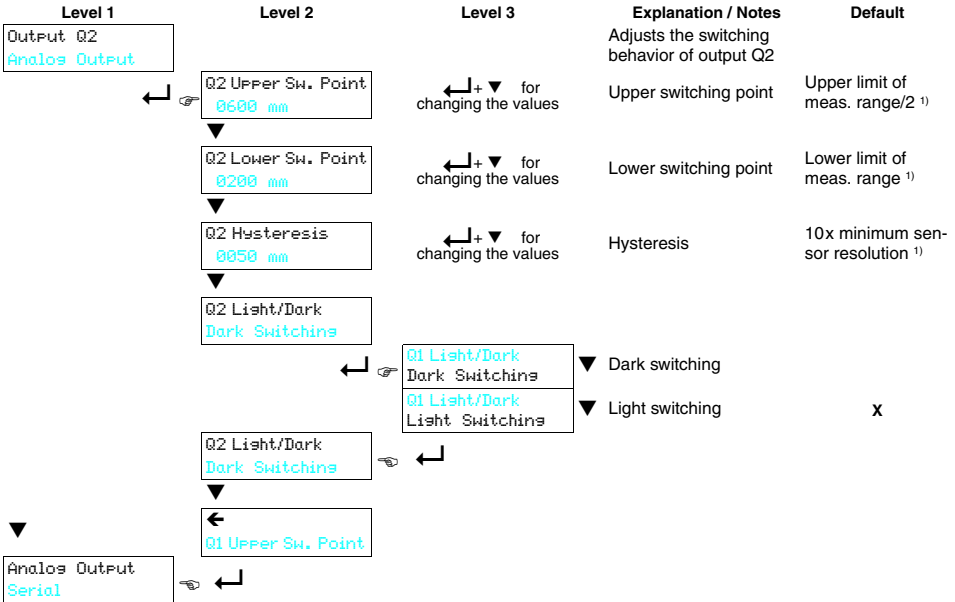


Table 7.4: Menu Output Q2

1) You can determine the values for your sensor using the type key on page 21 and the appropriate data in chapter 10.1. For ODSL 96B sensors with time-of-flight measurement principle, the assured measurement range 300 ... 6,000mm applies (6 ... 90% diffuse reflection).

7.2.4 Analog Output

The Analog Output - menu only appears if your sensor has an analog output. It is used to adjust the characteristic output curve of the analog output.

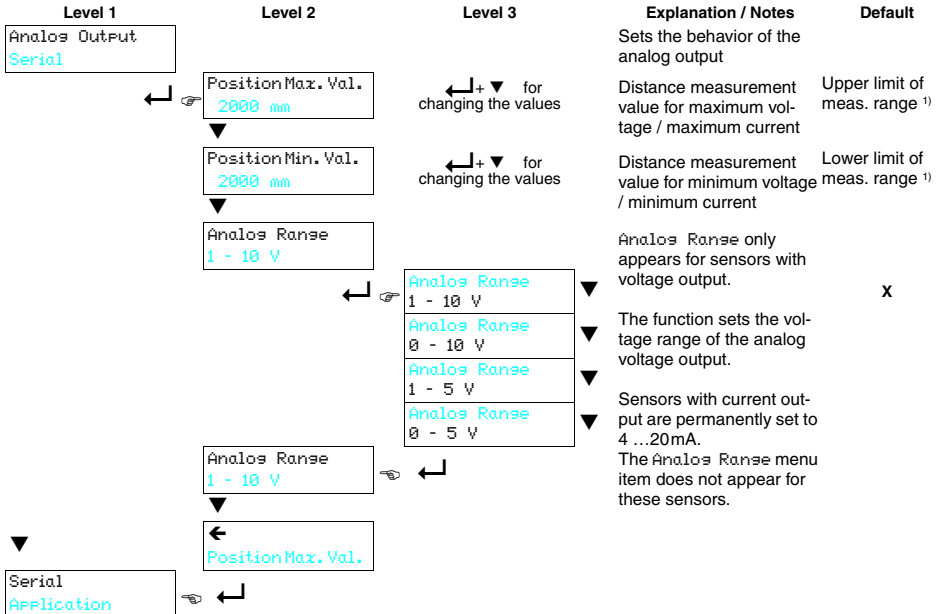


Tabelle 7.5: Analog Output menu

1) You can determine the values for your sensor using the type key on page 21 and the appropriate data in chapter 10.1. For ODSL 96B sensors with time-of-flight measurement principle, the assured measurement range 300 ... 6,000mm applies (6 ... 90% diffuse reflection).

For sensors with voltage output, select the voltage range of the analog output. Then set the distance which corresponds to the lower range limit (0V, 1V or 4 mA) at the analog output and the distance which corresponds to the upper range limit (5V or 10V or 20 mA). This lets you spread the characteristic output curve according to your requirements.

It is also possible to invert the working range of the analog output, i.e., the selected value of the lower range limit is larger than that of the upper range limit. This creates a descending characteristic output curve.



Notice

The adjustable working ranges are dependent on the selected device type and must lie within the sensor's measurement range. The check to determine whether the entered values are plausible and valid is performed after the upper and lower limits are entered. Invalid values cannot be saved. You can either change the entered value (↶) or cancel the entry without saving (⊗).

7.2.5 Serial

The Serial - menu only appears if your sensor has a serial interface. It is used to adjust the serial interface parameters.

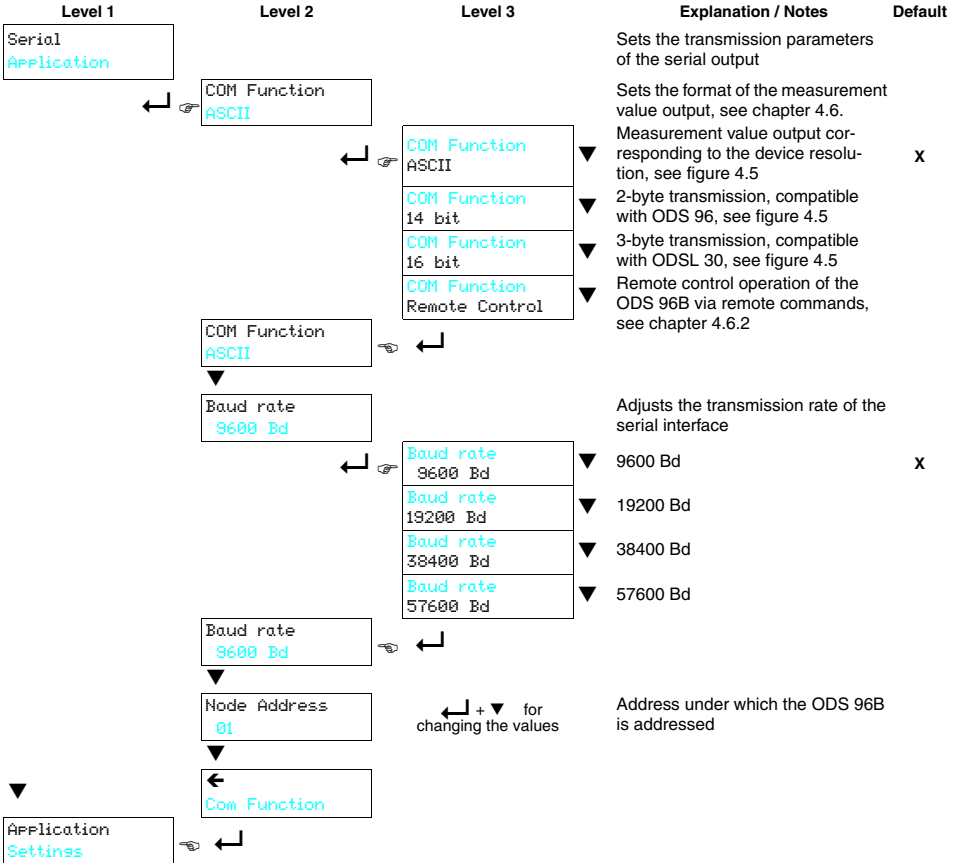


Tabelle 7.6: Serial menu

7.2.6 Application

In the Application menu, the measurement function of the sensor can be optimized for the given application. Several measure modes, measurement filters and a distance calibration are available for this purpose. Details on the function can be found in chapter 7.6 to chapter 7.8.

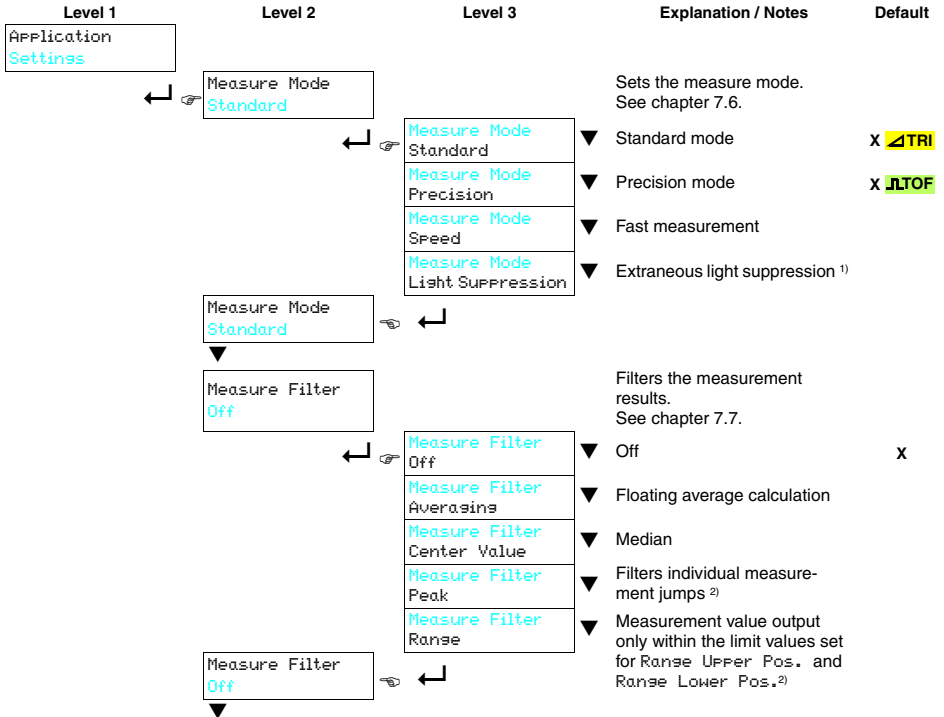


Tabelle 7.7: Application menu

Level 1	Level 2	Level 3	Explanation / Notes	Default
	Measurement. Count 10		Sets the number of measurement values which are read in for the Average and Center Value filters. For Center Value: selection in steps of 10:	
		Measurement. Count 10 Measurement. Count 20 Measurement. Count 30 Measurement. Count 40 Measurement. Count 50	▼ 10 measurement values ▼ 20 measurement values ▼ 30 measurement values ▼ 40 measurement values ▼ 50 measurement values	X
		Measurement. Count 07	For Averaging: Set from 1 ... 99 ←+ ▼ for changing the values	01
	Measurement. Count 10 Filter Depth Coarse			
		Filter Depth Coarse Filter Depth Medium Filter Depth Fine	▼ Sets the filter depth for the Center Value measurement filter. Prevents falsification of the average value by "outliers". A small number of extreme values are not taken into account. ▼ Some extreme values are not taken into account. ▼ A large number of extreme values are not taken into account.	X
	Filter Depth Coarse Peak Window Medium			
		Peak Window Medium Peak Window Fine	▼ For the Peak measurement filter, sets the minimum deviation of the measurement values from the previous measurement value ²⁾ ▼ Medium change in measurement value ▼ Small change in measurement value	X
	Peak Window Medium Range Upper Pos. 2000 mm			
			Upper limit for the Range measurement filter ²⁾	Upper limit of meas. range

Tabelle 7.7: Application menu

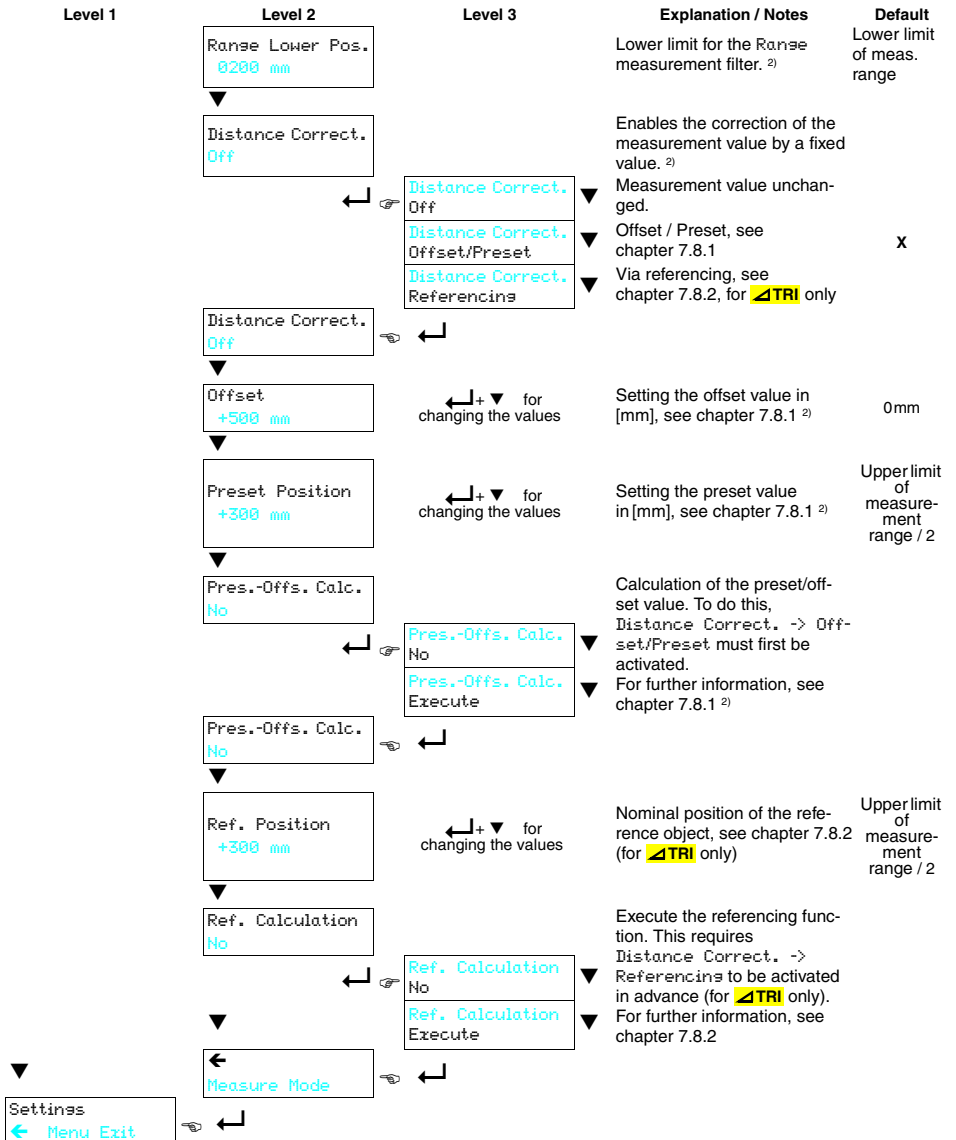


Tabelle 7.7: Application menu

- 1) Only for ODSL 96B M/C6.C1S-1500-S12 5012 and ODSL 96B M/V6.C1S-1500-S12 (**▲TRI**).
- 2) Sensors with an IO-Link interface do not have this menu item available.

7.2.7 Settings

In the Settings - menu, information on the ODS can be called up and set in the display.

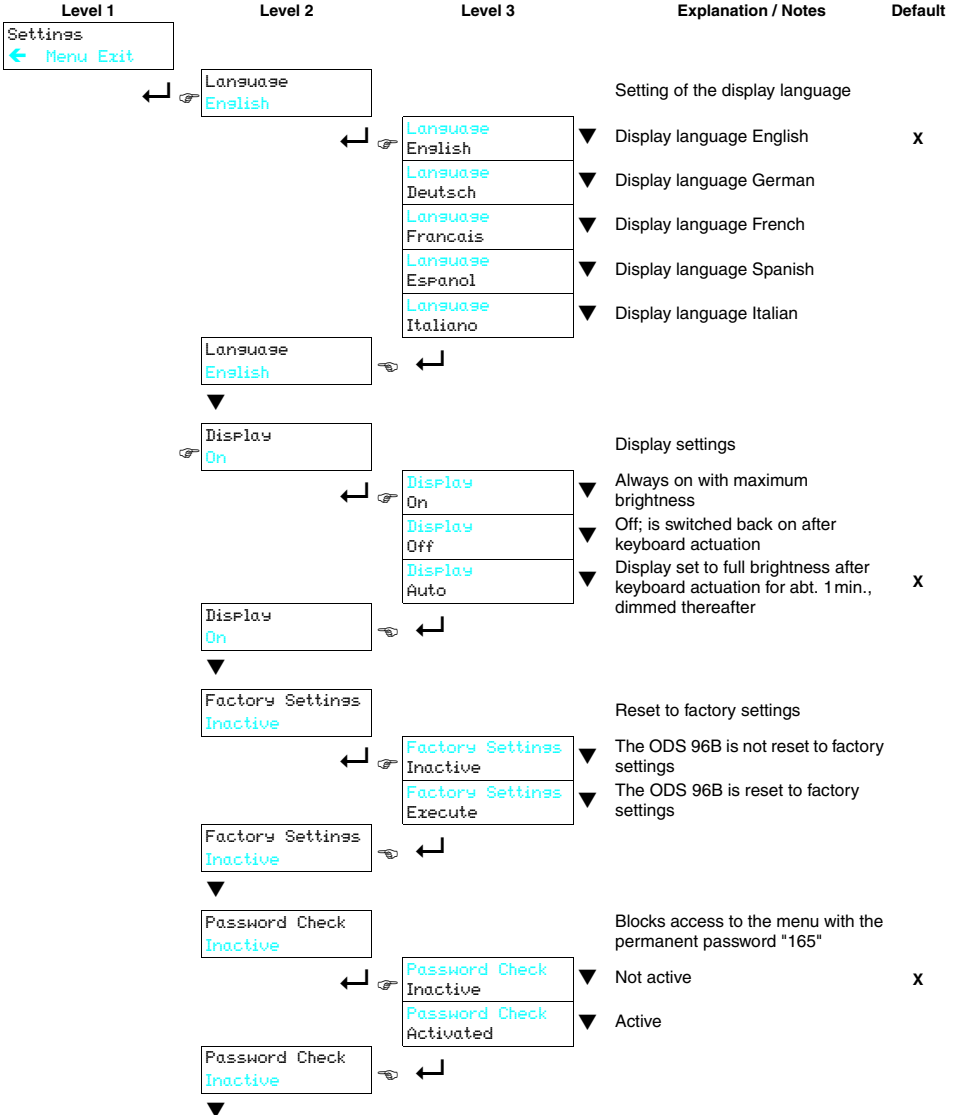


Tabelle 7.8: Settings menu

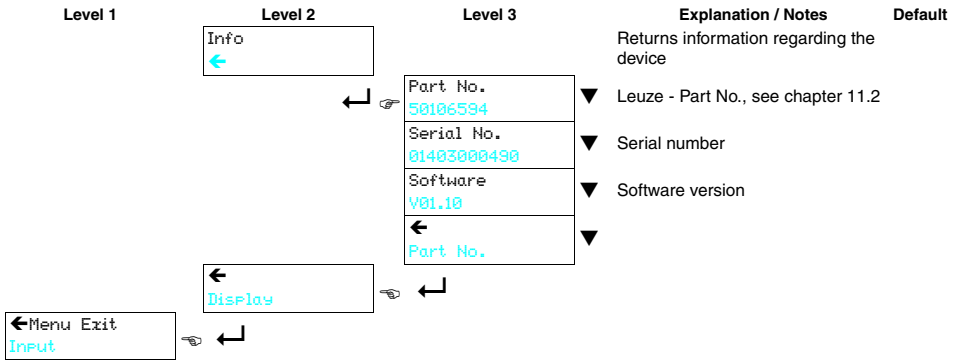
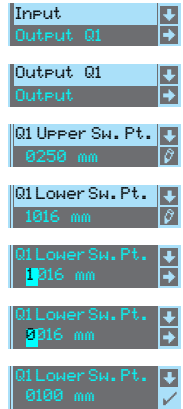


Table 7.8: Settings menu

7.3 Configuration example - lower switching point

To illustrate menu operation, we will explain how to set the lower switching point of switching output Q1 to 100mm as an example

- ↳ In the measure mode, press a button (once or twice) until the menu appears.
- ↳ Press ▼; Output Q1 appears in the top menu line.
- ↳ Press ← to select Output Q1.
- ↳ Press ▼ again; Q1 Lower Sw. Pt. appears in the upper menu line.
- ↳ Press ← to set the lower switching point. The first digit of the switching point value is displayed with inverted colors.
- ↳ Press ▼ as many times as necessary to set the desired value 0.
- ↳ Accept the value by pressing ←; repeat the procedure for all other digits.



After pressing ← for the 4th time, a ☑ appears in the lower right part of the display. The ☑ indicates that the next time ← is pressed, the set value will be accepted. This behavior of the ← button can be changed by repeatedly pressing ▼. A ↻ (re-edit value) and a ☒ (eject value) then appear in succession.

- ↳ Once you have completed the setting, accept the value by pressing ←; now, Q1 Lower Sw. Pt. is again displayed with inverted colors, and the new value, saved in non-volatile memory, is displayed.
- ↳ Repeatedly press ▼ until ← appears in the upper menu line.
- ↳ Press ← to access the next-higher menu level.
- ↳ Repeatedly press ▼ until ← Menu Exit appears in the upper menu line.
- ↳ Press ← to exit the menu and return to normal measurement operation.



Notice

The selectable or editable values are shown with inverted text colors (black on light-blue background).

If no button is pressed in the configuration menu within 120s, the brightness is then reduced. If no button is pressed in the 60 s after that, the device automatically returns to measure mode.

The device can be protected against unintentional changes to the configuration by activating the password function (see table 7.8 on page 72). The **password** is always set to "165".

7.4 Teach-in

Switching points and characteristic output curves can also be set through teach-in without using the software. The following instructions require that you have familiarized yourself with the operation of the ODS using the control buttons and the display.

7.4.1 Setting the teach point

The settings made via the menu or software for the two values **Q1 Upper Sw. Point** and **Q1 Lower Sw. Point** determine the point which is to be taught (applies in an analogous way for Q2). In the following examples, we will consider an ODS 96B with 100 ... 600mm measurement range.

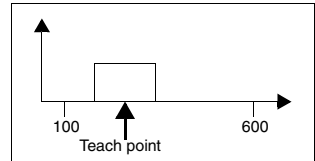
Q1 Lower Sw. Point > 100mm AND Q1 Upper Sw. Point < 600mm

If **both switching points** are set to a value \neq **Lower limit of measurement range** or **Upper limit of measurement range** using the menu or software, the difference between the two values defines a switching range. The teach point is the center of the switching range.

Example:

- Q1 Lower Sw. Point = 400mm
- Q1 Upper Sw. Point = 500mm
- yields a switching range of 100mm

The teach point lies in the middle of the switching range. If a distance of e.g. 300mm is now taught, the Q1 switches on at 250mm and back off at 350mm.



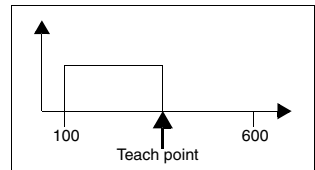
Q1 Lower Sw. Point = 100mm AND Q1 Upper Sw. Point < 600mm

If the **lower switching point** is set to the **Lower limit of measurement range** using the menu or software, the **upper switching point** is taught.

Example:

- Q1 Lower Sw. Point = 100mm
- Q1 Upper Sw. Point = 357mm

The teach point defines the upper switching point. If a distance of e.g. 300mm is now taught, the Q1 switches on at 100mm and back off at 300mm.



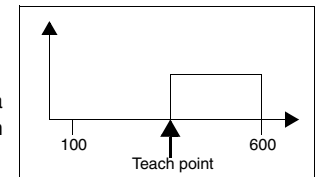
Q1 Lower Sw. Point > 100mm AND Q1 Upper Sw. Point = 600mm

If the **upper switching point** is set to the **Upper limit of measurement range** using the menu or software, the **lower switching point** is taught.

Example:

- Q1 Lower Sw. Point = 225mm
- Q1 Upper Sw. Point = 600mm

The teach point defines the lower switching point. If a distance of e.g. 300mm is now taught, the Q1 switches on at 300mm and back off at 600mm.



7.4.2 Teach-in for triangulation sensors

Teach-in of the switching outputs (slope control)

In this teach mode, the teach event is performed in the same way as with the ODS 96.

- ↳ On the OLED display, activate menu item:
Input -> Input Mode -> Teach slope control
- ↳ Position the measurement object at the desired distance.
- ↳ Activate the "**teach in**" input (pin 2) for at least 100 ms (by applying +U_B or GND, depending on the setting for Input Polarity, see chapter 7.2.1).

The yellow and green LEDs flash **simultaneously** during this process.

- ↳ After that, connect the teach input to GND.

You have now taught in the 1st switching output.

If your device has another switching output which you would like to teach:

- ↳ Position the measurement object at the second desired distance.
- ↳ Reactivate the "**teach in**" input (pin 2) for ≥ 2 s.

The yellow and green LEDs flash **alternately** during this process.

- ↳ After that, connect the teach input to GND.

You have now taught in the 2nd switching output.

The taught switching points are dependent on the settings for the upper and lower switching point, see "Setting the teach point" on page 75.

Teach-in of the switching outputs/characteristic output curve (time control)

In addition to the edge controlled teach-in of the switching output, it is also possible to perform a level-controlled teach-in of switching output and output characteristic curve via the teach line for ODS... 96B devices with analog output. The following steps are necessary for the level-controlled teach-in:

If you have changed the factory setting for teaching under Input Mode:

- ↳ On the OLED display, activate menu item:
Input -> Input Mode -> Teach time control
- ↳ Position the measurement object at the desired teach distance.



Notice

Please note that the teach distance must lie within the measurement range.

- ↳ Activate the "**teach in**" input (pin 2) (by applying +U_B or GND, depending on the setting for Input Polarity, see chapter 7.2.1).

The duration of the activation of the teach input determines the teach step according to the table shown below. The teach event is indicated by the flashing of the LEDs and on the display.

Teach function	Duration of teach signal	Green LED	Yellow LED
Switching output Q1 Teach point, see chapter 7.4.1	2 ... 4s	flash synchronously	
Distance value for start of measurement range = 1V / 4mA at analog output (pin 5)	4 ... 6s	continuous light	flashing
Distance value for end of measurement range = 10V / 20mA at analog output (pin 5)	6 ... 8s	flashing	continuous light

Table 7.9: LED indicator while teaching the characteristic output curve (time control)

At the end of the given teach event:

↪ Reconnect the teach input to GND.

The menu entries can be used to check that the teach values are properly accepted and to make any changes.

If the teach event is not successful, the following remedy is possible:

- Repeat teach event **or**
- Disconnect sensor from voltage to restore the old values.



Notice

If the measurement range start is taught to a distance greater than the measurement range end, a declining characteristic output curve is automatically set.

Second switching output for Time Control

Sensors with two switching outputs can also be taught in Time Control mode. The LEDs indicate the respective teach step as follows:

- green and yellow LEDs flash simultaneously: Teach switching output Q1
- green LED is on continuously, yellow LED flashes: Teach switching output Q2

7.4.3 Teach-in for time-of-flight sensors **ILTOF**

Teach-in of the switching outputs/characteristic output curve

The following steps are required for time-controlled teach-in of TOF sensors:

If you have changed the factory setting for teaching under `Input Mode`:

- ↳ On the display, activate menu item:
`Input -> Input Mode -> Teach`
- ↳ Position the measurement object at the desired distance.
- ↳ Activate the "teach in" input (pin 2) (by applying +U_B or GND, depending on the setting for Input Polarity, see chapter 7.2.1).

The duration of the activation of the teach input determines the teach step according to the table shown below.

Teach function	Duration T of teach signal
Switching output Q1 Teach point, see chapter 7.4.1	20 ... 80ms
Switching output Q2 (devices with 2 switching outputs) Teach point, see chapter 7.4.1	120 ... 180ms
Distance value for start of measurement range = 1 V or 4mA at analog output (pin 5)	220 ... 280ms
Distance value for end of measurement range = 10V or 20mA at analog output (pin 5)	320 ... 380ms

Table 7.10: Teach function in correspondence with the duration of the teach signal

The menu entries can be used to check that the teach values are properly accepted and to make any changes.

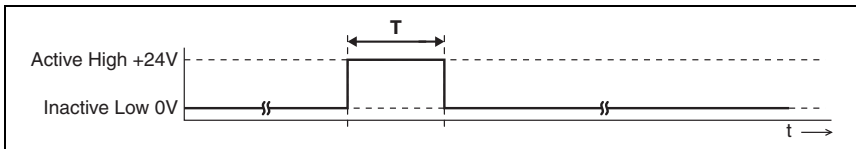


Bild 7.3: Teach signal curve for time-of-flight sensors



Notice

If the inactive level is permanently applied to the teach input, the teach input is locked.
If the menu is set to `Input -> Input Mode -> Input polarity -> Active Low +0V`, inverted input signals are used for teaching.

7.5 Trigger

No continuous measurement occurs while in Input Mode -> Trigger.

An ascending edge at the "teach in" input (pin 2) triggers a single measurement; the measurement value is present at the output until the next trigger event. This applies for ODS-models with analog output and serial output.

In this way it is possible to precisely perform individual measurements for the trigger signal in combination with a photoelectric sensor even in dynamic situations.

7.6 Measurement modes

In the Application menu, you can set 3 or 4 different measurement modes. The effect on the measurement behavior of the ODS depends on the device:

Triangulation sensors **TRI**

- **Standard:** Standard setting
- **Precision:** High accuracy, abt. 95% slower
- **Speed:** Fast measurement, abt. 30% faster
- **Light Suppression:** Higher insensitivity towards ambient light

The following table provides an overview of the effects of the individual parameters on the measurement function.

	Accuracy	Measurement time / updating	Ambient light	Varying diffuse reflection
Standard	+	+	+	+
Precision	++	--	+	+
Speed	-	++	+	+
Light Suppression	+	--	++	0

Tabelle 7.11: Effects of the measurement modes for triangulation sensors

Time-of-flight sensors **LTOF**

- **Standard:** Standard setting
- **Precision:** Factory setting, accuracy twice as high compared to standard, about 5 times slower
- **Speed:** Accuracy three times lower compared to standard, about 8 times faster

The following table provides an overview of the effects of the individual parameters on the measurement function.

	Accuracy	Measurement time	Measurement value update	Ambient light
Standard	+	10ms	+	++
Precision	++	50ms	--	++
Speed	-	1.2ms	++	++

Tabelle 7.12: Effects of the measurement modes for time-of-flight sensors

7.7 Measure filter

In the **APPLICATION** menu, you can set 5 different measurement filters. This affects the measurement behavior of the ODS as follows:

- **Off**: No filtering of the measurement values.
- **Averaging**: A sliding average is calculated and output from the last 2 ... 99 measurement values (set the number with **MEASUREMENT COUNT**). If the measurement value changes abruptly, the output value moves linearly over the course of n measurements from the old measurement value to the new measurement value. Thus, the time for measurement value updating is not affected by the number of measurements; the response time for distance changes becomes slower.
- **Center Value**: Filter out extreme values - the average value is calculated from every 10 ... 50 single measurements. The number of single measurements to be used is selected with **MEASUREMENT COUNT** (10, 20, 30, 40 or 50). The setting made under **FILTER DEPTH** specifies whether only the most extreme (**COARSE**), medium (**MEDIUM**) or minor deviations (**FINE**) should be filtered out.
- **Peak ¹⁾**: Filters out jumps in measurement values. Measurement values are only passed on if the difference to the last measurement value is not too large. Following a change in distance, the values are not output until the distance value has quieted back down. The setting under **PEAK WINDOW** is used to specify whether only medium (**MEDIUM**) measurement jumps are to be filtered out or if smaller (**FINE**) jumps are to be filtered as well.
- **Range ¹⁾**: The measurement value output is limited to the range which is defined with **RANGE LOWER POS.** and **RANGE UPPER POS.**, located down further in the menu. Example with **RANGE LOWER POS.** = 300mm and **RANGE UPPER POS.** = 400mm:
 - for distances < 300mm, 300mm is output as measurement value
 - between 300mm and 400mm, the actual measurement value is output
 - for distances > 400mm, 400mm is output as measurement value.



Notice

For **Center Value**, the time for measurement value updating increases considerably!

The following table provides an overview of the effects of the individual parameters on the measurement function.

	Updating measurement time	Response time to small changes in distance	Response time to large changes in distance	Filtering individual incorrect measurements	Filtering cumulative incorrect measurements
Off	+	+	+	--	--
Averaging	+	-	-	0	-
Center Value	--	-	-	++	+
Peak	0	+	0	+	-
Range	+	+	-	0	0

Tabelle 7.13: Effects of Measure Filter

1) Sensors with an IO-Link interface do not have this menu item available.

7.8 Distance calibration

Using the `Distance Correct.`¹⁾ menu item, it is possible to influence the measured distance value.



Notice

Offset and Preset are used for correcting the measurement value by a fixed amount. Referencing, on the other hand, increases the accuracy of measurements in the distance range near the taught reference distance. To obtain the most exact measurement accuracy possible, referencing should be performed as close to the measurement as possible. Execution of the referencing function via the teach input is ideally suited for this.

7.8.1 Preset or Offset

Deviations which occur while mounting the ODS can be compensated for by the **Offset**¹⁾ or **Preset**¹⁾ parameter:

- For **Offset**, a fixed value and sign are specified.
- For **Preset**, a nominal measurement value is specified; a measurement is then performed using an object located at the desired nominal distance. The **Offset** parameter mentioned above is changed as a result of this measurement.



Notice

If calculation of the offset results in negative measurement values, zero is output at the interface and on the display.

Setting the offset¹⁾

Configuration is performed using the key pad and display:

↵ Select:

Application -> Distance Correct. -> Offset/Preset

↵ Then enter the offset value:

Application -> Offset

The set offset value is added to the measured distance value of the sensor.

Example:

Measurement value of the ODS 96B: 1500 mm

Input: Offset: -100 mm

Output on the display and at the interface: 1400mm

¹⁾ Sensors with an IO-Link interface do not have this menu item available.

Setting the preset ¹⁾

Configuration is performed using the key pad and display:

↳ Select:

Application -> Distance Correct. -> Offset/Preset

↳ Then enter the preset value:

Application -> Preset Position

↳ Position an object at the desired preset distance.

↳ Perform a preset measurement:

Application -> Pres.-Offs. Calc. -> Execute

The offset value is automatically calculated from the measurement value and nominal measurement value (preset value) and entered as the offset in the configuration.

Example:

Input:	Preset value: 1400mm,
Object dist. 1300mm in front of ODSL 96B:	Preset Calculation ...active, trigger measurement with Execute, an offset of +100mm is automatically stored
Object distance 1300mm:	Output on display and at interface: 1400mm
Object distance 1400mm:	Output on display and at interface: 1500mm



Notice

Deactivating Offset / Preset ¹⁾

If the Preset or Dist. Referencing function is activated in the Input menu, then first activate another function in the Input menu: Teach Time Ctrl., Teach Slope Ctrl., Teach, Trisser or Activation. Afterwards, the offset correction can be deactivated by setting the offset value to zero or by selecting a different mode under Distance Correct. In the latter case, when the "Offset/Preset" mode is reselected, the most recently set offset and preset values are again available.


¹⁾ Sensors with an IO-Link interface do not have this menu item available.

7.8.2 Referencing for triangulation sensors

ODS triangulation sensors have a referencing function for the internal calibration of the sensor.



Notice

The referencing function is not available for time-of-flight sensors ().

By carrying out the integrated reference measurement function before a measurement, the sensor's accuracy can be improved by having the ODS also measure the environmental conditions during reference measurement. The corrective value determined here is used if referencing is activated.

↳ Select:

Application -> Distance Correct. -> Referencing

↳ Then enter the reference value:

Application -> Ref. Position

↳ Before referencing, position an object in front of the ODS at the desired reference distance.

↳ Perform a reference operation:

- **Using a command:** In remote control mode, see chapter 4.6.2
- **Using teach-in:** To do this, use the menu or software to activate the Input -> Input Mode -> Dist. Referencing function. Then **each time** the teach input (pin 2) is activated, referencing is performed.
- **Using a menu command:** Use the menu or software to set Application -> Distance Correct. -> Referencing, and then execute the Application -> Ref. Calculation -> Execute menu command. This starts a **one-time** referencing operation.

The referencing correction is deactivated by selecting a different mode under Distance Correct. (Off or Offset/Preset). When the Referencing mode is again selected, the most recently set reference distance is again available. If re-referencing is not performed, the old corrective values may result in incorrect measurement values.



Notice

In particular, the referencing function should be performed for changing environmental conditions. In addition, you should perform referencing prior to all measurements which have elevated accuracy requirements.

While executing the referencing function (duration abt. 2s), no measurements are possible; the reference object must remain still during this period!



Notice

For the ODS... 9/96B, referencing is a selective calibration on a target located at a specified reference distance. The entire measurement system is not referenced as it is with the ODSL 30.

7.8.3 Teach-in of Offset and Preset via the binary input

↳ Activate the desired function through the Input menu:

Input Mode -> Preset or Distance Referencing (only )

↳ Before distance calibration, position an object in front of the sensor at the desired distance.

Distance calibration with triangulation sensors 

↳ Activate the "teach in" input (pin 2) (by applying +U_B or GND, depending on the setting for Input Polarity, see chapter 7.2.1).

The duration of the activation of the teach input determines the teach step according to the table shown below. The teach event is indicated by the flashing of the LEDs and on the display.

Teach function	Duration of teach signal	Green LED	Yellow LED
Preset or Distance Referencing	2 ... 4s	flash synchronously	

Table 7.14: Distance calibration via binary input with triangulation sensors

Distance calibration for time-of-flight sensors 

↳ Activate the "teach in" input (pin 2) (by applying +U_B or GND, depending on the setting for Input Polarity, see chapter 7.2.1).

The duration of the activation of the teach input determines the teach step according to the table shown below.

Teach function	Duration of teach signal
Preset	20 ... 80ms

Table 7.15: Distance calibration via binary input with time-of-flight sensors

8 Configuration software

General description

The configuration software make it possible to operate all ODSL 9, ODS... 96B/ODK 96 B, with the exception of the sensors with an IO-Link interface.

For sensors with IO-Link, please observe the notes in chapter 4.5 and chapter 5.5.

The configuration software can be used together with a connected distance sensor to create device configurations.

Without a connected distance sensor the program works in the Demo mode.

You can download the software on the Internet from www.leuze.com.

8.1 Connecting to a PC

The distance sensor is connected to a PC via the UPG 10 configuration adapter. The adapter is simply inserted between the sensor and the connection cable. The UPG 10 is connected to the PC via the serial interface cable that ships with the UPG 10.

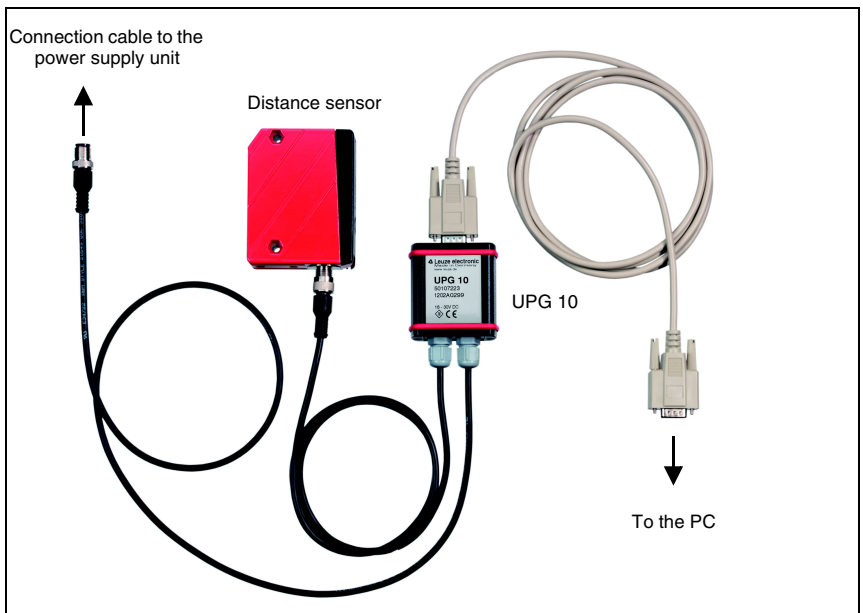


Bild 8.1: Connecting the distance sensor via the UPG 10 configuration adapter

8.2 Installing the configuration software

Requirements for the installation of the configuration software:

- Pentium® or faster Intel® processor (or compatible models, e.g. AMD®)
- At least 64 MB free main memory (RAM)
- Hard disk with at least 30 MB free memory
- RS 232 interface for sensor configuration
- Microsoft® Windows 98/NT/2000/XP/7

Installation

You can download the configuration software on the Internet from www.leuze.com. The software is located under the Download tab of the selected distance sensor.

- ↳ Copy the file into a suitable folder on your storage drive and unpack the zip file.
- ↳ Start the installation by double-clicking on the "setup.exe" file. Administrator privileges are necessary for this purpose.

8.3 Starting the program

After successful installation and restart of the computer, the configuration software is ready to use.

- ↳ Select the ODS configuration software icon from the program group.

If no sensor is connected, the software boots in demo mode.



Notice

The ODS configuration software automatically finds the UPG 10 on the serial ports COM1 to COM10. If a non-supported COM port, e.g. COM11, is assigned during the automatic installation of the serial driver, then a COM port supported by the software must be assigned to operate the UPG 10.

You can adapt the COM port setting as follows:

- ↳ In the operating system, assign the value **1** to the system variable "**devmgr_show_nonpresent_devices**" (System control -> System -> Advanced system settings -> Environmental variable).

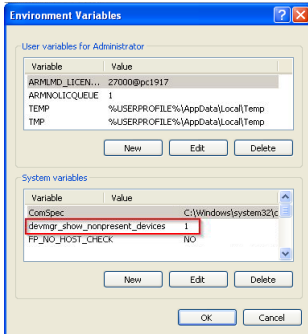


Bild 8.2: System variable "devmgr_show_nonpresent_devices"

- ↳ Open the device manager and in the "View" menu select the menu item "Show suppressed devices" (System control -> Device manager -> View). Now, under "Connections", all interfaces (including unconnected ones) are shown to which a COM port has been assigned.
- ↳ Assign a serial port, COM1 to COM10, to the COM port to which the UPG 10 is connected (Select COM port -> Properties -> Connection settings-> Advanced -> COM connection number).

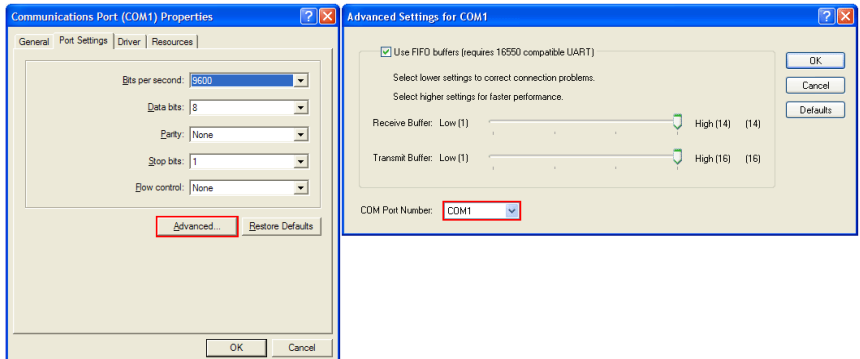


Bild 8.3: COM port properties - connection settings "Advanced"

8.4 ODS configuration software main window

After selecting a device type and confirming with OK, the following window appears:

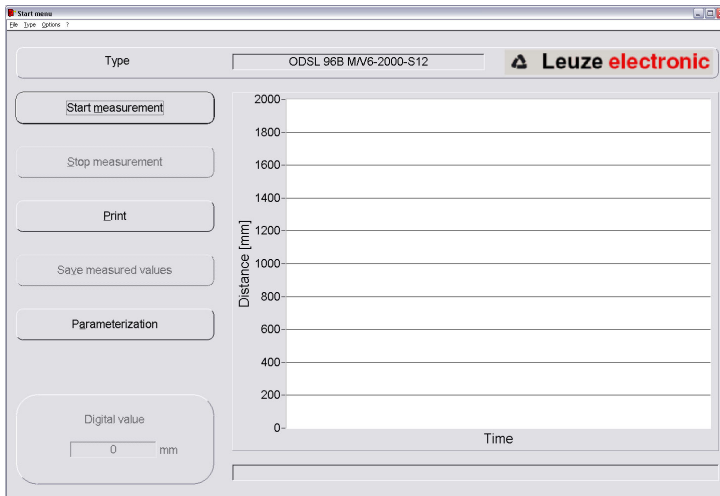


Bild 8.4: ODS configuration software - main window

The **menu bar** of the ODS configuration software offers the following functions

- **File** -> Exit program
- **Options** -> Language and interface selection. German and English are the available languages. Under Interface, you must select the COM port to which the distance sensor is connected. The necessary communication parameters are automatically set for the interface.

Additional functions can be executed in the **main window**:

- **Start measurement** and **Stop measurement** are used to graphically represent the measurement values in the main window.

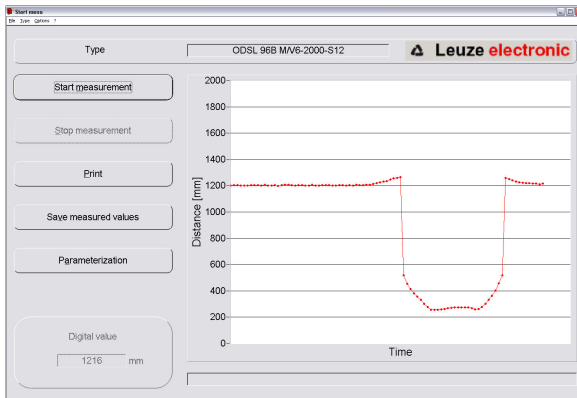


Bild 8.5:ODS configuration software - measurement

- Use **Print** to send the currently detected measurement curve to the default Windows printer.
- **Save measured values** saves the current measurement values in a text file
- **Parameterization** opens the configuration window, see next chapter

8.5 Configuration window

The individual menu items are self-explanatory and correspond to the menus of the display in the distance sensor. Explanations of the possible settings can be found in chapter 7.2.

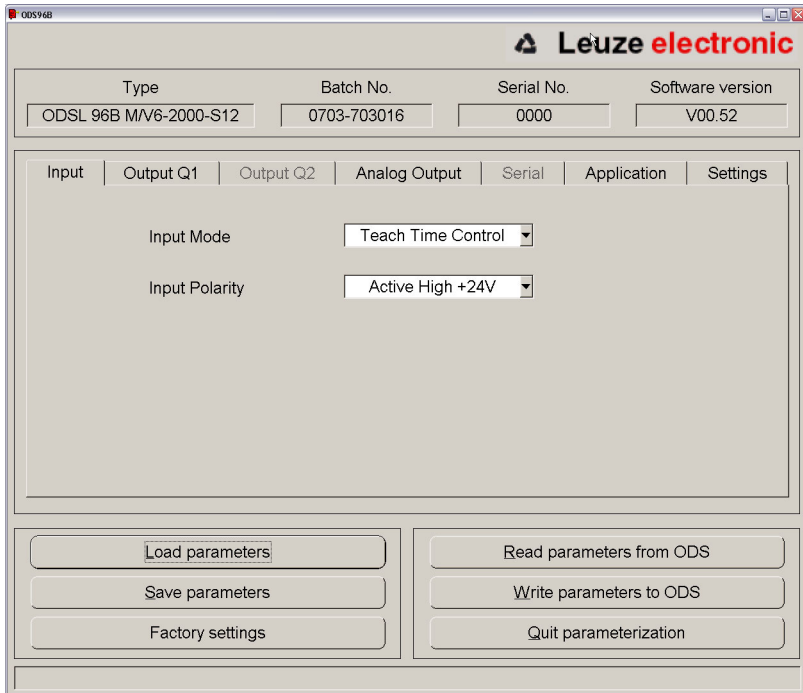


Bild 8.6: ODS configuration software - configuration window

8.5.1 Description of the command buttons

The command buttons at the bottom of the screen have the following functions:

Load parameters

Loads a saved configuration from the hard disk.

Save parameters

Saves a created configuration on the hard disk.

Factory Settings

Resets the connected distance sensor to factory settings.

Read parameters from ODS

Reads and displays the configuration of the connected ODS 96B.

Write parameters to ODS

Saves the current configuration in the non-volatile parameter memory of the ODS 96B

Quit parameterization

Ends the program

**Notice**

Leuze electronic can only deliver distance sensors with default settings. You as customer are responsible for correct storage of your changed data sets. Back-up your device configuration on data carriers.

9 Specifications ODSL 9

9.1 Optical data and certifications

	ODSL 9/...-100-S12 Laser	ODSL 9/...-200-S12 Laser	ODSL 9/...-450-S12 Laser	ODSL 9/...C1-450-S12 Laser	ODSL 9/...-650-S12 Laser
Optical data					
Measurement ranges ¹⁾	50 ... 100mm	50 ... 200mm	50 ... 450mm	50 ... 450mm	50 ... 650mm
Resolution	0.01 mm	0.01 ... 0.1 mm	0.1 mm	0.1 mm	0.1 ... 0.5 mm
Light source	laser	laser	laser	laser	laser
Wavelength	655nm (red light)	655nm (red light)	655nm (red light)	655nm (red light)	655nm (red light)
Laser class (acc. to IEC 60825-1:2007, 21 CFR 1040.10 with Laser Notice No. 50)	2	2	2	1	2
Light spot diameter	divergent, 1 x 1 mm ² at 100mm distance	divergent, 1 x 1 mm ² at 100mm distance	divergent, 1 x 1 mm ² at 450mm distance	divergent, 1 x 1 mm ² at 450mm distance	divergent, 1 x 1 mm ² at 450mm distance
Error limits ²⁾					
Absolute measurement accuracy ¹⁾	± 0.5 %	± 0.5 ... ± 1 %	± 1 %	± 1 %	± 1 %
Repeatability ³⁾	± 0.25 %	± 0.25 ... 0.5 %	± 0.5 %	± 0.5 %	± 0.5 %
B/W detection thresholds (6%/90%)	≤ 0.5 %	≤ 0.5 %	≤ 0.5 %	≤ 0.5 %	≤ 0.5 %
Temperature compensation	yes ⁴⁾	yes ⁴⁾	yes ⁴⁾	yes ⁴⁾	yes ⁴⁾
Timing					
Measurement time ¹⁾	2 ms	2 ms	2 ms	4 ms	2 ms
Response time	≤ 6 ms	≤ 6 ms	≤ 6 ms	≤ 12 ms	≤ 6 ms
Delay before start-up	≤ 300 ms	≤ 300 ms	≤ 300 ms	≤ 300 ms	≤ 300 ms
Certifications					
UL 508, C22.2 No. 14-13 ⁵⁾⁶⁾	Yes	Yes	Yes	Yes	Yes

- 1) Luminosity coefficient 6 ... 90%, complete measurement range, "Standard" operating mode, at 20 °C, medium range U_B, measurement object ≥50x50mm²
- 2) After an operating time of 20 min., the device has reached the operating temperature required for an optimal measurement.
- 3) Same object, identical environmental conditions, measurement object ≥ 50 x 50mm²
- 4) Typ. ± 0.02 %/K
- 5) For UL applications: only for use in "Class 2" electrical circuits according to NEC
- 6) These sensors shall be used with UL Listed Cable assemblies rated 30 V, 0.5 A min, in the field installation, or equivalent (categories: CYJV/CYJV7 or PVVA/PVVA7)

9.2 Electrical data, installation data

	ODSL 9/ C...	ODSL 9/ V...	ODSL 9/ D...	ODSL 9/(C)66...	ODSL 9/L...
Electrical data					
Operating voltage U_B ¹⁾	18 ... 30VDC (incl. residual ripple)				
Residual ripple	$\leq 15\%$ of U_B				
Bias current	≤ 180 mA				
Switching outputs ²⁾	1 push/pull output, teachable			2 push/pull outputs, partially teachable	
Signal voltage high/low	$\geq (U_B - 2V) / \leq 2V$				
Analog output	current 4 ... 20 mA, $R_L \leq 500 \Omega$	voltage 1 ... 10V ³⁾ , $R_L \geq 2 \text{ k}\Omega$			
Output current	max. 100 mA for each push/pull output				
Serial interface RS 232, RS 485			9600 baud (factory setting), baud rate configurable		
Transmission protocol			2/3 byte transmission, const. data flow, see chapter 4.6		
IO-Link					COM 2 (38400 baud)
Mechanical data					
Housing	plastic				
Optics cover	glass				
Weight	abt. 50g				
Connection type	M12 connector, 5-pin				
Environmental data					
Ambient temp. (operation/storage)	-20 ... +50 °C / -30 ... +70 °C				
Ambient light limit	≥ 30 kLux				
Protective circuit ⁴⁾	1,2,3				
VDE safety class ⁵⁾	II, all-insulated				
Protection class	IP 67				
Standards applied	IEC 60947-5-2				

- 1) For UL applications: only for use in "Class 2" electrical circuits according to NEC
- 2) The push-pull switching outputs must not be connected in parallel
- 3) Factory setting, 1 ... 10V / 0 ... 10V / 1 ... 5V / 0 ... 5V adjustable
- 4) 1=transient protection, 2=polarity reversal protection, 3=short-circuit protection for all outputs
- 5) Rating voltage 50 V AC with closed cover

9.3 Dimensioned and connection drawings

ODSL 9 laser models

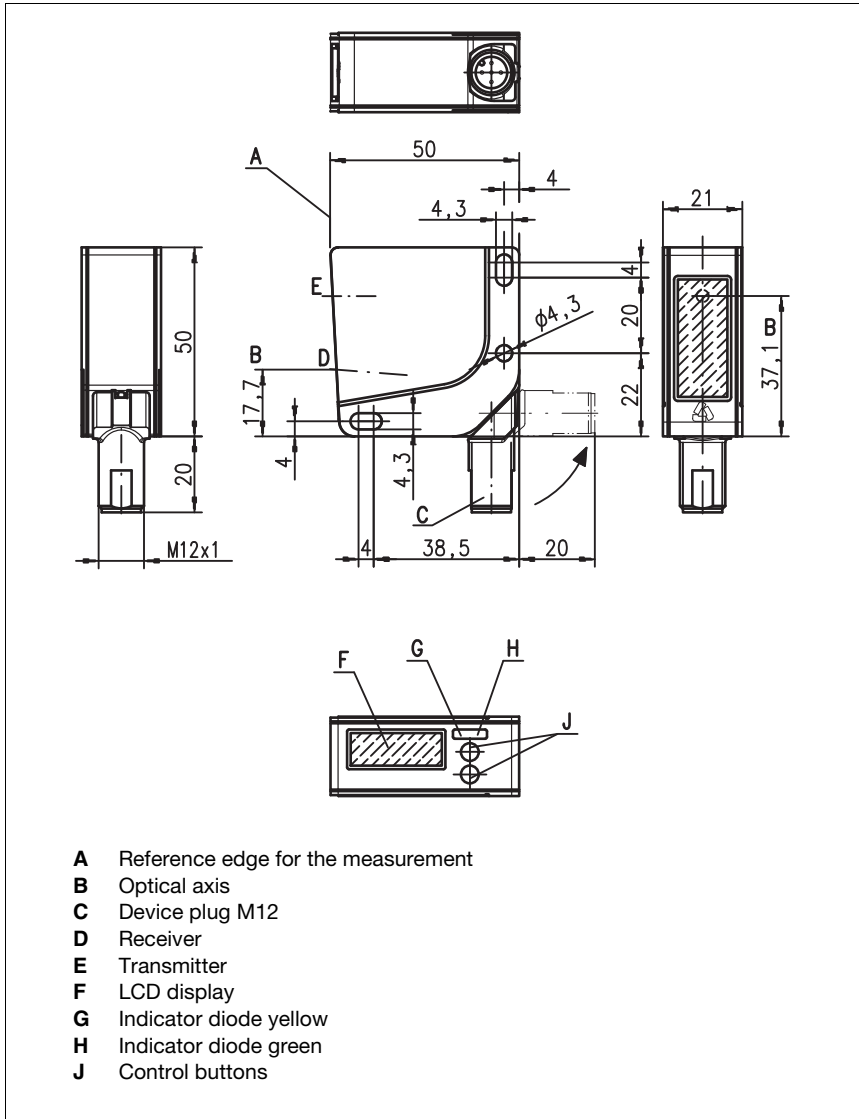


Bild 9.1: Dimensioned drawing ODSL 9...

ODSL 9 /C6 with analog current output, 1 input and 1 switching output

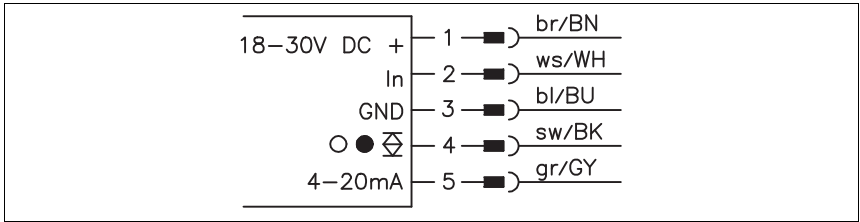


Bild 9.2: Electrical connection ODSL 9/C6...

ODSL 9 /C66 with analog current output and 2 switching outputs

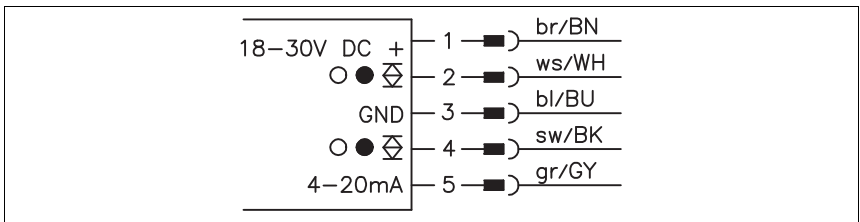


Bild 9.3: Electrical connection ODSL 9/C66...

ODSL 9 /V6 with analog voltage output, 1 input and 1 switching output

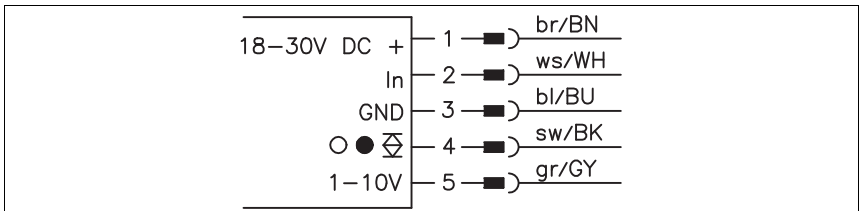


Bild 9.4: Electrical connection ODSL 9/V6...

ODSL 9/V66 with analog voltage output and 2 switching outputs

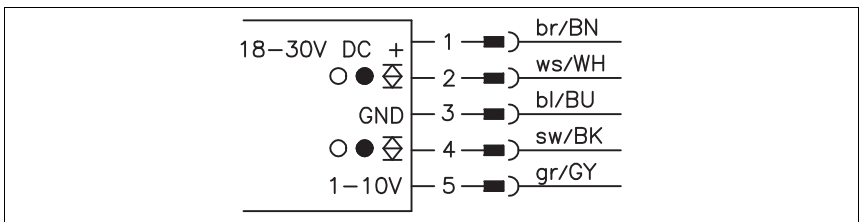


Bild 9.5: Electrical connection ODSL 9/V66...

ODSL 9/L with IO-Link interface

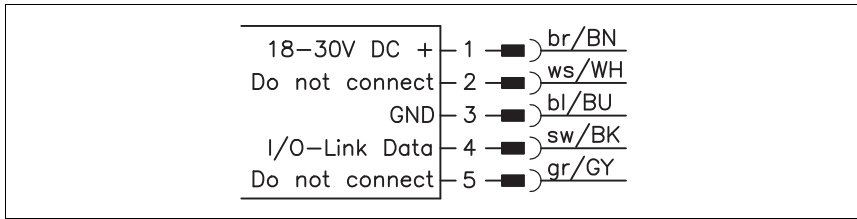


Bild 9.6: Electrical connection ODSL 9/L...

ODSL 9/D26 with serial RS 232 interface

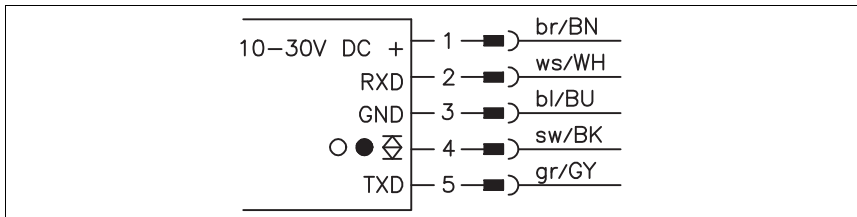


Bild 9.7: Electrical connection ODSL 9/D26...

ODSL 9/D36 with serial RS 485 interface

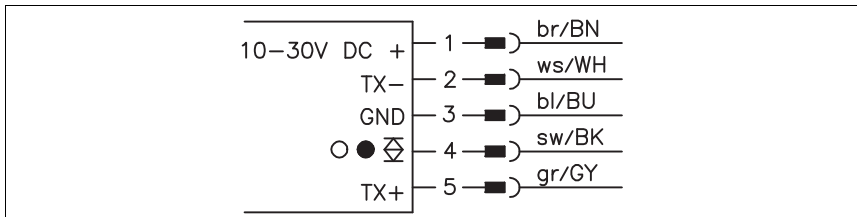


Bild 9.8: Electrical connection ODSL 9/D36...

ODSL 9/66 with 2 teachable push/pull outputs

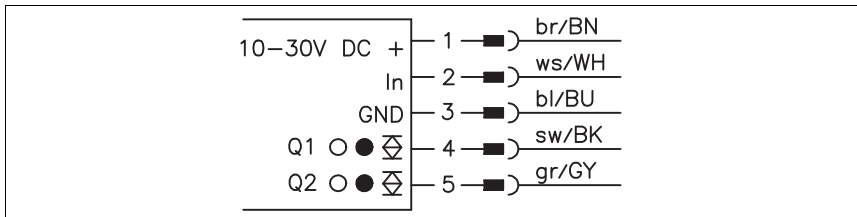


Bild 9.9: Electrical connection ODSL 9/66...

10 Specifications ODS... 96B/ODK... 96B

10.1 Optical data and certifications for triangulation sensors ▲ TRI

	ODS(R) 96B Red light / infrared light	ODSL(R) 96B Laser	ODSL 96B...C1... Laser
Optical data			
Measurement ranges ¹⁾	100 ... 600mm 120 ... 1400mm	60 ... 2000mm 150 ... 2000mm 150 ... 800mm ("S") 150 ... 1200mm ("XL")	150 ... 1500mm ("S")
Resolution	0.1 ... 0.5mm (600mm) 0.1 ... 1mm (1400mm)	1 ... 3mm 0.1 ... 0.5mm ("S") 0.1 ... 1.5mm ("XL")	0.1 ... 2mm ("S")
Light source	LED (modulated light)	laser (modulated light)	laser (modulated light)
Wavelength	880nm (infrared) 635nm (red light)	655nm	655nm
Laser class (acc. to IEC 60825-1:2007, 21 CFR 1040.10 with Laser Notice No. 50)	–	2	1
Light spot diameter	abt. 15mm at 600mm distance	divergent min. 2mm x 6mm at 2000mm distance divergent, 1mm x 1mm at 800mm distance ("S") divergent, 15mm x 4mm at 800mm distance ("XL")	divergent, 1mm x 1mm at 800mm distance ("S")
Error limits ²⁾			
Absolute measurement accuracy ¹⁾	± 1.5%	60 ... 150mm: ± 3mm 150 ... 2000mm: ± 1.5%	± 1.5%
Repeatability ³⁾	± 0.5%	± 0.5%	± 0.5%
B/W detection thresholds (6%/90%)	≤ 1%	≤ 1%	≤ 1%
Temperature compensation	yes ⁴⁾	yes ⁴⁾	yes ⁴⁾
Timing			
Measurement time	1 ... 5ms ¹⁾	1 ... 5ms ¹⁾	12 ... 60ms ¹⁾⁵⁾
Response time	≤ 15ms	≤ 15ms	≤ 180ms ¹⁾
Delay before start-up	≤ 300ms	≤ 300ms	≤ 300ms
Certifications			
UL 508, C22.2No.14-13 ⁶⁾⁷⁾	yes	yes	no

- 1) Luminosity coefficient 6 ... 90%, complete measurement range, "Standard" operating mode, at 20 °C, medium range U_B , measurement object $\geq 50 \times 50 \text{ mm}^2$
- 2) After an operating time of 20 min., the device has reached the operating temperature required for an optimal measurement.
- 3) Same object, measurement object $\geq 50 \times 50 \text{ mm}^2$
- 4) Typ. $\pm 0.02 \text{ \%}/\text{K}$
- 5) Measurement time in factory setting (ambient light measure mode), operation in other measure modes is not recommended
- 6) For UL applications: only for use in "Class 2" electrical circuits according to NEC
- 7) These sensors shall be used with UL Listed Cable assemblies rated 30 V, 0.5 A min, in the field installation, or equivalent (categories: CYJV/CYJV7 or PWA/PWA7)

10.2 Optical data and certifications for time-of-flight sensors JLTOF

	ODSL 96B Laser	ODSIL 96B Laser	ODKL 96B Laser
Optical data			
Measurement ranges	300 ... 10,000mm (90% diffuse reflection) 300 ... 6000mm (6 ... 90% diffuse reflection)	300 ... 10,000mm (90% diffuse reflection) 300 ... 6000mm (6 ... 90% diffuse reflection)	300 ... 25000mm onto high gain tape
Resolution	3mm	3mm	3mm
Light source	laser	laser	laser
Wavelength	658nm (red light)	785nm (infrared light)	658nm (red light)
Alignment laser wavelength		658nm (red light)	
Laser class (acc. to IEC 60825-1:2007, 21 CFR 1040.10 with Laser Notice No. 50)	2	1	2
Light spot diameter	divergent, 7 x 7mm ² at 10,000mm distance	divergent, 7 x 7mm ² at 10,000mm distance	divergent, 7 x 7mm ² at 10,000mm distance
Error limits (relative to 6000 mm) ¹⁾			
Absolute measurement accuracy	± 0.5%	± 0.5%	± 0.3% ²⁾
Repeatability ³⁾	± 5 mm	± 5 mm	± 5 mm
B/W detection thresholds (6%/90%)	± 10 mm	± 10 mm	–
Temperature drift	± 1.5mm/K	± 1.5mm/K	± 1.5mm/K
Timing			
Measurement time	Operating mode "Speed": 1.4 ms "Standard": 10 ms "Precision": 30 ms ⁴⁾	Operating mode "Speed": 2.8 ms "Standard": 20 ms "Precision": 100 ms ³⁾	Operating mode "Speed": 1.4 ms "Standard": 10 ms "Precision": 50 ms ³⁾
Delay before start-up	≤ 300 ms	≤ 300 ms	≤ 300 ms
Certifications			
UL 508, C22.2No.14-13 ⁵⁾	yes	yes	yes

- 1) After an operating time of 20 min., the device has reached the operating temperature required for an optimal measurement.
- 2) Relative to 25,000mm
- 3) Same object, measurement object ≥ 50 x 50 mm²
- 4) Factory setting
- 5) For UL applications: only for use in "Class 2" electrical circuits according to NEC
- 6) These sensors shall be used with UL Listed Cable assemblies rated 30 V, 0.5 A min, in the field installation, or equivalent (categories: CYJV/CYJ7 or PWA/PWA7)

10.3 Electrical data, installation data: triangulation sensors

	ODS(L/R) 96B M/C...	ODS(L/R) 96B M/V...	ODS(L/R) 96B M/D...	ODS(L/R) 96B M/(C)66...	ODS(L/R) 96B L...
Electrical data					
Operating voltage U_B ¹⁾	18 ... 30VDC (incl. residual ripple)				
Residual ripple	$\leq 15\%$ of U_B				
Bias current	≤ 150 mA				
Switching outputs ²⁾	1 push/pull output, teachable			2 push/pull outputs, teachable	
Signal voltage high/low	$\geq (U_B - 2V) / \leq 2V$				
Analog output	current 4 ... 20mA, $R_L \leq 500\Omega$	voltage 1 ... 10V ³⁾ , $R_L \geq 2k\Omega$			
Output current	max. 100mA for each push/pull output				
Serial interface RS 232, RS 485			9600 baud, configurable baud rate		
Transmission protocol			2/3 byte trans- mission, const. data flow, see chapter 4.6		
IO-Link					COM 2 (38400 baud)
Mechanical data					
Housing	diecast zinc				
Optics cover	glass				
Weight	380g				
Connection type	M12 connector				
Environmental data					
Ambient temp. (operation/storage)	-20 ... +50°C / -30 ... +70°C				
Ambient light limit	≥ 5 klux				
Protective circuit ⁴⁾	1,2,3				
VDE safety class ⁵⁾	II, all-insulated				
Protection class	IP 67, IP 69K ⁶⁾				
Standards applied	IEC 60947-5-2, 21 CFR 1040.10				


- 1) For UL applications: only for use in "Class 2" electrical circuits according to NEC
- 2) The push-pull switching outputs must not be connected in parallel
- 3) Factory setting, 1 ... 10V / 0 ... 10V / 1 ... 5V / 0 ... 5V adjustable
- 4) 1=transient protection, 2=polarity reversal protection, 3=short-circuit protection for all outputs
- 5) Rating voltage 250 V AC with closed cover
- 6) IP 69K test acc. to DIN 40050 part 9 simulated, high pressure cleaning conditions without the use of additives, acids and bases are not part of the test.

10.4 Electrical data, installation data: time-of-flight sensors JLTOF

	OD...L 96B M/ C...	OD...L 96B M/ V...	OD...L 96B M/ D...	OD...L 96B M/ (C)66...	OD...L 96B M/ L...
Electrical data					
Operating voltage U_B	18 ... 30VDC (incl. residual ripple)				
Residual ripple	$\leq 15\%$ of U_B				
Bias current	$\leq 150\text{mA}$				
Switching outputs ¹⁾	1 push/pull output, teachable			2 push/pull outputs	
Signal voltage high/low	$\geq (U_B - 2V) / \leq 2V$				
Analog output	current 4 ... 20mA, $R_L \leq 500\Omega$	voltage 1 ... 10V ²⁾ , $R_L \geq 2k\Omega$			
Output current	max. 100mA for each push/pull output				
Serial interface RS 232, RS 485			9600 baud, configurable baud rate		
Transmission protocol			2/3 byte trans- mission, const. data flow, see chapter 4.6		
IO-Link					COM 2 (38400 baud)
Mechanical data					
Housing	diecast zinc				
Optics cover	glass				
Weight	380g				
Connection type	M12 connector				
Environmental data					
Ambient temp. (operation/storage)	-20 ... +50°C / -30 ... +70°C				
Ambient light limit	$\geq 50\text{kLux}$				
Protective circuit ³⁾	1,2,3				
VDE safety class ⁴⁾	II, all-insulated				
Protection class	IP 67, IP 69K ⁵⁾				
Standards applied	IEC 60947-5-2, 21 CFR 1040.10 and 1040.11				

- 1) The push-pull switching outputs must not be connected in parallel
- 2) Factory setting, 1 ... 10V / 0 ... 10V / 1 ... 5V / 0 ... 5V adjustable
- 3) 1=transient protection, 2=polarity reversal protection, 3=short-circuit protection for all outputs
- 4) Rating voltage 250 V AC with closed cover
- 5) IP 69K test acc. to DIN 40050 part 9 simulated, high pressure cleaning conditions without the use of additives, acids and bases are not part of the test.

10.5 Dimensioned and connection drawings

ODS 96B red-light and infrared models, triangulation sensors 

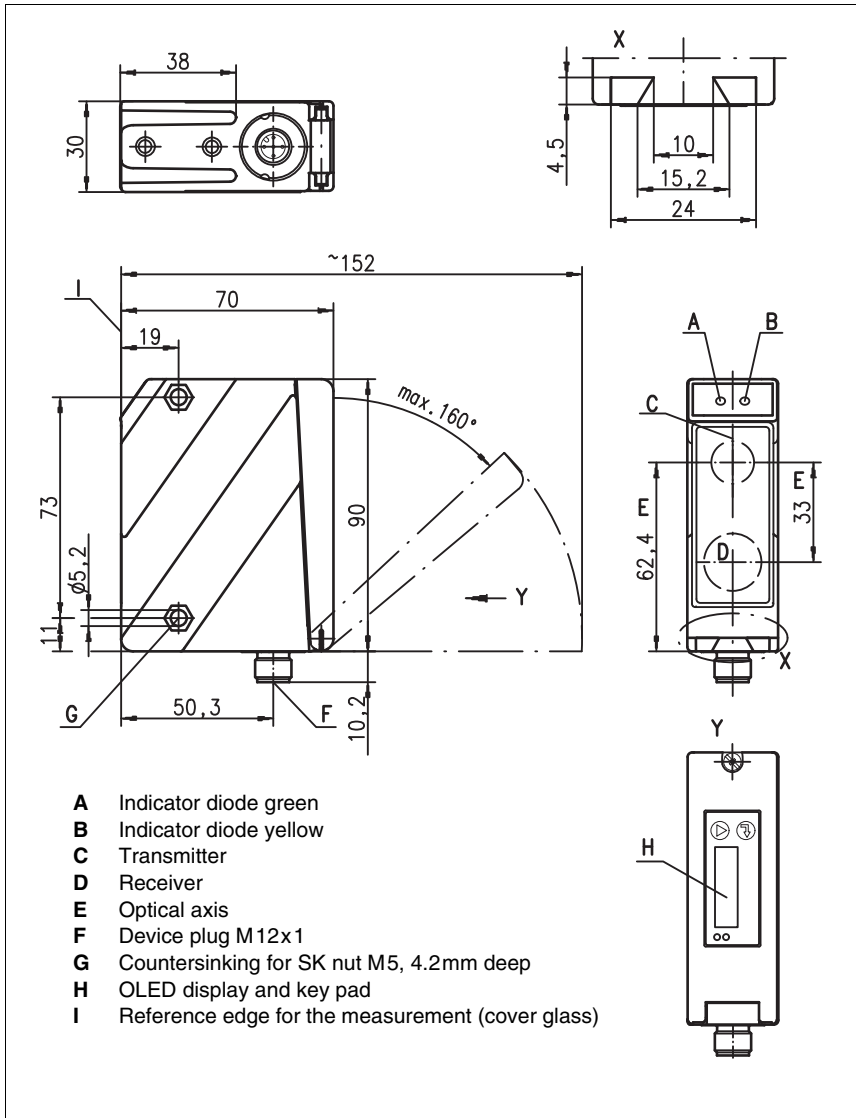


Bild 10.1: Dimensioned drawing ODS 96B..., ODSR 96B...

ODSL... 96B laser models, triangulation sensors **TRI**

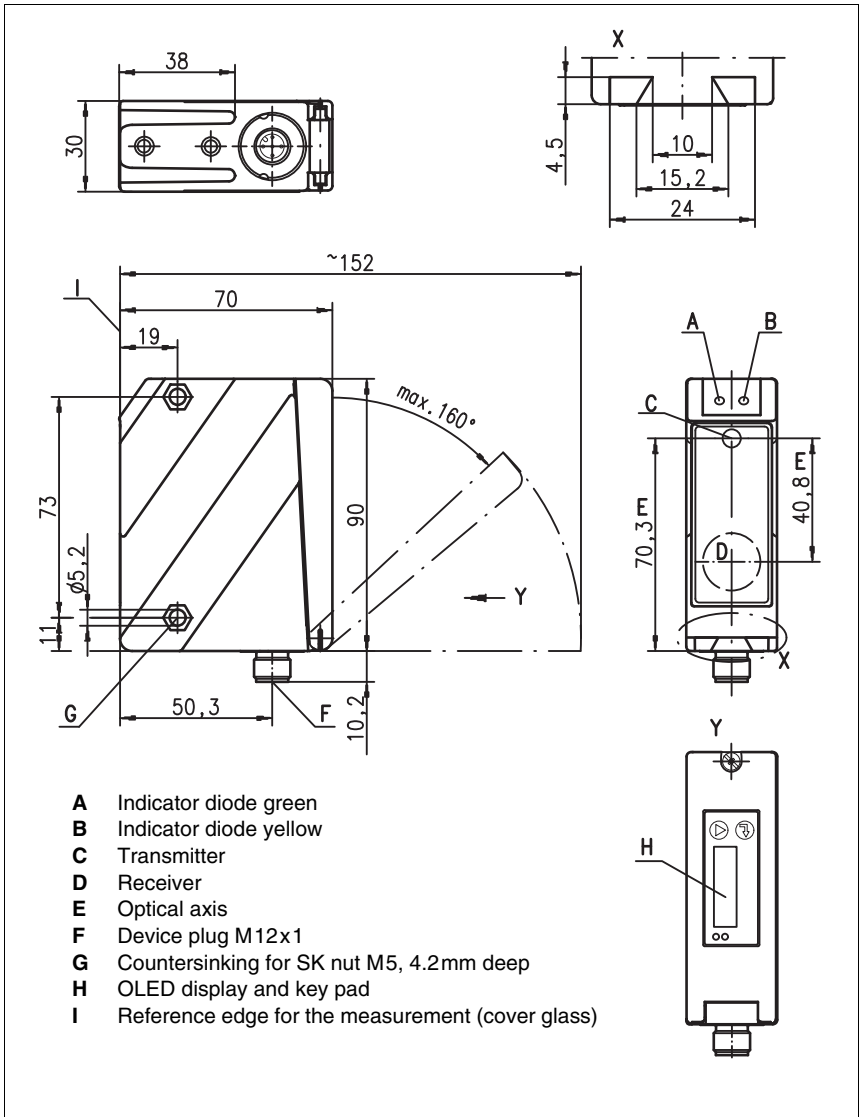


Bild 10.2: Dimensioned drawing triangulation sensors ODSL(R) 96B...

ODSL 96B/ODKL 96B laser models, time-of-flight sensors JLTof

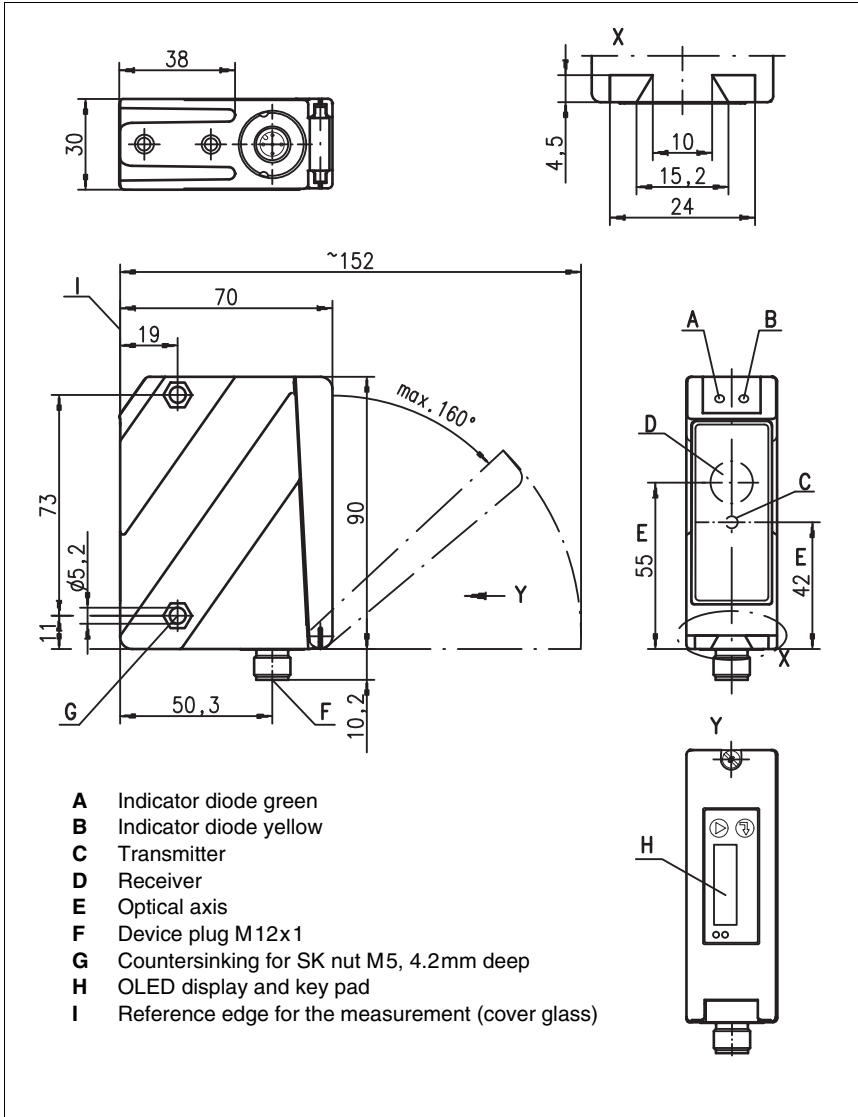


Bild 10.3: Dimensioned drawing time-of-flight sensors ODSL 96B.../ODKL 96B...

ODSIL 96B laser models, time-of-flight sensors JLTOF

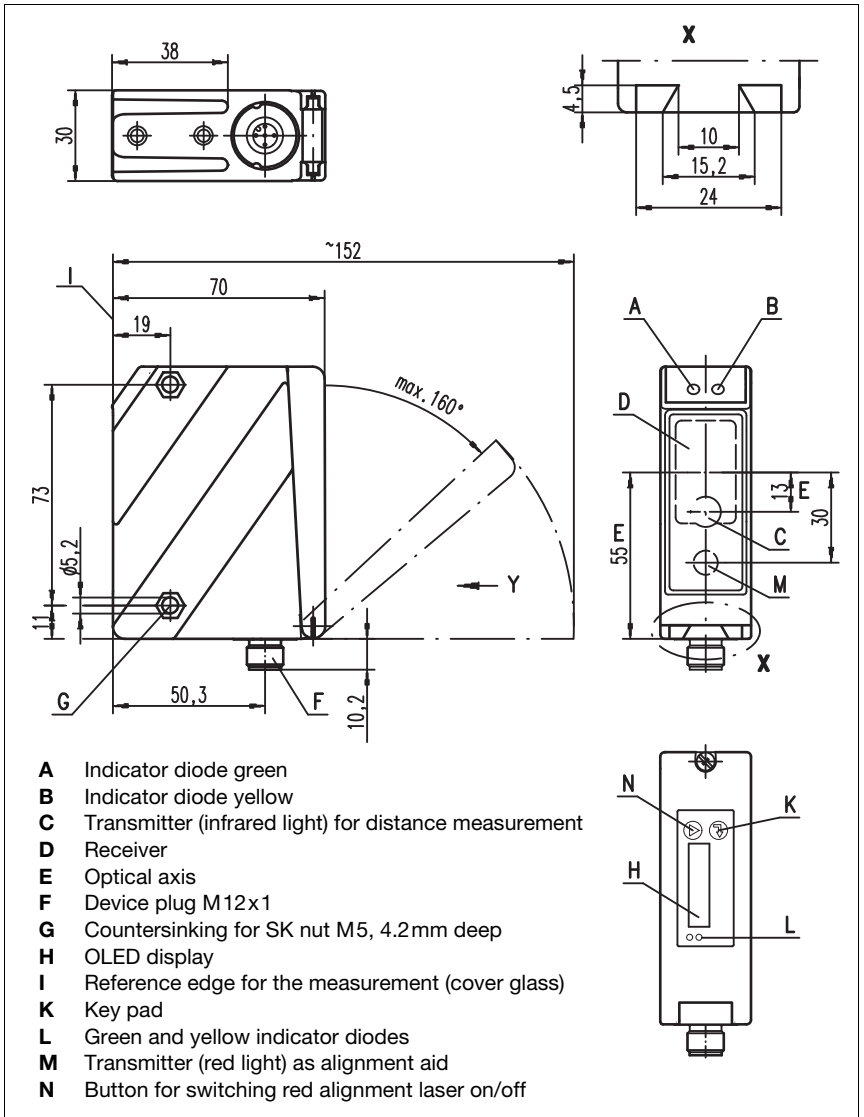


Bild 10.4: Dimensioned drawing of ODSIL 96B... time-of-flight sensors

ODS... 96B/ODK...96B M/C with analog current output

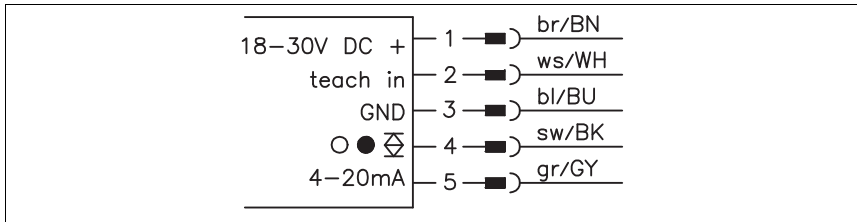


Bild 10.5:Electrical connection ODS... 96B/ODK... 96B M/C...

ODS... 96B/ODK...96B M/C with analog current output and 2 warning or switching outputs

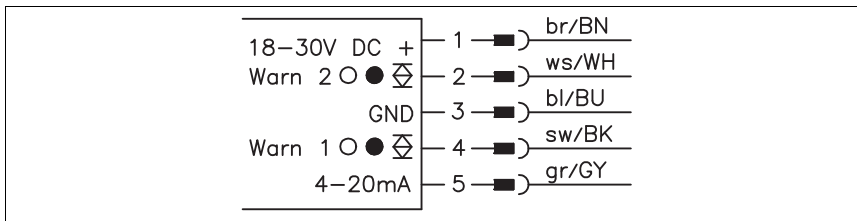


Bild 10.6:Electrical connection ODS... 96B/ODK... 96B M/C66...

ODS... 96B/ODK...96B M/V with analog voltage output

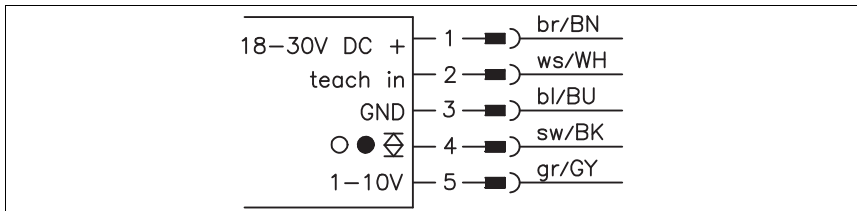


Bild 10.7:Electrical connection ODS... 96B/ODK... 96B M/V...

ODS... 96B/ODK... 96B M/L with IO-Link interface

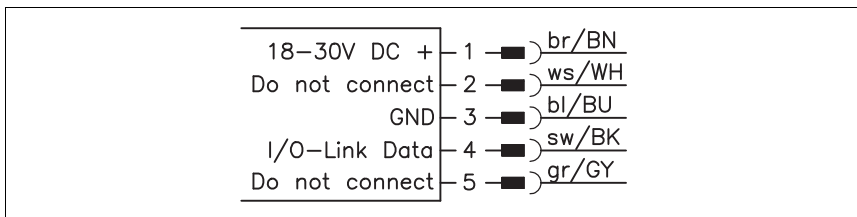


Bild 10.8:Electrical connection ODS... 96B/ODK... 96B M/L...

ODS... 96B/ODK...96B M/D26 with serial RS 232 interface

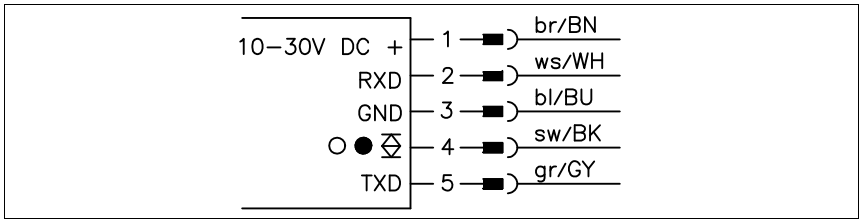


Bild 10.9:Electrical connection ODS... 96B/ODK... 96B M/D26...

ODS... 96B/ODK...96B M/D36 with serial RS 485 interface

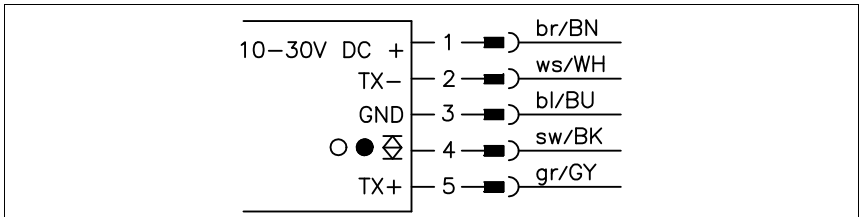


Bild 10.10:Electrical connection ODS... 96B/ODK... 96B M/D36...

ODS... 96B/ODK...96B M/66 with 2 teachable push/pull outputs

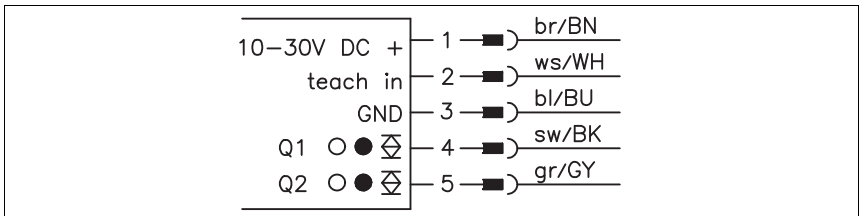


Bild 10.11:Electrical connection ODS... 96B/ODK... 96B M/66...

11 Type overview and accessories

11.1 ODSL 9 type overview

Type designation	Description	Part no.
ODSL 9 with laser transmitter, measurement range 50 ... 650mm		
ODSL 9/C6-650-S12	Measurement range 50 ... 650mm, analog output 4 ... 20mA, 1 teachable push/pull output, laser class 2	50113583
ODSL 9/V6-650-S12	Measurement range 50 ... 650mm, analog output 1 ... 10V, 1 teachable push/pull output, laser class 2	50114627
ODSL 9/D36-650-S12	Measurement range 50 ... 650mm, RS 485 serial connection, 1 push/pull output, laser class 2	50120000
ODSL 9/L-650-S12	Measurement range 50 ... 650mm, IO-Link interface, laser class 2	50120825
ODSL 9 with laser transmitter, measurement range 50 ... 450mm		
ODSL 9/C6-450-S12	Measurement range 50 ... 450mm, analog output 4 ... 20mA, 1 teachable push/pull output, laser class 2	50111157
ODSL 9/C6.C1-450-S12	Measurement range 50 ... 450mm, analog output 4 ... 20mA, 1 teachable push/pull output, laser class 1	50115029
ODSL 9/V6-450-S12	Measurement range 50 ... 450mm, analog output 1 ... 10V, 1 teachable push/pull output, laser class 2	50111158
ODSL 9/V6.C1-450-S12	Measurement range 50 ... 450mm, analog output 1 ... 10V, 1 teachable push/pull output, laser class 1	50115030
ODSL 9/L-450-S12	Measurement range 50 ... 450mm, IO-Link interface, laser class 2	50111166
ODSL 9/D26-450-S12	Measurement range 50 ... 450mm, RS 232 serial connection, 1 push/pull output, laser class 2	50111159
ODSL 9/D36-450-S12	Measurement range 50 ... 450mm, RS 485 serial connection, 1 push/pull output, laser class 2	50111160
ODSL 9/C66-450-S12	Measurement range 50 ... 450mm, analog output 4 ... 20mA, 2 push/pull outputs, laser class 2	50111161
ODSL 9/V66-450-S12	Measurement range 50 ... 450mm, analog output 1 ... 10V, 2 push/pull outputs, laser class 2	50111162
ODSL 9/66-450-S12	Measurement range 50 ... 450mm, 2 teachable push/pull outputs, laser class 2	50111163
ODSL 9 with laser transmitter, measurement range 50 ... 200mm		
ODSL 9/C6-200-S12	Measurement range 50 ... 200mm, analog output 4 ... 20mA, 1 teachable push/pull output, laser class 2	50117334
ODSL 9/V6-200-S12	Measurement range 50 ... 200mm, analog output 1 ... 10V, 1 teachable push/pull output, laser class 2	50113332

Tabelle 11.1: ODSL 9 type overview

Type designation	Description	Part no.
ODSL 9 with laser transmitter, measurement range 50 ... 100mm		
ODSL 9/C6-100-S12	Measurement range 50 ... 100mm, analog output 4 ... 20mA, 1 teachable push/pull output, laser class 2	50111167
ODSL 9/V6-100-S12	Measurement range 50 ... 100mm, analog output 1 ... 10V, 1 teachable push/pull output, laser class 2	50111168
ODSL 9/L-100-S12	Measurement range 50 ... 100mm, IO-Link interface, laser class 2	50111174
ODSL 9/D26-100-S12	Measurement range 50 ... 100mm, RS 232 serial connection, 1 push/pull output, laser class 2	50111169
ODSL 9/D36-100-S12	Measurement range 50 ... 100mm, RS 485 serial connection, 1 push/pull output, laser class 2	50111170
ODSL 9/C66-100-S12	Measurement range 50 ... 100mm, analog output 4 ... 20mA, 2 push/pull outputs, laser class 2	50111171
ODSL 9/V66-100-S12	Measurement range 50 ... 100mm, analog output 1 ... 10V, 2 push/pull outputs, laser class 2	50111172
ODSL 9/66-100-S12	Measurement range 50 ... 100mm, 2 teachable push/pull outputs, laser class 2	50111173

Tabelle 11.1: ODSL 9 type overview

11.2 ODS... 96B/ODK... 96B type overview

11.2.1 Triangulation sensors

Type designation	Description	Part no.
ODSL 96B with laser transmitter, measurement range 150 ... 2000mm		
ODSL 96B M/C6-2000-S12	Measurement range 150 ... 2000mm, analog output 4 ... 20mA, 1 teachable push/pull output, laser class 2	50106593
ODSL 96B M/V6-2000-S12	Measurement range 150 ... 2000mm, analog output 1 ... 10V, 1 teachable push/pull output, laser class 2	50106594
ODSL 96B M/L-2000-S12	Measurement range 150 ... 2000mm, IO-Link interface, laser class 2	50111164
ODSL 96B M/D26-2000-S12	Measurement range 150 ... 2000mm, RS 232 serial connection, 1 push/pull output, laser class 2	50106597
ODSL 96B M/D36-2000-S12	Measurement range 150 ... 2000mm, RS 485 serial connection, 1 push/pull output, laser class 2	50106598
ODSL 96B M/66-2000-S12	Measurement range 150 ... 2000mm, 2 teachable push/pull outputs, laser class 2	50106599
ODSLR 96B with red-light laser LED, measurement range 60 ... 2000mm		
ODSLR 96B M/C6-2000-S12	Measurement range 60 ... 2000mm, analog output 4 ... 20mA, 1 teachable push/pull output, laser class 2	50106732
ODSLR 96B M/V6-2000-S12	Measurement range 60 ... 2000mm, analog output 1 ... 10V, 1 teachable push/pull output, laser class 2	50106733
ODSL 96B with laser transmitter, "XL" light spot, measurement range 150 ... 1200mm		
ODSL 96B M/C6.XL-1200-S12	Measurement range 150 ... 1200mm, analog output 4 ... 20mA, Light spot: 15mm x 4mm, 1 teachable push/pull output, laser class 2	50106736
ODSL 96B M/V6.XL-1200-S12	Measurement range 150 ... 1200mm, analog output 1 ... 10V, Light spot: 15mm x 4mm, 1 teachable push/pull output, laser class 2	50106737
ODSL 96B with laser transmitter, "S" light spot, measurement range 150 ... 800mm / 150 ... 1500mm		
ODSL 96B M/C6.S-800-S12	Measurement range 150 ... 800mm, analog output 4 ... 20mA, Light spot diameter: abt. 1 mm, 1 teachable push/pull output, laser class 2	50106728
ODSL 96B M/V6.S-800-S12	Measurement range 150 ... 800mm, analog output 1 ... 10V, Light spot diameter: abt. 1 mm, 1 teachable push/pull output, laser class 2	50106729
ODSL 96B M/D26.S-800-S12	Measurement range 150 ... 800mm, RS 232 serial connection, Light spot diameter: abt. 1 mm, 1 teachable push/pull output, laser class 2	50111035
ODSL 96B M/D36.S-800-S12	Measurement range 150 ... 800mm, RS 485 serial connection, Light spot diameter: abt. 1 mm, 1 teachable push/pull output, laser class 2	50112065
ODSL 96B M/C6.C1S-1500-S12	Measurement range 150 ... 1500mm, analog output 4 ... 20mA, Light spot diameter: abt. 1 mm, 1 teachable push/pull output, laser class 1	50123687
ODSL 96B M/V6.C1S-1500-S12	Measurement range 150 ... 1500mm, analog output 1 ... 10V, Light spot diameter: abt. 1 mm, 1 teachable push/pull output, laser class 1	50123686

Tabelle 11.2: Type overview triangulation sensors ODS... 96B

Type designation	Description	Part no.
ODS 96B with infrared LED		
ODS 96B M/C66.01-1400-S12	Measurement range 120 ... 1400mm, analog output 4 ... 20mA, 2 push/pull warning outputs	50106727
ODS 96B M/V6-1400-S12	Measurement range 120 ... 1400mm, analog output 1 ... 10V, 1 teachable push/pull output	50110231
ODS 96B M/C-600-S12	Measurement range 100 ... 600mm, analog output 4 ... 20mA, 1 teachable push/pull output	50106720
ODS 96B M/V-600-S12	Measurement range 100 ... 600mm, analog output 1 ... 10V, 1 teachable push/pull output	50106721
ODS 96B M/D26-600-S12	Measurement range 100 ... 600mm, RS 232 serial connection, 1 push/pull output	50106722
ODS 96B M/D36-600-S12	Measurement range 100 ... 600mm, RS 485 serial connection, 1 push/pull output	50106723
ODS 96B M/66-600-S12	Measurement range 100 ... 600mm, 2 teachable push/pull outputs	50106724
ODS 96B with red-light LED		
ODSR 96B M/C-600-S12	Measurement range 100 ... 600mm, analog output 4 ... 20mA, 1 teachable push/pull output	50106730s
ODSR 96B M/V-600-S12	Measurement range 100 ... 600mm, analog output 1 ... 10V, 1 teachable push/pull output	50106731

Tabelle 11.2: Type overview triangulation sensors ODS... 96B

11.2.2 Time-of-flight sensors **JLTOF**

Type designation	Description	Part no.
ODKL 96B with red-light laser transmitter, measurement range 300 ... 25,000mm Measurement against high-gain reflective tape		
ODKL 96B M/C6-S12	Measurement range 300 ... 25000mm, analog output 4 ... 20mA, 1 teachable push/pull output, laser class 2	50109297
ODKL 96B M/V6-S12	Measurement range 300 ... 25000mm, analog output 1 ... 10V, 1 teachable push/pull output, laser class 2	50109298
ODKL 96B M/L-S12	Measurement range 300 ... 25000mm, IO-Link interface, laser class 2	50109301
ODKL 96B M/D26-S12	Measurement range 300 ... 25000mm, RS 232 serial connection, 1 push/pull output, laser class 2	50109299
ODKL 96B M/D36-S12	Measurement range 300 ... 25000mm, RS 485 serial connection, 1 push/pull output, laser class 2	50109300
REF 7-A-100x100	High-gain reflective tape for ODKL 96B, cut 100 mm x 100 mm	50111527
ODSIL 96B with infrared laser transmitter / red-light alignment laser, measurement range 300 ... 10,000mm Measurement against diffusely reflective objects		
ODSIL 96B M/C6-S12	Measurement range 300 ... 10,000mm, analog output 4 ... 20mA, 1 teachable push/pull output, laser class 1	50109302
ODSIL 96B M/V6-S12	Measurement range 300 ... 10,000mm, analog output 1 ... 10V, 1 teachable push/pull output, laser class 1	50109303
ODSL 96B with red-light laser transmitter, measurement range 300 ... 10000mm Measurement against diffusely reflective objects		
ODSL 96B M/C6-S12	Measurement range 300 ... 10000mm, analog output 4 ... 20mA, 1 teachable push/pull output, laser class 2	50109290
ODSL 96B M/V6-S12	Measurement range 300 ... 10000mm, analog output 1 ... 10V, 1 teachable push/pull output, laser class 2	50109291
ODSL 96B M/D26-S12	Measurement range 300 ... 10000mm, RS 232 serial connection, 1 push/pull output, laser class 2	50109292
ODSL 96B M/D36-S12	Measurement range 300 ... 10000mm, RS 485 serial connection, 1 push/pull output, laser class 2	50109293
ODSL 96B M/C66-S12	Measurement range 300 ... 10000mm, analog output 4 ... 20mA, 2 push/pull outputs, laser class 2	50109295

Tabelle 11.3: Type overview time-of-flight sensors OD...L 96B

11.3 Accessory connection cables and connectors for ODSL 9/OD...96B

Designation	Order no.	Short descriptions
KD 095-5	50020502	M 12 connector (cable socket), user-configurable, 5-pin, angular
KD 095-5A	50020501	M 12 connector (cable socket), user-configurable, 5-pin, axial
K-D M12W-5P-2m-PVC	50104556	PVC connection cable with cable socket on one end, 5-pin, M 12, angular, 2m
K-D M12A-5P-2m-PVC	50104555	PVC connection cable with cable socket on one end, 5-pin, M 12, axial, 2m
K-D M12W-5P-5m-PVC	50104558	PVC connection cable with cable socket on one end, 5-pin, M 12, angular, 5m
K-D M12A-5P-5m-PVC	50104557	PVC connection cable with cable socket on one end, 5-pin, M 12, axial, 5m
K-D M12W-5P-10m-PVC	50104560	PVC connection cable with cable socket on one end, 5-pin, M 12, angular, 10m
K-D M12A-5P-10m-PVC	50104559	PVC connection cable with cable socket on one end, 5-pin, M 12, axial, 10m
K-D M12W-5P-2m-PUR	50104568	PUR connection cable with cable socket on one end, 5-pin, M 12, angular, 2m
K-D M12A-5P-2m-PUR	50104567	PUR connection cable with cable socket on one end, 5-pin, M 12, axial, 2m
K-D M12W-5P-5m-PUR	50104762	PUR connection cable with cable socket on one end, 5-pin, M 12, angular, 5m
K-D M12A-5P-5m-PUR	50104569	PUR connection cable with cable socket on one end, 5-pin, M 12, axial, 5m

Tabelle 11.4: Accessory connection cables and connectors

11.4 Accessory mounting systems for ODSL 9/OD... 96B

Designation	Order no.	Short descriptions
Mounting systems for ODSL 9		
BT 8	50036195	Mounting bracket
BT 300M.5	50118543	Mounting bracket, stainless steel
BTP 300M - D10	50117827	Sensor protective cover for rod Ø 10mm
BTP 300M - D12	50117826	Sensor protective cover for rod Ø 12mm
BTP 300M - D14	50117825	Sensor protective cover for rod Ø 14mm
BTU 300M - D10	50117253	Sensor mounting bracket for rod Ø 10mm
BTU 300M - D12	50117252	Sensor mounting bracket for rod Ø 12mm
BTU 300M - D14	50117251	Sensor mounting bracket for rod Ø 14mm
Mounting systems for ODS... 96B / ODKL 96B		
BT 450.1-96	50082084	Sensor mounting bracket for rod Ø 10mm
BT 450.3-96	50104897	Sensor mounting bracket for rod Ø 12mm
BT 96	50025570	Mounting bracket
BT 96.1	50080614	Mounting bracket
BT 96.4	50032319	Mounting bracket
UMS 96	50026204	Universal mounting system for rod Ø 10/12/14mm
BT 56	50027375	Mounting device with dovetail for rod Ø 16/18/20mm
BT 59	50111224	Mounting device with dovetail for ITEM MB System

Tabelle 11.5: Accessory mounting systems

11.5 Additional accessories for ODSL 9/OD... 96B

Designation	Order no.	Short descriptions
PC configuration accessories		
UPG 10	50107223	Universal configuration adapter (not for IO-Link sensors)
ODS configuration software	Free download from www.leuze.com	Software for convenient PC configuration of the ODSL 9, ODS... 96B, ODKL 96B (not for IO-Link sensors)
Accessories for distance sensors with IO-Link interface		
SET MD12-US2-IL1.1 + accessories.	50121098	IO-Link master set, for sensors with IO-Link interface (V1.0.1 or V1.1)
K-DS M12A-M12A-4P-2m-PVC	50110126	Connection cable, distance sensor to IO-Link master
IODD	Free download from www.leuze.com	IO-Link Device Description
Accessories for fieldbus connection of distance sensors with RS 232 interface		
MA 204i	50112893	Modular fieldbus connection for field use, interfaces: RS232 / PROFIBUS DP
MA 208i	50112892	Modular fieldbus connection for field use, interfaces: RS232 / Ethernet TCP/IP
MA 235i	50114154	Modular fieldbus connection for field use, interfaces: RS232 / CANopen
MA 238i	50114155	Modular fieldbus connection for field use, interfaces: RS232 / EtherCAT
MA 248i	50112891	Modular fieldbus connection for field use, interfaces: RS232 / PROFINET-IO
MA 255i	50114156	Modular fieldbus connection for field use, interfaces: RS232 / DeviceNet
MA 258i	50114157	Modular fieldbus connection for field use, interfaces: RS232 / Ethernet/IP
K-DS M12A-MA-5P-3m-S-PUR	50111224	Connection cable for ODSL 9/OD... 96B with RS232 to modular interfacing units MA 2xxi, cable length 3 m

Tabelle 11.6: Accessories for PC configuration / IO-Link / fieldbus connection