

BCL358i
Bar code reader



Sales and Service

Germany

Sales Region North

Phone 07021/573-306
Tel. Int. + 34 93 4097900
Fax 07021/9850950

Postal code areas
20000-38999
40000-65999
97000-97999

Sales Region South

Phone 07021/573-307
Tel. Int. + 34 93 94935820

Postal code areas
66000-96999

Sales Region East

Phone 035027/629-106
Fax 035027/629-107

Postal code areas
01000-19999
39000-39999
98000-99999

Worldwide

AR (Argentina)

Condelectric S.A.
Tel. Int. + 54 1148 361053
Fax Int. + 54 1148 361053

AT (Austria)

Schmachtl GmbH
Tel. Int. + 43 732 7646-0
Fax Int. + 43 732 7646-785

AU + NZ (Australia + New Zealand)

Balluff/Leuze Pty. Ltd.
Tel. Int. + 61 3 9720 4100
Fax Int. + 61 3 9738 2677

BE (Belgium)

Leuze electronic nv/sa
Tel. Int. + 32 2253 16-00
Fax Int. + 32 2253 15-36

BG (Bulgaria)

ATICS
Tel. Int. + 359 2 847 6244
Fax Int. + 359 2 847 6244

BR (Brazil)

Leuze electronic Ltda.
Tel. Int. + 55 11 5180-6130
Fax Int. + 55 11 5180-6141

CH (Switzerland)

Leuze electronic AG
Tel. Int. + 41 41 784 5656
Fax Int. + 41 41 784 5657

CL (Chile)

Imp. Tec. Vignola S.A.I.C.
Tel. Int. + 56 3235 11-11
Fax Int. + 56 3235 11-28

CN (China)

Leuze electronic Trading
(Shenzhen) Co. Ltd.
Tel. Int. + 86 755 862 64909
Fax Int. + 86 755 862 64901

CO (Colombia)

Componentes Electronicas Ltda.
Tel. Int. + 57 4 3511049
Fax Int. + 57 4 3511019

CZ (Czech Republic)

Schmachtl CZ s.r.o.
Tel. Int. + 420 244 0015-00
Fax Int. + 420 244 9107-00

DK (Denmark)

Leuze electronic Scandinavia ApS
Tel. Int. + 45 48 173200

ES (Spain)

Leuze electronic S.A.
Tel. Int. + 34 93 4097900
Fax Int. + 34 93 94935820

FI (Finland)

SKS-automatio Oy
Tel. Int. + 358 20 764-61
Fax Int. + 358 20 764-6820

FR (France)

Leuze electronic Sarl.
Tel. Int. + 33 160 0512-20
Fax Int. + 33 160 0503-65

GB (United Kingdom)

Leuze electronic Ltd.
Tel. Int. + 44 14 8040 85-00
Fax Int. + 44 14 8040 38-08

GR (Greece)

UTECO A.B.E.E.
Tel. Int. + 30 211 1206 900
Fax Int. + 30 211 1206 999

HK (Hong Kong)

Sensortech Company
Tel. Int. + 852 26510188
Fax Int. + 852 26510388

HR (Croatia)

Tipteh Zagreb d.o.o.
Tel. Int. + 385 1 381 6574
Fax Int. + 385 1 381 6577

HU (Hungary)

Kvaik Automatika Kft.
Tel. Int. + 36 1 272 2242
Fax Int. + 36 1 272 2244

ID (Indonesia)

P.T. Jabestindo Mitra Utama
Tel. Int. + 62 21 92861859
Fax Int. + 62 21 6451044

IL (Israel)

Galoz electronics Ltd.
Tel. Int. + 972 3 9023456
Fax Int. + 972 3 9021990

IN (India)

M + V Marketing Sales Pvt Ltd.
Tel. Int. + 91 124 4121623
Fax Int. + 91 124 434223

IT (Italy)

Leuze electronic S.r.l.
Tel. Int. + 39 02 26 1106-43
Fax Int. + 39 02 26 1106-40

JP (Japan)

C. Illies & Co., Ltd.
Tel. Int. + 81 3 3443 4143
Fax Int. + 81 3 3443 4118

KE (Kenia)

Profa-Tech Ltd.
Tel. Int. + 254 20 828095/6
Fax Int. + 254 20 828129

KR (South Korea)

Leuze electronic Co., Ltd.
Tel. Int. + 82 31 3828228
Fax Int. + 82 31 3828522

MK (Macedonia)

Tipteh d.o.o. Skopje
Tel. Int. + 389 70 399 474
Fax Int. + 389 23 174 197

MX (Mexico)

Movitren S.A.
Tel. Int. + 52 81 8371 8616
Fax Int. + 52 81 8371 8588

MY (Malaysia)

Ingermark (M) SDN.BHD
Tel. Int. + 60 360 3427-88
Fax Int. + 60 360 3421-88

NG (Nigeria)

SABROW HI-TECH E. & A. LTD.
Tel. Int. + 234 80333 86366
Fax Int. + 234 80333 84463518

NL (Netherlands)

Leuze electronic BV
Tel. Int. + 31 418 65 35-44
Fax Int. + 31 418 65 38-08

NO (Norway)

Elteco A/S
Tel. Int. + 47 35 56 20-70
Fax Int. + 47 35 56 20-99

PL (Poland)

Balluff Sp. z o. o.
Tel. Int. + 48 71 338 49 29
Fax Int. + 48 71 338 49 30

PT (Portugal)

LA2P, Lda.
Tel. Int. + 351 21 4 447070
Fax Int. + 351 21 4 447075

RO (Romania)

O BOYLE s.r.l.
Tel. Int. + 40 2 56201346
Fax Int. + 40 2 56221036

RS (Republic of Serbia)

Tipteh d.o.o. Beograd
Tel. Int. + 381 11 3131 057
Fax Int. + 381 11 3131 326

RU (Russian Federation)

ALL IMPEX 2001
Tel. Int. + 7 495 9213012
Fax Int. + 7 495 6462092

SE (Sweden)

Leuze electronic Scandinavia ApS
Tel. Int. +46 380-490951

SG + PH (Singapore + Philippines)

Balluff Asia Pte Ltd
Tel. Int. + 65 6252 43-84
Fax Int. + 65 6252 90-60

SI (Slovenia)

Tipteh d.o.o.
Tel. Int. + 386 1200 51-50
Fax Int. + 386 1200 51-51

SK (Slovakia)

Schmachtl SK s.r.o.
Tel. Int. + 421 2 58275600
Fax Int. + 421 2 58275601

TH (Thailand)

Industrial Electrical Co. Ltd.
Tel. Int. + 66 2 642 6700
Fax Int. + 66 2 642 4250

TR (Turkey)

Leuze electronic San ve Tic.Ltd.Siti.
Tel. Int. + 90 216 456 6704
Fax Int. + 90 216 456 3650

TW (Taiwan)

Great Colvue Technology Co., Ltd.
Tel. Int. + 886 2 2983 80-77
Fax Int. + 886 2 2985 33-73

UA (Ukraine)

SV Altera OOO
Tel. Int. + 38 044 4961888
Fax Int. + 38 044 4961818

US + CA (United States + Canada)

Leuze electronic, Inc.
Tel. Int. + 1 248 486-4466
Fax Int. + 1 248 486-6699

ZA (South Africa)

Countapulse Controls (PTY).Ltd.
Tel. Int. + 27 116 1575-56
Fax Int. + 27 116 1575-13

1	General information.....	9
1.1	Explanation of symbols.....	9
1.2	Declaration of conformity	9
2	Safety notices	10
2.1	General safety notices.....	10
2.2	Safety standards	10
2.3	Approved purpose	10
2.4	Working safely	11
3	Fast commissioning / operating principle.....	14
3.1	Mounting the BCL 358 <i>i</i>	14
3.2	Device arrangement and selection of the mounting location.....	14
3.3	Electrical connection BCL 358 <i>i</i>	15
3.4	Preparatory EtherNet/IP settings.....	17
3.4.1	BCL 358 <i>i</i> on EtherNet/IP	17
3.4.2	Manually setting the IP address.....	18
3.4.3	Configure the participant.....	19
3.4.4	Transferring the data to the control (RSLogix 5000 specific).....	20
3.5	Further settings.....	20
3.6	Starting the device	21
3.7	Bar code reading.....	23
4	Device description	24
4.1	About the bar code readers of the BCL 300 <i>i</i> series.....	24
4.2	Characteristics of the bar code readers of the BCL 300 <i>i</i> series.....	25
4.3	Device construction.....	27
4.4	Reading techniques.....	30
4.4.1	Line scanner (single line).....	30
4.4.2	Line scanner with oscillating mirror.....	31
4.4.3	Raster scanner (raster line)	32
4.5	Fieldbus systems	33
4.5.1	EtherNet/IP	33
4.5.2	Ethernet – star topology.....	34
4.5.3	Ethernet – linear topology.....	35
4.6	Heater	35

4.7	autoReflAct	36
4.8	Reference codes	36
4.9	autoConfig	37
5	Specifications	38
5.1	General specifications of the bar code readers	38
5.1.1	Line scanner / raster scanner.....	38
5.1.2	Oscillating-mirror scanner	40
5.1.3	Line scanner / raster scanner with deflection mirror.....	40
5.2	Heating models of the bar code readers	41
5.2.1	Line scanner / raster scanner with heater	42
5.2.2	Oscillating-mirror scanner with heating	42
5.2.3	Line scanner / raster scanner with deflection mirror and heating.....	43
5.3	Dimensioned drawings	44
5.3.1	Dimensioned drawing of complete overview of the BCL 358 <i>i</i> with MS 3xx / MK 3xx.....	44
5.3.2	Dimensioned drawing of line scanner with / without heating.....	45
5.3.3	Dimensioned drawing of deflection mirror scanner with / without heating.....	46
5.3.4	Dimensioned drawing of oscillating-mirror scanner with / without heating	47
5.3.5	Dimensioned drawing of MS 3xx connector hood / MK 3xx terminal hood	48
5.4	Reading field curves / optical data	49
5.4.1	Bar code characteristics	49
5.4.2	Raster scanner	50
5.5	Reading field curves	51
5.5.1	High Density (N) - optics: BCL 358 <i>i</i> S/R1 N 102 (H).....	52
5.5.2	High Density (N) - optics: BCL 358 <i>i</i> S/R1 N 100 (H).....	52
5.5.3	Medium Density (M) - optics: BCL 358 <i>i</i> S/R1 M 102 (H).....	53
5.5.4	Medium Density (M) - optics: BCL 358 <i>i</i> S/R1 M 100 (H).....	53
5.5.5	Medium Density (M) - optics: BCL 358 <i>i</i> OM 100 (H).....	54
5.5.6	Low Density (F) - optics: BCL 358 <i>i</i> S/R1 F 102 (H)	55
5.5.7	Low Density (F) - optics: BCL 358 <i>i</i> S/R1 F 100 (H)	55
5.5.8	Low Density (F) - optics: BCL 358 <i>i</i> OF 100 (H).....	56
5.5.9	Ultra Low Density (L) - optics: BCL 358 <i>i</i> S L 102 (H).....	57
5.5.10	Ultra Low Density (L) - optics: BCL 358 <i>i</i> S L 100 (H).....	57
5.5.11	Ultra Low Density (L) - optics: BCL 358 <i>i</i> OL 100 (H)	58
6	Installation and mounting	59
6.1	Storage, transportation	59
6.2	Mounting the BCL 358<i>i</i>	60
6.2.1	Fastening with M4 x 5 screws	60
6.2.2	BT 56 mounting device	61
6.2.3	BT 59 mounting device	63

6.3	Device arrangement.....	64
6.3.1	Selecting a mounting location	64
6.3.2	Avoiding total reflection – line scanner	65
6.3.3	Avoiding total reflection – deflection mirror scanner	65
6.3.4	Avoiding total reflection – oscillating-mirror scanner	66
6.3.5	Mounting location.....	66
6.3.6	Devices with integrated heating.....	67
6.3.7	Possible reading angles between BCL 358 <i>i</i> and bar code	67
6.4	Cleaning.....	68
7	Electrical connection.....	69
7.1	Safety notices for the electrical connection.....	70
7.2	Electrical connection BCL 358<i>i</i>	71
7.2.1	MS 358 connector hood with 3 integrated M12 connectors.....	71
7.2.2	MK 358 terminal hood with spring-loaded terminals.....	72
7.3	Detailed description of the connections.....	74
7.3.1	PWR / SW IN/OUT - Voltage supply and switching input/outputs 1 and 2	74
7.3.2	SERVICE – USB interface (Mini-B type)	77
7.3.3	HOST / BUS IN for BCL 358 <i>i</i>	78
7.3.4	BUS OUT for the BCL 358 <i>i</i>	79
7.4	Ethernet topologies	80
7.4.1	Ethernet wiring.....	81
7.5	Cable lengths and shielding	82
8	Display elements and display.....	83
8.1	LED indicators BCL 358<i>i</i>	83
8.2	MS 358/MK 358 LED indicators.....	85
8.3	Display BCL 358<i>i</i>.....	86
9	Leuze webConfig tool.....	88
9.1	Connecting the SERVICE USB interface.....	88
9.2	Installing the required software.....	89
9.2.1	System requirements.....	89
9.2.2	Installing the USB driver	89
9.3	Starting the webConfig tool	90
9.4	Short description of the webConfig tool.....	91
9.4.1	Module overview in the Configuration menu.....	91

10	Commissioning and configuration	93
10.1	Measures to be performed prior to the initial commissioning	93
10.2	Starting the device.....	94
10.3	Setting the communication parameters	94
10.3.1	Manually setting the IP address	95
10.4	Configuration steps for a Rockwell control without EDS support.....	96
10.4.1	Integrating the hardware into the PLC using the generic Ethernet module.....	96
10.5	Configuration steps for a Rockwell control with EDS support	97
10.5.1	Integrating the hardware into the PLC and installing the EDS file.....	97
10.6	EDS file - general info.....	98
10.7	Detailed EDS description	99
10.7.1	Class 1 - Identity object.....	99
10.7.2	Class 4 - Assembly	101
10.7.3	Class 103 - I/O status and control.....	108
10.7.4	Class 106 - Activation	110
10.7.5	Class 107 - Result data.....	112
10.7.6	Class 108 - Entry data.....	114
10.7.7	Class 109 - Device status and device control	117
10.8	Configuration example	118
10.8.1	Example 1 - activation & result.....	119
10.8.2	Example 2 - activation & result & I/Os.....	122
10.8.3	Example 3 - activation & fragmented result.....	125
10.8.4	Example 4 - entry data & result.....	128
10.9	Additional settings for the BCL 358/.....	131
10.9.1	Decoding and processing the read data	131
10.9.2	Control of the decoding.....	133
10.9.3	Control of the switching outputs	134
10.10	Transmitting configuration data.....	135
10.10.1	Via the webConfig tool	135
10.10.2	Replacing a defective BCL 358/.....	135
11	Online commands.....	136
11.1	Overview of commands and parameters.....	136
11.1.1	General 'online' commands.....	137
11.1.2	'Online' commands for system control	144
11.1.3	'Online' commands for configuration of switching inputs/outputs.....	145
11.1.4	'Online' commands for the parameter set operations.....	148

12	Diagnostics and troubleshooting.....	155
12.1	General causes of errors.....	155
12.2	Interface errors.....	155
13	Type overview and accessories	157
13.1	Part number code	157
13.2	Type overview BCL 358 <i>i</i>	158
13.3	Accessory connection hoods	159
13.4	Accessory connectors	159
13.5	Accessory USB cable.....	159
13.6	Accessory mounting device	159
13.7	Reflector accessories for autoRefIAct.....	159
13.8	Accessory ready-made cables for voltage supply.....	160
13.8.1	Contact assignment of PWR connection cable.....	160
13.8.2	Specifications of the cables for voltage supply	160
13.8.3	Order codes of the cables for voltage supply	160
13.9	Accessory ready-made cables for bus connection	160
13.9.1	General information	160
13.9.2	Contact assignments M12 EtherNet/IP connection cables KB ET... ..	161
13.9.3	Specifications of the M12 EtherNet/IP connection cables KB ET... ..	161
13.9.4	Order codes for M12 EtherNet/IP connection cables KB ET... ..	162
14	Maintenance	163
14.1	General maintenance information.....	163
14.2	Repairs, servicing	163
14.3	Disassembling, packing, disposing	163
15	Appendix	164
15.1	Declaration of Conformity	164
15.2	ASCII character set	166
15.3	Bar code samples	170
15.3.1	Module 0.3	170
15.3.2	Module 0.5	171

Figure 2.1:	Attachment of the stick-on labels with warning notices at the BCL 358 <i>i</i>	13
Figure 3.1:	BCL 358 <i>i</i> - MS 358 connector hood with M12 connectors	15
Figure 3.2:	BCL 358 <i>i</i> - MK 358 terminal hood with spring-loaded terminals.....	16
Figure 3.3:	Cable fabrication for MK 358 terminal hood	16
Figure 4.1:	Line scanner, line scanner with deflection mirror and oscillating-mirror scanner	24
Figure 4.2:	Possible bar code orientation	26
Figure 4.3:	BCL 358 <i>i</i> device construction - line scanner	27
Figure 4.4:	BCL 358 <i>i</i> device construction - line scanner with deflection mirror	27
Figure 4.5:	BCL 358 <i>i</i> device construction - oscillating-mirror scanner.....	28
Figure 4.6:	Device construction MS 358 connector hood	29
Figure 4.7:	Device construction MK 358 terminal hood	29
Figure 4.8:	Deflection principle for the line scanner.....	30
Figure 4.9:	Deflection principle for the line scanner with oscillating mirror add-on.....	31
Figure 4.10:	Deflection principle for the raster scanner	32
Figure 4.11:	Ethernet with star topology	34
Figure 4.12:	Ethernet with linear topology	35
Figure 4.13:	Reflector arrangement for autoReflAct	36
Table 5.1:	Specifications of the BCL 358 <i>i</i> line/raster scanners without heating.....	38
Table 5.2:	Specifications of the BCL 358 <i>i</i> oscillating-mirror scanners without heating	40
Table 5.3:	Specifications of the BCL 358 <i>i</i> deflection mirror scanners without heating.....	40
Table 5.4:	Specifications of the BCL 358 <i>i</i> line/raster scanners with heating.....	42
Table 5.5:	Specifications of the BCL 358 <i>i</i> oscillating-mirror scanners with heating	42
Table 5.6:	Specifications of the BCL 358 <i>i</i> deflection mirror scanners with heating.....	43
Figure 5.1:	Dimensioned drawing of complete overview of the BCL 358 <i>i</i> with MS 3xx / MK 3xx	44
Figure 5.2:	Dimensioned drawing BCL 358 <i>i</i> line scanner S...102.....	45
Figure 5.3:	Dimensioned drawing BCL 358 <i>i</i> deflection mirror scanner S...100.....	46
Figure 5.4:	Dimensioned drawing BCL 358 <i>i</i> oscillating mirror scanner O...100.....	47
Figure 5.5:	Dimensioned drawing of MS 3xx connector hood / MK 3xx terminal hood.....	48
Figure 5.6:	The most important characteristics of a bar code.....	49
Table 5.7:	Raster line cover as a function of the distance.....	50
Figure 5.7:	Zero position of the reading distance.....	51
Table 5.8:	Reading conditions	51
Figure 5.8:	"High Density" reading field curve for line scanner without deflection mirror.....	52
Figure 5.9:	"High Density" reading field curve for line scanner with deflection mirror.....	52
Figure 5.10:	"Medium Density" reading field curve for line scanner without deflection mirror	53
Figure 5.11:	"Medium Density" reading field curve for line scanner with deflection mirror	53
Figure 5.12:	"Medium Density" reading field curve for oscillating-mirror scanners.....	54
Figure 5.13:	Lateral "Medium Density" reading field curve for oscillating-mirror scanners.....	54
Figure 5.14:	"Low Density" reading field curve for line scanner without deflection mirror	55
Figure 5.15:	"Low Density" reading field curve for line scanner with deflection mirror	55
Figure 5.16:	"Low Density" reading field curve for oscillating-mirror scanners	56
Figure 5.17:	Lateral "Low Density" reading field curve for oscillating-mirror scanners	56
Figure 5.18:	"Ultra Low Density" reading field curve for line scanner without deflection mirror.....	57

Figure 5.19:	"Ultra Low Density" reading field curve for line scanner with deflection mirror	57
Figure 5.20:	"Ultra Low Density" reading field curve for oscillating-mirror scanners.....	58
Figure 5.21:	Lateral "Ultra Low Density" reading field curve for oscillating-mirror scanners.....	58
Figure 6.1:	Device name plate BCL 358 <i>i</i>	59
Figure 6.2:	Fastening options using M4x5 threaded holes	60
Figure 6.3:	BT 56 mounting device	61
Figure 6.4:	Mounting example of BCL 358 <i>i</i> with BT 56.....	62
Figure 6.5:	BT 59 mounting device	63
Figure 6.6:	Total reflection – line scanner	65
Figure 6.7:	Total reflection – line scanner	65
Figure 6.8:	Total reflection – BCL 358 <i>i</i> with oscillating mirror	66
Figure 6.9:	Reading angle for the line scanner	67
Figure 7.1:	Location of the electrical connections	69
Figure 7.2:	BCL 358 <i>i</i> - MS 358 connector hood with M12 connectors.....	71
Figure 7.3:	BCL 358 <i>i</i> - MK 358 terminal hood with spring-loaded terminals.....	72
Figure 7.4:	Cable fabrication for MK 358 terminal hood.....	73
Table 7.1:	Pin assignment PWR / SW IN/OUT	74
Figure 7.1:	Switching input connection diagram SWIO_1 and SWIO_2	75
Figure 7.2:	Switching output connection diagram SWIO_1 / SWIO_2	76
Table 7.2:	Pin assignment SERVICE – Mini-B type USB interface.....	77
Table 7.3:	Pin assignment HOST / BUS IN BCL 358 <i>i</i>	78
Figure 7.3:	HOST / BUS IN cable assignments on RJ-45.....	78
Table 7.4:	Pin assignment BUS OUTBCL 358 <i>i</i>	79
Figure 7.4:	Ethernet with star topology	80
Figure 7.5:	Ethernet with linear topology.....	81
Table 7.5:	Cable lengths and shielding.....	82
Figure 8.1:	BCL 358 <i>i</i> - LED indicators.....	83
Figure 8.2:	MS 358/MK 358 - LED indicators.....	85
Figure 8.3:	BCL 358 <i>i</i> - Display	86
Figure 9.1:	Connecting the SERVICE USB interface.....	88
Figure 9.2:	The start page of the webConfig tool.....	90
Figure 9.3:	Module overview in the webConfig tool.....	91
Figure 10.4:	Connection between Data acceptance/Data rejection/Error code attributes.....	115
Figure 10.5:	Configuration of example 1 - module definition with generic module.....	119
Figure 10.6:	Configuration of example 1 - module definition with the EDS file	119
Figure 10.7:	Data exchange sequence diagram - example 1.....	121
Figure 10.8:	Configuration of example 2 - module definition with generic module.....	122
Figure 10.9:	Configuration of example 2 - module definition with the EDS file	122
Figure 10.10:	Data exchange sequence diagram - example 2.....	124
Figure 10.11:	Configuration of example 3 - module definition with generic module.....	125
Figure 10.12:	Configuration of example 3 - module definition with the EDS file	125
Figure 10.13:	Data exchange sequence diagram - example 3.....	127
Figure 10.14:	Configuration of example 4 - module definition with generic module.....	128

Figure 10.15:	Configuration of example 4 - module definition with the EDS file	128
Figure 10.16:	Data exchange sequence diagram - example 4	130
Figure 10.17:	Storing configuration data in the webConfig tool	135
Table 12.1:	General causes of errors	155
Table 12.2:	Interface error	155
Table 13.2:	Type overview BCL 358 <i>i</i>	158
Table 13.3:	Connection hoods for the BCL 358 <i>i</i>	159
Table 13.4:	Connectors for the BCL 358 <i>i</i>	159
Table 13.5:	Service cable for the BCL 358 <i>i</i>	159
Table 13.6:	Mounting devices for the BCL 358 <i>i</i>	159
Table 13.7:	Reflector for autoRefIAct operation.....	159
Table 13.8:	PWR cables for the BCL 358 <i>i</i>	160
Figure 13.9:	Cable structure of EtherNet/IP connection cables.....	161
Table 13.10:	Bus connection cables for the BCL 358 <i>i</i>	162
Figure 15.1:	Declaration of conformity BCL 358 <i>i</i>	164
Figure 15.2:	Connection hood / connector unit declaration of conformity.....	165
Figure 15.3:	Bar code sample labels (module 0.3)	170
Figure 15.4:	Bar code sample labels (module 0.5)	171

1 General information

1.1 Explanation of symbols

The symbols used in this technical description are explained below.



Attention!

This symbol precedes text messages which must strictly be observed. Failure to comply with this information results in injuries to personnel or damage to the equipment.



Attention Laser!

This symbol warns of possible danger caused by hazardous laser radiation.



Notice!

This symbol indicates text passages containing important information.

1.2 Declaration of conformity

The bar code readers of the BCL 300*i* series have been developed and manufactured in accordance with the applicable European standards and directives.



Notice!

You can find the Declaration of Conformity of the devices in the appendix of the manual on page 164.

The manufacturer of the product, Leuze electronic GmbH & Co KG in D-73277 Owen, possesses a certified quality assurance system in accordance with ISO 9001.



2 Safety notices

2.1 General safety notices

Documentation

All entries in this technical description must be heeded, in particular the present chapter "Safety notices". Keep this technical description in a safe place. It should be available at all times.

Safety regulations

Observe the locally applicable regulations and the rules of the employer's liability insurance association.

Repair

Repairs must only be carried out by the manufacturer or an authorized representative.

2.2 Safety standards

The bar code readers of the BCL 300*i* series were developed, manufactured and tested in accordance with the applicable safety standards. They correspond to the state of the art.

2.3 Approved purpose



Attention!

The protection of personnel and the device cannot be guaranteed if the device is operated in a manner not corresponding to its intended use.

Bar code readers of the BCL 300*i* series are conceived as stationary, high-speed scanners with integrated decoders for all current bar codes used for automatic object detection.

In particular, unauthorized uses include:

- in rooms with explosive atmospheres
- operation for medical purposes

Areas of application

The bar code readers of the BCL 300*i* series are especially designed for the following areas of application:

- Storage technology and materials handling, in particular for object identification on fast-moving transport systems
- Pallet transport systems
- Automobile sector
- Omnidirectional reading

2.4 Working safely

**Attention!**

Access and changes to the device, except where expressly described in this operating manual, are not authorized.

Safety regulations

Observe the locally applicable legal regulations and the rules of the employer's liability insurance association.

Qualified personnel

Mounting, commissioning and maintenance of the device must only be carried out by qualified personnel.

Electrical work must be carried out by a certified electrician.

**ATTENTION, LASER RADIATION!**

*If you look into the beam path over a longer time period, the retina of your eye may be damaged! Never look directly into the beam path!
Do not point the laser beam of the BCL 358i at persons!*

When mounting and aligning the BCL 358i, avoid reflections of the laser beam off reflective surfaces! Adhere to the applicable legal and local regulations regarding protection from laser beams acc. to EN 60825 (IEC 60825) in its latest version.

CAUTION: *Use of controls or adjustments or performance of procedures other than specified herein may result in hazardous light exposure! The use of optical instruments or devices with the product will increase eye hazard!*

The glass optics cover is the only aperture through which laser radiation may be observed on this product. The device must not be tampered with and must not be changed in any way. There are no user-serviceable parts inside the device.

A failure of the scanner motor while the laser diode continues to emit a laser beam may cause the emission level limit to be exceeded. The device has safeguards to prevent this occurrence. If, however, a stationary beam is emitted, the failing bar code reader should be disconnected from the voltage supply immediately.

The BCL 358i fulfills the EN 60825-1 (IEC 60825-1) safety regulations for a product in laser class 2 as well as the U.S. 21 CFR 1040.10 regulations with deviations corresponding to Laser Notice No. 50 from June 24th, 2007.

The BCL 358i uses a laser diode with low power in the visible red light range with an emitted wavelength of approx. 655nm. The output power of the laser beam at the exit window is max. 1.8mW in accordance with EN 60825-1 (IEC 60825-1). The average laser power is less than 1mW in accordance with laser class 2 acc. to EN 60825-1 (IEC 60825-1).

Located inside the protective housing of the BCL 358i is a laser diode of laser class 3B. The laser diode can emit a maximum output power of 12mW CW (data sheet value, absolute maximum rating).

If the device is opened, there is a risk of injury to the retina. Therefore, the device must not be opened. Repairs must only be performed by Leuze electronic GmbH + Co. KG.

**Notice!**

It is important that you attach the stick-on labels supplied to the device (A in figure 2.1)! If the signs are concealed as a result of the mounting situation of the BCL 358i, attach the signs in the vicinity of the BCL 358i such that reading the signs cannot lead to looking into the laser beam!

3 Fast commissioning / operating principle

Below you will find a short description for the initial commissioning of the BCL 358*i*. Detailed explanations for all listed points can be found throughout this technical description.

3.1 Mounting the BCL 358*i*

The BCL 358*i* bar code readers can be mounted in two different ways:

- Via four M4x6 screws on the bottom of the device.
- Via a BT 56 mounting device in the fastening groove on the bottom of the housing.

3.2 Device arrangement and selection of the mounting location

In order to select the right mounting location, several factors must be considered:

- Size, orientation, and position tolerance of the bar codes on the objects to be scanned.
- The reading field of the BCL 358*i* in relation to the bar code module width.
- The resulting minimum and maximum reading distance from the respective reading field.
- The permissible cable lengths between the BCL 358*i* and the host system depending on which interface is used.
- The correct time for data output. The BCL 358*i* should be positioned in such a way that, taking into consideration the time required for data processing and the conveyor belt speed, there is sufficient time to e.g. initiate sorting operations on the basis of the read data.
- The display and control panel should be very visible and accessible.
- For configuring and commissioning with the webConfig tool, the USB interface should be easily accessible.

For specific information, please refer to chapter 6 and chapter 7.



Notice!

*The beam exits the BCL 358*i* as follows for the respective devices:*

- line scanner **parallel** to the **housing base**
- deflection mirror **105 degrees** to the **housing base**
- oscillating mirror **perpendicular** to the **housing base**.

The black areas in figure 6.2 are the housing base. The best read results are obtained when:

- The BCL 358*i* is mounted in such a way that the scanning beam is incident on the bar code at an angle of inclination greater than $\pm 10^\circ$... 15° to vertical.
- The reading distance lies in the middle area of the reading field.
- *The bar code labels are of good print quality and have good contrast ratios.*
- You do not use high-gloss labels.
- *There is no direct sunlight.*

3.3 Electrical connection BCL 358*i*

For the electrical connection of the BCL 358*i*, 2 connection variants are available.

The **voltage supply** (18 ... 30VDC) is connected acc. to the connection type selected.

2 freely programmable switching inputs/outputs for individual adaptation to the respective application are also available here. Detailed information on this topic can be found in chapter 7.3.3.

MS 358 hood with 2 integrated M12 connectors

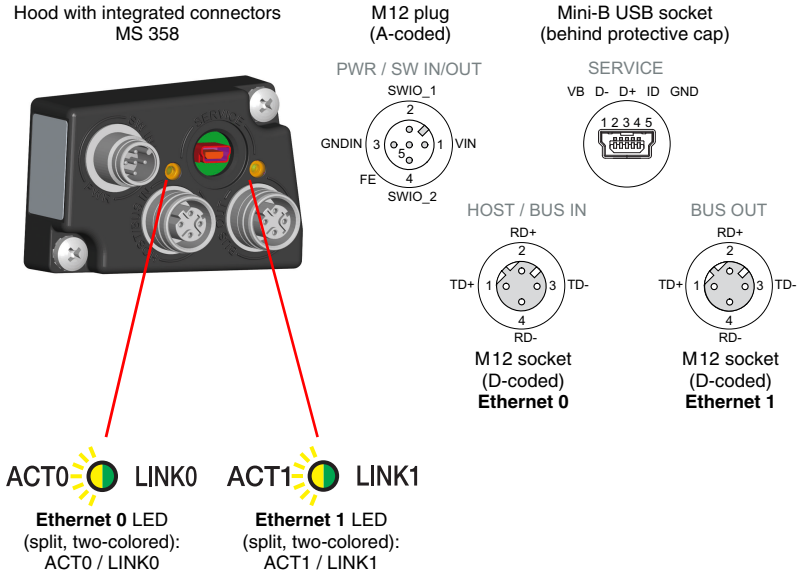

Figure 3.1: BCL 358*i*- MS 358 connector hood with M12 connectors



Notice!

The shielding connection is done via the M12 connector housing.



Notice!

The integrated parameter memory for the simple replacement of the BCL 358*i* is located in the MS 358. In the integrated parameter memory, both the settings and the network address are saved and transmitted to a new device.



Notice!

In the case of Ethernet line topology, the network is interrupted when the BCL 358*i* is removed from the MS 358.

MK 358 terminal hood with spring-loaded terminals

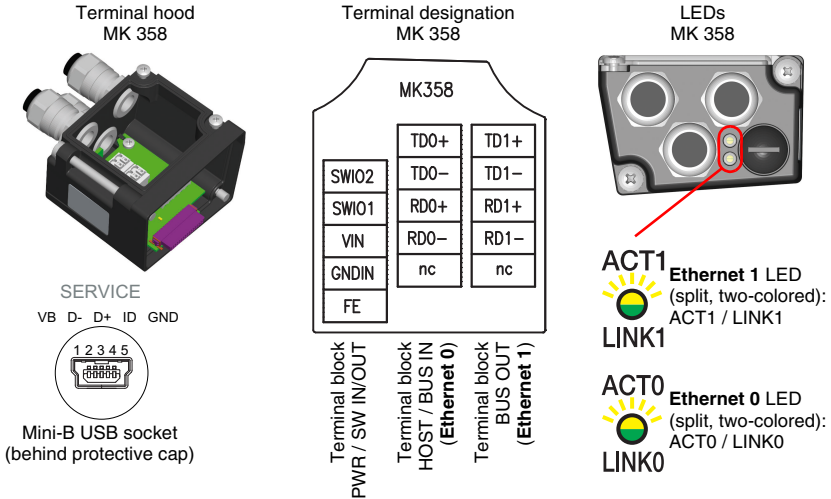

Figure 3.2: BCL 358*i* - MK 358 terminal hood with spring-loaded terminals



Notice!

The integrated parameter memory for simple exchange of the BCL 358*i* is located in the MK 358. In the integrated parameter memory, both the settings and the network address are saved and transmitted to a new device.



Notice!

In the case of Ethernet line topology, the network is interrupted when the BCL 358*i* is removed from the MK 358.

Cable fabrication and shielding connection

Remove approx. 78mm of the connection cable sheathing. 15 mm of sheath of the shielded line must be freely accessible.

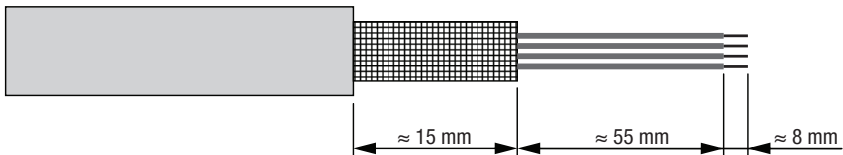

Figure 3.3: Cable fabrication for MK 358 terminal hood

The shield is automatically contacted when the cable is lead into the metal screw fitting and fastened when the cord grip is closed. Then lead the individual wires into the terminals according to the diagram. Wire end sleeves are not necessary.

3.4 Preparatory EtherNet/IP settings

↳ Connect the +18 ... 30VDC supply voltage (typ. +24VDC); the BCL 358*i* starts up.

3.4.1 BCL 358*i* on EtherNet/IP

Commissioning on the EtherNet/IP is performed according to the following scheme:

1. **Address assignment**
 - automatic via DHCP, BootP **or**
 - manual via webConfig (with a USB connection)
2. **Configuration of the participant** depending on the version of the control software:
 - either with the generic Ethernet module **or**
 - installation of the EDS file
3. **Transferring the data** to the control
4. **Adapting the device parameters** via webConfig
5. **Use explicit messaging services**



Notice!

*On delivery, the automatic address assignment via DHCP server is defined as the standard setting of the BCL 358*i* and the IP address is set to 0.0.0.0.*

The BCL 358*i* can be configured in the planning tool/control using the **EDS file** (Electronic Data Sheet) if the control supports this. PLC software **RSLogix 5000** from **Rockwell** offers EDS support for EtherNet/IP **from software version 20.00 and up**.

Without PLC support of the EDS integration, the settings are made via the **generic Ethernet module**. In this case, the respective configuration must be entered and adapted manually for each device. The parameter download from the control to the BCL 358*i* is performed during every establishment of connection. Since the parameters are stored centrally in the control, this helps during device exchange.

3.4.2 Manually setting the IP address

If your system does not include a DHCP server or if the IP addresses of the devices are to be set permanently, proceed as follows:

- Have the network administrator specify the data for IP address, net mask and gateway address of the BCL 358*i*.
- Set the IP address manually via the BootP/DHCP server tool and deactivate the DHCP operation in the BCL 358*i*. The BCL 358*i* automatically adopts these settings. A restart is not required.

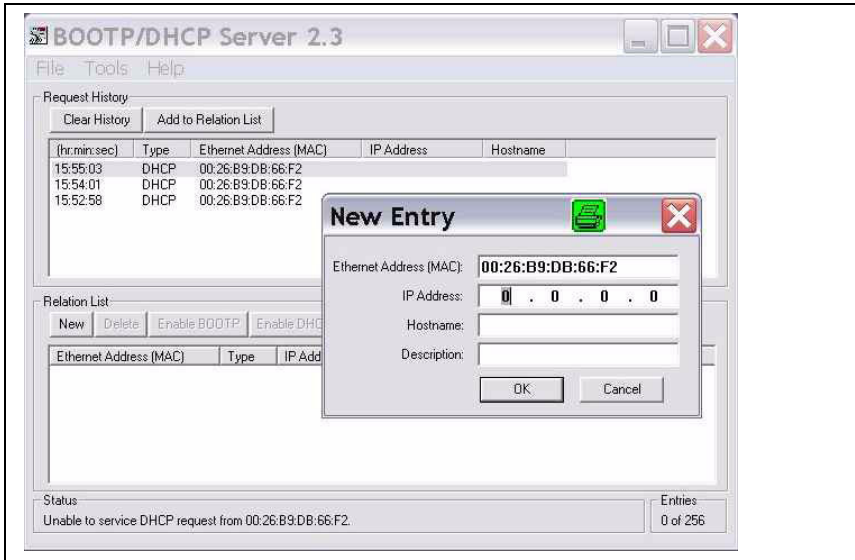

Figure 3.1: Manually setting the IP address

Alternatively, you can set the IP address manually via the webConfig tool. Proceed as follows:

- Have the network administrator specify the data for IP address, net mask and gateway address of the BCL 358*i*.
- Connect the BCL 358*i* to your computer using the service cable.
- Set these values on the BCL 358*i*. Via webConfig:
 Configuration -> Communication -> Ethernet interface



Notice!

If the IP address is set via the webConfig tool, then it becomes active after transfer to the device. A restart is not required.

3.4.3 Configure the participant

Configuration with the generic Ethernet module

In the **RSLogix 5000** configuration tool (up to software version **20.00**), a so-called **generic Ethernet module** is created under the Communication path for the **BCL 358*i***.

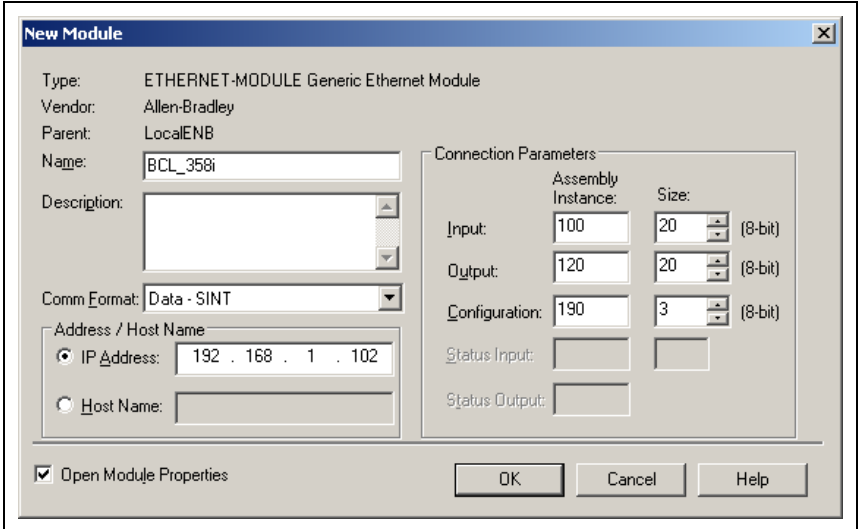

Figure 3.2: Generic Ethernet module

The input mask for the generic module describes the following parameters to be set:

- The name of the participant (can be selected freely; e.g. **BCL 358*i***).
- The format of I/O data (data - SINT = 8 bits).
- The IP address of the participant.
- The address and length of the input assembly (instance 100, instance 101 or instance 102; min 1 byte - up to max. 266 bytes for the default input assembly of the read results).
- The address and length of the output assembly (instance 120, instance 121 or instance 122; min 1 byte - up to max. 263 bytes for the default output assembly).
- The address and length of the configuration assembly (instance 190; 3 bytes).

For the exact description of the assemblies for input/output and configuration, please refer to chapter 10.

Configuration of the participant using the EDS file

From software version 20.00 and up, proceed as follows in the **RSLogix 5000** configuration tool to create the BCL 358*i* as an EtherNet/IP participant in your system:

- First, load the EDS file for the device via EDS wizard into the PLC database.



Notice!

You can find the EDS file at: www.leuze.com.

- After it has downloaded, select the device from the device list.
- Open the input dialog for setting the address and additional parameters by double-clicking on the device symbol and make the desired entries here.
- Finally, transmit the values to the control via download.

3.4.4 Transferring the data to the control (RSLogix 5000 specific)

- Activate online mode
- Select the Ethernet communication port
- Select the processor onto which the project is to be transferred
- Set the control to PROG
- Start the download
- Set the control to RUN

3.5 Further settings

After the basic configuration of the operating mode and the communication parameters, you need to carry out further settings:









- Decoding and processing the read data
 - ↳ *Define at least one code type with the desired settings.*
 - Via webConfig:
Configuration -> Decoder
- Control of the decoding
 - ↳ *Configure the connected switching inputs according to your requirements. To do this, first set the I/O mode to Input and then configure the switching behavior:*
 - Via webConfig:
Configuration -> Device -> Switching inputs/outputs
- Control of the switching outputs
 - ↳ *Configure the connected switching outputs according to your requirements. To do this, first set the I/O mode to Output and then configure the switching behavior:*
 - Via webConfig:
Configuration -> Device -> Switching inputs/outputs

3.6 Starting the device







↳ Connect the +18 ... 30VDC supply voltage (typ. +24VDC).

The BCL 358*i* starts up, the **PWR** and **NET** LEDs display the operating state. If there is a display, the bar code reading window appears in it.

PWR LED

PWR 	off	Device OFF, no supply voltage
PWR 	green flashing	Device ok, initialization phase
PWR 	green continuous light	Power On, device OK
PWR 	green, briefly off - on	Good read, successful reading
PWR 	green, briefly off - briefly red - on	No read, reading not successful
PWR 	orange continuous light	Service mode
PWR 	red flashing	Warning set
PWR 	red continuous light	Error, device error

NET LED

NET 	off	Device OFF, no supply voltage, no IP address assigned
NET 	green flashing	LED self test, no EtherNet/IP communication, no master assignment
NET 	green continuous light	Bus communication ok
NET 	red flashing	LED self test, time out in the bus communication
NET 	red continuous light	Double IP address
NET 	green/red flashing	Self test

LED ACT0 / LINK0 (on the MS 358/MK 358)

green continuous light
yellow flashing

Ethernet connected (LINK)
Data communication (ACT)

LED ACT1 / LINK1 (on the MS 358/MK 358)

green continuous light
yellow flashing

Ethernet connected (LINK)
Data communication (ACT)

**Notice!**

The detailed description of the LED states can be found in chapter 8.

If a display is available, the following information appears successively during startup:

- Startup
- Device designation e.g. BCL 358i SM 102 D
- Reading Result

If Reading Result is displayed, the device is ready.

Operation of BCL 358i

After voltage (18 ... 30VDC) has been connected to the switching input, a read process is activated. In the standard setting, all common code types for decoding are released; only the **2/5 Interleaved** code type is limited to 10 digits of code content.

If a code is moved through the reading field, the code content is decoded and forwarded to the superior system (PLC/PC) via the Ethernet.

3.7 Bar code reading

To test, you can use the following bar code in the 2/5 Interleaved format. The bar code module here is 0.5:



Provided your BCL 358*i* model has a display, the read information appears on this display. The **PWR** LED goes off briefly and then turns green again. Simultaneously, the read information is forwarded to the superior system (PLC/PC) via the Ethernet.

Please check the incoming data of the bar code information there.

Alternatively, you can use a switching input for read activation (switching signal of a photoelectric sensor or 24VDC switching signal).

4 Device description

4.1 About the bar code readers of the BCL 300*i* series

Bar code readers of the BCL 300*i* series are high-speed scanners with integrated decoder for all commonly used bar codes, e.g. 2/5 Interleaved, Code 39, Code 128, EAN 8/13 etc., as well as codes from the GS1 DataBar family.

Bar code readers of the BCL 300*i* series are available in various optics models as well as line scanners, line scanners with deflection mirrors, oscillating mirrors and also optionally as heated models.

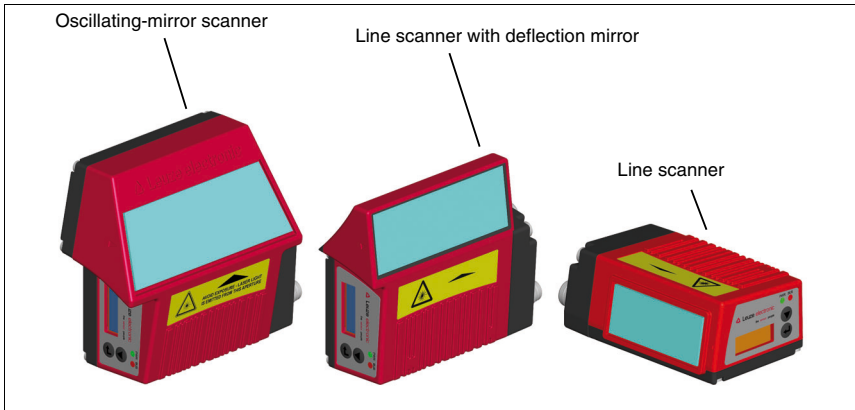

Figure 4.1: Line scanner, line scanner with deflection mirror and oscillating-mirror scanner

The extensive options for device configuration enable adaptation to a multitude of reading tasks. Due to the large reading distance combined with the great depth of field, a large opening angle and a very compact construction, the device is ideally suited for the conveyor and storage technology market.

The interfaces (**RS 232**, **RS 485** and **RS 422**) integrated in the various device models and the fieldbus systems (**PROFIBUS DP**, **PROFINET-IO**, **Ethernet TCP/IP UDP** and **EtherNet/IP**) offer optimum connection to the superior host system.

4.2 Characteristics of the bar code readers of the BCL 300*i* series

Performance characteristics:

- Integrated fieldbus connectivity = *i* -> Plug-and-Play fieldbus coupling and easy networking
- Numerous interface variants facilitate connection to the superior systems
 - RS 232, RS 422
 - RS 485 and multiNet plus slavealternatively, various fieldbus systems, such as
 - PROFIBUS DP
 - PROFINET-IO
 - Ethernet TCP/IP UDP
 - EtherNet/IP
- Integrated code fragment technology (**CRT**) enables the identification of soiled or damaged bar codes
- Maximum depth of field and reading distances from 30mm to 700mm
- Large optical opening angle and, thus, large reading field width
- High scanning rate of 1000 scans/s for fast reading tasks
- On request with display to easily detect and activate functions and status messages
- Integrated USB service interface, Mini-B type
- Easy alignment- and diagnostics functions
- Up to four possible connection technologies
- Two freely programmable switching inputs/outputs for the activation or signaling of states
- Automatic monitoring of the read quality with **autoControl**
- Automatic recognition and setting of the bar code type using **autoConfig**
- Reference code comparison
- Optional heating models to -35 °C
- Heavy-duty housing of protection class IP 65



Notice!

Information on technical data and characteristics can be found in chapter 5.

General information

The integrated fieldbus connectivity = *i* contained in the bar code readers of the BCL 300*i* series facilitates the use of identification systems which function without connector unit or gateways. The integrated fieldbus interface considerably simplifies handling. The Plug-and-Play concept enables easy networking and very simple commissioning: Directly connect the respective fieldbus and all configuration is performed with no additional software.

For decoding bar codes, the bar code readers of the BCL 300*i* series make available the proven **CRT decoder** with code fragment technology:

The proven code fragment technology (**CRT**) enables bar code readers of the BCL 300*i* series to read bar codes with a small bar height, as well as bar codes with a damaged or soiled print image.

With the aid of the **CRT decoder**, bar codes can also be read without problem in other demanding situations, such as with a large tilt angle (azimuth angle or even twist angle).

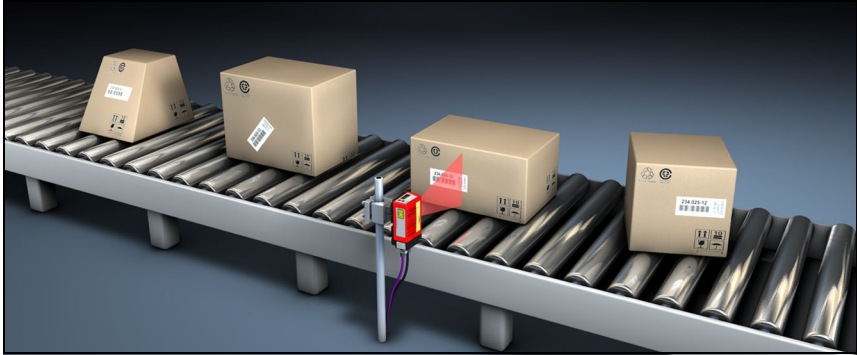

Figure 4.2: Possible bar code orientation

The BCL 358*i* can be operated and configured using the integrated webConfig tool via the USB service interface; alternatively, the bar code readers can be adjusted using configuration commands via the host/service interface.

The BCL 358*i* needs a suitable activation to start a read process as soon as an object is in the reading field. This opens a time window ("reading gate") in the BCL 358*i* for the read process during which the bar code reader has time to detect and decode a bar code.

In the basic setting, triggering takes place through an external reading cycle signal. Alternative activation options include online commands via the host interface and the **autoRefIAct** function.

Through the read operation, the BCL 358*i* collects additional useful pieces of data for diagnosis which can also be transmitted to the host. The quality of the read operation can be inspected using the **alignment mode** which is integrated in the webConfig tool.

An optional display in English with buttons is used to operate the BCL 358*i* as well as for visualization purposes. Two LEDs provide additional optical information on the current operating state of the device.

The two freely configurable switching inputs/outputs **SWIO1** and **SWIO2** can be assigned various functions and control e.g. activation of the BCL 358*i* or external devices, such as a PLC.

System, warning and error messages provide assistance in setup/troubleshooting during commissioning and read operation.

4.3 Device construction

BCL 358i bar code readers

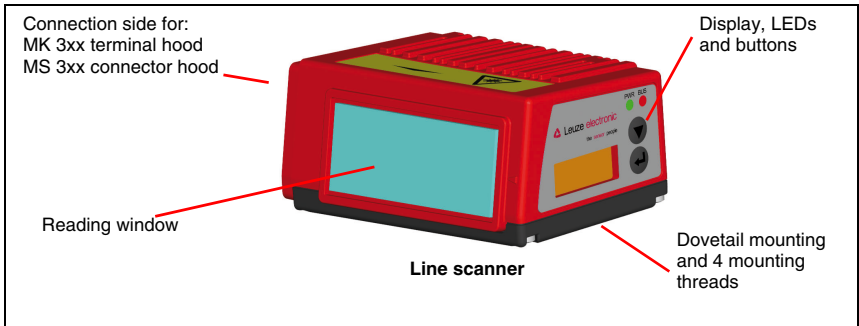

Figure 4.3: *BCL 358i* device construction - line scanner

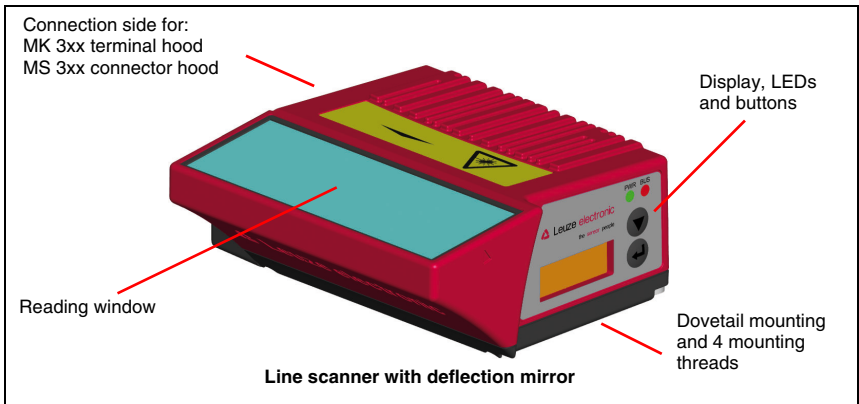

Figure 4.4: *BCL 358i* device construction - line scanner with deflection mirror

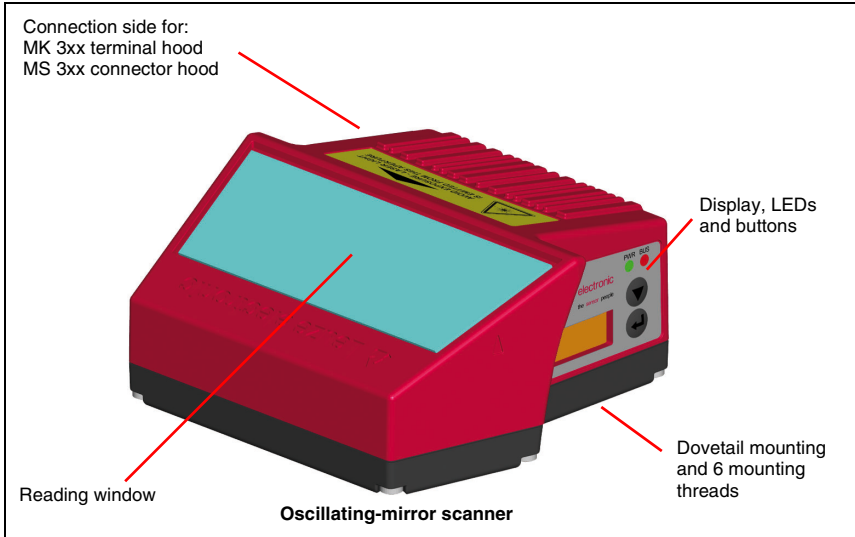

Figure 4.5: BCL 358*i* device construction - oscillating-mirror scanner

MS 358 connector hood

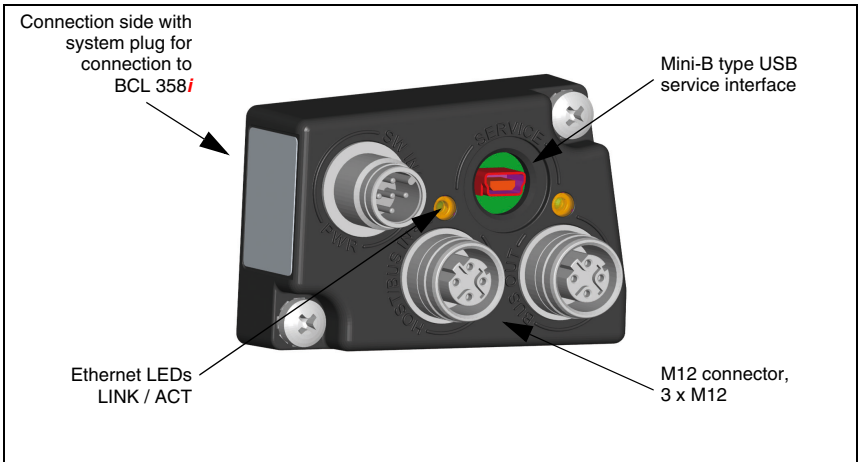

Figure 4.6: Device construction MS 358 connector hood

MK 358 terminal hood

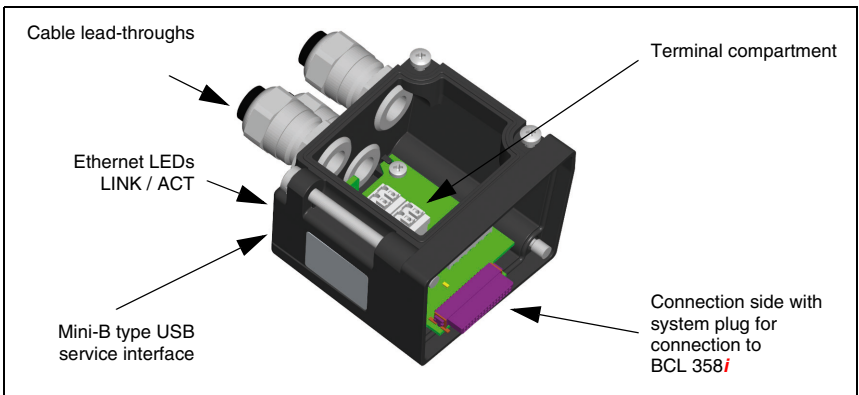

Figure 4.7: Device construction MK 358 terminal hood

4.4 Reading techniques

4.4.1 Line scanner (single line)

A line (scan line) scans the label. Due to the opt. opening angle, the reading field width is dependent on the read distance. Through the movement of the object, the entire bar code is automatically transported through the scan line.

The integrated code fragment technology permits twisting of the bar code (tilt angle) within certain limits. These are dependent on the transport speed, the scanning rate of the scanner and the bar code properties.

Areas of application of the line scanner

The line scanner is used:

- when the bars of the bar code are printed in the conveying direction ('ladder arrangement').
- with bar codes having very short bar lengths.
- when the ladder code is turned out of the vertical position (tilt angle).
- when the reading distance is large.



Figure 4.8: Deflection principle for the line scanner

4.4.2 Line scanner with oscillating mirror

The oscillating mirror deflects the scan line additionally to both sides across the scan direction at a randomly adjustable oscillation frequency. In this way, the BCL 358*i* can also scan larger areas or spaces for bar codes. The reading field height (and the scan line length useful for evaluation) depends on the reading distance due to the optical opening angle of the oscillating mirror.

Areas of application of the line scanner with oscillating mirror

For line scanners with oscillating mirror, oscillation frequency, start/stop position etc. are adjustable. It is used:

- when the position of the label is not fixed, e.g. on pallets – various labels can, thus, be detected at various positions.
- when the bars of the bar code are printed perpendicular to the conveying direction ('picket fence arrangement').
- when reading stationary objects.
- when a large reading field (reading window) has to be covered.

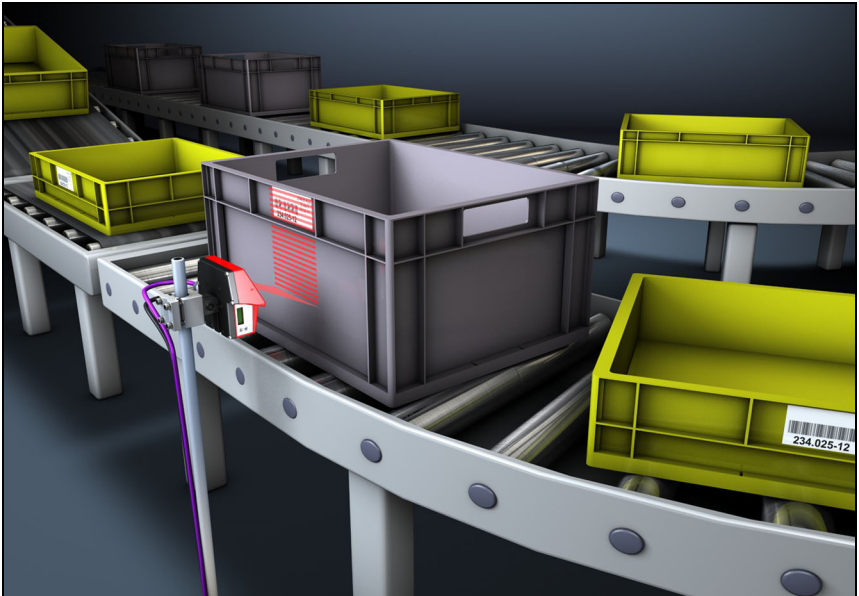

Figure 4.9: Deflection principle for the line scanner with oscillating mirror add-on

4.4.3 Raster scanner (raster line)

Multiple scan lines scan the label. Due to the optical opening angle, the reading field width is dependent on the reading distance. Provided the code is located in the reading field, it can be read during standstill. If the code moves through the reading field, it is scanned by multiple scan lines.

The integrated code fragment technology permits twisting of the bar code (tilt angle) within certain limits. These are dependent on the transport speed, the scanning rate of the scanner and the bar code properties. In most cases, everywhere a line scanner is used, a raster scanner can be used.

Areas of application of the raster scanner:

The raster scanner is used:

- when the bars of the bar code are perpendicular to the conveying direction ('picket fence arrangement')
- with bar codes with low height displacement
- with very glossy bar codes



Figure 4.10: Deflection principle for the raster scanner

4.5 Fieldbus systems

Various product variants of the BCL 300*i* series are available for connecting to different fieldbus systems such as PROFIBUS DP, PROFINET, Ethernet and EtherNet/IP.

4.5.1 EtherNet/IP

The BCL 358*i* is designed as an EtherNet/IP device (acc. to IEEE 802.3) with a standard baud rate of 10/100 Mbit. EtherNet/IP makes use of the Common Industrial Protocol (**CIP**) as an application layer for the user. The functionality of the device is defined via parameter sets which are clustered in objects, classes and instances. These are contained in an **EDS** file which, depending on the version of the control software, can be used to configure and integrate the BCL 358*i* into the system. A fixed MAC ID is assigned to each BCL 358*i* by the manufacturer; this ID cannot be changed.

The BCL 358*i* automatically supports the transmission rates of 10 Mbit/s (10Base T) and 100 Mbit/s (100Base TX), as well as auto-negotiation and auto-crossover.

Either an MS 358 connector hood or an MK 358 terminal hood is available on the BCL 358*i* for the electrical connection of the supply voltage, the interface and the switching inputs and outputs.

Additional information on the electrical connection can be found in chapter 7.

The BCL 358*i* supports the following protocols and services:

- EtherNet/IP
- DHCP
- HTTP
- ARP
- PING
- Telnet
- BootP



Notice!

*The BCL 358*i* communicates via the Common Industrial Protocol (CIP).
CIP Safety, **CIP Sync** and **CIP Motion** are not supported by the BCL 358*i*.*

Further information on commissioning can be found in chapter 10.

4.5.2 Ethernet – star topology

The BCL 358*i* can be operated as a single device (stand-alone) in an Ethernet star topology with individual IP address.

The address can either be manually set permanently via the BootP/webConfig tool or assigned dynamically via a DHCP server.

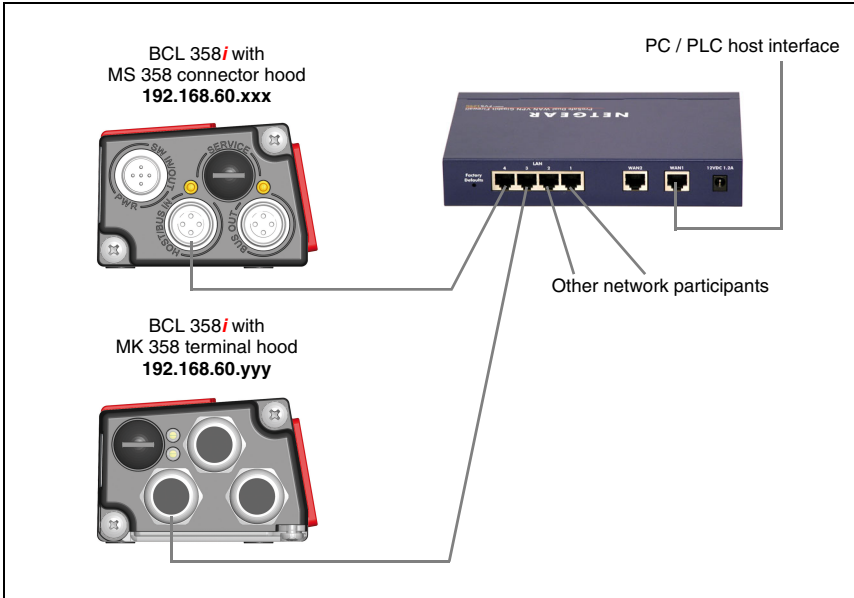

Figure 4.11: Ethernet with star topology



Notice!

The BCL 358*i* does **not** support the DLR (Device Level Ring) ring structure determined by the ODVA.

4.5.3 Ethernet – linear topology

The innovative further development of the BCL 358*i* with integrated switch functionality offers the option of connecting multiple bar code readers of type BCL 358*i* to one another without direct connection to a switch. In addition to the classic "star topology", a "linear topology" is thus also possible.

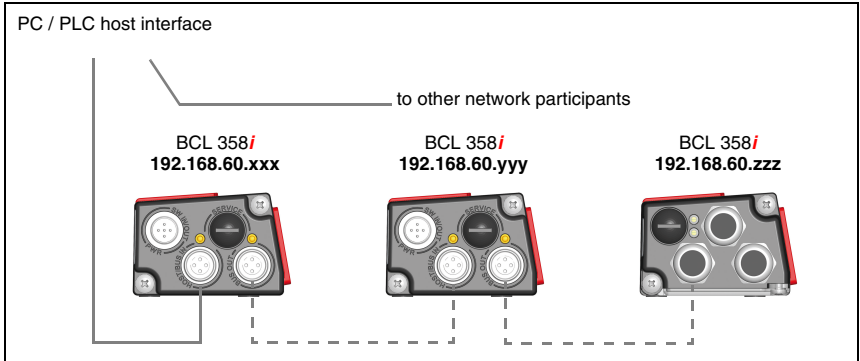

Figure 4.12: Ethernet with linear topology

Each participant in this network requires its own unique IP address which is assigned to it via the DHCP process. Alternatively, the address can be permanently assigned to it manually via BootP or webConfig tool.

The maximum length of a segment (connection from the hub to the last participant) is limited to 100m.



Notice!

The BCL 358*i* does **not** support the DLR (Device Level Ring) ring structure determined by the ODVA.

4.6 Heater

For low-temperature applications to min. -35°C (e.g. in cold storage), the bar code readers of the BCL 358*i* series can optionally be permanently fitted with a built-in heating and these bar code readers purchased as separate device models.

4.7 autoReflAct

AutoReflAct stands for **Automatic Reflector Activation** and permits an activation without additional sensors. This is achieved by directing the scanner with reduced scanning beam towards a reflector mounted behind the conveyor path.



Notice!

Compatible reflectors are available on request.

As long as the scanner is targeted at the reflector, the reading gate remains closed. If, however, the reflector is blocked by an object such as a container with a bar code label, the scanner activates the read procedure, and the label on the container is read. When the path from the scanner to the reflector has cleared, the read procedure has completed and the scanning beam is reduced and again directed onto the reflector. The reading gate is closed.

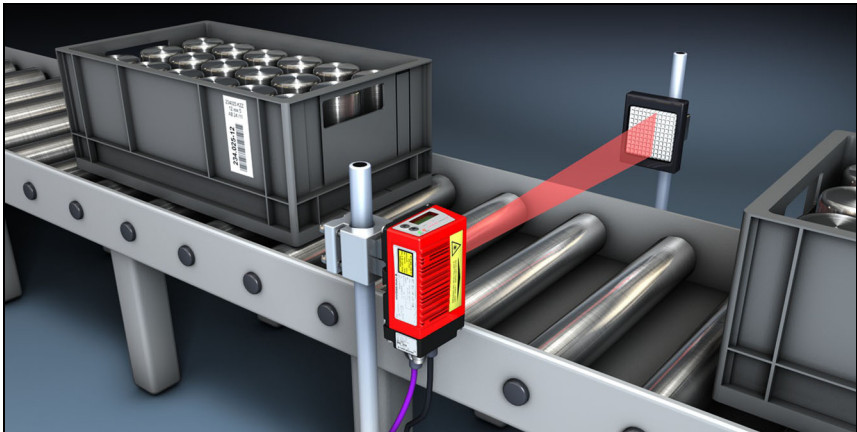

Figure 4.13: Reflector arrangement for autoReflAct

The **autoReflAct** function uses the scanning beam to simulate a photoelectric sensor and thus permits an activation without additional sensor system.

4.8 Reference codes

The BCL 358*i* offers the possibility of storing one or two reference codes.

It is possible to store the reference codes via the webConfig tool or via online commands.

The BCL 358*i* can compare read bar codes with one and/or both reference codes and execute user-configurable functions depending on the comparison result.

4.9 autoConfig

With the autoConfig function, the BCL 358*i* offers the user who only wishes to simultaneously read one code type (symbology) with one number of digits an extremely simple and convenient configuration option.

After starting the autoConfig function via the switching input or from a superior control, it is sufficient to position a bar code label with the desired code type and number of digits in the reading field of the BCL 358*i*.

Afterward, bar codes with the same code type and number of digits are recognized and decoded.

5 Specifications

5.1 General specifications of the bar code readers

5.1.1 Line scanner / raster scanner

Type	BCL 358<i>i</i> EtherNet/IP
Type	Line scanner without heating
Optical data	
Light source	Laser diode $\lambda = 655\text{nm}$ (red light)
Beam exit	Front
Scanning rate	1000 scans/s
Beam deflection	By means of rotating polygon wheel
Useful opening angle	Max. 60°
Optics models / resolution	High Density (N): 0.127 ... 0.20mm Medium Density (M): 0.20 ... 0.5mm Low Density (F): 0.30 ... 0.5mm Ultra Low Density (L): 0.35 ... 0.8mm
Reading distance	See reading field curves
Laser class	2 (acc. to EN 60825-1 and 21 CFR 1040.10 with Laser Notice No. 50)
Bar code data	
Code types	2/5 Interleaved, Code 39, Code 128, EAN 128, EAN / UPC, Codabar, Code 93, GS1 DataBar, EAN Addendum
Bar code contrast (PCS)	$\geq 60\%$
External light tolerance	2000 lx (on the bar code)
Number of bar codes per scan	3
Electrical data	
Interface type	2x Ethernet on 2x M12 (D-coded)
Protocols	EtherNet/IP
Baud rate	10/100MBaud
Data formats	
Service interface	Mini-B type USB 2.0 socket
Switching input / switching output	2 switching inputs/outputs, freely programmable functions - Switching input: 18 ... 30VDC depending on supply voltage, I max. = 8 mA - Switching output: 18 ... 30VDC, depending on supply voltage, I max. = 60 mA (short-circuit proof) Switching inputs/outputs protected against polarity reversal!
Operating voltage	18 ... 30VDC (Class 2, safety class III)
Power consumption	Max. 4.5W
Operating and display elements	
Display	Monochromatic graphical display, 128 x 32 pixel, with background lighting
Keyboard	2 buttons
LEDs	2 LEDs for power (PWR) and bus state (NET), two-colored (red/green)

Table 5.1: Specifications of the BCL 358*i* line/raster scanners without heating

Type	BCL 358<i>i</i> EtherNet/IP
Type	Line scanner without heating
Mechanical data	
Protection class	IP 65 ¹⁾
Weight	270g (without connection hood)
Dimensions (WxHxD)	44 x 95 x 68mm (without connection hood)
Housing	Diecast aluminum
Environmental data	
Operating temperature range	0°C ... +40°C
Storage temperature range	-20°C ... +70°C
Air humidity	Max. 90% rel. humidity, non-condensing
Vibration	IEC 60068-2-6, test FC
Shock	IEC 60068-2-27, test Ea
Continuous shock	IEC 60068-2-29, test Eb
Electromagnetic compatibility	EN 55022; IEC 61000-6-2 (contains IEC 61000-4-2, -3, -4, -5 and -6) ²⁾

Table 5.1: Specifications of the BCL 358*i* line/raster scanners without heating

- 1) Only with the MS 358 or MK 358 connection hood and screwed-on M12 connectors or cable lead-throughs and mounted caps. Minimum tightening torque of the housing connection screws on the connection hood 1.4Nm!
- 2) This is a Class A product. In a domestic environment this product may cause radio interference, in which case the operator may be required to take adequate measures.



Attention!

For UL applications, use is permitted exclusively in Class 2 circuits according to NEC (National Electric Code).



*The BCL 358*i* bar code readers are designed in accordance with safety class III for supply by PELV (protective extra-low voltage).*

5.1.2 Oscillating-mirror scanner

Specifications same as for line scanner without heating with the following differences:

Type	BCL 358<i>i</i> EtherNet/IP	
Type	Oscillating-mirror scanner without heating	
Optical data		
Beam exit	Lateral zero position at an angle of 90°	
Beam deflection	Via rotating polygon wheel (horizontal) and stepping motor with mirror (vertical)	
Oscillation frequency	0 ... 10Hz (adjustable, max. frequency is dependent on set swivel angle)	
Max. swivel angle	±20°(adjustable)	
Reading field height	See reading field curves	
Electrical data		
Power consumption	Max. 9.0W	
Mechanical data		
Weight	580g (without connection hood)	
Dimensions (WxHxD)	58 x 125 x 110mm (without connection hood)	

Table 5.2: Specifications of the BCL 358*i* oscillating-mirror scanners without heating

5.1.3 Line scanner / raster scanner with deflection mirror

Specifications same as for line scanner without heating with the following differences:

Type	BCL 358<i>i</i> EtherNet/IP	
Type	Line scanner with deflection mirror without heating	
Optical data		
Beam exit	Lateral zero position at an angle of 105°	
Beam deflection	Via rotating polygon wheel (horizontal) and deflection mirror (vertical)	
Electrical data		
Power consumption	Max. 4.5W	
Mechanical data		
Weight	350g (without connection hood)	
Dimensions (WxHxD)	44 x 103 x 96mm (without connection hood)	

Table 5.3: Specifications of the BCL 358*i* deflection mirror scanners without heating

5.2 Heating models of the bar code readers

The BCL 358*i* bar code readers are optionally available as models with integrated heating. In this case, heating is permanently installed ex works. Self-installation on-site by the user is not possible!

Features

- Integrated heating (permanently installed)
- Extends the application range of the BCL 358*i* to -35°C
- Supply voltage 18 ... 30VDC
- BCL 358*i* enabling through an internal temperature switch (switch-on delay about 30min for 24VDC and minimum ambient temperature of -35°C)
- Necessary conductor cross-section for the voltage supply: at least 0.75mm²; the use of ready-made cables is, thus, not possible.

Construction

The heating consists of two parts:

- The front cover heater
- The housing heater

Function

When the 24VDC supply voltage is applied to the BCL 358*i*, a temperature switch initially only connects the heating to current (front cover heater and housing heater). During the heating phase (around 30min), when the inside temperature rises above 15°C, the temperature switch connects the BCL 358*i* to the supply voltage. This is followed by the self test and the changeover to read operation. The "PWR" LED lights up, showing overall readiness for operation.

When the inside temperature reaches approximately 18 °C, another temperature switch turns the housing heater off and, if necessary, back on again (if the inside temperature drops below 15°C). This does not interrupt the read operation. The front cover heater remains activated until an inside temperature of 25°C is reached. At temperatures above this, the front cover heater switches off and, with a switching hysteresis of 3°C, back on again at an inside temperature below 22°C.

Mounting location



Notice!

*The mounting location is to be selected such that it does not expose the BCL 358*i* with heating directly to a cold air stream. To achieve an optimal heating effect, the BCL 358*i* should be mounted so that it is thermally isolated.*

Electrical connection

The required core cross section of the connection cable for the voltage supply must be at least 0.75 mm².



Attention!

The voltage supply must not be looped through from one device to the next.

Power consumption

The energy requirement depends on the model:

- the line/raster scanner with heating consumes a maximum of 27W power.
- the line scanner with oscillating mirror and heating consumes a maximum of 45W power.
- the line/raster scanner with deflection mirror and heating consumes a maximum of 27W power.

These values are based on operation with unconnected switching outputs.

5.2.1 Line scanner / raster scanner with heater

Specifications same as for line scanner without heating with the following differences:

Type	BCL 358<i>i</i> EtherNet/IP
Type	Line scanner with heater
Electrical data	
Operating voltage	18 ... 30VDC
Power consumption	Max. 27.0W
Structure of the heating	Housing heating and separate heating of the optics glass
Warmup time	Min. 30min at +24VDC and an ambient temperature of -35°C
Min. conductor cross section	Conductor cross section of at least 0.75mm ² for the supply voltage supply line. Wiring through of the voltage supply to multiple heating devices is not permissible. Standard, M12 ready-made cable not usable (insufficient cable cross-section)
Environmental data	
Operating temperature range	-35°C ... +40°C
Storage temperature range	-20°C ... +70°C

Table 5.4: Specifications of the BCL 358*i* line/raster scanners with heating

5.2.2 Oscillating-mirror scanner with heating

Specifications same as for line scanner without heating with the following differences:

Type	BCL 358<i>i</i> EtherNet/IP
Type	Oscillating-mirror scanner with heating
Optical data	
Useful opening angle	Max. 60°
Max. swivel angle	± 20°(adjustable)

Table 5.5: Specifications of the BCL 358*i* oscillating-mirror scanners with heating

Type	BCL 358<i>i</i> EtherNet/IP
Type	Oscillating-mirror scanner with heating
Electrical data	
Operating voltage	18 ... 30VDC
Power consumption	Max. 45.0W
Structure of the heating	Housing heating and separate heating of the optics glass
Warmup time	Min. 30min at +24VDC and an ambient temperature of -35°C
Min. conductor cross section	Conductor cross section of at least 0.75mm ² for the supply voltage supply line. Wiring through of the voltage supply to multiple heating devices is not permissible. Standard, M12 ready-made cable not usable (insufficient cable cross-section)
Environmental data	
Operating temperature range	-35°C ... +40°C
Storage temperature range	-20°C ... +70°C

Table 5.5: Specifications of the BCL 358*i* oscillating-mirror scanners with heating

5.2.3 Line scanner / raster scanner with deflection mirror and heating

Specifications same as for line scanner without heating with the following differences:

Type	BCL 358<i>i</i> EtherNet/IP
Type	Deflection mirror scanner with heating
Optical data	
Useful opening angle	Max. 60°
Electrical data	
Operating voltage	18 ... 30VDC
Power consumption	Max. 27.0W
Structure of the heating	Housing heating and separate heating of the optics glass
Warmup time	Min. 30min at +24VDC and an ambient temperature of -35°C
Min. conductor cross section	Conductor cross section of at least 0.75mm ² for the supply voltage supply line. Wiring through of the voltage supply to multiple heating devices is not permissible. Standard, M12 ready-made cable not usable (insufficient cable cross-section)
Environmental data	
Operating temperature range	-35°C ... +40°C
Storage temperature range	-20°C ... +70°C

Table 5.6: Specifications of the BCL 358*i* deflection mirror scanners with heating

5.3 Dimensioned drawings

5.3.1 Dimensioned drawing of complete overview of the BCL 358*i* with MS 3xx / MK 3xx

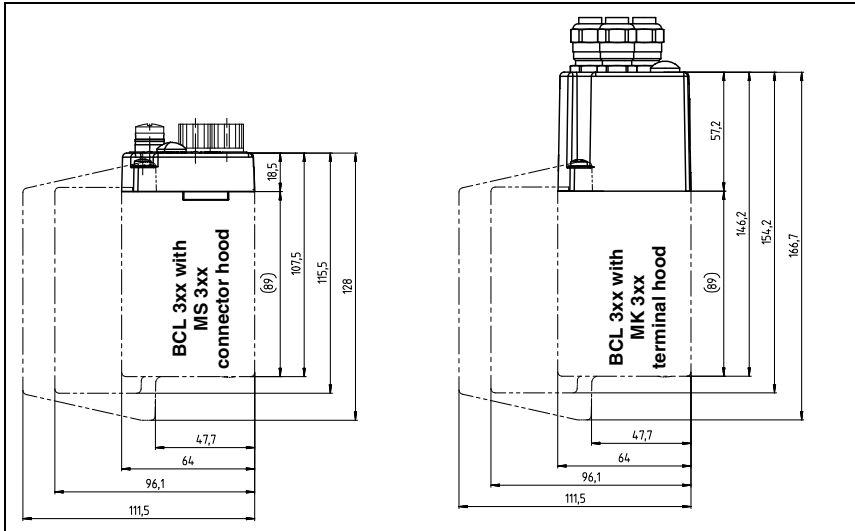

Figure 5.1: Dimensioned drawing of complete overview of the BCL 358*i* with MS 3xx / MK 3xx

5.3.2 Dimensioned drawing of line scanner with / without heating

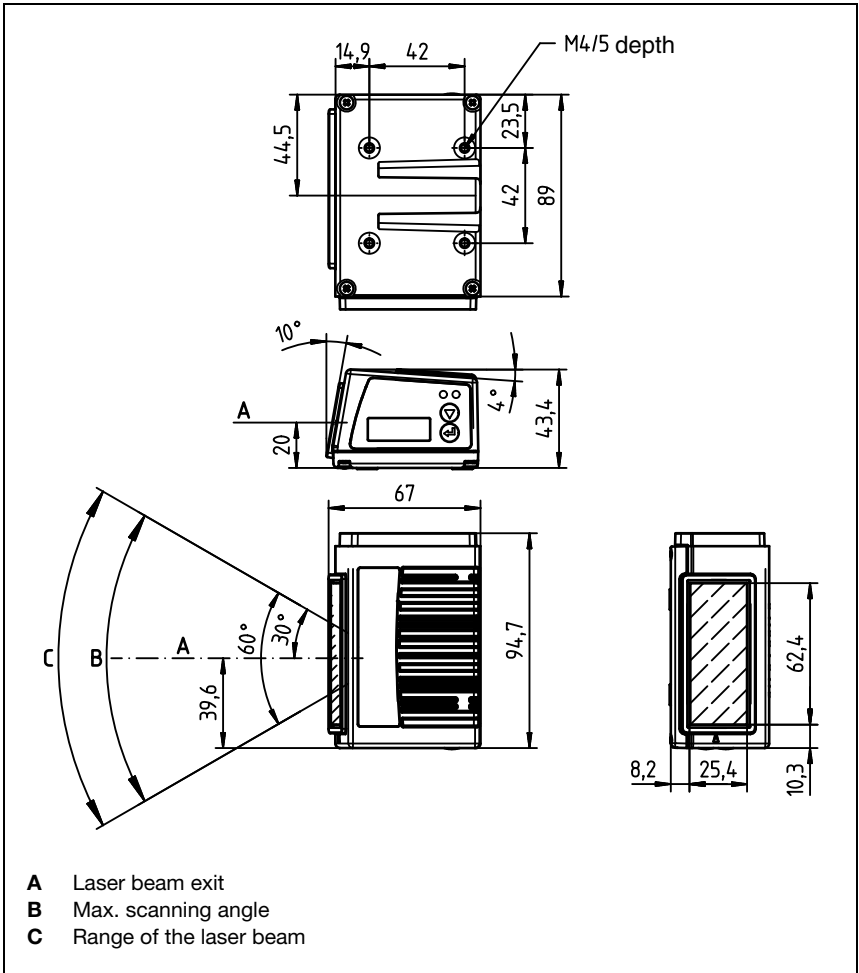

Figure 5.2: Dimensioned drawing BCL 358*i* line scanner S...102

5.3.3 Dimensioned drawing of deflection mirror scanner with / without heating

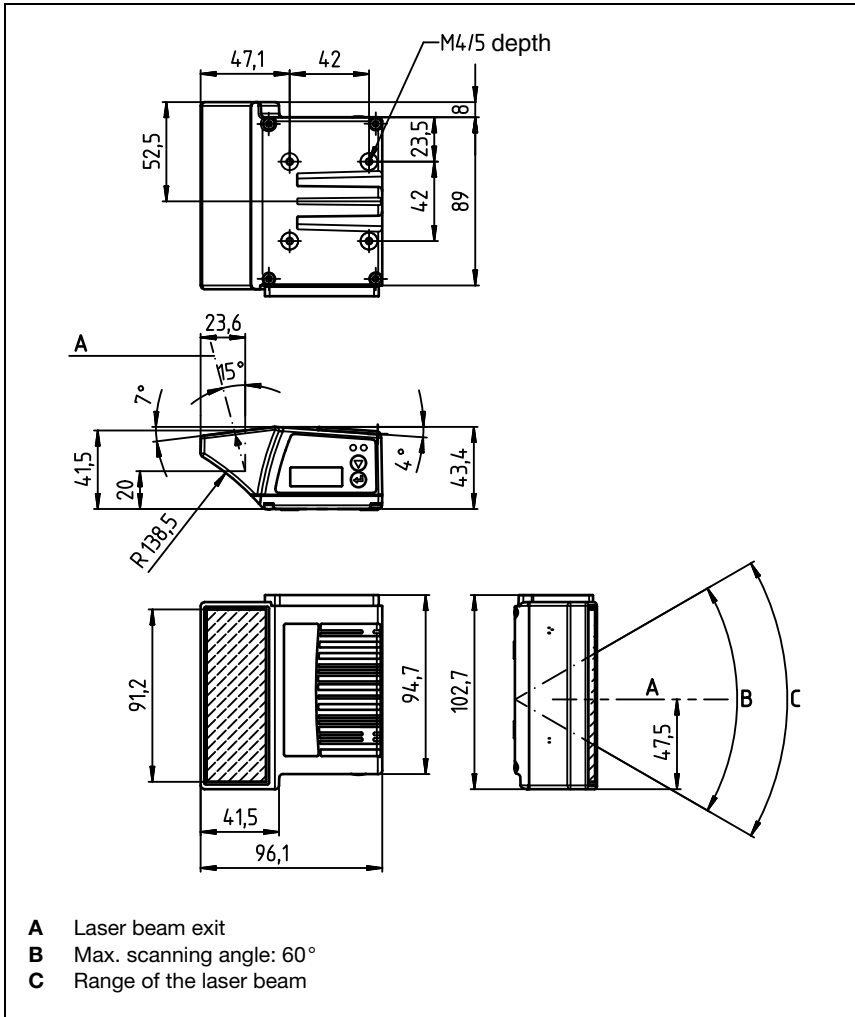

Figure 5.3: Dimensioned drawing BCL 358*i* deflection mirror scanner S...100

5.3.4 Dimensioned drawing of oscillating-mirror scanner with / without heating

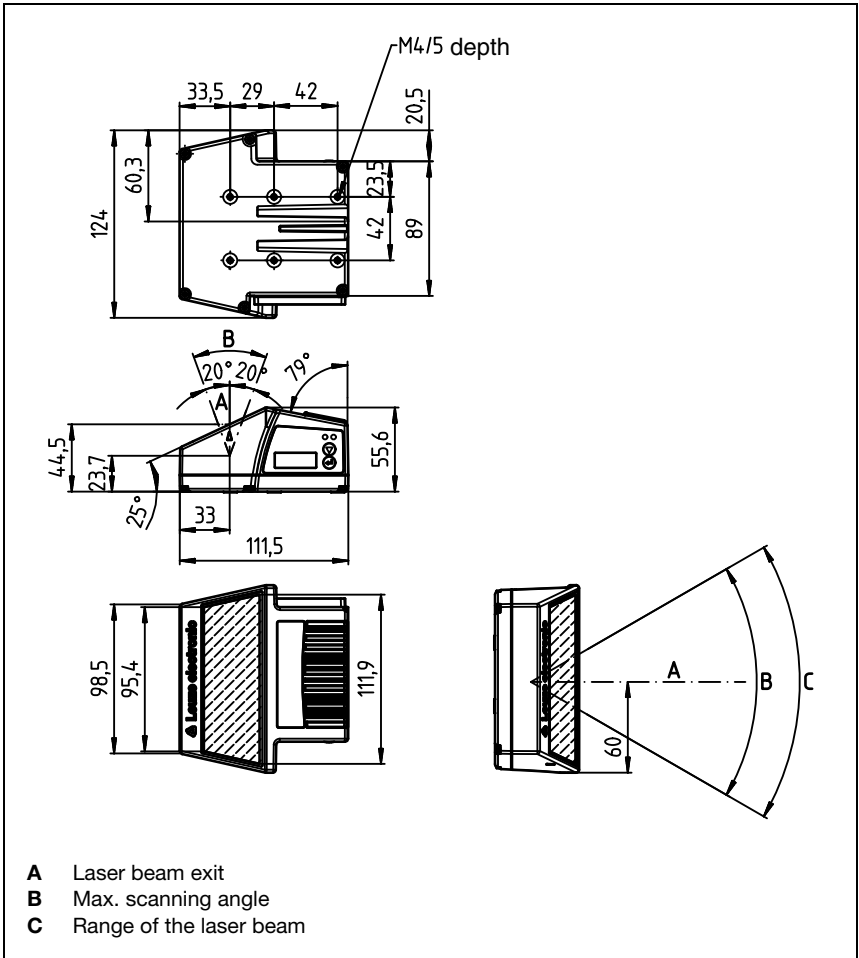

Figure 5.4: Dimensioned drawing BCL 358*i* oscillating mirror scanner O...100

5.3.5 Dimensioned drawing of MS 3xx connector hood / MK 3xx terminal hood

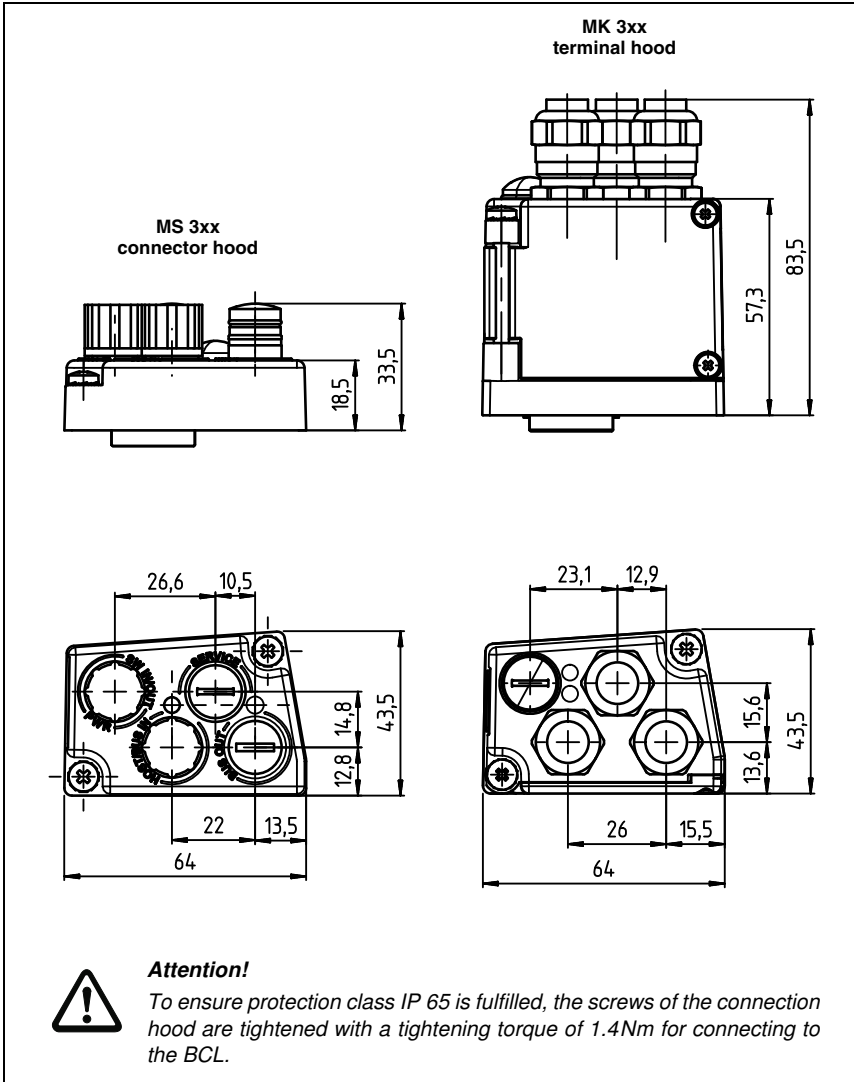

Figure 5.5: Dimensioned drawing of MS 3xx connector hood / MK 3xx terminal hood

5.4 Reading field curves / optical data

5.4.1 Bar code characteristics



Notice!

Please note that the size of the bar code module influences the maximum reading distance and the width of the reading field. Therefore, when selecting a mounting location and/or the bar code label, take into account the different reading characteristics of the scanner with various bar code modules.

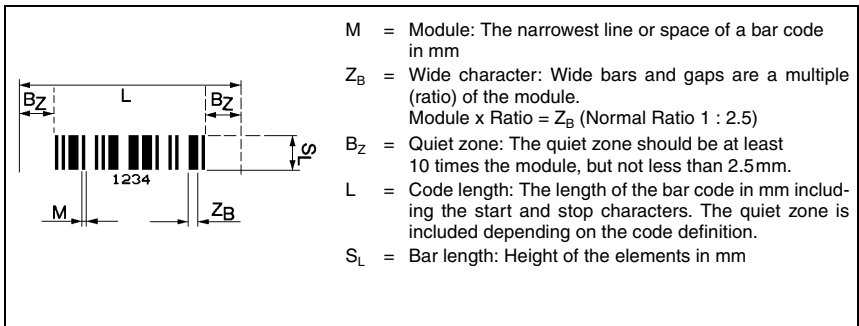

Figure 5.6: The most important characteristics of a bar code

The range in which the bar code can be read by the BCL 358*i* (the so-called reading field) depends on the quality of the printed bar code and its dimensions.

Therefore, above all, the module of a bar code is decisive for the size of the reading field.



Notice!

A rule of thumb: The smaller the module of the bar code is, the smaller the maximum reading distance and reading field width will be.

5.4.2 Raster scanner

A raster variant is also available in the BCL 300*i* series. The BCL 300*i* as a raster scanner projects 8 scan lines which vary depending on the reading distance from the raster aperture.

		Distance [mm] starting at the zero position						
		50	100	200	300	400	450	700
Raster line cover [mm] all raster lines	Front scanner	8	14	24	35	45	50	77
	Deflection mirror scanner	12	17	27	38	48	54	80

Table 5.7: Raster line cover as a function of the distance

5.5 Reading field curves



Notice!

Please notice that the real reading fields are also influenced by factors such as labeling material, printing quality, reading angle, printing contrast etc., and may thus deviate from the reading fields specified here.

The reading field curves also apply for the variants with heating.

The zero position of the reading distance always refers the front edge of the housing of the beam exit and is shown in figure 5.7 for the three housing types of the BCL 358*i*.

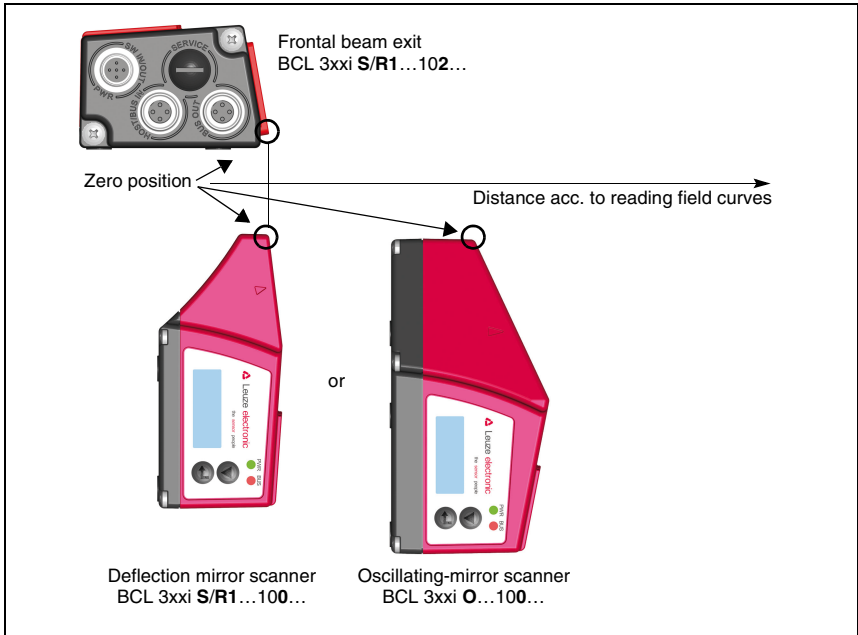

Figure 5.7: Zero position of the reading distance

Reading conditions for the reading field curves

Bar code type	2/5 Interleaved
Ratio	1:2.5
ANSI specification	class A
Reading rate	> 75%

Table 5.8: Reading conditions

5.5.1 High Density (N) - optics: BCL 358*i*/S/R1 N 102 (H)

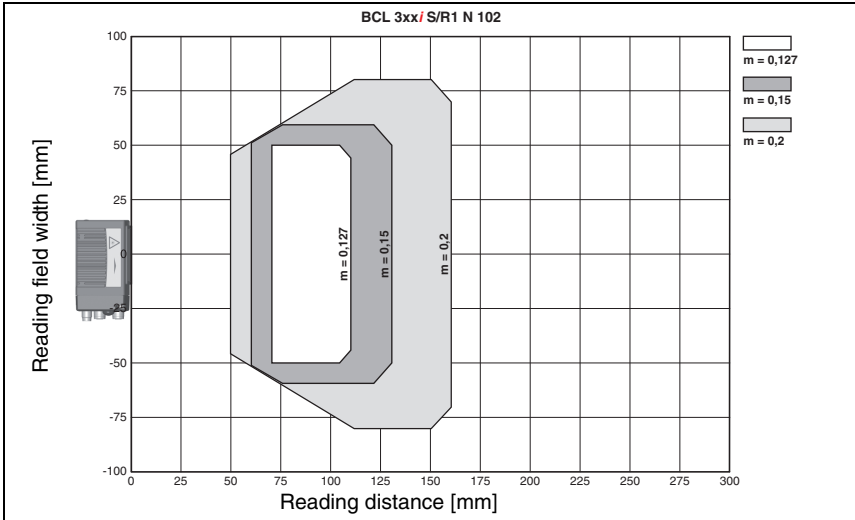

Figure 5.8: "High Density" reading field curve for line scanner without deflection mirror

5.5.2 High Density (N) - optics: BCL 358*i*/S/R1 N 100 (H)

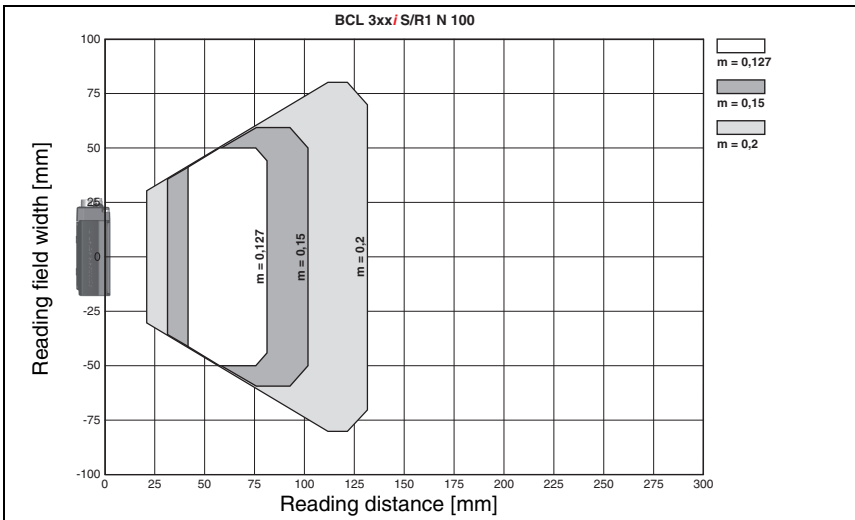

Figure 5.9: "High Density" reading field curve for line scanner with deflection mirror

The reading field curve applies for the reading conditions stated in table 5.8.

5.5.3 Medium Density (M) - optics: BCL 358*i* S/R1 M 102 (H)

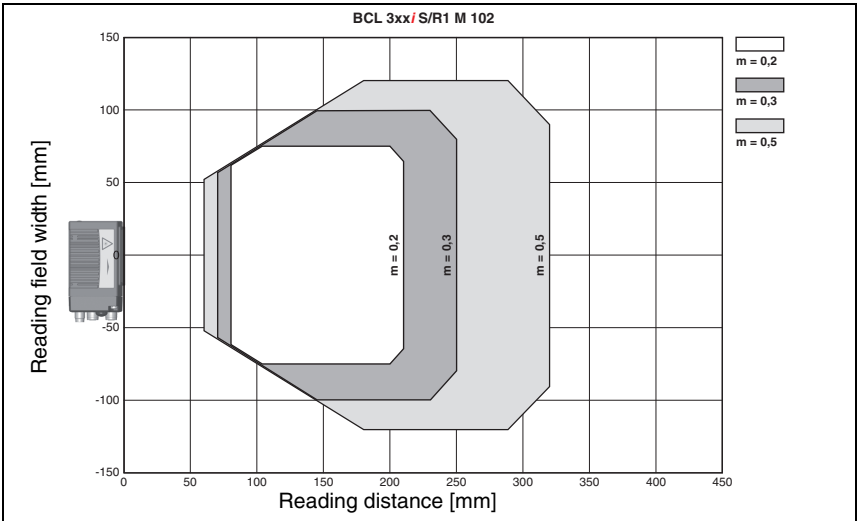

Figure 5.10: "Medium Density" reading field curve for line scanner without deflection mirror

5.5.4 Medium Density (M) - optics: BCL 358*i* S/R1 M 100 (H)

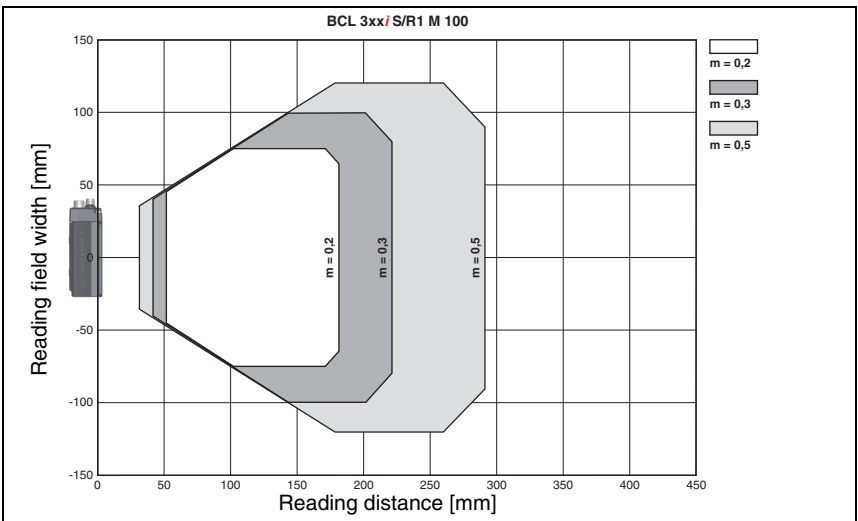

Figure 5.11: "Medium Density" reading field curve for line scanner with deflection mirror

The reading field curves apply for the reading conditions stated in table 5.8.

5.5.5 Medium Density (M) - optics: BCL 358*i* OM 100 (H)

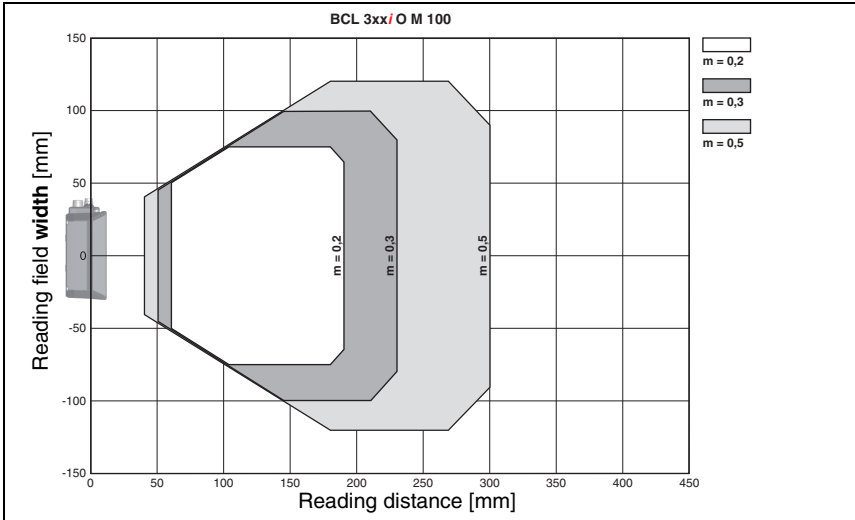

Figure 5.12: "Medium Density" reading field curve for oscillating-mirror scanners

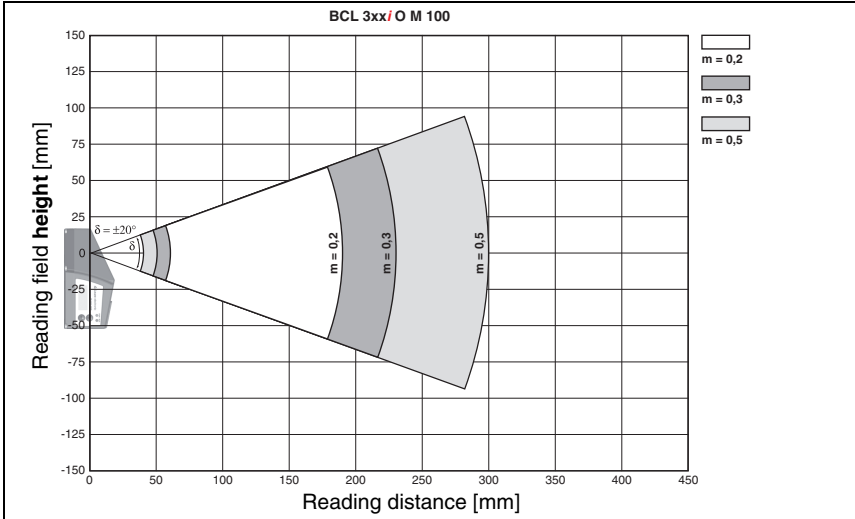

Figure 5.13: Lateral "Medium Density" reading field curve for oscillating-mirror scanners

The reading field curves apply for the reading conditions stated in table 5.8.

5.5.6 Low Density (F) - optics: BCL 358*i* S/R1 F 102 (H)

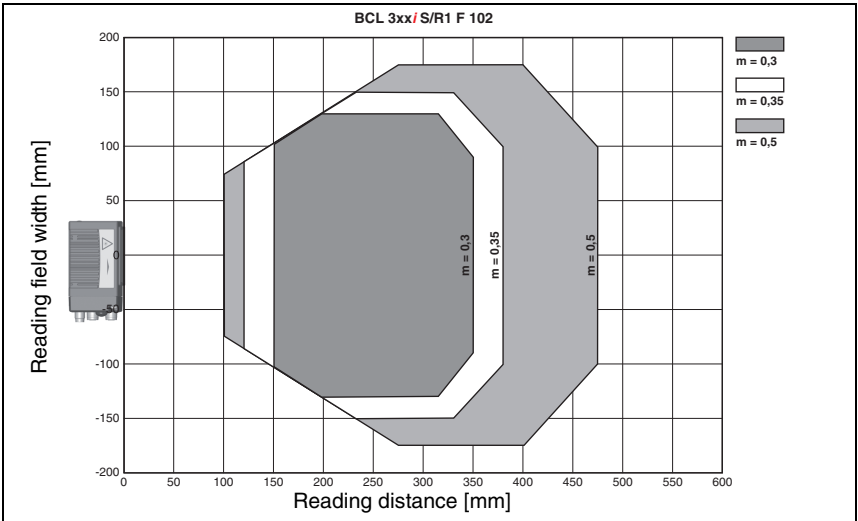

Figure 5.14: "Low Density" reading field curve for line scanner without deflection mirror

5.5.7 Low Density (F) - optics: BCL 358*i* S/R1 F 100 (H)

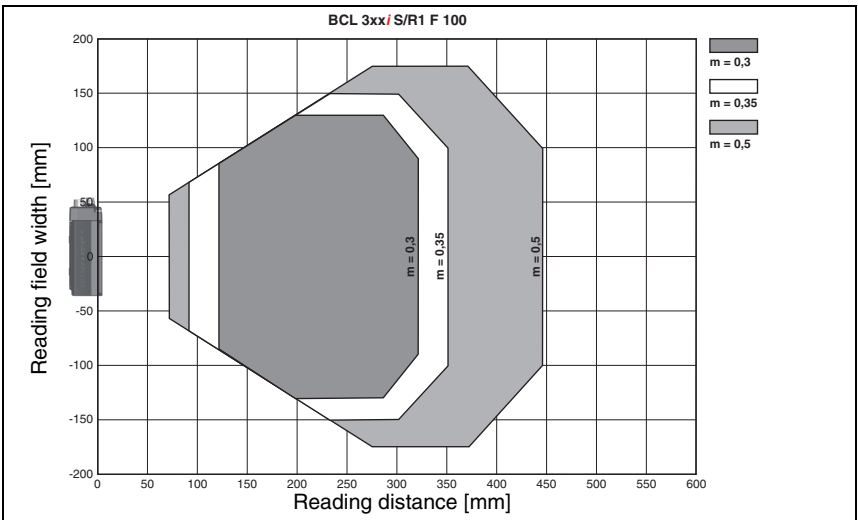

Figure 5.15: "Low Density" reading field curve for line scanner with deflection mirror

The reading field curves apply for the reading conditions stated in table 5.8.

5.5.8 Low Density (F) - optics: BCL 358*i* OF 100 (H)

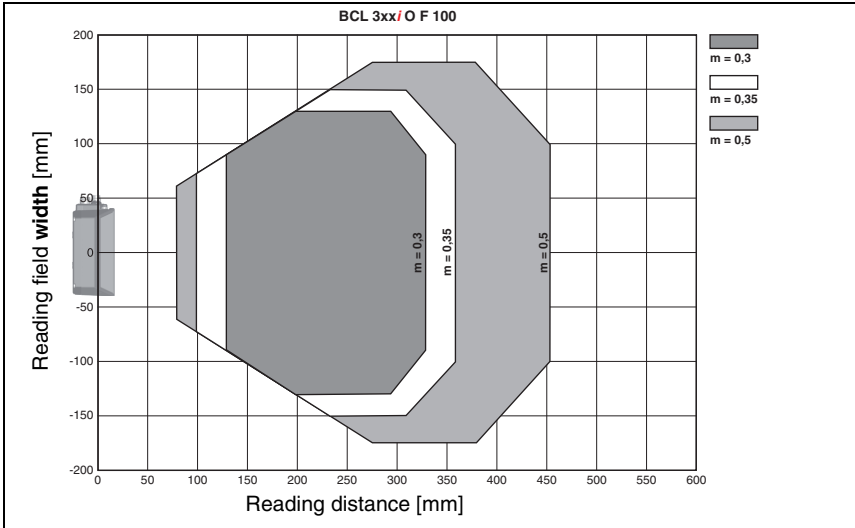

Figure 5.16: "Low Density" reading field curve for oscillating-mirror scanners

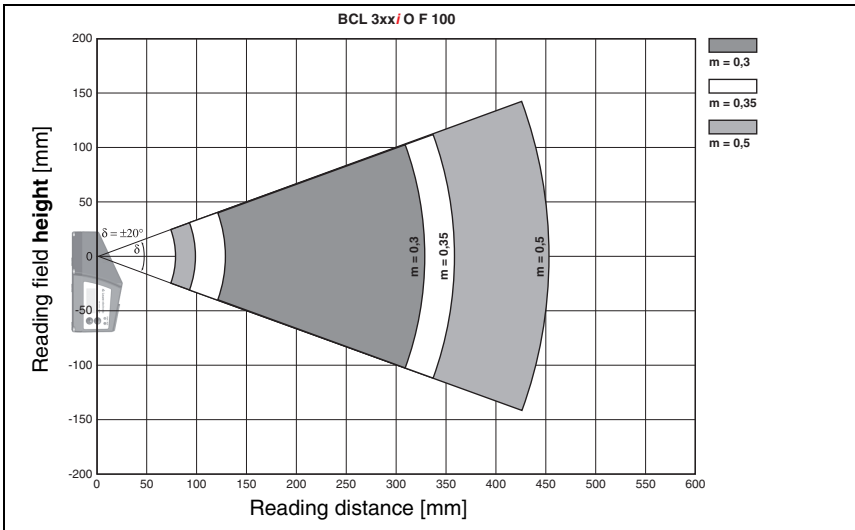

Figure 5.17: Lateral "Low Density" reading field curve for oscillating-mirror scanners

The reading field curves apply for the reading conditions stated in table 5.8.

5.5.9 Ultra Low Density (L) - optics: BCL 358*i* S L 102 (H)

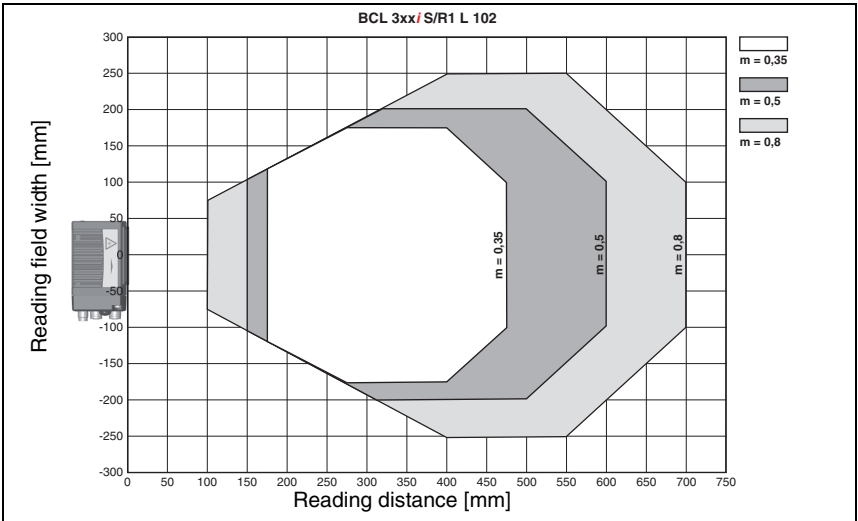

Figure 5.18: "Ultra Low Density" reading field curve for line scanner without deflection mirror

5.5.10 Ultra Low Density (L) - optics: BCL 358*i* S L 100 (H)

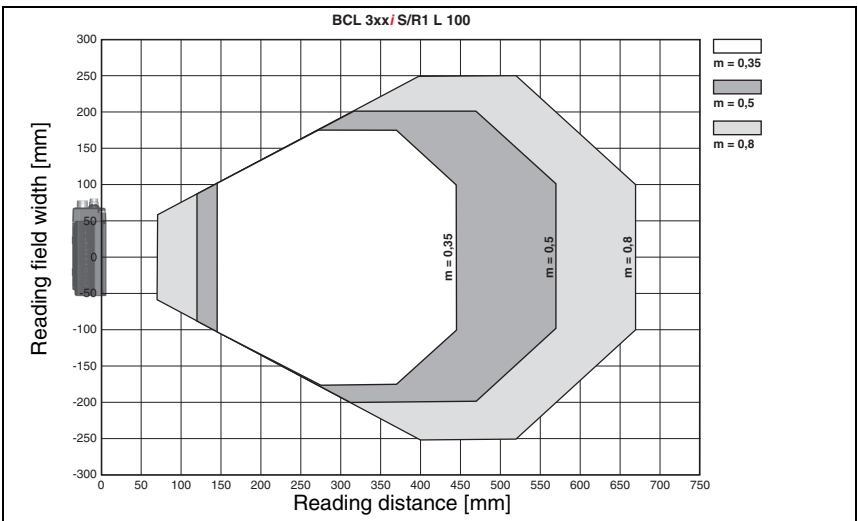

Figure 5.19: "Ultra Low Density" reading field curve for line scanner with deflection mirror

The reading field curves apply for the reading conditions stated in table 5.8.

5.5.11 Ultra Low Density (L) - optics: BCL 358*i* OL 100 (H)

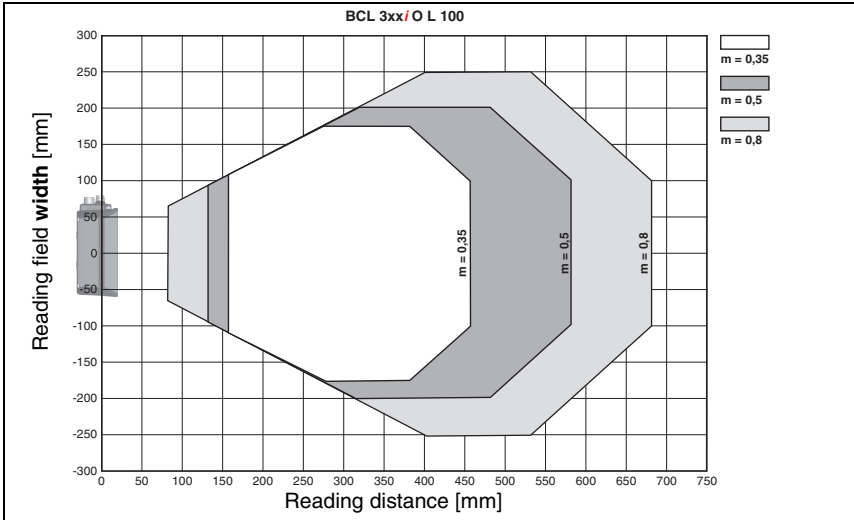

Figure 5.20: "Ultra Low Density" reading field curve for oscillating-mirror scanners

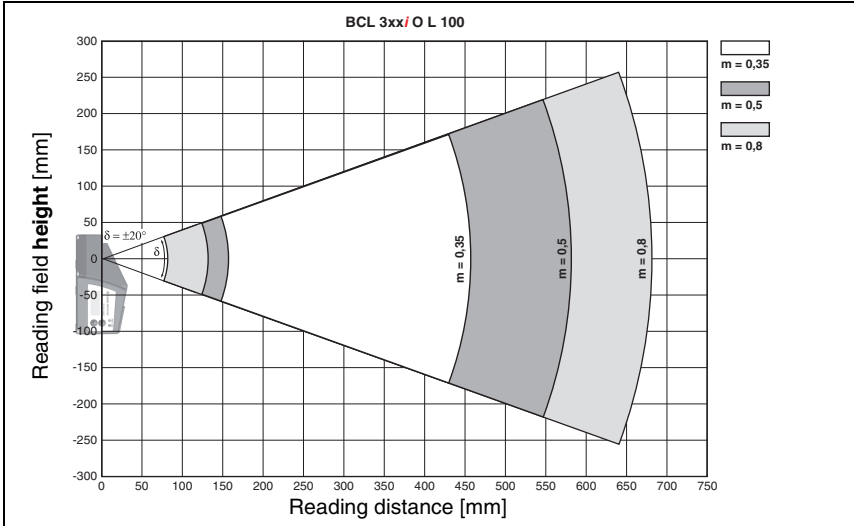

Figure 5.21: Lateral "Ultra Low Density" reading field curve for oscillating-mirror scanners

The reading field curves apply for the reading conditions stated in table 5.8.

6 Installation and mounting

6.1 Storage, transportation



Attention!

When transporting or storing, package the device so that it is protected against collision and humidity. Optimum protection is achieved when using the original packaging. Heed the required environmental conditions specified in the technical data.

Unpacking

- ↳ Check the packaging for any damage. If damage is found, notify the post office or shipping agent as well as the supplier.
- ↳ Check the delivery contents using your order and the delivery papers:
 - Delivered quantity
 - Device type and model as indicated on the name plate
 - Laser warning signs
 - Brief manual

The name plate provides information as to what BCL type your device is. For specific information, please refer to chapter 5.

Name plates of the bar code readers of the BCL 358i series

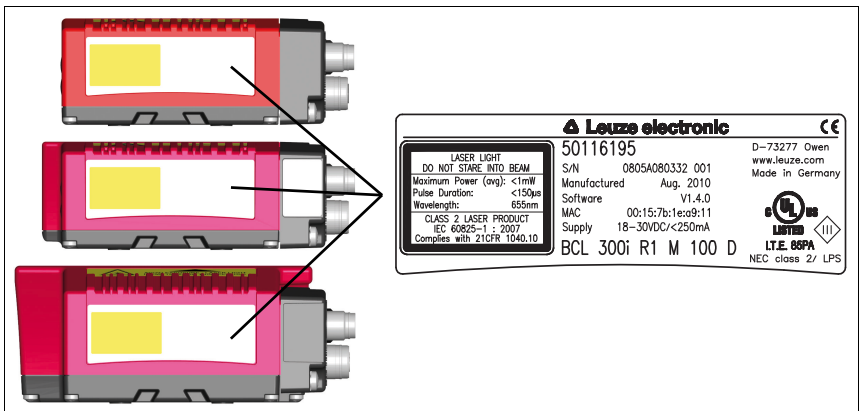

Figure 6.1: Device name plate BCL 358i

- ↳ Save the original packaging for later storage or shipping.



Notice!

All BCL 358i are delivered with a protective cover on the connection side which must be removed before attaching a connection hood.

If you have any questions concerning your shipment, please contact your supplier or your local Leuze electronic sales office.

 Observe the applicable local regulations when disposing of the packaging materials.

6.2 Mounting the BCL 358*i*

The BCL 358*i* bar code readers can be mounted in two different ways:

- Via four or six M4x5 screws on the bottom of the device.
- Via a BT 56 mounting device in the two fastening grooves on the bottom of the device.



Attention!

The BCL 300*i* does not fulfill protection class IP 65 until the connection hood has been screwed on. Minimum tightening torque of the housing connection screws on the connection hood 1.4Nm!

6.2.1 Fastening with M4 x 5 screws

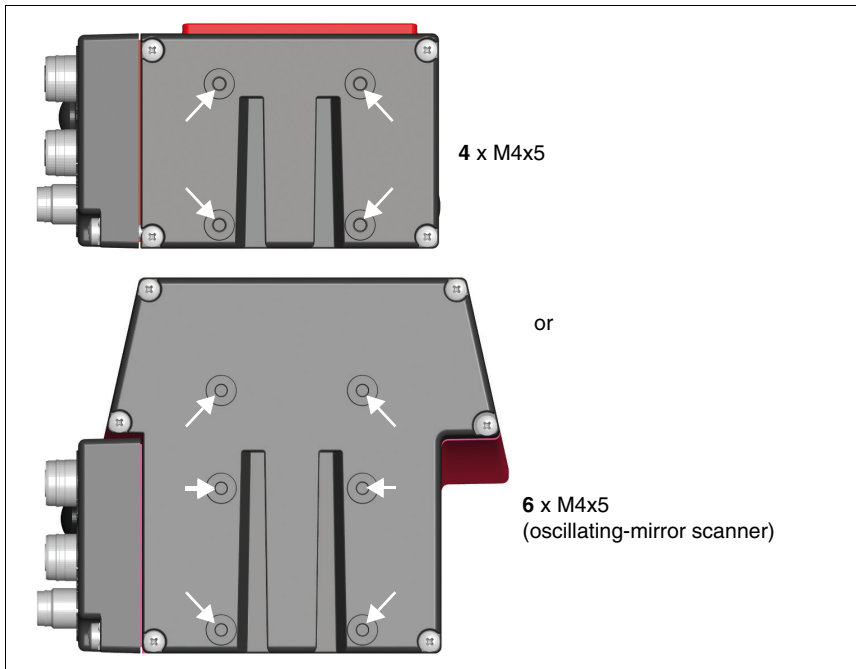

Figure 6.2: Fastening options using M4x5 threaded holes

6.2.2 BT 56 mounting device

The BT 56 mounting device is available for mounting the BCL 358*i* using the fastening grooves. It is designed for rod mounting (Ø 16mm to 20mm). For ordering instructions, please refer to chapter "Type overview and accessories" on page 157.

BT 56 mounting device

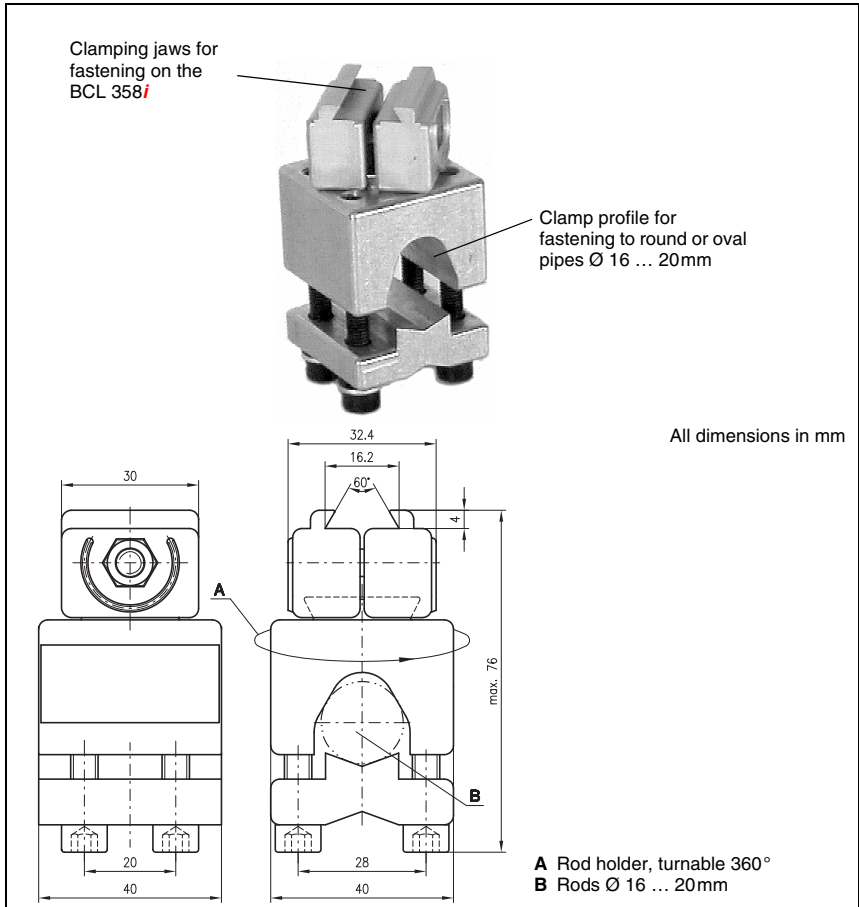

Figure 6.3: BT 56 mounting device

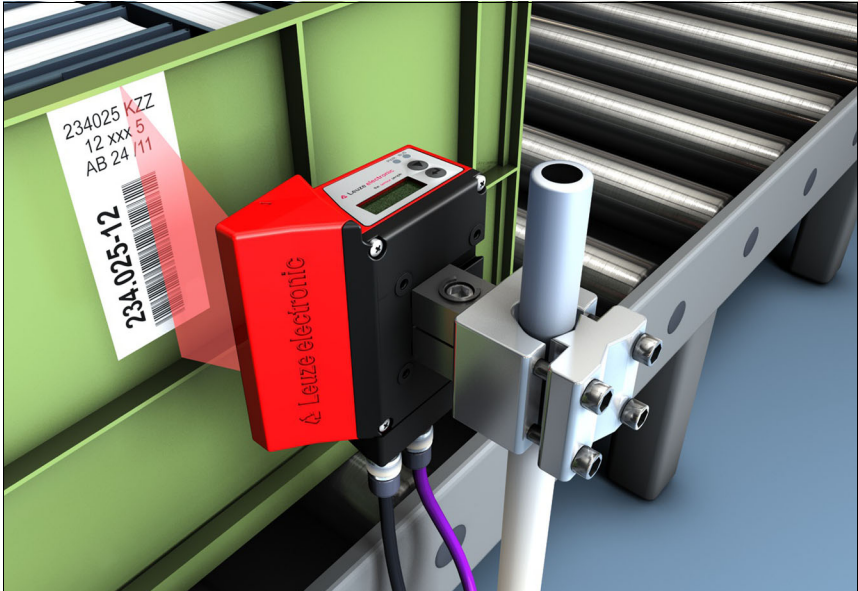

Figure 6.4: Mounting example of BCL 358*i* with BT 56

6.2.3 BT 59 mounting device

The BT 59 mounting device offers you an additional fastening option. For ordering instructions, please refer to chapter "Type overview and accessories" on page 157.

BT 59 mounting device

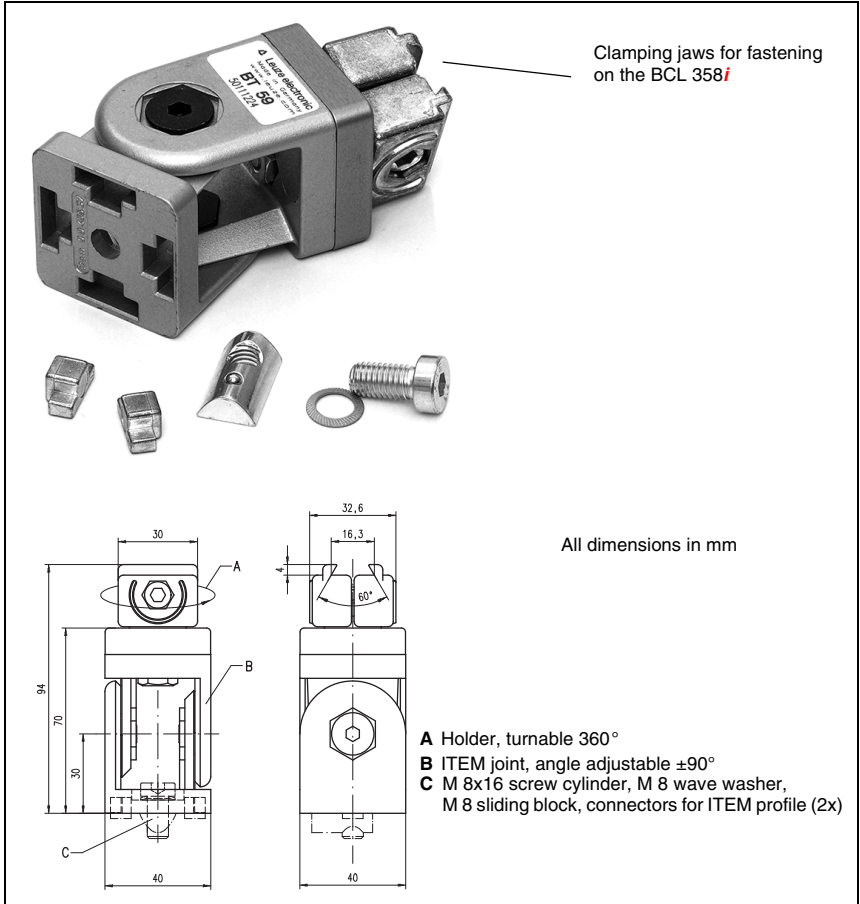

Figure 6.5: BT 59 mounting device



Notice!

When mounting, ensure that the scanning beam is not reflected directly back to the scanner by the label which is being read. For further information, see the notices in chapter 6.3! Please refer to chapter 5.4 for the permissible minimum and maximum distances between the BCL 358*i* and the labels to be read.

6.3 Device arrangement

6.3.1 Selecting a mounting location

In order to select the right mounting location, several factors must be considered:

- Size, orientation, and position tolerance of the bar codes on the objects to be scanned.
- The reading field of the BCL 358*i* in relation to the bar code module width.
- The resulting minimum and maximum reading distance from the respective reading field (see chapter 5.4 "Reading field curves / optical data").
- The permissible cable lengths between the BCL 358*i* and the host system depending on which interface is used.
- The correct time for data output. The BCL 358*i* should be positioned in such a way that, taking into consideration the time required for data processing and the conveyor belt speed, there is sufficient time to e.g. initiate sorting operations on the basis of the read data.
- The display elements such as LEDs or the display should be highly visible.
- For configuring and commissioning with the webConfig tool, the USB interface should be easily accessible.

For specific information, please refer to chapter 6 and chapter 7.



Notice!

*The beam of the BCL 358*i* exits:*

- **parallel** to the **housing base** in the case of the line scanner
- at **105 degrees** from the **housing base** in the case of the deflection mirror
- **perpendicular** to the **housing base** in the case of the oscillating mirror

In each case, the housing base is the black area in figure 6.2. The best read results are obtained when:

- The BCL 358*i* is mounted in such a way that the scanning beam is incident on the bar code at an angle of inclination greater than $\pm 10^\circ$... 15° to vertical.
- The reading distance lies in the middle area of the reading field.
- *The bar code labels are of good print quality and have good contrast ratios.*
- You do not use high-gloss labels.
- *There is no direct sunlight.*

6.3.2 Avoiding total reflection – line scanner

The bar code label must be positioned at an angle of inclination greater than $\pm 10^\circ \dots 15^\circ$ from vertical in order to avoid total reflection of the laser beam (see figure 6.6)!

Total reflection occurs whenever the laser light of the bar code reader is directly incident on the surface of the bar code at an angle of 90° . The light directly reflected by the bar code may overload the bar code reader and thereby cause non-readings!

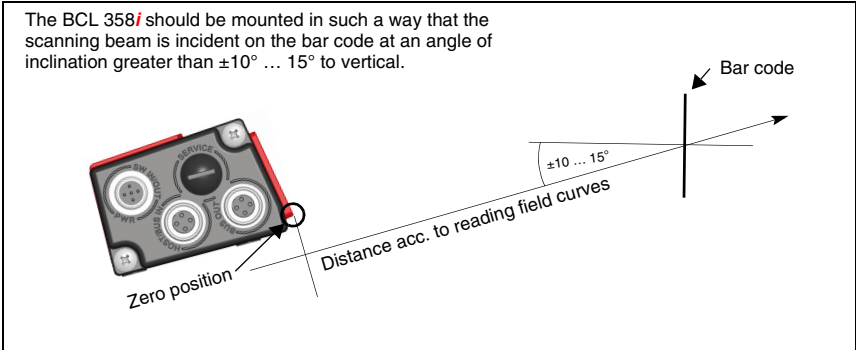

Figure 6.6: Total reflection – line scanner

6.3.3 Avoiding total reflection – deflection mirror scanner

For the BCL 358*i* with **deflection mirror**, the laser beam exits at an angle of 105° to the rear housing wall.

An angle of incidence of 15° of the laser to the label has already been integrated in the deflection mirror so that the BCL 358*i* can be installed parallel to the bar code (rear housing wall).

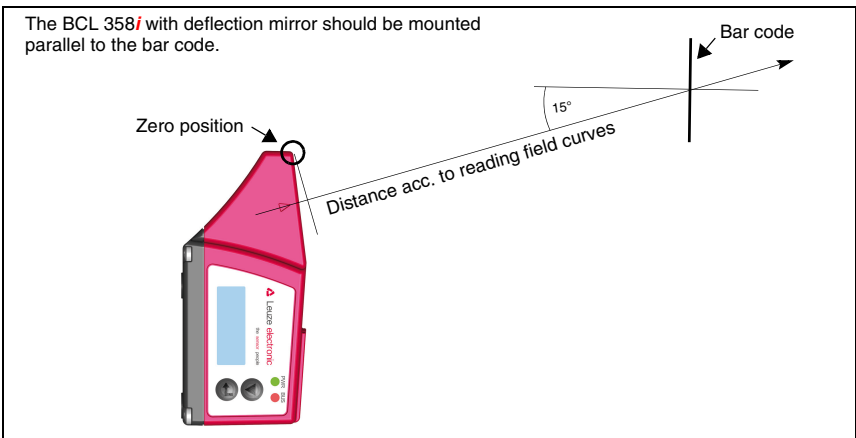

Figure 6.7: Total reflection – line scanner

6.3.4 Avoiding total reflection – oscillating-mirror scanner

For the BCL 358*i* with **oscillating mirror**, the laser beam exits at an angle of **90° to vertical**.

For the BCL 358*i* with **oscillating mirror**, the **swivel range of ±20°** (±12° for devices with heating) **is to be taken into account**.

This means that in order to be on the safe side and to avoid total reflection, the BCL 358*i* with oscillating mirror must be inclined upward or downward 20° ... 30°!



Notice!

Mount the BCL 358*i* with oscillating mirror in such a way that the outlet window of the bar code reader is parallel to the object. This will result in an angle of inclination of approx. 25°.

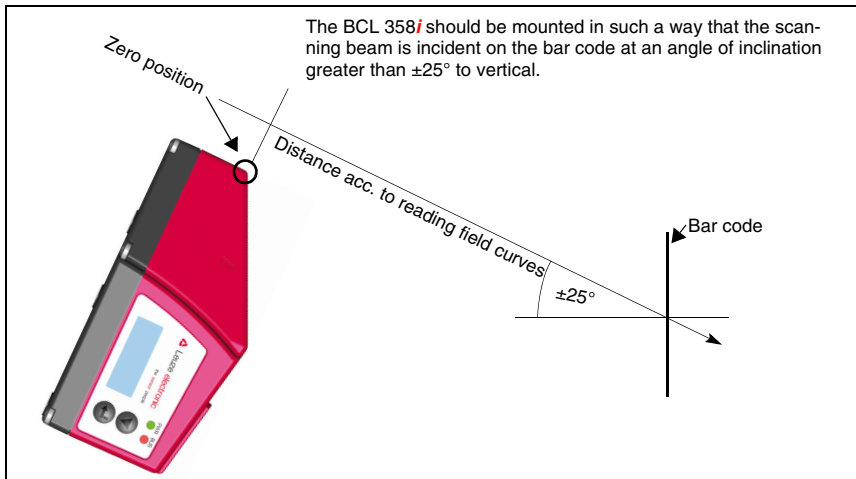

Figure 6.8: Total reflection – BCL 358*i* with oscillating mirror

6.3.5 Mounting location

↳ When selecting a mounting location, pay attention to:

- Maintaining the required environmental conditions (temperature, humidity).
- Possible soiling of the reading window due to liquids, abrasion by boxes, or packaging material residues.
- Lowest possible chance of damage to the BCL 358*i* by mechanical collision or jammed parts.
- Possible extraneous light (no direct sunlight or sunlight reflected by the bar code).

6.3.6 Devices with integrated heating

↳ For devices with integrated heating, also observe the following points:

- Mount the BCL 358*i* in a way which provides maximum thermal isolation, e.g. using rubber-bonded metal.
- Mount in such a way that the device is protected from draft and wind; mount additional shields if necessary.



Notice!

When installing the BCL 358*i* in a protective housing, it must be ensured that the scanning beam can exit the protective housing without obstruction.

6.3.7 Possible reading angles between BCL 358*i* and bar code

The optimum alignment of the BCL 358*i* is accomplished when the scan line scans the code bars almost at a right angle (90°). All reading angles that are possible between the scan line and bar code must be taken account (figure 6.9).

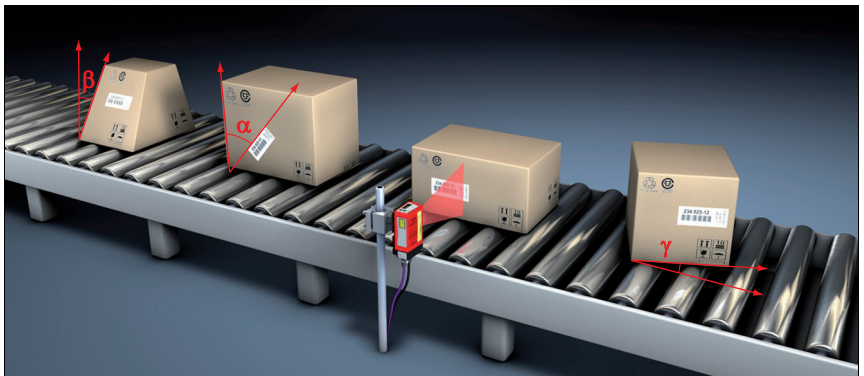

Figure 6.9: Reading angle for the line scanner

α Tilt

β Angle of inclination (Pitch)

γ Skew

In order to avoid total reflection, the skew γ should be greater than 10°.

6.4 Cleaning

- ↳ Clean the glass pane of the BCL 358*i* with a soft cloth after mounting. Remove all packaging remains, e.g. carton fibers or Styrofoam balls. In doing so, avoid leaving fingerprints on the front cover of the BCL 358*i*.



Attention!

Do not use aggressive cleaning agents such as thinner or acetone for cleaning the device.

7 Electrical connection

The bar code readers in the BCL 300*i* series feature a modular connection concept with interchangeable connection hoods.

The additional Mini-B type USB interface is used for configuring the device.



Notice!

On delivery, the products are provided with a plastic protective cap on the side of the system plug or the system socket.

Additional connection accessories can be found in chapter 13.



Attention!

*The BCL 358*i* does not fulfill protection class IP 65 until the connection hood has been screwed on. Minimum tightening torque of the housing connection screws on the connection hood 1.4Nm!*

Location of the electrical connections

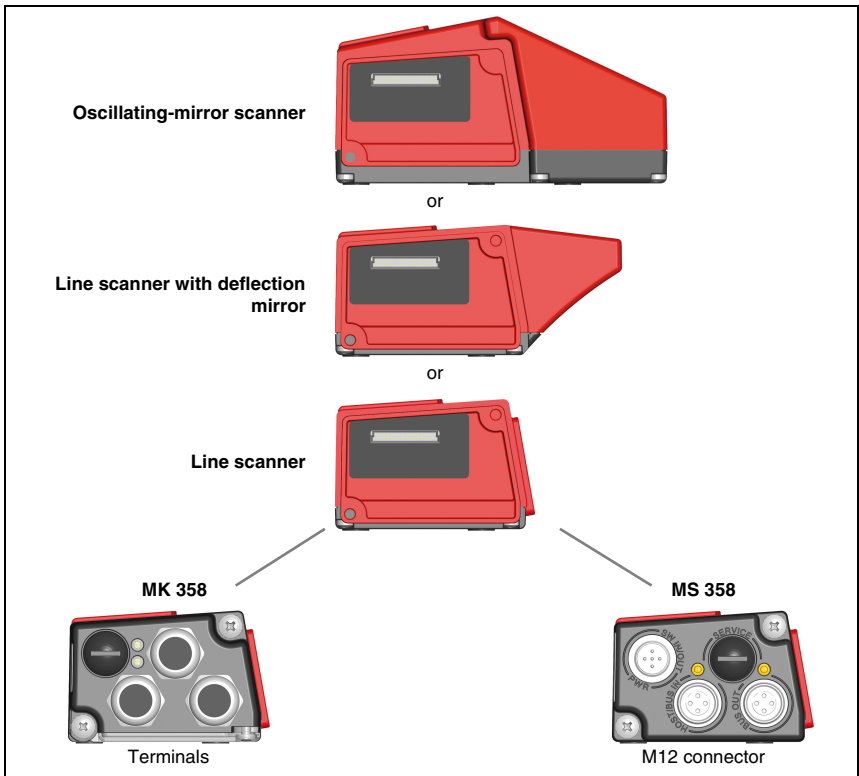

Figure 7.1: Location of the electrical connections

7.1 Safety notices for the electrical connection

**Attention!**

*Do not open the device yourself under any circumstances! There is otherwise a risk of uncontrolled emission of laser radiation from the device. The housing of the BCL 358*i* contains no parts that need to be adjusted or maintained by the user.*

Before connecting the device, be sure that the supply voltage agrees with the value printed on the name plate.

Connection of the device and cleaning must only be carried out by a qualified electrician.

Ensure that the functional earth (FE) is connected correctly. Unimpaired operation is only guaranteed when the functional earth is connected properly.

If faults cannot be corrected, the device should be removed from operation and protected against possible commissioning.

**Attention!**

For UL applications, use is permitted exclusively in Class 2 circuits according to NEC (National Electric Code).



*The bar code readers of the BCL 300*i* series are designed in accordance with safety class III for supply by PELV (protective extra-low voltage).*

**Notice!**

Protection class IP 65 is not fulfilled until connectors or cable lead-throughs are screwed on and caps are installed!

**Attention!**

To ensure protection class IP 65 is fulfilled, the screws of the connection hood are tightened with a tightening torque of 1.4Nm for connecting to the BCL.

7.2 Electrical connection BCL 358*i*

For the electrical connection of the BCL 358*i*, 2 connection variants are available.

The **voltage supply** (18 ... 30VDC) is connected acc. to the connection type selected.

2 freely programmable switching inputs/outputs for individual adaptation to the respective application are also available here. Detailed information on this topic can be found in chapter 7.3.1.

7.2.1 MS 358 connector hood with 3 integrated M12 connectors

The MS 358 connector hood features three M12 connector plugs and a Mini-B type USB socket as a service interface. Parameter memory is integrated into the MS 358 which temporarily stores the settings of the BCL 358*i* in the case of replacement and transmits them to a new device.

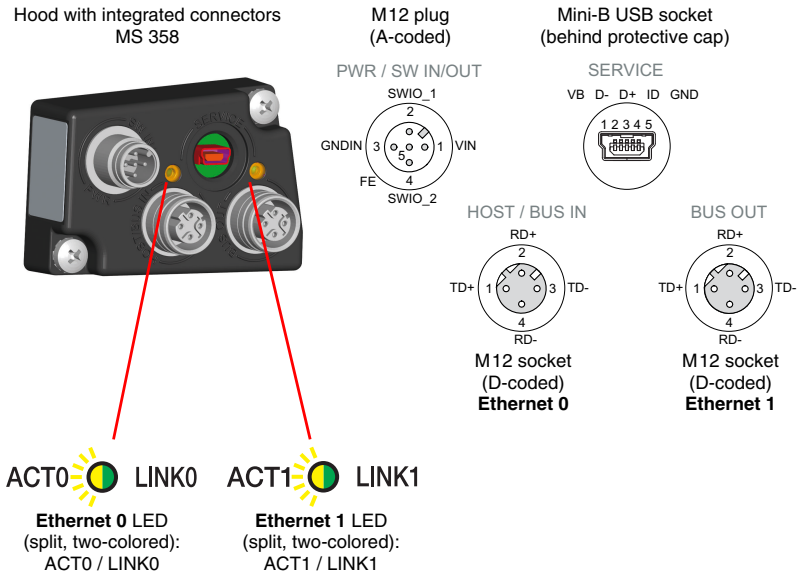

Figure 7.2: BCL 358*i* - MS 358 connector hood with M12 connectors



Notice!

The shielding connection is done via the M12 connector housing.

Notice!

The integrated parameter memory for the simple replacement of the BCL 358*i* is located in the MS 358. In the integrated parameter memory, both the settings and the network address are saved and transmitted to a new device.



Notice!

In the case of Ethernet line topology, the network is interrupted when the BCL 358*i* is removed from the MS 358.



Notice!

See chapter 5.3.5 "Dimensioned drawing of MS 3xx connector hood / MK 3xx terminal hood" dimensioned drawing on page 48.

7.2.2 MK 358 terminal hood with spring-loaded terminals

The MK 358 terminal hood makes it possible to connect the BCL 358*i* directly and without additional connectors. The MK 358 features three cable lead-throughs in which the shielding connection for the interface cable is also located. The BCL 358*i* is also to be configured when the MK 358 is in a closed state via a Mini-B type USB socket functioning as the service interface. Parameter memory is integrated into the MK 358 which temporarily stores the settings of the BCL 358*i* in the case of replacement and transmits them to a new device.

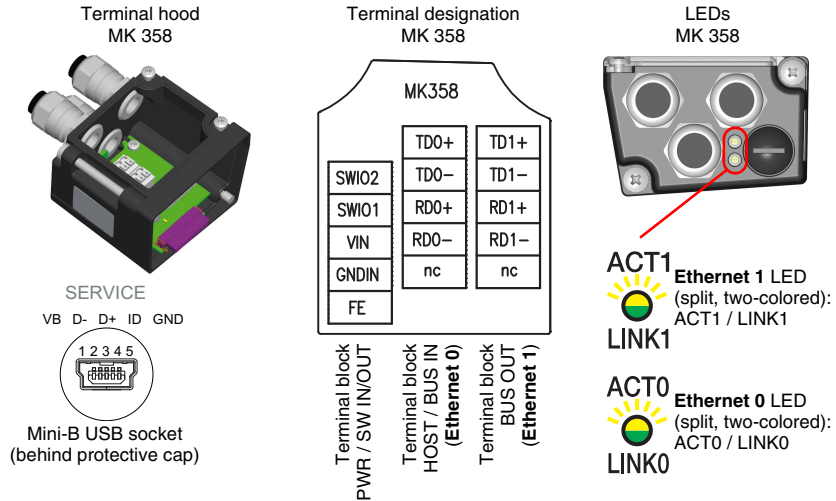

Figure 7.3: BCL 358*i* - MK 358 terminal hood with spring-loaded terminals



Notice!

The integrated parameter memory for simple exchange of the BCL 358*i* is located in the MK 358. In the integrated parameter memory, both the settings and the network address are saved and transmitted to a new device.



Notice!

In the case of Ethernet line topology, the network is interrupted when the BCL 358*i* is removed from the MK 358.

Cable fabrication and shielding connection

Remove approx. 78 mm of the connection cable sheathing. 15 mm of sheath of the shielded line must be freely accessible.

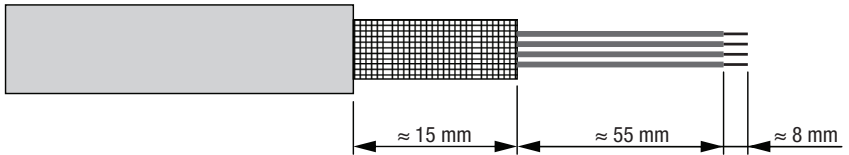

Figure 7.4: Cable fabrication for MK 358 terminal hood

The shield is automatically contacted when the cable is lead into the metal screw fitting and fastened when the cord grip is closed. Then lead the individual wires into the terminals according to the diagram. Wire end sleeves are not necessary.



Notice!

See chapter 5.4 "Reading field curves / optical data" dimensioned drawing on page 49.

7.3 Detailed description of the connections

Described in detail in the following are the individual connections and pin assignments.

7.3.1 PWR / SW IN/OUT - Voltage supply and switching input/outputs 1 and 2

PWR / SW IN/OUT			
	Pin (M12)	Name (terminal)	Remark
 <p>MS 358 PWR / SW IN/OUT</p> <p>M12 plug (A-coded)</p>	1	VIN	Positive supply voltage +18 ... +30VDC
	2	SWIO_1	Configurable switching input / output 1
	3	GNDIN	Negative supply voltage 0VDC
	4	SWIO_2	Configurable switching input / output 2
	5	FE	Functional earth
 <p>MK 358</p> <p>Spring-loaded terminals</p>	Thread	FE	Functional earth (housing)

Table 7.1: Pin assignment PWR / SW IN/OUT

Supply voltage

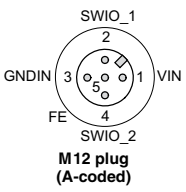
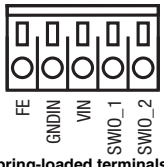

Attention!

For UL applications, use is permitted exclusively in Class 2 circuits according to NEC (National Electric Code).



The bar code readers of the BCL 300*i* ... series are designed in accordance with safety class III for supply by PELV (protective extra-low voltage).

Connecting functional earth FE

⚡ Ensure that the functional earth (FE) is connected correctly. Unimpaired operation is only guaranteed when the functional earth is connected properly. All electrical disturbances (EMC couplings) are discharged via the functional earth connection.

Switching input / output

The bar code readers of the BCL 300*i* series are equipped with two freely programmable, opto-decoupled switching inputs and outputs, **SWIO_1** and **SWIO_2**.

The switching inputs can be used to activate various internal functions of the BCL 358*i* (decoding, autoConfig, ...). The switching outputs can be used to signal the state of the BCL 358*i* and to implement external functions independent of the superior control.



Notice!

The respective function as input or output can be set with the aid of the webConfig configuration tool!

Described in the following is the external wiring for use as a switching input or output; the respective function assignments to the switching inputs/outputs can be found in chapter 10.

Function as switching input

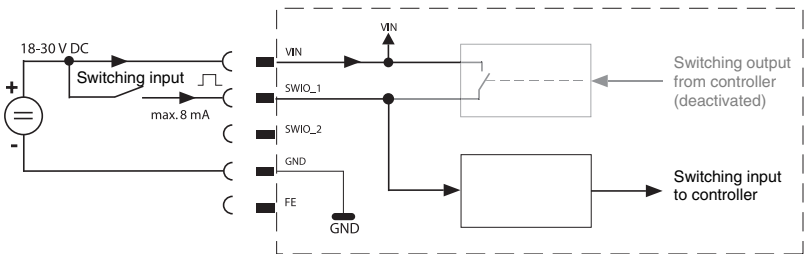

Figure 7.1: Switching input connection diagram SWIO_1 and SWIO_2

If you use a sensor with a standard M12 connector, please note the following:

- Pins 2 and 4 must not be operated as switching outputs if sensors which function as inputs are also connected to these pins.

If, for example, the inverted sensor output is connected to pin 2, and pin 2 of the bar code reader is, at the same time, configured as an output (and not as an input), the switching output malfunctions.



Attention!

The maximum input current must not exceed 8mA!

Function as switching output

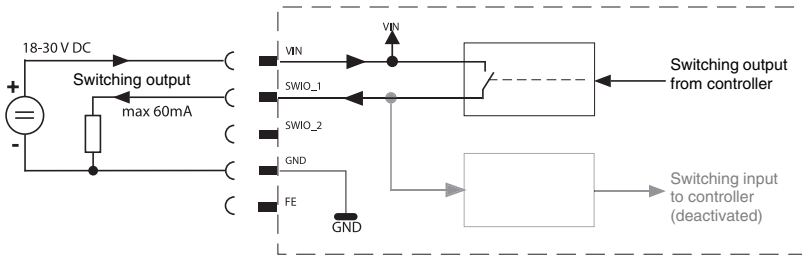

Figure 7.2: Switching output connection diagram SWIO_1 / SWIO_2



Attention!

Each configured switching output is short-circuit proof! Do not load the respective switching output of the BCL 358*i* with more than 60mA at +18 ... +30 VDC in normal operation!



Notice!

Both switching inputs/outputs SWIO_1 and SWIO_2 are configured by default in such a way that:

- Switching input SWIO_1 activates the reading gate.
- Switching output SWIO_2 switches by default on "No Read."

7.3.2 SERVICE – USB interface (Mini-B type)

SERVICE – USB interface (Mini-B type)			
	Pin (USB Mini-B)	Name	Remark
<p>SERVICE</p> <p>VB D- D+ ID GND</p> 	1	VB	Sense input
	2	D-	Data -
	3	D+	Data +
	4	ID	Not connected
	5	GND	Ground

Table 7.2: Pin assignment SERVICE – Mini-B type USB interface

⚡ Ensure adequate shielding.

The entire connection cable must absolutely be shielded acc. to the USB specifications. Cable length must not exceed 3m.

⚡ Use the Leuze specific **USB service cable** (See chapter 13 "Type overview and accessories") for the connection and use a service PC to configure.



Notice!

IP 65 is achieved only if the connectors and caps are screwed into place.

7.3.3 HOST / BUS IN for BCL 358*i*

The BCL 358*i* makes either the Ethernet interface available as host interface.



HOST / BUS IN Ethernet_0 (4-pin socket, D-coded)			
MS 358 HOST / BUS IN	Pin (M12)	Name (terminal)	Remark
 <p>RD0+ 2 TD0+ 1 3 TD0- RD0- 4</p> <p>M12 socket (D-coded)</p> <p>MK 358</p>  <p>n.c. RD0- RD0+ TD0- TD0+ Spring-loaded terminals</p>	1	TD0+	Transmit Data +
	2	RD0+	Receive Data +
	3	TD0-	Transmit Data -
	4	RD0-	Receive Data -
	FE via thread	FE via screw fitting	Functional earth (housing)

Table 7.3: Pin assignment HOST / BUS IN BCL 358*i*

↳ For the host connection of the BCL 358*i*, the "KB ET - ... - SA-RJ45" ready-made cables are preferred, see table 13.10 "Bus connection cables for the BCL 358*i*" on page 162.

Ethernet cable assignments

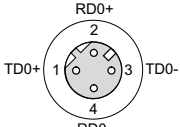
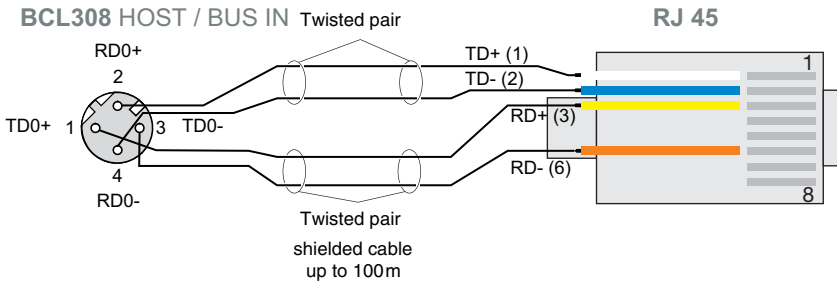

Figure 7.3: HOST / BUS IN cable assignments on RJ-45



Notice for connecting the Ethernet interface!

Ensure adequate shielding. The entire connection cable must be shielded and earthed. The RD+/RD- and TD+/TD- wires must be stranded in pairs. Use CAT 5 cable for the connection.

7.3.4 BUS OUT for the BCL 358*i*

To set up an Ethernet network with other participants with linear topology, the BCL 358*i* makes available another Ethernet interface. The use of this interface drastically reduces the cabling requirements, as only the first BCL 358*i* requires a direct connection to the switch, via which it can communicate with the host. All other BCL 358*i* are connected in series to the first BCL 358*i*, see figure 7.5.

BUS OUT Ethernet_1 (4-pin socket, D-coded)			
	Pin (M12)	Name (terminal)	Remark
<p>MS 358 BUS OUT</p> <p>RD1+ 2 TD1+ 1 3 TD1- RD1- 4</p> <p>M12 socket (D-coded)</p> <p>MK 358</p> <p>n.c. RD1- RD1+ TD1- TD1+</p> <p>Spring-loaded terminals</p>	1	TD1+	Transmit Data +
	2	RD1+	Receive Data +
	3	TD1-	Transmit Data -
	4	RD1-	Receive Data -
	FE via thread	FE via screw fitting	Functional earth (housing)

Table 7.4: Pin assignment BUS OUT BCL 358*i*

↳ For the connection of two BCL 358*i*, the "KB ET - ... - SSA" ready-made cables are preferred, see table 13.10 "Bus connection cables for the BCL 358*i*" on page 162.

If you use user-configurable cables, note the following:



Notice!

Ensure adequate shielding. The entire connection cable must be shielded and earthed. The signal lines must be stranded in pairs. Use CAT 5 cable for the connection.



Notice!

For the BCL 358*i* as standalone device or as the last participant in a linear topology, termination on the BUS OUT socket is not mandatory!

7.4 Ethernet topologies

The BCL 358*i* can be operated as a single device (stand-alone) in an Ethernet star topology with individual IP address.

The address can either be manually set permanently via the BootP/webConfig tool or assigned dynamically via a DHCP server.

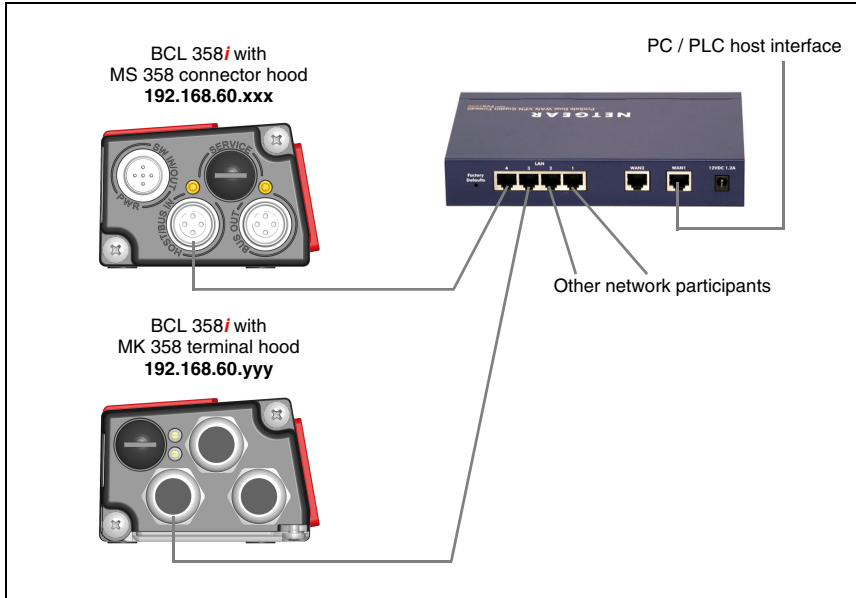

Figure 7.4: Ethernet with star topology

The innovative further development of the BCL 358*i* with integrated switch functionality offers the option of networking multiple bar code readers of type BCL 358*i* with one another. In addition to the classic "star topology", a "linear topology" is thus also possible.

This makes wiring the network easy and inexpensive as slaves are looped through to one another in parallel.

The maximum length of a segment (connection between two switches/BCL 358*i*) is limited to 100m.

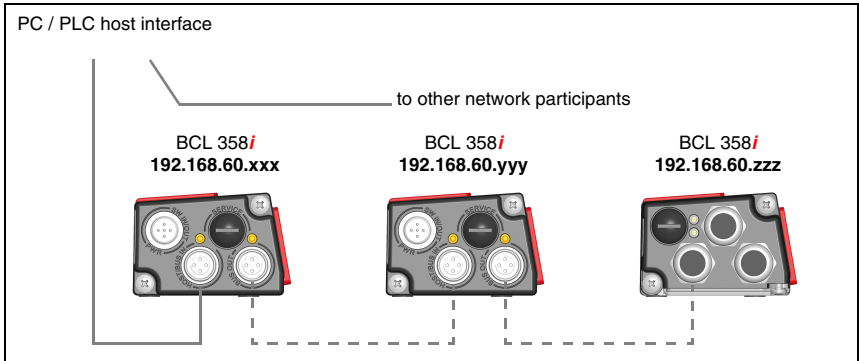

Figure 7.5: Ethernet with linear topology

Each participating BCL 358*i* is automatically assigned its address by a DHCP server. Alternatively, each BCL 358*i* can be assigned the respective network address via the webConfig tool. This address must be specified by the network administrator. Information on the necessary configuration steps can be found in chapter 10.

7.4.1 Ethernet wiring

A Cat. 5 Ethernet cable should be used for wiring.

For the connection on the BCL 358*i*, a "KDS ET M12 / RJ 45 W - 4P" adapter is available into which the standard network cable can be plugged.

If no standard network cables are to be used (e.g. due to lacking IP... protection class), you can use the "KB ET - ... - SA" user-configurable cable on the BCL 358*i*, see table 13.10 "Bus connection cables for the BCL 358*i*" on page 162.

The individual BCL 358*i* devices in a linear topology are connected with the "KB ET - ... - SSA" cable, see table 13.10 "Bus connection cables for the BCL 358*i*" on page 162.

For unavailable line lengths, you can configure your cables yourself. When doing so, make certain that you connect **TDx+** on the M12 connector with **RD+** on the RJ-45 connector and **TDx-** on the M12 connector with **RD-** on the RJ-45 connector, respectively, etc.



Notice!

Use the recommended connectors / sockets or the ready-made cables (See chapter 13 "Type overview and accessories").

7.5 Cable lengths and shielding

↳ Observe the following maximum cable lengths and shielding types:

Connection	Interface	Max. cable length	Shielding
BCL – service	USB	3m	shielding absolutely necessary acc. to USB specifications
BCL – host	EtherNet	100m	absolutely required, shielded
Network from the first BCL to the last BCL	EtherNet	The max. segment length must not exceed 100m for 10Base-T twisted pairs (min. Cat. 3) and 100Base-TX twisted pair (min. Cat. 5)	absolutely required, shielded
BCL – power supply unit		30m	not necessary
Switching input		10m	not necessary
Switching output		10m	not necessary

Table 7.5: Cable lengths and shielding

8 Display elements and display

The BCL 358*i* is available optionally with display, two control buttons and LEDs or with only two LEDs as display elements.

8.1 LED indicators BCL 358*i*



Figure 8.1: BCL 358*i* - LED indicators

Two multicolor LEDs are used as the primary display instrument. LED functions:

PWR LED

PWR



off

Device OFF

- no supply voltage

PWR



flashes green

Device ok, initialization phase

- no bar code reading possible
- voltage connected
- self test runs for 0.25s after power up
- initialization running

PWR



green continuous light

Device ok

- bar code reading possible
- self test successfully finished
- device monitoring active

PWR



green, briefly off - on

Good read, successful reading

- bar code(s) successfully read



green, briefly off - briefly red - on **No read, reading not successful**
 - bar code(s) not read



orange continuous light **Service mode**
 - bar code reading possible
 - configuration via the USB service interface
 - no data on the host interface



flashing red **Warning set**
 - bar code reading possible
 - self test runs for 0.25s after power up
 - temporary operating fault



red continuous light **Device error**
 - no bar code reading possible

NET LED



off **NET LED off**
 - no voltage supply
 - no IP address assigned



flashing green **NET LED flashes green**
 - LED self test runs for 0.25s after power up
 - no EtherNet/IP communication present
 - BCL 358*i* is not assigned to any master



green continuous light **NET LED green**
 - BCL 358*i* bus communication ok



red flashing **NET LED flashes red**
 - LED self test runs for 0.25s after power up
 - time-out in bus communication



red continuous light **NET LED red**
 - double IP address



green/red flashing **NET LED flashes green/red**
 - self test

8.2 MS 358/MK 358 LED indicators

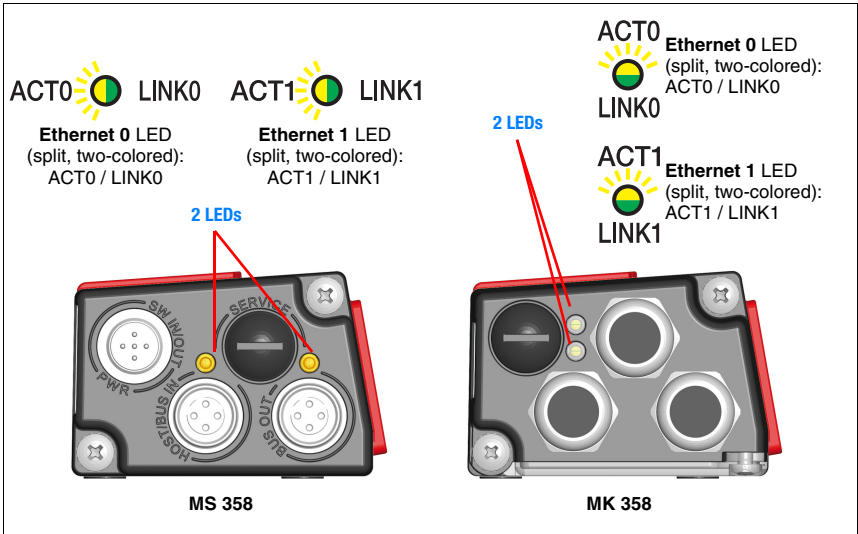

Figure 8.2: MS 358/MK 358 - LED indicators

As a status display for the two Ethernet connections, **Ethernet_0** and **Ethernet_1**, there are two split two-colored LEDs each in the MS 358 and MK 358:

LED ACT0 / LINK0 (on the MS 358/MK 358)

	<p>green continuous light yellow flashing</p>	<p>Ethernet connected (LINK) Data communication (ACT)</p>
---	---	---

LED ACT1 / LINK1 (on the MS 358/MK 358)

	<p>green continuous light yellow flashing</p>	<p>Ethernet connected (LINK) Data communication (ACT)</p>
---	---	---

8.3 Display BCL 358*i*



Figure 8.3: BCL 358*i* - Display



Notice!

The function of the LEDs is identical for the devices with and without display.

The optional display of the BCL 358*i* has the following features:

- Monochromatic with background lighting (blue/white)
- Double line, 128 x 32 pixels
- Display language: English

The display is only used as a **display element**. Two buttons can control which values are displayed. In doing so, the upper line displays the selected function and the lower line displays the result.

The background lighting is activated by the push of any button and automatically deactivated after a defined point in time:

Display functions

The following functions can be displayed and activated:

- Reading result = result of reading process
- Decodequality = quality of decoding process
- BCL Info = device status/error code
- I/O Status = status of the in/outputs
- BCL Address = IP address of the BCL 358*i*
- Adjustmode = alignment mode
- Version = software and hardware version

After the voltage is switched off/on, `reading result` is always displayed. The display is controlled via the two control buttons:



ENTER

Activate/deactivate the display change function







Down

Scroll through functions (downwards)

Example:

Representation of the `BUS status` on the display:

1. Press button : display flashes
2. Press button : display changes from read result to decoding quality
3. Press button : display changes from decoding quality to device status
4. Press button : display changes from device status to BUS status
5. Press button : bus status is displayed, display stops flashing

Description of the display functions

```
Reading result
88776655
```

- 1st line: **read result** display function
- 2nd line: code content of the bar code, e.g. **88776655**

```
Decoding quality
84
```

- 1st line: **decoding quality** display function
- 2nd line: decoding quality in percent, e.g. **84%**

```
BCL info
Error code 3201
```

- 1st line: **device status** display function
- 2nd line: error code, e.g. **Error code 3201**

```
I/O status
In = 0 Out = 1
```

- 1st line: input/output **state** display function
- 2nd line: state: 0 =inactive, 1 = active, e.g. **In=0, Out=1**

```
BCL address
192.168.060.0
```

- 1st line: **IP address** display function
- 2nd line: set address, e.g. **192.168.060.0**

```
Adjust mode
73
```

- 1st line: **alignment mode** display function
- 2nd line: decoding quality in percent, e.g. **73%**

```
Version
SW: xxxxx HW: xxx
```

- 1st line: **version** display function
- 2nd line: software and hardware version of the device

9 Leuze webConfig tool

With the **Leuze webConfig tool**, an operating system independent, web-technology based, graphical user interface is available for configuring bar code readers of the **BCL 300i** series. Through the use of HTTP as communication protocol and by using only standard technologies on the client side (HTML, JavaScript and AJAX), which are supported by all commonly used, modern browsers (e.g. **Mozilla Firefox** beginning with Version 3.0 or **Internet Explorer** beginning with Version 8.0), it is possible to operate the **Leuze webConfig tool** on any internet-ready PC.



Notice!

The webConfig tool is offered in 6 languages:

- German
- English
- French
- Italian
- Spanish
- Chinese

9.1 Connecting the SERVICE USB interface

The SERVICE USB interface of the BCL 358*i* is connected via the PC -side USB interface by means of a standard USB cable, with 1 type A connector and 1 Mini-B type connector.

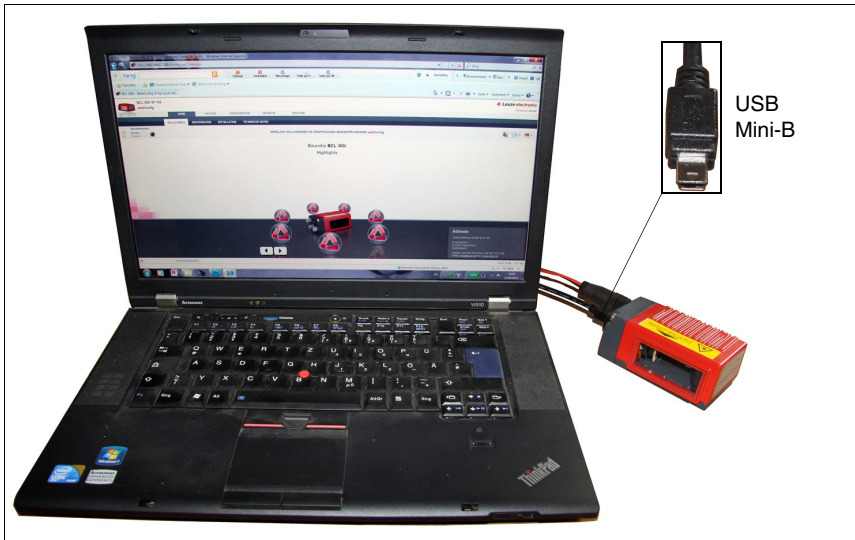

Figure 9.1: Connecting the SERVICE USB interface

9.2 Installing the required software

9.2.1 System requirements

Operating system:	Windows 2000 Windows XP (Home Edition, Professional) Windows Vista Windows 7
Computer:	PC with USB interface version 1.1 or higher
Graphics card:	min. 1024 x 768 pixels or higher resolution
Required hard-disk capacity:	approx. 10MB

**Notice!**

Updating the operating system and the browser regularly and installing the current Windows service packs is recommended.

9.2.2 Installing the USB driver

**Notice!**

*If you have already installed a USB driver for a BCL 5xx*i* on your computer, you don't have to install the USB driver for the BCL 358*i*. In this case, you can also start the webConfig tool of the BCL 358*i* by double-clicking on the BCL 5xx*i* icon.*

In order for the BCL 358*i* to be automatically detected by the connected PC, the **USB driver** must be installed **once** on your PC. To do this, you must have **administrator privileges**.

Please proceed according to the following steps:

- ↳ Start your PC with administrator privileges and log on.
- ↳ Load the CD included in the delivery contents of your BCL 358*i* in the CD drive and start the "setup.exe" program.
- ↳ Alternatively, you can also download the setup program from the internet at www.leuze.com.
- ↳ Follow the instructions provided by the setup program.

Upon successful installation of the USB driver, an  icon with the name **Leuze Web Config** automatically appears on the desktop.

**Notice!**

If the installation failed, contact your network administrator: The settings of the firewall used may need to be adjusted.

9.3 Starting the webConfig tool

To start the **webConfig tool**, click the  icon with the name **Leuze Web Config** located on the desktop. Make certain that the BCL 358*i* is connected to the PC via the USB interface and that voltage is connected. Alternatively, the **webConfig tool** can also be directly started via the Ethernet connection.



Notice!

*If you have already installed a USB driver for a BCL 5xx*i* on your computer, you can also start the webConfig tool of the BCL 358*i* by double-clicking on the BCL 5xx*i* icon.*

Alternatively, you can start the webConfig tool by starting the browser installed on your PC and entering the following IP address: **192.168.61.100**.

This is the default Leuze maintenance address for communication with bar code readers of the BCL 300*i* and BCL 500*i* series.

In both cases, the following start page appears on your PC.

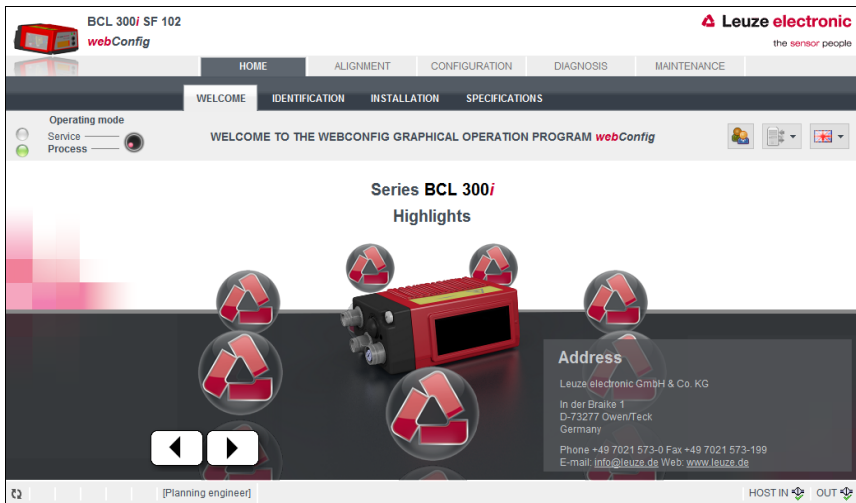

Figure 9.2: The start page of the webConfig tool



Notice!

*The webConfig tool is completely contained in the firmware of the BCL 358*i*. Depending on firmware version, the start page may vary from that shown above.*

The individual parameters are – where useful – graphically displayed in order to better illustrate the meaning of the what are often perceived as abstract parameters.

The result is an easy-to-use and practically-oriented user interface!

9.4 Short description of the webConfig tool

The webConfig tool has 5 main menus:

- **Home**
with information on the connected BCL 358*i* as well as on installation. This information corresponds to the information in this handbook.
- **Alignment**
for manually starting read processes and for aligning the bar code reader. The results of the read processes are displayed immediately. As a result, this menu item can be used to determine the optimum installation location.
- **Configuration**
for adjusting decoding, for data formatting and output, switching inputs/outputs, communication parameters and interfaces, etc. ...
- **Diagnostics**
for event logging of warnings and errors.
- **Maintenance**
for updating the firmware.

The user interface of the webConfig tool is largely self-explanatory.

9.4.1 Module overview in the Configuration menu

The adjustable parameters of the BCL 358*i* are clustered in modules in the Configuration menu.

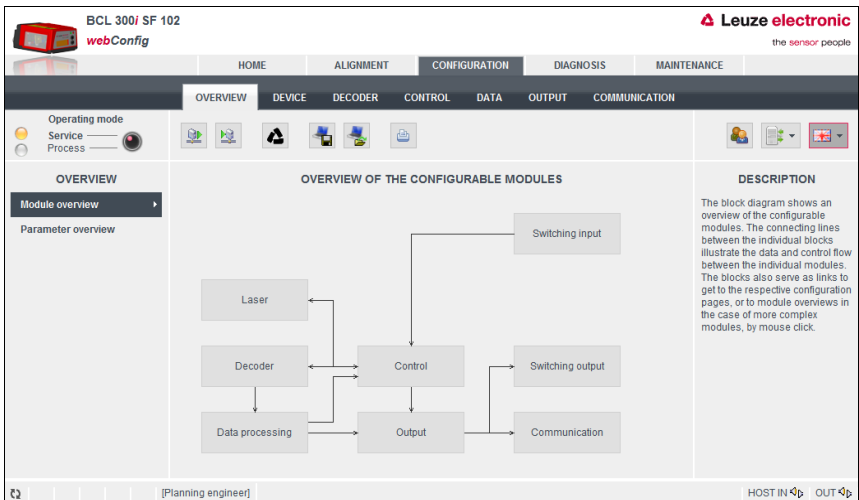

Figure 9.3: Module overview in the webConfig tool

**Notice!**

The webConfig tool is completely contained in the firmware of the BCL 358*i*. Depending on firmware version, the module overview may vary from that shown above.

The individual modules and their relationships to one another are graphically displayed in the module overview. The display is context sensitive, i.e. click a module to directly access the corresponding submenu.

Overview of the configurable modules

- **Device:**
Configuration of the **switching inputs and outputs**
- **Decoder**
Configuration of the decoder table, such as **code type, number of digits**, etc.
- **Control:**
Configuration of **activation** and **deactivation**, e.g. **auto-activation, AutoReflAct**, etc.
- **Data**
Configuration of **code content**, such as **filtering, segmentation of bar code data**, etc.
- **Output**
Configuration of **data output, header, trailer, reference code**, etc.
- **Communication**
Configuration of the **host interface** and the **service interface**, e.g. **IP address**, etc.
- **Oscillating mirror:**
Configuration of the **oscillating mirror settings**

**Notice!**

On the right side of the user interface of the webConfig tool, you will find a description of the individual modules and functions as a help text in the **Information** area.

10 Commissioning and configuration

**Attention Laser!**

Observe the safety notices in chapter 2!

This chapter describes basic configuration steps which you can carry out via the webConfig tool or the Rockwell control.

Via the webConfig tool

The most convenient way to configure the BCL 358*i* is via the webConfig tool. To use the webConfig tool, you need to establish a USB connection between the BCL 358*i* and a PC/laptop.

**Notice!**

Notes on the use of the webConfig tool can be found in chapter 9 "Leuze webConfig tool" on page 88.

10.1 Measures to be performed prior to the initial commissioning

- ↳ Before commissioning, familiarize yourself with the operation and configuration of the BCL 358*i*.
- ↳ Before connecting the supply voltage, recheck all connections and ensure that they have been properly made.

The description of the electrical connections can be found in chapter 7.

10.2 Starting the device

↳ Connect the +18 ... 30VDC supply voltage (typ. +24VDC); the BCL 358*i* starts up and the bar code reading window appears on the display.



Notice!

The BCL 358*i* can decode the following code types in the standard setting:

- **Code 128** Number of digits 4 ... 63
- **2/5 Interleaved** Number of digits 10
- **Code 39** Number of digits 4 ... 30
- **EAN 8 / 13** Number of digits 8 and 13
- **UPC** Number of digits 8
- **Codabar** Number of digits 4 ... 63
- **Code 93** Number of digits 4 ... 63
- **Code GS1 Data Bar OMNIDIRECTIONAL**
- **Code GS1 Data Bar LIMITED**
- **Code GS1 Data Bar EXPANDED**

Deviations from these settings must be set via the webConfig tool. See "Leuze webConfig tool" on page 88.

As a first step, you need to set the communication parameters of the BCL 358*i*.

10.3 Setting the communication parameters

With the communication parameters, you determine how data is exchanged between BCL 358*i* and the host system. The communication parameters are independent of the topology in which the BCL 358*i* is operated. See "Ethernet topologies" on page 80.

On delivery, the automatic address assignment via DHCP server is defined as the standard setting of the BCL 358*i*.

10.3.1 Manually setting the IP address

There are two ways to set the IP address manually. Either via **BootP/DHCP server tool** or via the **webConfig tool** using the USB connection. For this purpose, the DHCP operation in the BCL 358*i* must be deactivated.

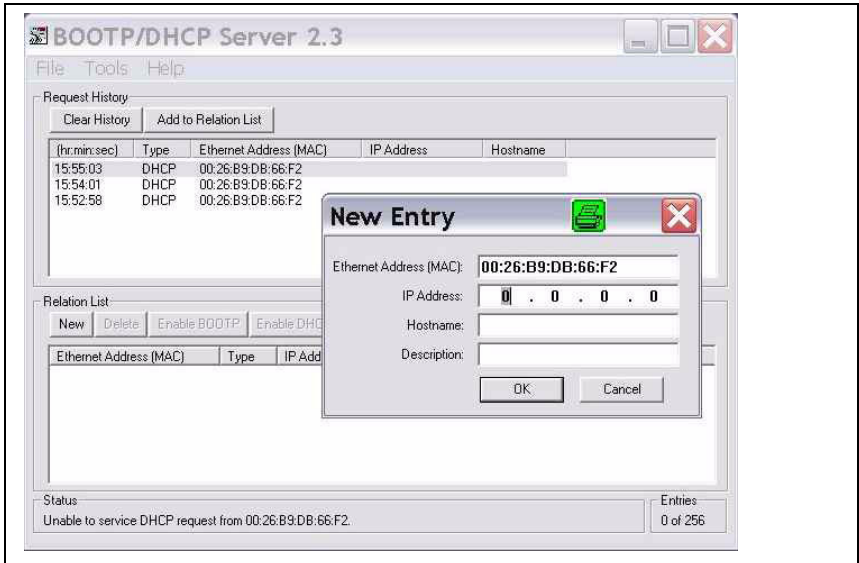

Figure 10.1: Manually setting the IP address

If no DHCP server is present in your system, you must permanently set the IP address of the BCL 358*i*. Proceed as follows:

- Have the network administrator specify the data for IP address, net mask and gateway address of the BCL 358*i*.
- Connect the BCL 358*i* to your computer using the service cable.
- Set these values on the BCL 358*i*:

Via webConfig tool

- In the main menu, select Configuration, submenu Communication -> Ethernet interface.
- Deactivate the DHCP operation and enter the IP address.



Notice!

If the IP address is set via the webConfig tool, then it becomes active after transfer to the device. A restart is not required.

10.4 Configuration steps for a Rockwell control without EDS support

10.4.1 Integrating the hardware into the PLC using the generic Ethernet module

In configuration tool **RSLogix 5000 up to software version 20.00**, a so-called **generic Ethernet module** is created under the Communication path for the BCL 358*i*.

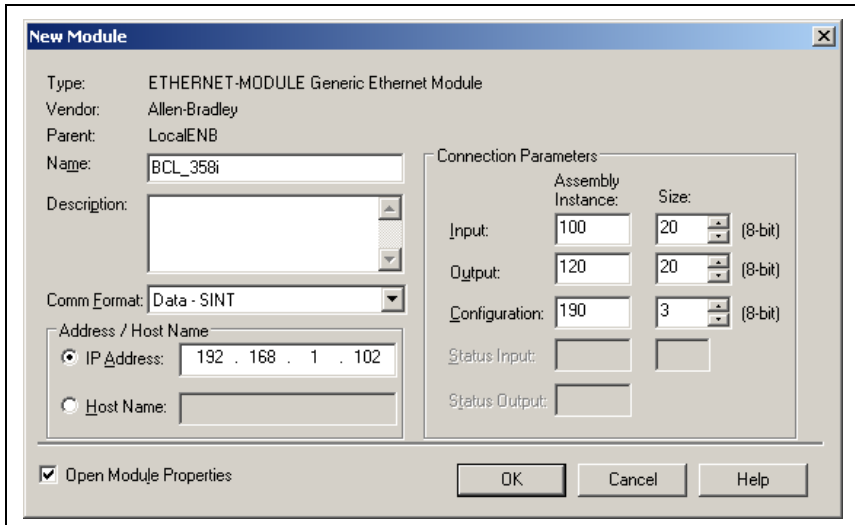

Figure 10.2: Generic Ethernet module

The input mask for the generic module describes the following parameters to be set:

- The name of the participant (can be selected freely; e.g. BCL 358*i*).
- The format of I/O data (data - SINT = 8 bits)
- The IP address of the participant
- The address and length of the input assembly (instance 100, instance 101 or instance 102; min 1 byte - up to max. 266 bytes for the default input assembly of the read results).
- The address and length of the output assembly (instance 120, instance 121 or instance 122; min 1 byte - up to max. 263 bytes for the default output assembly)
- The address and length of the configuration assembly (instance 190; 3 bytes)

10.5 Configuration steps for a Rockwell control with EDS support

The following steps are necessary for commissioning with a Rockwell control:

- Creation of the EtherNet/IP participants in PLC software **RSLogix 5000 from Version 20.00 and up** (with EDS support).
- Installation of the EDS file using the EDS wizard.
- Setting the parameters of the BCL 358*i* via the configuration assembly or webConfig.

10.5.1 Integrating the hardware into the PLC and installing the EDS file

To integrate the device and to establish a connection between the PLC and the device BCL 358*i*, proceed as follows:

- First, load the EDS file for the device **via EDS wizard** into the PLC database.



Notice!

You can find the EDS file at: www.leuze.com.

- After it has downloaded, select the device from the device list.
- Open the input dialog for setting the address and additional parameters by double-clicking on the device symbol and make the desired entries here. Under **Change**, define the combination of input and output assemblies.

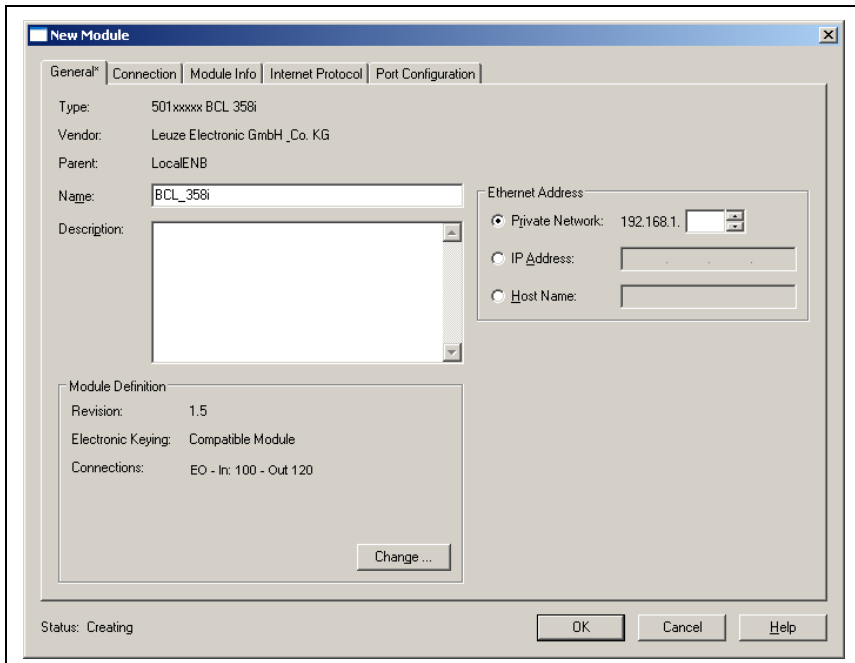

Figure 10.3: New module

- Finally, transmit the values to the control via download.

10.6 EDS file - general info

The EDS file contains all identification and communication parameters of the device, as well as the available objects. PLC software **RSLogix 5000** from Rockwell offers **EDS support for EtherNet/IP from software version 20.00 and up**.

The BCL 358*i* is uniquely classified via a class 1 identity object (component of the **BCL358i.eds** file) for the EtherNet/IP scanner. The identity object contains, among other things, a manufacturer-specific vendor ID, as well as an ID that describes the principle function of the participant.

If accepting the objects without change, all parameters are set to default values. The default settings are shown in the objects described in detail in the **Default** column.



Notice!

In the following tables, all attributes marked in the Access column with Get in the individual objects are to be understood as inputs of the control. Attributes marked in the Access column with Set represent outputs or parameters.

10.7 Detailed EDS description

10.7.1 Class 1 - Identity object

Object class 1 = 0x01

Services:

- Get attribute single 0x0E
- Reset type 0x05

Cl.	Path		Designation	Size in bit	Data type	Default (dec)	Min (dec)	Max (dec)	Access
	Inst.	Attr.							
1	1	1	Vendor-Id	16	UINT	524	-	-	Get
		2	Device type	16	UINT	43	-	-	Get
		3	Product Code	16	UINT	5	-	-	Get
		4	Revision (Major, minor)	16	Struct{ USINT major, USINT minor};	Major = 1, Minor = 1	Major = 1, Minor = 1	Major = 127, Minor = 999	Get
		5	Status	16	WORD	See CIP specification (5-2.2.1.5 status)			Get
		6	Serial number	32	UDINT	Manufacturer specific			Get
		7	Product name	(max. 32) x 8	SHORT_STRING	"BCL 358i"			Get

In the network configuration (e.g., **RSLogix 5000, generic module**), it is possible to specify when entering the individual participants which attributes of the scanner are to be monitored from the identity object.

Vendor ID

The vendor ID assigned by **ODVA** for **Leuze electronic GmbH + Co. KG** is 524_D.

Device type

The BCL 358*i* is defined as a **generic device (keyable)** by Leuze electronic. According to **ODVA**, the BCL 358*i* is assigned number 43_D = 0x2B.

Product Code

The **product code** is an ID assigned by Leuze electronic that has no further impact on other objects.

Revision

Version number of the identity object.

Status

The device status is displayed in the status byte, the first part of the telegram.

Bit 7	Bit 6	Bit 5	Bit 4	Bit 3	Bit 2	Bit 1	Bit 0
ext. device state				reserved	configured	reserved	owned
Bit 15	Bit 14	Bit 13	Bit 12	Bit 11	Bit 10	Bit 9	Bit 8
reserved							

Serial number

For use in EtherNet/IP, the serial number receives a serial number converted according to CIP. CIP describes a special format for the serial number. After conversion to a CIP code, the serial number is, as before, unique, but no longer corresponds in its resolution to the serial number on the name plate.

Product name

This attribute contains a short designation of the product. Devices with the same product code may have different **product names**.

10.7.2 Class 4 - Assembly

The following assemblies are supported by the profile. A distinction is made between input and output assembly. The input assembly groups the data from the BCL 358*i* for the control. The data from the control are transmitted to the BCL 358*i* via the output assembly.

10.7.2.1 Input assembly

The input assembly is the cyclical data from the BCL 358*i* to the control. The following three input assemblies are supported.

Input assembly instance 100

Instance 100, attribute 3

Input assembly, length min. 1 byte
max. 260 bytes

Inst.	Byte	Bit 7	Bit 6	Bit 5	Bit 4	Bit 3	Bit 2	Bit 1	Bit 0
100	0	Device status							
	1	Number of results							
	2	Reserved		Waiting for acknowledgement	New result (toggle bit)	Buffer overflow	Further results in the buffer	User data or command	Status activation
	3	Result data length (low byte)							
	4	Result data length (high byte)							
	5	Data byte 0							
	6	Data byte 1							
							
	259	Data byte 254							

The number of data starting at byte 5 is defined in the control while configuring the BCL 358*i*. This makes it possible to use the assembly with any length.



Notice!

The use of the assembly is illustrated with examples at the end of this chapter.



Notice!

Formula for calculating the assembly length:

Length of the assembly = 5 + length of the result/bar code

For results/bar codes with length 10, the assembly must be configured with a length of 5 + 10 = 15.

Input assembly instance 101

Instance 101, attribute 3

Input assembly, length min. 1 byte
 max. 264 bytes

Inst.	Byte	Bit 7	Bit 6	Bit 5	Bit 4	Bit 3	Bit 2	Bit 1	Bit 0
101	0	Device status							
	1	Reserved	Error code			Reserved		Data rejection (toggle bit)	Data acceptance (toggle bit)
	2	Fragment number (see chapter 10.7.5 "Class 107 - Result data")							
	3	Remaining fragments (see chapter 10.7.5 "Class 107 - Result data")							
	4	Fragment size (see chapter 10.7.5 "Class 107 - Result data")							
	5	Number of results							
	6	Reserved	Waiting for acknowledgement	New result (toggle bit)	Buffer overflow	Further results in the buffer	User data or command	Status activation	
	7	Result data length (low byte)							
	8	Result data length (high byte)							
	9	Data byte 0							
	10	Data byte 1							
							
	263	Data byte 254							

The number of data starting at byte 9 is defined in the control while configuring the BCL 358*i*. This makes it possible to use the assembly with any length.



Notice!

The use of the assembly is illustrated with examples at the end of this chapter.



Notice!

Formula for calculating the assembly length:

Length of the assembly = 9 + length of the result/bar code.

For results/bar codes with length 10, the assembly must be configured with a length of 9 + 10 = 19.

Input assembly instance 102

Instance 102, attribute 3

Input assembly, length min. 1 byte
max. 265 bytes

Inst.	Byte	Bit 7	Bit 6	Bit 5	Bit 4	Bit 3	Bit 2	Bit 1	Bit 0	
102	0	Device status								
	1	Reserved	Switching output comparison state 2 (toggle bit)	Switching output comparison state 2	Status input/output I/O 2	Reserved	Switching output comparison state 1 (toggle bit)	Switching output comparison state 1	Status input/output I/O 1	
	2	Reserved	Error code			Reserved		Data rejection (toggle bit)	Data acceptance (toggle bit)	
	3	Fragment number (see chapter 10.7.5 "Class 107 - Result data")								
	4	Remaining fragments (see chapter 10.7.5 "Class 107 - Result data")								
	5	Fragment size (see chapter 10.7.5 "Class 107 - Result data")								
	6	Number of results								
	7	Reserved	Waiting for acknowledgement	New result (toggle bit)	Buffer overflow	Further results in the buffer	User data or command	Status activation		
	8	Result data length (low byte)								
	9	Result data length (high byte)								
	10	Data byte 0								
	11	Data byte 1								
								
	264	Data byte 254								

The number of data starting at byte 10 is defined in the control while configuring the BCL 358*i*. This makes it possible to use the assembly with any length.



Notice!

The use of the assembly is illustrated with examples at the end of this chapter.



Notice!

Formula for calculating the assembly length:

Length of the assembly = 10 + length of the result/bar code.

For results/bar codes with length 10, the assembly must be configured with a length of 10 + 10 = 20.

10.7.2.2 Output assembly

The output assembly is the cyclical data from the control to the BCL 358*i*. The following output assemblies are supported.

Output assembly instance 120

Instance 120, attribute 3

Output assembly, length min. 1 byte
max. 263 bytes

Inst.	Byte	Bit 7	Bit 6	Bit 5	Bit 4	Bit 3	Bit 2	Bit 1	Bit 0	
120	0	Reserved			Standby	Error acknowledge	Data reset	Data acknowledgement	Activation signal	
	1	Reserved					Reset event counter 2	Activation switching output 2 ¹⁾	Reset event counter 1	Activation switching output 1 ¹⁾
	2	Fragment number (see chapter 10.7.6 "Class 108 - Entry data")								
	3	Remaining fragments (see chapter 10.7.6 "Class 108 - Entry data")								
	4	Fragment size (see chapter 10.7.6 "Class 108 - Entry data")								
	5	Reserved							New entry (toggle bit)	New data
	6	Entry data length (low byte)								
	7	Entry data length (high byte)								
	8	Data byte 0								
	9	Data byte 1								
								
	262	Data byte 254								

1) To be able to use the **Activation switching output** function, the output function must be set to **External event** in webConfig.

The number of data starting at byte 8 is defined in the control while configuring the BCL 358*i*. This makes it possible to use the assembly with any length.

It is also possible to specify the length of the assembly with one byte and thereby only use the control bits. With a length of 2 bytes, the I/O monitoring control bits can be used in addition to the control bits.



Notice!

The use of the assembly is illustrated with examples at the end of this chapter.



Notice!

Formula for calculating the assembly length:

Length of the assembly = 8 + length of the entry data.

For entry data with length 10, the assembly must be configured with a length of 8 + 10 = 18.

Output assembly instance 121

Instance 121, attribute 3

Output assembly, length min. 1 byte
max. 262 bytes

Inst.	Byte	Bit 7	Bit 6	Bit 5	Bit 4	Bit 3	Bit 2	Bit 1	Bit 0	
121	0	Reserved			Standby	Error acknowledge	Data reset	Data acknowledgement	Activation signal	
	1	Fragment number (see chapter 10.7.6 "Class 108 - Entry data")								
	2	Remaining fragments (see chapter 10.7.6 "Class 108 - Entry data")								
	3	Fragment size (see chapter 10.7.6 "Class 108 - Entry data")								
	4	Reserved						New entry (toggle bit)	New data	
	5	Entry data length (low byte)								
	6	Entry data length (high byte)								
	7	Data byte 0								
	8	Data byte 1								
								
	261	Data byte 254								

The number of data starting at byte 7 is defined in the control while configuring the BCL 358*i*. This makes it possible to use the assembly with any length.

It is also possible to specify the length of the assembly with one byte and thereby only use the control bits.



Notice!

The use of the assembly is illustrated with examples at the end of this chapter.



Notice!

Formula for calculating the assembly length:

Length of the assembly = 7 + length of the entry data.

For entry data with length 10, the assembly must be configured with a length of 7 + 10 = 17.

Output assembly instance 122

Instance 122, attribute 3

Output assembly, length min. 1 byte
max. 261 bytes

Inst.	Byte	Bit 7	Bit 6	Bit 5	Bit 4	Bit 3	Bit 2	Bit 1	Bit 0	
122	0	Fragment number (see chapter 10.7.6 "Class 108 - Entry data")								
	1	Remaining fragments (see chapter 10.7.6 "Class 108 - Entry data")								
	2	Fragment size (see chapter 10.7.6 "Class 108 - Entry data")								
	3	Reserved							New entry (toggle bit)	New data
	4	Entry data length (low byte)								
	5	Entry data length (high byte)								
	6	Data byte 0								
	7	Data byte 1								
								
	260	Data byte 254								

The number of data starting at byte 6 is defined in the control while configuring the BCL 358*i*. This makes it possible to use the assembly with any length.



Notice!

The use of the assembly is illustrated with examples at the end of this chapter.



Notice!

Formula for calculating the assembly length:

Length of the assembly = 6 + length of the entry data.

For entry data with length 10, the assembly must be configured with a length of 6 + 10 = 16.

10.7.2.3 Configuration assembly

The configuration assembly is the data from the control to the BCL 358*i* which is transferred as the configuration during the establishment of communication. The following configuration assembly is supported.

Configuration assembly instance 190

Instance 190, attribute 3

Configuration assembly, length 3 bytes

Inst.	Byte	Bit 7	Bit 6	Bit 5	Bit 4	Bit 3	Bit 2	Bit 1	Bit 0
190	0	Reserved							Mode 0 = without ACK 1 = with ACK
	1	Reserved							Activate result fragmentation 0 = fragmentation inactive 1 = fragmentation active
	2	Reserved							Activate entry fragmentation 0 = fragmentation inactive 1 = fragmentation active

Byte	Cross reference address	Bit assignment (default)								Default
		7	6	5	4	3	2	1	0	
0	106 / 1 / 1	-	-	-	-	-	-	-	0	0x00
1	107 / 1 / 9	-	-	-	-	-	-	-	0	0x00
2	108 / 1 / 8	-	-	-	-	-	-	-	0	0x00



Notice!

In the configuration assembly, all parameters have the value 0. Changing the individual default values is possible at any time. The participant is thereby defined in offline mode; the data must subsequently be transferred to the control.

10.7.3 Class 103 - I/O status and control

This class is for handling switching input and switching output signals.

Object class 103 = 0x67

Services:

- Get attribute single 0x0E
- Set attribute single 0x10

Path			Designation	Size in bit	Data type	Default (dec)	Min (dec)	Max (dec)	Access
Cl.	Inst.	Attr.							
103	1	1-4	Reserved						
	SWIO_1	5	Status (input/output)	8	U8	0	0	1	Get
		6	Output activation	8	U8	0	0	1	Set
		7	Reset Event Counter	8	U8	0	0	1	Set
		8	Switching output comparative state (event counter)	8	U8	0	0	1	Get
		9	Switching output comparative state toggle bit (event counter)	8	U8	0	0	1	Get
103	2	1-4	Reserved						
	SWIO_2	5	Status (input/output)	8	U8	0	0	1	Get
		6	Output activation	8	U8	0	0	1	Set
		7	Reset Event Counter	8	U8	0	0	1	Set
		8	Switching output comparative state (event counter)	8	U8	0	0	1	Get
		9	Switching output comparative state toggle bit (event counter)	8	U8	0	0	1	Get



Notice!

Toggle bits are control and monitoring control flags which are not level-sensitive, but rather triggered by edges.

Attributes 1-4

Attributes 1-4 are not supported in this profile.

Status (input/output)

Signal state of switching input or output.

Output activation

Sets the state of the switching output

- 0 Switching output 0 - low - inactive
- 1 Switching output 1 - high - active

Reset Event Counter

Resets the event counter of the activation function back to zero

- 0 → 1 perform reset
- 1 → 0 no function

Switching output comparative state (event counter)

Indicates whether the event counter has exceeded the set comparative value.

The bit is reset to the init. value by resetting the event counter.

- 0** not exceeded
- 1** exceeded

Switching output comparative state toggle bit (event counter)

If **SWOUT switches several times** was configured as comparison mode, this bit is toggled each time the event counter is exceeded. The bit is reset to the init. value by resetting the event counter.

- 0 → 1** event counter exceeded
- 1 → 0** event counter exceeded again

10.7.4 Class 106 - Activation

This class defines the control signals for activating the BCL 358*i* as well as the signals for the control of the result output. It is possible to select between standard data output operation and handshake operation.

In handshake operation, the controller must acknowledge the data reception via the ACK bit before the new data is written into the input area. After acknowledging the last result, the input data is reset (filled with zeros).

Object class 106 = 0x6A

Services:

- Get attribute single 0x0E
- Set attribute single 0x10

Cl.	Path		Designation	Size in bit	Data type	Default (dec)	Min (dec)	Max (dec)	Access
	Inst.	Attr.							
106	1	1	Mode ¹⁾	8	U8	0	0	1	Set
		2	Number of results	8	U8	0	0	255	Get
		3	Activation signal	8	U8	0	0	1	Set
		4	Data acknowledgement	8	U8	0	0	1	Set
		5	Data reset	8	U8	0	0	1	Set

- 1) This attribute is a parameter. The value of the parameter can be set via the configuration assembly.

Mode

The parameter defines the mode in which the communication is operated.

- 0 without ACK
- 1 with ACK

Number of results

This value specifies how many messages are ready to be picked up in the BCL 358*i*.

Activation signal

Signal for activating the BCL 358*i*. This action opens or closes the reading gate of the BCL 358*i*. This attribute is edge-triggered, not level-controlled.

- 0 → 1 activation (open reading gate)
- 1 → 0 deactivation (close reading gate)

Data acknowledgement

This control bit signals that the transmitted data have been processed by the master. Only relevant with handshake mode (with ACK), see **Mode**.

- 0 → 1 data has been processed by the master
- 1 → 0 data has been processed by the master

Data reset

Deletes results that may have been stored and resets the input data.

0 → 1 data reset

If the data reset control bit is activated, the following actions are carried out:

1. Deletion of results that may still be stored.
2. Resetting of the attributes of **Class 107 - Result data**

10.7.5 Class 107 - Result data



Notice!

The result is the data from the BCL 358*i* to the control.

This class defines the transfer of result data. The result data comes from the Formatter currently selected. This can be selected and configured in WebConfig. This class also defines the output of fragmented results. To occupy few I/O data, the results may be split into several fragments with this class. The fragments can then be transmitted one after another with a handshake.

Object class 107 = 0x6B

Services:

- Get attribute single 0x0E
- Set attribute single 0x10

Cl.	Path		Designation	Size in bit	Data type	Default (dec)	Min (dec)	Max (dec)	Access
	Inst.	Attr.							
107	1	1	Activation status	8	U8	0	0	1	Get
		2	User data or command	8	U8	0	0	1	Get
		3	Further results in the buffer	8	U8	0	0	1	Get
		4	Buffer overflow	8	U8	0	0	1	Get
		5	New result (toggle bit)	8	U8	0	0	1	Get
		6	Waiting for acknowledgement	8	U8	0	0	1	Get
		7	Result data length	16	U16	0	0	65.535	Get
		8	Data	2048	U8 [256]	0	0	255	Get
		9	Activate result fragmentation ¹⁾	8	U8	0	0	1	Set
		10	Fragment number	8	U8	0	0	255	Get
		11	Remaining fragments	8	U8	0	0	255	Get
		12	Fragment size	8	U8	32	0	255	Get

1) This attribute is a parameter. The value of the parameter can be set via the configuration assembly.

Activation status

Displays the current activation status.

- 0 deactivated
- 1 activated

User data or command

Distinction between result from the Formatter and answer from the command interpreter. Makes the distinction easy for the user.

- 0 user data
- 1 answer from the command interpreter

Further results in the buffer

This signal indicates whether further results are in the buffer.

- 0 no
- 1 yes

Buffer overflow

This signal indicates that all result buffers are occupied and that BCL 358*i* rejects data.

- 0 no
- 1 yes

New result (toggle bit)

The toggle bit indicates whether a new result is present.

- 0 → 1 new result
- 1 → 0 new result

Waiting for acknowledgement

This signal represents the internal state of the control.

- 0 base state
- 1 control waiting for acknowledgement from the master

Result data length

Data length of the actual result information. If the result information fits the selected assembly length, this value reflects the length of the transferred data. A value larger than the assembly length indicates a loss of information caused by an assembly length which has been selected to be too small.

Data

Result information with a length of maximum 256 bytes.

Activate result fragmentation

This attribute specifies whether the messages from the BCL 358*i* to the control should be transferred in fragments.

- 0 fragmentation inactive
- 1 fragmentation active

Fragment number

Current fragment number

Remaining fragments

Number of fragments which still have to be read for a complete result.

Fragment size

Fragment size always corresponds to the configured fragment length, except for the last fragment.

10.7.6 Class 108 - Entry data



Notice!

The entry is the data from the control to the BCL 358*i*.

This class defines the transfer of entry data to a command interpreter in the BCL 358*i*. This class also defines the transfer of fragmented entry data.

To occupy few I/O data, the entry data may be split into several fragments with this class. The fragments can then be transmitted one after another with a handshake.

Object class 108 = 0x6C

Services:

- Get attribute single 0x0E
- Set attribute single 0x10

Cl.	Path		Designation	Size in bit	Data type	Default (dec)	Min (dec)	Max (dec)	Access
	Inst.	Attr.							
108	1	1	Data acceptance (toggle bit)	8	U8	0	0	1	Get
		2	Data rejection (toggle bit)	8	U8	0	0	1	Get
		3	Error code	8	U8	0	0	8	Get
		5	New entry (toggle bit)	8	U8	0	0	1	Set
		6	Entry data length	16	U16	0	0	65.535	Set
		7	Data	2048	U8 [256]	0	0	255	Set
		8	Activate entry fragmentation ¹⁾	8	U8	0	0	1	Set
		9	Fragment number	8	U8	0	0	255	Set
		10	Remaining fragments	8	U8	0	0	255	Set
		11	Fragment size	8	U8	0	0	255	Set

- 1) This attribute is a parameter. The value of the parameter can be set via the configuration assembly.

Data acceptance (toggle bit)

The signal shows that the BCL 358*i* has accepted the data or the data fragment (also see **Data rejection** toggle bit).

- 0 → 1 data have been accepted
- 1 → 0 data have been accepted

Data rejection (toggle bit)

The BCL 358*i* has rejected the acceptance of the data or the data fragment (also see **Data acceptance** toggle bit).

- 0 → 1 data have been rejected
- 1 → 0 data have been rejected

Error code

Cause of error if a message is rejected.

- 0 no error
- 1 receive buffer overflow
- 2 sequence error, i.e. an error was detected with the fragment number transferred from the control, the number of remaining fragments or the fragment size.



Notice!

The following sequence diagram shows with examples how the **Data acceptance**, **Data rejection** and **Error code** attributes are connected.

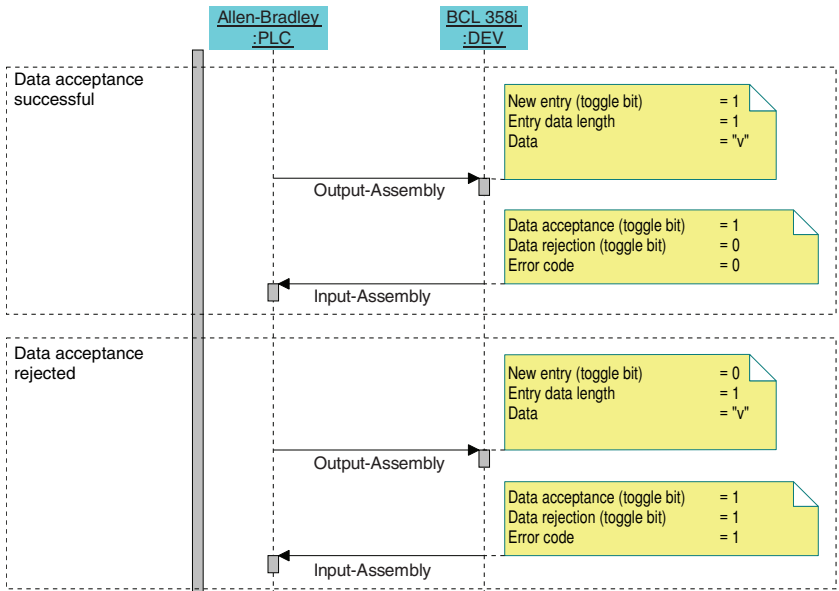

Figure 10.4: Connection between Data acceptance/Data rejection/Error code attributes

New entry (toggle bit)

The toggle bit shows whether new entry data are present.

- 0 → 1 new result
- 1 → 0 new result

Entry data length

Data length of the actual information.

Data

Information with a length of maximum 256 bytes.

Activate entry fragmentation

This attribute specifies whether the messages from the control to the BCL 358*i* should be transferred in fragments.

- 0 fragmentation inactive
- 1 fragmentation active

Fragment number

Current fragment number

Remaining fragments

Number of fragments which still have to be transmitted for a complete entry.

Fragment size

The fragment size should always be identical, except for the last fragment to be transferred. A fragment size of 0 means that the fragmentation is not used.

10.7.7 Class 109 - Device status and device control

This class contains the display of the device status as well as control bits for deleting an error or putting the BCL 358*i* into standby mode.

Object class 109 = 0x6D

Services:

- Get attribute single 0x0E
- Set attribute single 0x10

Cl.	Path		Designation	Size in bit	Data type	Default (dec)	Min (dec)	Max (dec)	Access
	Inst.	Attr.							
109	1	1	Device status	8	U8	15	0	129	Get
		2	Error acknowledge	8	U8	0	0	1	Set
		3	Standby	8	U8	0	0	1	Set

Device status

This byte represents the device status:

- 10** standby
- 15** device is ready
- 128** error
- 129** warning

Error acknowledge

This control bit confirms and deletes errors or warnings that may be present in the system. It acts like a toggle bit.

- 0 → 1** error acknowledge
- 1 → 0** error acknowledge

StandBy

Activates the standby function.

- 0** standby off
- 1** standby on

10.8 Configuration example

In the following sections, various examples show how the profile previously described can be used to solve different scenarios.

The following scenarios are illustrated with examples:

- **Example 1** - activation & result
In: 33 bytes
Out: 1 byte
Config: 0 bytes
- **Example 2** - activation & result & I/Os
In: 20 bytes
Out: 2 bytes
Config: 0 bytes
- **Example 3** - activation & fragmented result
In: 13 bytes
Out: 1 byte
Config: 3 bytes
- **Example 4** - entry data & result
In: 33 bytes
Out: 10 bytes
Config: 0 bytes

10.8.1 Example 1 - activation & result

The following screenshot shows the configuration of the device in the **RSLogix 5000** control software.

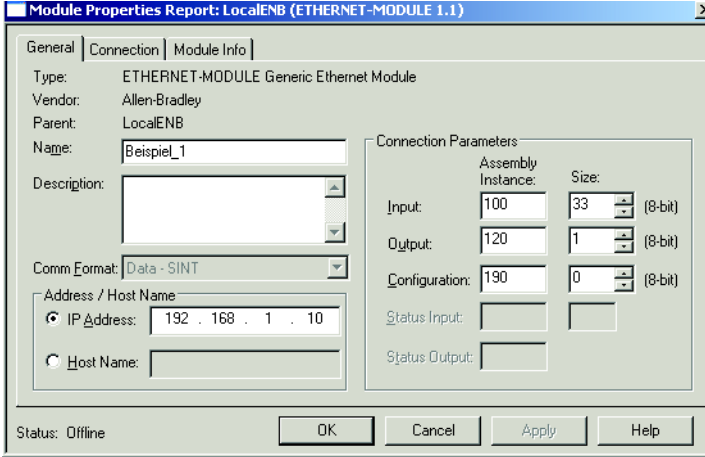

Figure 10.5: Configuration of example 1 - module definition with generic module

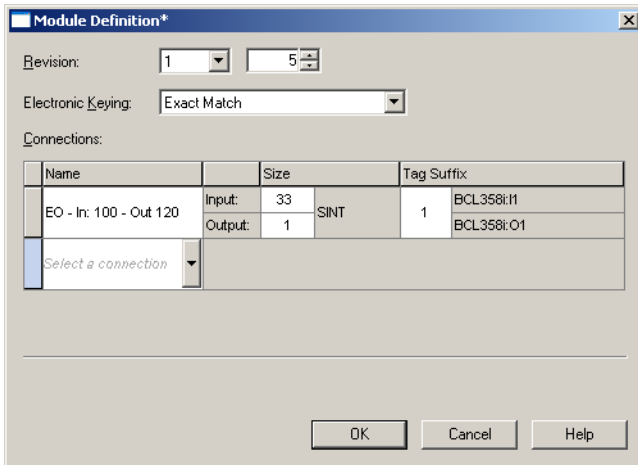

Figure 10.6: Configuration of example 1 - module definition with the EDS file

Structure of input assembly 100

Inst.	Byte	Bit 7	Bit 6	Bit 5	Bit 4	Bit 3	Bit 2	Bit 1	Bit 0
100	0	Device status							
	1	Number of results							
	2	Reserved		Waiting for acknowledgement	New result (toggle bit)	Buffer overflow	Further results in the buffer	User data or command	Status activation
	3	Result data length (low byte)							
	4	Result data length (high byte)							
	5	Data byte 0							
	6	Data byte 1							
							
	32	Data byte 27							

Structure of output assembly 120

Inst.	Byte	Bit 7	Bit 6	Bit 5	Bit 4	Bit 3	Bit 2	Bit 1	Bit 0
120	0	Reserved			Standby	Error acknowledge	Data reset	Data acknowledgement	Activation signal

Structure of configuration assembly 190

Since the configuration is not used, the length of the configuration assembly is specified as 0. The device then operates with the default values. In this case, the acknowledge mode is not used.

Below, examples of what data exchange looks like during two subsequent activations are shown.

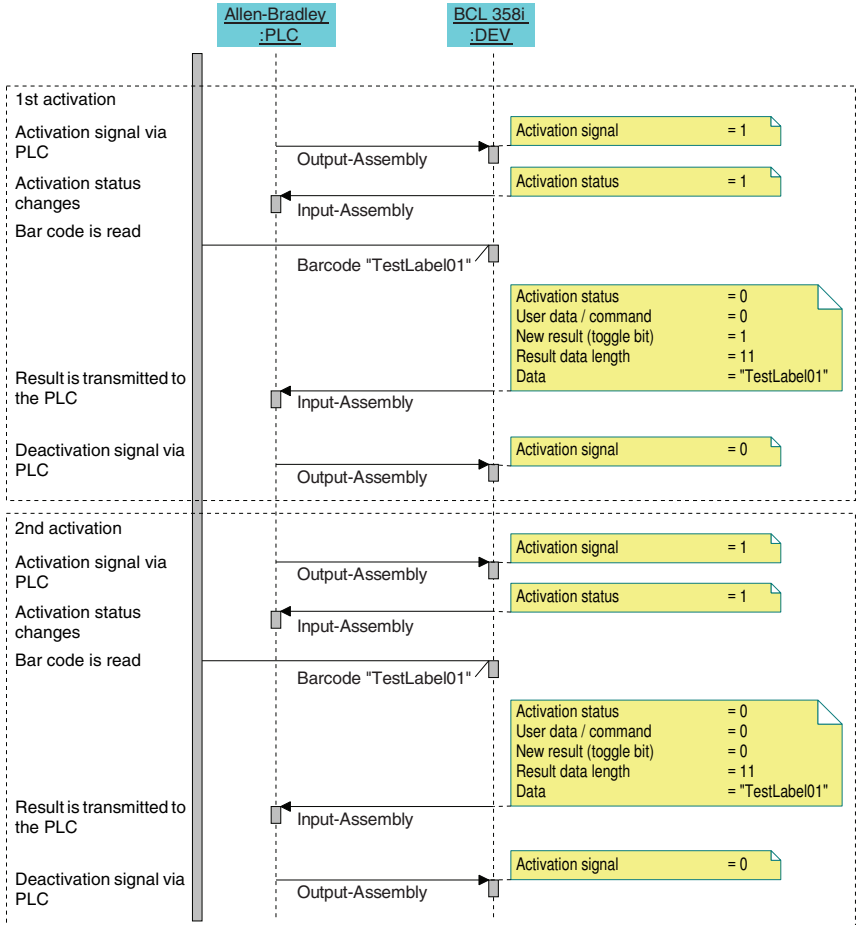

Figure 10.7: Data exchange sequence diagram - example 1

10.8.2 Example 2 - activation & result & I/Os

The following screenshot shows the configuration of the device in the **RSLogix 5000** control software.

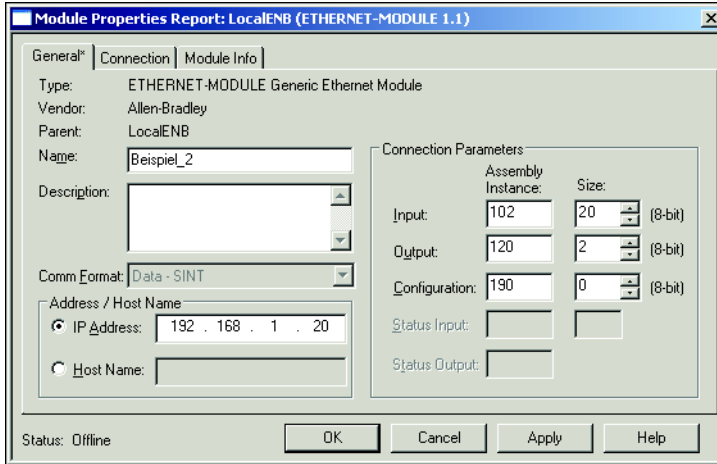

Figure 10.8: Configuration of example 2 - module definition with generic module

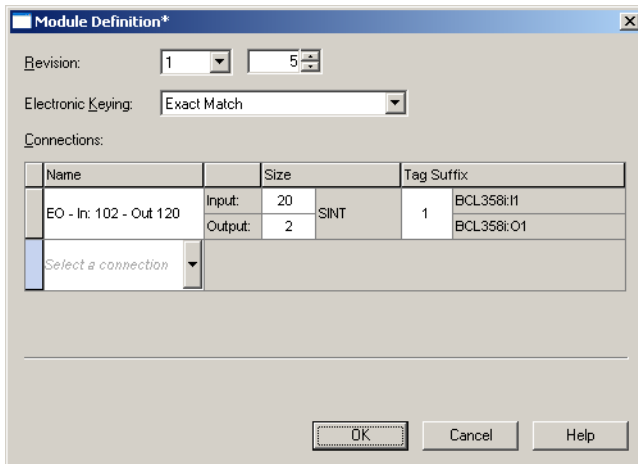

Figure 10.9: Configuration of example 2 - module definition with the EDS file

Structure of input assembly 102

Inst.	Byte	Bit 7	Bit 6	Bit 5	Bit 4	Bit 3	Bit 2	Bit 1	Bit 0
102	0	Device status							
	1	Reserved	Switching output comparison state 2 (toggle bit)	Switching output comparison state 2	Status input/output I/O 2	Reserved	Switching output comparison state 1 (toggle bit)	Switching output comparison state 1	Status input/output I/O 1
	2	Reserved	Error code			Reserved		Data rejection (toggle bit)	Data acceptance (toggle bit)
	3	Fragment number (see chapter 10.7.5 "Class 107 - Result data")							
	4	Remaining fragments (see chapter 10.7.5 "Class 107 - Result data")							
	5	Fragment size (see chapter 10.7.5 "Class 107 - Result data")							
	6	Number of results							
	7	Reserved		Waiting for acknowledgement	New result (toggle bit)	Buffer overflow	Further results in the buffer	User data or command	Status activation
	8	Result data length (low byte)							
	9	Result data length (high byte)							
	10	Data byte 0							
	11	Data byte 1							
							
	19	Data byte 9							

Structure of output assembly 120

Inst.	Byte	Bit 7	Bit 6	Bit 5	Bit 4	Bit 3	Bit 2	Bit 1	Bit 0
120	0	Reserved			Standby	Error acknowledge	Data reset	Data acknowledgement	Activation signal
	1	Reserved				Reset event counter 2	Activation switching output 2 1)	Reset event counter 1	Activation switching output 1 1)

1) To be able to use the **Activation switching output** function, the output function must be set to **External event** in webConfig.

Structure of configuration assembly 190

Since the configuration is not used, the length of the configuration assembly is specified as 0. The device then operates with the default values. In this case, the acknowledge mode is not used.

Below, examples of what data exchange looks like during two subsequent activations are shown. Switching output 1 reflects the activation signal. Switching output 2 displays whether the result is valid (status input/output I/O 2 = 1] or whether a NoRead has taken place (status input/output I/O 2 = 0).

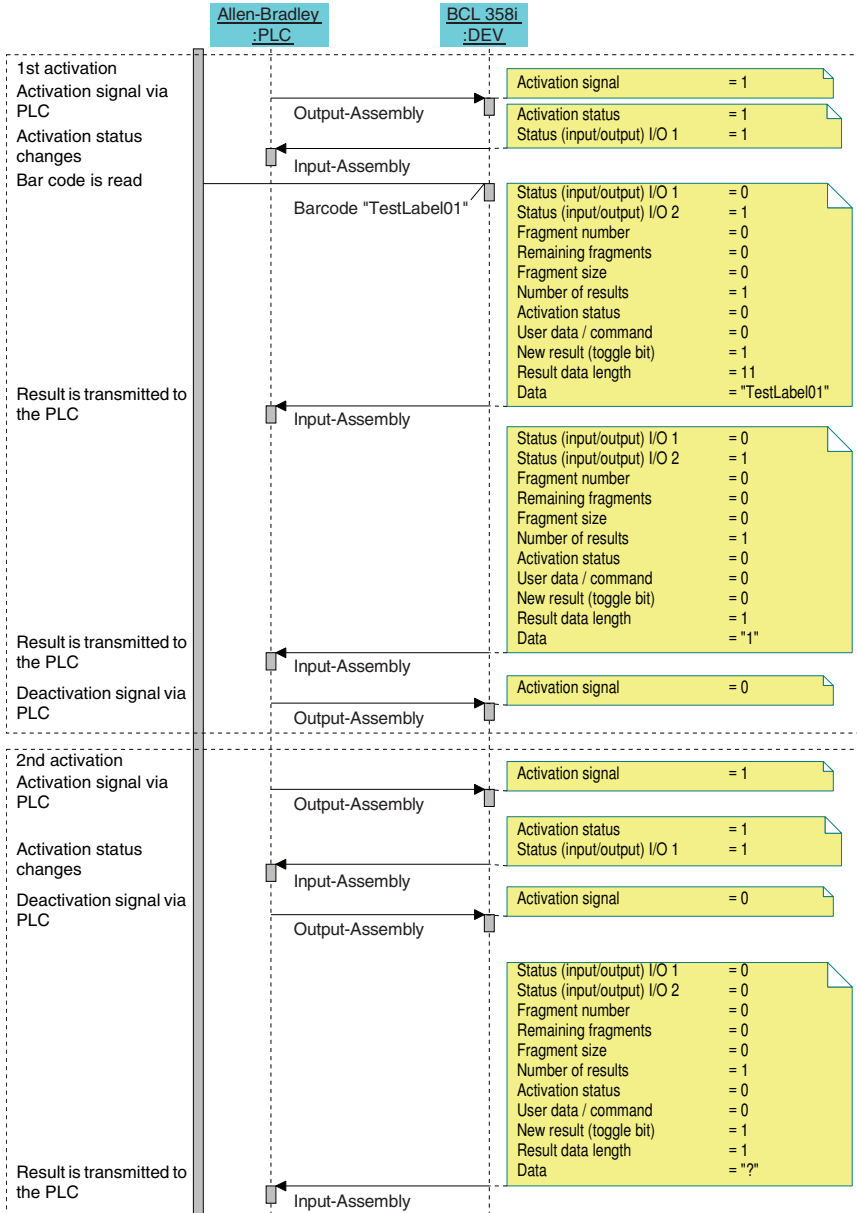

Figure 10.10: Data exchange sequence diagram - example 2

10.8.3 Example 3 - activation & fragmented result

The following screenshot shows the configuration of the device in the **RSLogix 5000** control software.

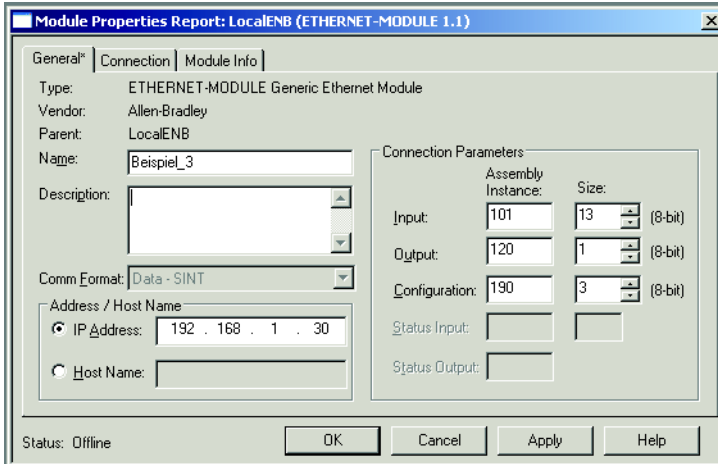

Figure 10.11: Configuration of example 3 - module definition with generic module

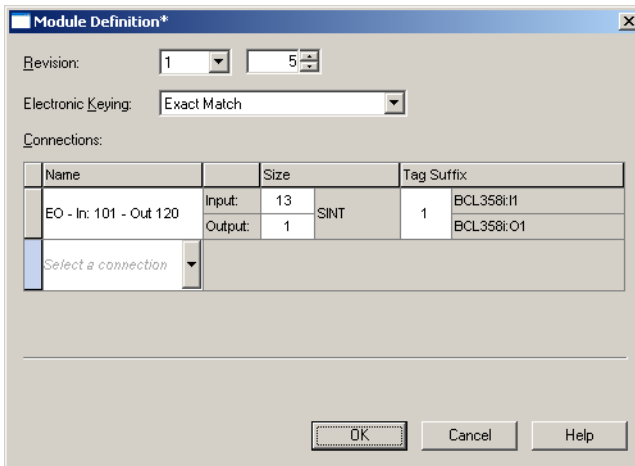

Figure 10.12: Configuration of example 3 - module definition with the EDS file

Structure of input assembly 101

Inst.	Byte	Bit 7	Bit 6	Bit 5	Bit 4	Bit 3	Bit 2	Bit 1	Bit 0
101	0	Device status							
	1	Reserved	Error code			Reserved		Data rejection (toggle bit)	Data acceptance (toggle bit)
	2	Fragment number (see chapter 10.7.5 "Class 107 - Result data")							
	3	Remaining fragments (see chapter 10.7.5 "Class 107 - Result data")							
	4	Fragment size (see chapter 10.7.5 "Class 107 - Result data")							
	5	Number of results							
	6	Reserved		Waiting for acknowledgement	New result (toggle bit)	Buffer overflow	Further results in the buffer	User data or command	Status activation
	7	Result data length (low byte)							
	8	Result data length (high byte)							
	9	Data byte 0							
	10	Data byte 1							
	11	Data byte 2							
	12	Data byte 3							

Structure of output assembly 120

Inst.	Byte	Bit 7	Bit 6	Bit 5	Bit 4	Bit 3	Bit 2	Bit 1	Bit 0
120	0	Reserved			Standby	Error acknowledge	Data reset	Data acknowledgement	Activation signal

Structure of configuration assembly 190

Byte	Cross reference address	Bit assignment (default)								Default
		7	6	5	4	3	2	1	0	
0	106 / 1 / 1	-	-	-	-	-	-	-	1	0x00
1	107 / 1 / 9	-	-	-	-	-	-	-	1	0x00
2	108 / 1 / 8	-	-	-	-	-	-	-	0	0x00

Below, examples of what data exchange looks like when the result is transferred in fragments are shown.

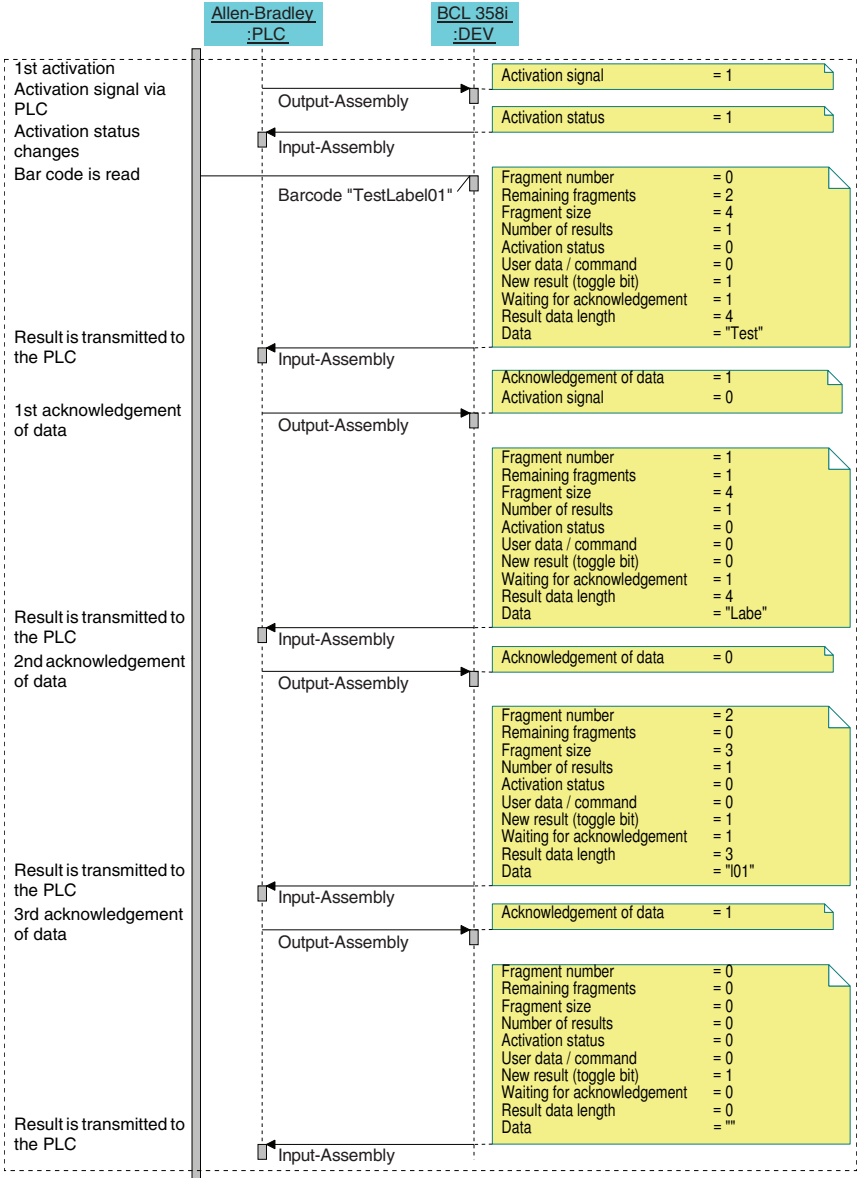

Figure 10.13: Data exchange sequence diagram - example 3

10.8.4 Example 4 - entry data & result

The following screenshot shows the configuration of the device in the **RSLogix 5000** control software.

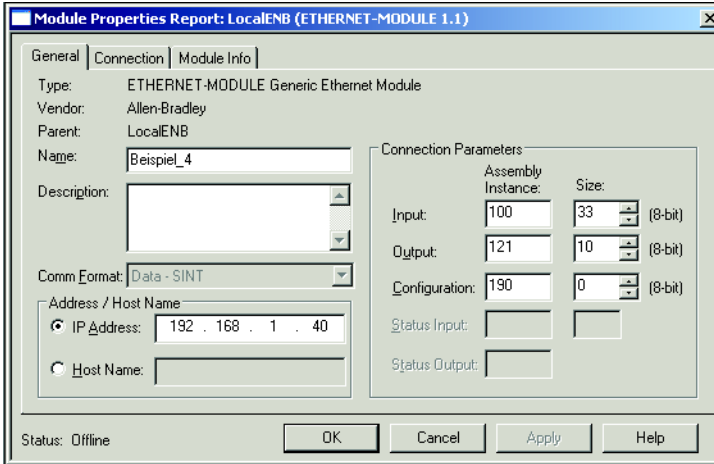

Figure 10.14: Configuration of example 4 - module definition with generic module

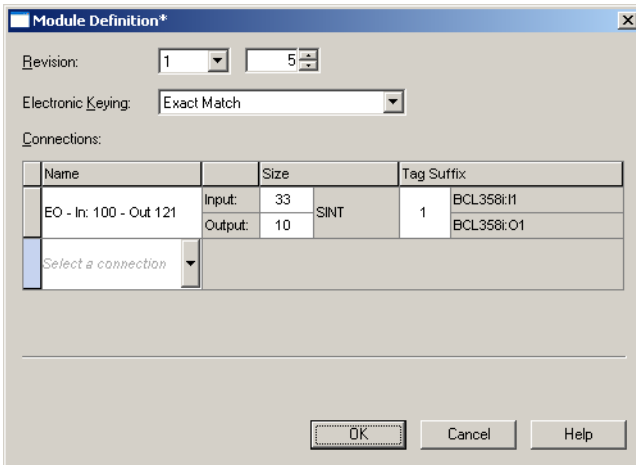

Figure 10.15: Configuration of example 4 - module definition with the EDS file

Structure of input assembly 100

Inst.	Byte	Bit 7	Bit 6	Bit 5	Bit 4	Bit 3	Bit 2	Bit 1	Bit 0
100	0	Device status							
	1	Number of results							
	2	Reserved		Waiting for acknowledgement	New result (toggle bit)	Buffer overflow	Further results in the buffer	User data or command	Status activation
	3	Result data length (low byte)							
	4	Result data length (high byte)							
	5	Data byte 0							
	6	Data byte 1							
							
	32	Data byte 27							

Structure of output assembly 121

Inst.	Byte	Bit 7	Bit 6	Bit 5	Bit 4	Bit 3	Bit 2	Bit 1	Bit 0
121	0	Reserved			Standby	Error acknowledgement	Data reset	Data acknowledgement	Activation signal
	1	Fragment number (see chapter 10.7.6 "Class 108 - Entry data")							
	2	Remaining fragments (see chapter 10.7.6 "Class 108 - Entry data")							
	3	Fragment size (see chapter 10.7.6 "Class 108 - Entry data")							
	4	Reserved						New entry (toggle bit)	New data
	5	Entry data length (low byte)							
	6	Entry data length (high byte)							
	7	Data byte 0							
	8	Data byte 1							
	9	Data byte 2							

Structure of configuration assembly 190

Since the configuration is not used, the length of the configuration assembly is specified as 0. The device then operates with the default values. In this case, the acknowledge mode is not used.

Below, examples of what data exchange looks like when the entry function is used are shown.

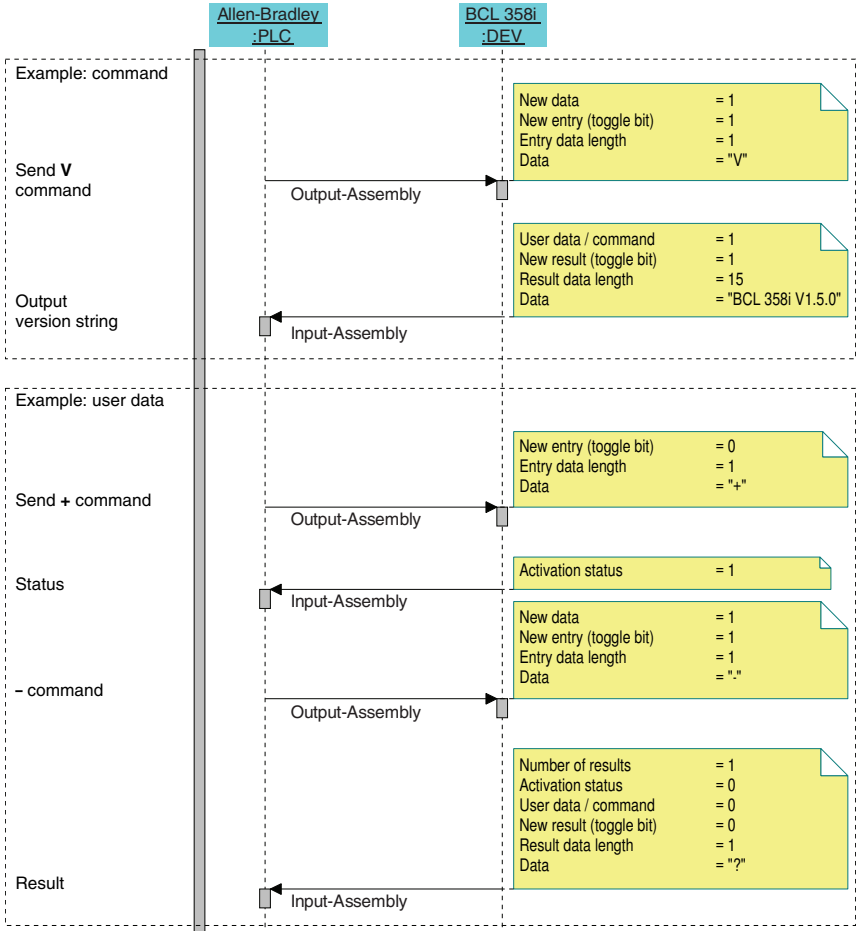

Figure 10.16: Data exchange sequence diagram - example 4

10.9 Additional settings for the BCL 358*i*

After the basic configuration of the operating mode and the communication parameters, you need to carry out further settings via the webConfig tool:

- Decoding and processing the read data
- Control of the decoding
- Control of the switching outputs

10.9.1 Decoding and processing the read data

The BCL 358*i* offers the following options:

- Setting the number of labels to be decoded for each reading gate (0 ... 64). This is done via the `Max. no. of labels` parameter.
- Definition of up to 8 different code types. Labels that match one of the defined code types are decoded. Further parameters can be set for each code type:
 - The `code type (symbology)`
 - The `Number of digits`: either up to 5 different numbers of digits (e.g., 10, 12, 16, 20, 24), or a range (`Interval mode`) and up to three additional numbers of digits (e.g., 2 ... 10, 12, 16, 26)
 - The `Reading reliability`: the set value specifies how many times a label must be read and decoded with the same result before the result is accepted as valid.
 - Additional code type specific settings (in the webConfig tool only)
 - `Check digit method` used for decoding as well as the type of `Check digit output` for the read result. The two possibilities for the latter are `Standard` (corresponds to the standard for the selected code type/symbology) and `not Standard`.

↳ *Define at least one code type with the desired settings.*

- Via webConfig:
Configuration -> Decoder

Data processing via the webConfig tool

In the `Data` and `Output` submenus of the `Configuration` main menu, the webConfig tool provides extensive data processing options to adapt the functionality of the BCL 358*i* to the specific reading task:

- Data filtering and segmentation in the `Data` submenu:
 - Data filtering according to characteristics for handling identical bar code information.
 - Data segmentation for differentiating between identifier and content of the read data.
 - Data filtering according to content and/or identifier in order to suppress the output of bar codes with specific content/identifiers.
 - Completeness inspection of the read data.
- Sorting and formatting the output data in the `Output` submenu:
 - Configuration of up to 3 different sorting criteria. Sorting by physical data and content of the read bar codes.
 - Formatting of the data output for the HOST.
 - Formatting of the data output for the display.

10.9.2 Control of the decoding

In general, decoding is controlled via one or more of the configurable switching inputs/outputs. For this purpose, the respective connection to the SW IN/OUT and POWER interfaces must be configured as a switching input.

Via a switching input, you can:

- start decoding
 - stop decoding
 - start decoding and then stop decoding after a configurable time period
 - read a reference code
 - start the automatic code type configuration (AutoConfig)
- ↳ Connect the required control devices (photoelectric sensor, proximity switch, etc.) as described in chapter 7 to the BCL 358*i*.
- ↳ Configure the connected switching inputs according to your requirements. To do this, first set the I/O mode to Input and then configure the switching behavior:
- Via webConfig:
Configuration -> Device -> Switching inputs/outputs



Notice!

Alternatively, one can also activate decoding via the online command '+' and deactivate it via the online command '-'. Further information on the online commands can be found in chapter 11.

Advanced decoder control via the webConfig tool

The webConfig tool provides advanced functions, in particular for deactivating decoding. These may be accessed via the Control submenu of the Configuration main menu. You can:

- activate decoding automatically (delayed)
- stop decoding after a maximum reading gate time
- stop decoding via the completeness mode, if:
 - the maximum number of bar codes to be decoded has been decoded
 - a positive reference code comparison has taken place.

10.9.3 Control of the switching outputs

By using the switching inputs/outputs of the BCL 358*i*, external event-controlled functions can be implemented without assistance from the superior process control. For this purpose, the respective connection at the SW IN/OUT and POWER interfaces must be configured as a switching output.

A switching output can be activated:

- at the start/end of the reading gate
- depending on the read result:
 - reference code comparison positive/negative
 - read result valid/invalid
- depending on the state of the device:
 - ready/not ready
 - data transmission active/not active
 - active/standby
 - error/no error
- etc.

↳ *As described in chapter 7 of the manual, connect the required switching outputs.*

↳ *Configure the connected switching outputs according to your requirements. To do this, first set the I/O mode to Output and then configure the switching behavior:*

- Via webConfig:
Configuration -> Device -> Switching inputs/outputs

10.10 Transmitting configuration data

Instead of going through the tedious task of configuring every parameter of the BCL 358*i* individually, you can also conveniently transfer configuration data.

Configuration data can be transferred between two bar code readers BCL 358*i* as follows:

- Storage in a file and transfer using the webConfig tool

10.10.1 Via the webConfig tool

With the webConfig tool, you can store entire configurations of the BCL 358*i* on data carriers and transfer them from these to the BCL 358*i*.

This storage of configuration data is especially useful if you want to store basic configurations which will require only minor changes.

In the webConfig tool, you store the configuration data via the buttons in the upper part of the middle window of all submenus of the Configuration main menu.

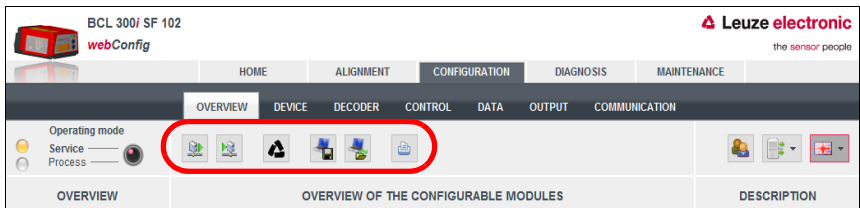

Figure 10.17: Storing configuration data in the webConfig tool

10.10.2 Replacing a defective BCL 358*i*

The MS 358 connector hood and the MK 358 terminal hood feature an integrated parameter memory in which the configuration data is saved as a backup. If a defective BCL 358*i* has to be replaced, proceed as follows:

- ↳ *Disconnect the defective BCL 358*i* from the voltage supply.*
- ↳ *Dismount the defective BCL 358*i* and disconnect it from the hoods with integrated connectors/terminal hoods.*
- ↳ *Connect the new BCL 358*i* to the connection hood and remount the unit.*
- ↳ *Recommission the new BCL 358*i* (reconnect the voltage supply).
The configuration is now imported from the external parameter memory of the connection hood and the BCL 358*i* is immediately operational without any further configuration.*

11 Online commands

11.1 Overview of commands and parameters

Online commands can be used to send commands directly to the device for control and configuration.

For this purpose, the BCL 358*i* must be connected to a host- or service computer via the interface. The commands described can be sent either via the host or the service interface.

Online commands

With the commands, you can:

- control/decode.
- read/write/copy parameters.
- carry out an automatic configuration.
- teach-in/set reference codes.
- call up error messages.
- call up statistical device information.
- carry out a software reset in order to reinitialize the device.

Syntax

"Online" commands consist of one or two ASCII characters followed by command parameters.

No separation characters may be entered between the command and the command parameter(s). Both small and capitalized letters can be used.

Example:

Command '**CA**': autoConfig function

Parameter '**+**': activation

Transmitted is: '**CA+**'

Notation

Commands, command parameters and returned data are enclosed between single quotation marks ' ' in the text of this manual.

Most online commands are acknowledged by the BCL 358*i* and any requested data returned. For commands that are not acknowledged, command execution can be observed or monitored directly on the device.

11.1.1 General 'online' commands

Software version number

Command	'V'
Description	Requests device version information
Parameter	No
Acknowledgment	'BCL 358i SM 100 V 1.5.0 2012-07-15' The first line contains the device type of the BCL 358 <i>i</i> , followed by the device version number and version date. (The data which is actually displayed may vary from the values given here.)



Notice!

This command returns the major release number of the software packet. This major release number also appears on the display during start-up. This command can be used to check whether the connected host or service computer is properly connected and configured. If you do not receive an acknowledgment, please check interface connections, protocol and service switches.

Software reset

Command	'H'
Description	Carries out a software reset. The device is restarted and reinitialized, leaving it in the same state as when the supply voltage is switched on.
Parameter	No
Acknowledgment	'S' (start signal)

Code recognition

Command	'CC'
Description	Detects an unknown bar code and outputs number of digits, code type, and code information to the interface, without storing the bar code in the parameter memory.
Parameter	No
Acknowledg- ment	<p>'xx yy zzzzzz'</p> <p>xx: Code type of the read code</p> <p>'01' 2/5 Interleaved</p> <p>'02' Code 39</p> <p>'03' Code 32</p> <p>'06' UPC (A, E)</p> <p>'07' EAN</p> <p>'08' Code 128, EAN 128</p> <p>'10' EAN Addendum</p> <p>'11' Codabar</p> <p>'12' Code 93</p> <p>'13' GS1 DataBar OMNIDIRECTIONAL</p> <p>'14' GS1 DataBar LIMITED</p> <p>'15' GS1 DataBar EXPANDED</p> <p>yy: Number of digits of the read code</p> <p>zzzzzz: Contents of the decoded label. A ↑ appears if the label was not correctly read.</p>

autoConfig

Command	'CA'
Description	Activates or deactivates the 'autoConfig' function. BCL 358 <i>i</i> . Certain label reading parameters are programmed automatically in the setup by the labels which the BCL 358 <i>i</i> reads while the 'autoConfig' function is active.
Parameter	'+' Activates 'autoConfig' '/' Rejects the last code read '-' Deactivates 'autoConfig' and stores the decoded data in the current parameter set.
Acknowledgment	'CSx' x Status '0' Valid 'CA' command '1' Invalid command '2' autoConfig could not be activated '3' autoConfig could not be deactivated '4' Result could not be deleted
Description	'xx yy zzzzzz' xx No. of digits of the read code yy Code type of the read code '01' 2/5 Interleaved '02' Code 39 '03' Code 32 '06' UPC (A, E) '07' EAN '08' Code 128, EAN 128 '10' EAN Addendum '11' Codabar '12' Code 93 '13' GS1 DataBar OMNIDIRECTIONAL '14' GS1 DataBar LIMITED '15' GS1 DataBar EXPANDED zzzzzz: Contents of the decoded label. A ↑ appears if the label was not correctly read.

Alignment mode

Command	'JP'
Description	<p>This command simplifies mounting and alignment of the BCL 358<i>i</i>. After activating the function with 'JP+', the BCL 358<i>i</i> continuously supplies status information to the serial interfaces.</p> <p>With this online command, the scanner is set to terminate the decoding after 100 successfully decoded labels and output the status information. Subsequently, the read process is reactivated automatically.</p> <p>In addition to the output of the status information, the laser beam is used to display the reading quality. Depending on how many read results could be extracted, the duration of the laser's "off" time increases.</p> <p>If the reading quality is high, the laser beam flashes in brief, regular intervals. The worse the decoder decodes, the longer the pauses become during which the laser is switched off. The flashing intervals become more and more irregular because the laser may, in total, be active for longer to extract more labels. The duration of the pauses has been stepped in such a way that they can be distinguished by the eye.</p>
Parameter	<p>'+' : Starts the adjustment mode. '-' : Ends the adjustment mode.</p>
Acknowledgment	<p>'yyy_zzzzzz'</p> <p>yyy: Reading quality in %. A high process availability is ensured at read qualities > 75%.</p> <p>zzzzz: Bar code information.</p>

Manual definition of the reference code

Command	'RS'
Description	This command can be used to define a new reference code in the BCL 358 <i>i</i> by means of direct input via the serial interface. The data is saved in the parameter set according to your input under reference code 1 through 2 and stored in the working buffer for direct further processing.
Parameter	<p>'RSyvxxzzzzzzz'</p> <p>y, v, x and z are placeholders (variables) for the actual input.</p> <p>y Defined reference code no. '1' (Code 1) '2' (Code 2)</p> <p>v Storage location for reference code: '0' RAM+EEPROM, '3' RAM only</p> <p>xx Defined code type (see command 'CA')</p> <p>z Defined code information (1 ... 63 characters)</p>
Acknowledgment	<p>'RSx'</p> <p>x Status '0' Valid 'Rx' command '1' Invalid command '2' Insufficient memory for reference code '3' Reference code has not been saved '4' Reference code invalid</p>
Example	Input = 'RS130678654331' (Code 1 (1), RAM only (3), UPC (06), code information)

Reference code teach-in

Command	'RT'
Description	This command enables a reference code to be defined quickly by reading an example label.
Parameter	<p>'RTy' y Function</p> <p>'1' Defines reference code 1</p> <p>'2' Defines reference code 2</p> <p>'+' Activates the definition of reference code 1 up to the value of Parameter no_of_labels</p> <p>'-' Exits the Teach-in process</p>
Acknowledgment	<p>The BCL 358<i>i</i> first responds with the command 'RS' and corresponding status (see command 'RS'). After a bar code has been read, it sends the result in the following format:</p> <p>'RCyvxxzzzz'</p> <p>y, v, x and z are placeholders (variables) for the actual input.</p> <p>y Defined reference code no.</p> <p>'1' (Code 1)</p> <p>'2' (Code 2)</p> <p>v Memory location for reference code</p> <p>'0' RAM+EEPROM,</p> <p>'3' RAM only</p> <p>xx Defined code type (see command 'CA')</p> <p>z Defined code information (1 ... 63 characters)</p>



Notice!

With this function, only code types are recognized that are identified using the autoConfig function or which were set in the setup.

After each reading via an 'RTy' command, explicitly switch off the function again since failure to do so will interfere with other commands as well as prevent execution of a new 'RTx' command.

Reading a reference code

Command	'RR'
Description	The command reads out the reference code defined in the BCL 358 <i>i</i> . If no parameters are specified, all defined codes are output.
Parameter	<Reference code number> '1' ... '2' value range of reference codes 1 to 2
Acknowledgment	If no reference codes are defined, the BCL 358 <i>i</i> responds with the 'RS' command and corresponding status (see command 'RS'). For valid codes, the output corresponds to the following format: RCyvxzzzzzz y, v, x and z are placeholders (variables) for the actual input. y Defined reference code no. '1' (Code 1) '2' (Code 2) v Memory location for reference code '0' RAM+EEPROM, '3' RAM only xx Defined code type (see command 'CA') z Defined code information (1 ... 63 characters)

11.1.2 'Online' commands for system control

Activating sensor input

Command	'+'
Description	<p>The command activates decoding. This command is used to activate the reading gate. It remains active until it is deactivated by one of the following criteria:</p> <ul style="list-style-type: none"> • Deactivation by a manual command • Deactivation by a switching input • Deactivation upon reaching the specified read quality (equal scans) • Deactivation by timeout • Deactivation upon reaching a preset number of scans without information.
Parameter	No
Acknowledgment	None

Deactivating sensor input

Command	'-'
Description	<p>The command deactivates decoding. This command can be used to deactivate the reading gate. Following deactivation, the read result is output. Because the reading gate was manually deactivated and, thus, no GoodRead criterion was met, a NoRead is output.</p>
Parameter	No
Acknowledgment	None

11.1.3 'Online' commands for configuration of switching inputs/outputs

Activate switching output

Command	'OA'
Description	The switching outputs 1 and 2 can be activated with this command. The respective port must have been configured as a switching output. The logic state is output, i.e., an inverted logic is taken into account (e.g., inverted logic and a state of High corresponds to a voltage of 0V at the switching output).
Parameter	'OA<a>' <a> Selected switching output [1, 2], unit (dimensionless)
Acknowledgment	None

Query the state of the switching outputs

Command	'OA'
Description	This command may be used to query the states of the switching inputs and outputs that are configured as a switching output and that have been set via commands. The logic state is output, i.e., an inverted logic is taken into account (e.g., inverted logic and a state of High corresponds to a voltage of 0V at the switching output).
Parameter	'OA?'
Acknowledgment	'OA S1=<a>;S2=<a>' <a> State of the switching outputs '0' Low '1' High 'I' Configuration as switching input 'P' Passive configuration

Set the state of the switching outputs

Command	'OA'
Description	This command is used to set the states of the switching inputs/outputs that are configured as a switching output. The logic state is specified, i.e., an inverted logic is taken into account (e.g., inverted logic and a state of High corresponds to a voltage of 0V at the switching output). The values of the switching inputs/outputs that are not configured as switching outputs are ignored. You may also use only a selection of the existing switching inputs/outputs as long as these are listed in ascending order.
Parameter	'OA [S1=<a>];S2=<a>] <a> State of the switching output '0' Low '1' High
Acknowledgment	'OA=<aa> <aa> Status acknowledgment, unit (dimensionless) '00' Ok '01' Syntax error '02' Parameter error '03' Other error

Deactivate switching output

Command	'OD'
Description	The switching outputs 1 and 2 can be deactivated with this command. The respective port must have been configured as a switching output. The logic state is output, i.e., an inverted logic is taken into account (e.g., inverted logic and a state of High corresponds to a voltage of 0V at the switching output).
Parameter	'OD<a> <a> Selected switching output [1, 2], unit (dimensionless)
Acknowledgment	None

Query the configuration of the switching inputs/outputs

Command	'OF'
Description	This command may be used to query the configuration of the switching inputs/outputs 1 and 2.
Parameter	'OF?'
Acknowledgment	'OF S1=<a>;S2=<a>' <a> Function of the switching input/ output, unit [dimensionless]' 'I' Switching input 'O' Switching output 'P' Passive

Configure the switching inputs/ outputs

Command	'OF'
Description	This command may be used to configure the function of the switching inputs/outputs 1 and 2. You may also use only a selection of the existing switching inputs/outputs as long as these are listed in ascending order.
Parameter	'OF [S1=<a>];[S2=<a>]' <a> Function of the switching input/ output, unit [dimensionless]' 'I' Switching input 'O' Switching output 'P' Passive
Acknowledgment	'OF=<bb>' <bb> Status acknowledgment '00' Ok '01' Syntax error '02' Parameter error '03' Other error

11.1.4 'Online' commands for the parameter set operations

Copying parameter set

Command	'PC'
Description	This command can only be used to copy parameter sets in their entirety. This can be used to replicate the three parameter sets default , permanent and operating parameters on the basis of one another. In addition, this command can also be used to restore the factory settings.
Parameter	<p>'PC<Source type><Target type>'</p> <p><Source type> Parameter data set which is to be copied, unit [dimensionless]</p> <p>'0' Parameter data set in permanent memory</p> <p>'2' Default or factory parameter set</p> <p>'3' Operating parameter data set in volatile memory</p> <p><Target type> Parameter set to which the data is to be copied, unit [dimensionless]</p> <p>'0' Parameter data set in permanent memory</p> <p>'3' Operating parameter data set in volatile memory</p> <p>Permissible combinations here include:</p> <p>'03' Copying the data set from the permanent memory to the operating parameter data set</p> <p>'30' Copying the operating parameter data set to the permanent parameter set memory</p> <p>'20' Copying the default parameters to the permanent memory and to the main memory</p>
Acknowledgment	<p>'PS=<aa>'</p> <p><aa> Status acknowledgment, unit [dimensionless]</p> <p>'00' Ok</p> <p>'01' Syntax error</p> <p>'02' Impermissible command length</p> <p>'03' Reserved</p> <p>'04' Reserved</p> <p>'05' Reserved</p> <p>'06' Impermissible combination, source type - target type</p>

Requesting parameter data set from BCL 358*i*

Command	'PR'
Description	<p>The parameters of the BCL 358<i>i</i> are grouped together in a parameter set and permanently stored in memory. There is one parameter set in permanent memory and one operating parameter set in volatile memory; in addition, there is a default parameter set (factory parameter set) for initialization. This command can be used to edit the first two parameter sets (in permanent and volatile memory). A check sum can be used for reliable parameter transfer.</p>
Parameter	<p>'PR<BCC type><PS type><Address><Data length>[<BCC>'] <BCC type> Check-digit function during transfer, unit [dimensionless] '0' Not used '3' BCC mode 3 <PS type> Memory from which the values are to be read, unit [dimensionless] '0' Parameter values stored in the flash memory '1' Reserved '2' Default values '3' Operating values in RAM <Address> Relative address of the data within the data set 'aaaa' Four-digit, unit [dimensionless] <Data length> Length of the parameter data to be transferred 'bbbb' Four-digit, unit [length in bytes] <BCC> Check sum calculated as specified under BCC type</p>

Command	'PR'
<p>Acknowledgment positive</p>	<p>PT<BCC type><PS type><Status><Start> <Address parameter value><Address+1 parameter value>... [<Address><Address parameter value>][<BCC>] <BCC type> Check-digit function during transfer, unit [dimensionless] '0' Not used '3' BCC mode 3 <PS type> Memory from which the values are to be read, unit [dimensionless] '0' Parameter values stored in the flash memory '2' Default values '3' Operating values in RAM <Status> Mode of parameter processing, unit [dimensionless] '0' No further parameters '1' Additional parameters follow <Start> Relative address of the data within the data set, 'aaaa' Four-digit, unit [dimensionless] <P.value A.> Parameter value of the parameter stored at this address; the parameter set data 'bb' is converted from HEX format to a 2-byte ASCII-format for transfer. <BCC> Check sum calculated as specified under BCC type</p>
<p>Acknowledgment negative</p>	<p>'PS=<aa>' Parameter reply: <aa> Status acknowledgment, unit [dimensionless] '01' Syntax error '02' Impermissible command length '03' Impermissible value for checksum type '04' Invalid check sum received '05' Impermissible number of data requested '06' Requested data does not (any longer) fit in the transmis- sion buffer '07' Impermissible address value '08' Read access after end of data set '09' Impermissible QPF data set type</p>

Determining parameter set difference to default parameters

Command	'PD'
<p>Description</p>	<p>This command outputs the difference between the default parameter set and the operating parameter set or the difference between the default parameter set and the permanent parameter set.</p> <p>Comment: The reply supplied by this command can e.g. be directly used for programming a device with factory settings, whereby this device receives the same configuration as the device on which the PD-sequence was executed.</p>
<p>Parameter</p>	<p>'PD<P.set1><P.set2>' <P.set1> Parameter data set which is to be copied, unit [dimensionless] '0' Parameter data set in permanent memory '2' Default or factory parameter set <P.set2> Parameter set to which the data is to be copied, unit [dimensionless] '0' Parameter data set in permanent memory '3' Operating parameter data set in volatile memory Permissible combinations here include: '20' Output of the parameter differences between the default and the permanently saved parameter set '23' Output of the parameter differences between the default parameter set and the operating parameter set saved in volatile memory '03' Output of the parameter differences between the permanent parameter set and the operating parameter set saved in volatile memory</p>
<p>Acknowledgment positive</p>	<p>PT<BCC><PS type><Status><Adr.><P.value adr.><P.valueAdr.+1>... [;<Adr.><P.value adr.>] <BCC> '0' No check digit '3' BCC mode 3 <PS type> '0' Values stored in flash memory '3' Operating values stored in RAM <Status> '0' No further parameters '1' Additional parameters follow <Adr.> Relative address of the data within the data set 'aaaa' Four-digit, unit [dimensionless] <P.value> Parameter value of the -bb- parameter stored at this address. The parameter set data is converted from HEX format to a 2-byte-ASCII format for transfer.</p>

Command	'PD'
Acknowledgment negative	'PS=<aa>'
	<aa> Status acknowledgment, unit [dimensionless]
	'0' No difference
	'1' Syntax error
	'2' Impermissible command length
	'6' Impermissible combination, parameter set 1 and parameter set 2
'8' Invalid parameter set	

Writing parameter set

Command	'PT'
Description	<p>The parameters of the BCL 358<i>i</i> are grouped together in a parameter set and permanently stored in memory. There is one parameter set in permanent memory and one operating parameter set in volatile memory; in addition, there is a default parameter set (factory parameter set) for initialization. This command can be used to edit the first two parameter sets (in permanent and volatile memory). A check sum can be used for reliable parameter transfer.</p>
Parameter	<p>PT<BCC type><PS type><Status><Adr.><P.value adr.><P.value adr+1>...[:<Adr.><P.value adr.>][<BCC>]</p> <p><BCC type> Check-digit function during transfer, unit [dimensionless]</p> <p>'0' No check digit</p> <p>'3' BCC mode 3</p> <p><PS type> Memory from which the values are to be read, unit [dimensionless]</p> <p>'0' Parameter values stored in the flash memory</p> <p>'3' Operating values stored in RAM</p> <p><Status> Mode of parameter processing, without function here, unit [dimensionless]</p> <p>'0' No reset after parameter change, no further parameters</p> <p>'1' No reset after parameter change, additional parameters follow</p> <p>'2' With reset after parameter change, no further parameters</p> <p>'6' Set parameters to factory setting, no further parameters</p> <p>'7' Set parameters to factory settings, lock all code types; the code-type setting must follow in the command!</p> <p><Adr.> Relative address of the data within the data set, 'aaaa' Four-digit, unit [dimensionless]</p> <p><P.value> Parameter value of the -bb- parameter stored at this address. The parameter set data is converted from HEX format to a 2-byte-ASCII format for transfer.</p> <p><BCC> Check sum calculated as specified under BCC type</p>

Command	'PT'
Acknowledgment	'PS=<aa>'
	Parameter reply:
	<aa> Status acknowledgment, unit [dimensionless]
	'01' Syntax error
	'02' Impermissible command length
	'03' Impermissible value for checksum type
	'04' Invalid check sum received
	'05' Impermissible data length
	'06' Invalid data (parameter limits violated)
	'07' Invalid start address
'08' Invalid parameter set	
'09' Invalid parameter set type	

12 Diagnostics and troubleshooting

12.1 General causes of errors

Error	Possible error cause	Measures
Status LED PWR		
Off	<ul style="list-style-type: none"> No supply voltage connected to the device Hardware error 	<input type="checkbox"/> Check supply voltage <input type="checkbox"/> Send device to customer service
Red, flashing	<ul style="list-style-type: none"> Warning 	<input type="checkbox"/> Query diagnostic data and carry out the resulting measures
Red, continuous light	<ul style="list-style-type: none"> Error: no function possible 	<input type="checkbox"/> Internal device error, send in device
Orange, continuous light	<ul style="list-style-type: none"> Device in service mode 	<input type="checkbox"/> Reset service mode with webConfig tool
Status LED NET		
Off	<ul style="list-style-type: none"> No supply voltage connected to the device No IP address assigned Hardware error 	<input type="checkbox"/> Check supply voltage <input type="checkbox"/> IP address assigned <input type="checkbox"/> Send device to customer service
Red, flashing	<ul style="list-style-type: none"> Communication error 	<input type="checkbox"/> Check interface
Red, continuous light	<ul style="list-style-type: none"> Double IP address 	<input type="checkbox"/> Check network configuration

Table 12.1: General causes of errors

12.2 Interface errors

Error	Possible error cause	Measures
No communication via USB service interface	<ul style="list-style-type: none"> Incorrect connection cable Connected BCL 358/i is not detected 	<input type="checkbox"/> Check connection cable <input type="checkbox"/> Install USB driver
Sporadic errors at the Ethernet interface	<ul style="list-style-type: none"> Incorrect wiring Effects due to EMC Overall network expansion exceeded 	<input type="checkbox"/> Check wiring <ul style="list-style-type: none"> In particular, check wire shielding Check the cable used <input type="checkbox"/> Check shielding (shield covering in place up to the clamping point) <input type="checkbox"/> Check grounding concept and connection to functional earth (FE) <input type="checkbox"/> Avoid EMC coupling caused by power cables laid parallel to device lines. <input type="checkbox"/> Check max. network expansion as a function of the max. cable lengths

Table 12.2: Interface error

**Notice!**

Please use **chapter 12 as a master copy** should servicing be required.

Cross the items in the "Measures" column which you have already examined, fill out the following address field and fax the pages together with your service contract to the fax number listed below.

Customer data (please complete)

Device type:	
Company:	
Contact partner / department:	
Phone (direct):	
Fax:	
Street / No:	
ZIP code/City:	
Country:	

Leuze Service fax number:

+49 7021 573 - 199

13 Type overview and accessories

13.1 Part number code

BCL 300i OM100D H	
Heating option	H = With heating
Display option	D = With display and two control button
Beam exit	0 Lateral
	2 Front
Optics	N High Density (near)
	M Medium Density (medium distance)
	F Low Density (remote)
	L Long Range (very large distances)
Scanning principle	S Line scanner (single line)
	R1 Line scanner (raster)
	O Oscillating-mirror scanner
Interface	<i>i</i> = Integrated fieldbus technology
	00 RS 232/RS 422 (standalone)
	01 RS 485 (multiNet Slave)
	04 PROFIBUS DP
	08 ETHERNET TCP/IP, UDP
	48 PROFINET-IO RT
58 EtherNet/IP	
BCL Bar code reader	

Table 13.1: Part number code BCL 358*i*

13.2 Type overview BCL 358*i*

Network participants with 2x EtherNet/IP interface:

Type designation	Description	Part no.
Single line scanner with frontal beam exit		
BCL 358/ S N 102	with N optics	50120793
BCL 358/ S M 102	with M optics	50120787
BCL 358/ S F 102	with F optics	50120775
BCL 358/ S L 102	with L optics	50120781
BCL 358/ S N 102 D	with N optics and display	50120794
BCL 358/ S M 102 D	with M optics and display	50120788
BCL 358/ S F 102 D	with F optics and display	50120776
BCL 358/ S L 102 D	with L optics and display	50120782
BCL 358/ S N 102 D H	with N optics, display and heating	50120795
BCL 358/ S M 102 D H	with M optics, display and heating	50120789
BCL 358/ S F 102 D H	with F optics, display and heating	50120777
BCL 358/ S L 102 D H	with L optics, display and heating	50120783
Raster scanner with frontal beam exit		
BCL 358/ R1 N 102	with N optics	50120770
BCL 358/ R1 M 102	with M optics	50120766
BCL 358/ R1 F 102	with F optics	50120762
BCL 358/ R1 N 102 D	with N optics and display	50120771
BCL 358/ R1 M 102 D	with M optics and display	50120767
BCL 358/ R1 F 102 D	with F optics and display	50120763
Single line scanner with deflection mirror		
BCL 358/ S N 100	with N optics	50120790
BCL 358/ S M 100	with M optics	50120784
BCL 358/ S F 100	with F optics	50120772
BCL 358/ S L 100	with L optics	50120778
BCL 358/ S N 100 D	with N optics and display	50120791
BCL 358/ S M 100 D	with M optics and display	50120785
BCL 358/ S F 100 D	with F optics and display	50120773
BCL 358/ S L 100 D	with L optics and display	50120779
BCL 358/ S N 100 D H	with N optics, display and heating	50120792
BCL 358/ S M 100 D H	with M optics, display and heating	50120786
BCL 358/ S F 100 D H	with F optics, display and heating	50120774
BCL 358/ S L 100 D H	with L optics, display and heating	50120780
Raster scanner with deflection mirror		
BCL 358/ R1 N 100	with N optics	50120768
BCL 358/ R1 M 100	with M optics	50120764
BCL 358/ R1 F 100	with F optics	50120760
BCL 358/ R1 N 100 D	with N optics and display	50120769
BCL 358/ R1 M 100 D	with M optics and display	50120765
BCL 358/ R1 F 100 D	with F optics and display	50120761
Oscillating mirror scanner		
BCL 358/ O M 100	with M optics	50120754
BCL 358/ O F 100	with F optics	50120748
BCL 358/ O L 100	with L optics	50120751
BCL 358/ O M 100 D	with M optics and display	50120755
BCL 358/ O F 100 D	with F optics and display	50120749
BCL 358/ O L 100 D	with L optics and display	50120752
BCL 358/ O M 100 D H	with M optics, display and heating	50120756
BCL 358/ O F 100 D H	with F optics, display and heating	50120750
BCL 358/ O L 100 D H	with L optics, display and heating	50120753

Table 13.2: Type overview BCL 358*i*

13.3 Accessory connection hoods

Type designation	Description	Part no.
MS 358	Hood with integrated connectors for BCL 358 <i>i</i>	50120797
MK 358	Terminal hood for BCL 358 <i>i</i>	50120796

Table 13.3: Connection hoods for the BCL 358*i*

13.4 Accessory connectors

Type designation	Description	Part no.
KD 095-5A	M12 axial socket for voltage supply, shielded	50020501
D-ET1	RJ45 connector for user-configuration	50108991
S-M12A-ET	Axial M12 connector, D-coded, for self-assembly	50112155
KDS ET M12 / RJ 45 W - 4P	Converter from M12 D-coded to RJ 45 socket	50109832

Table 13.4: Connectors for the BCL 358*i*

13.5 Accessory USB cable

Type designation	Description	Part no.
KB USBa-USBminiB	USB service cable, 2 type A and Mini-B type connectors, length 1m	50117011

Table 13.5: Service cable for the BCL 358*i*

13.6 Accessory mounting device

Type designation	Description	Part no.
BT 56	Mounting device for rod	50027375
BT 59	Mounting device for ITEM	50111224

Table 13.6: Mounting devices for the BCL 358*i*

13.7 Reflector accessories for autoRefIAct

Type designation	Description	Part no.
Reflective tape no. 4 / 100 x 100 mm	Reflective tape as reflector for autoRefIAct operation	50106119

Table 13.7: Reflector for autoRefIAct operation

13.8 Accessory ready-made cables for voltage supply

13.8.1 Contact assignment of PWR connection cable

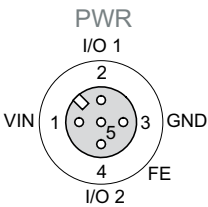
PWR connection cable (5-pin socket, A-coded, not shielded)			
 <p>PWR I/O 1 2 VIN 1 3 GND 4 I/O 2 FE M12 socket (A-coded)</p>	Pin	Name	Core color
	1	VIN	brown
	2	I/O 1	white
	3	GND	blue
	4	I/O 2	black
	5	FE	gray
Thread	FE	bare	



Notice!

These cables are not shielded.

13.8.2 Specifications of the cables for voltage supply

Operating temperature range	in rest state:	-30°C ... +70°C
	in motion:	5°C ... +70°C
Material	sheathing:	PVC
Bending radius		> 50mm

13.8.3 Order codes of the cables for voltage supply

Type designation	Description	Part no.
K-D M12A-5P-5m-PVC	M12 socket for PWR, axial connector, open cable end, cable length 5m, not shielded	50104557
K-D M12A-5P-10m-PVC	M12 socket for PWR, axial plug outlet, open cable end, cable length 10m, not shielded	50104559

Table 13.8: PWR cables for the BCL 358*i*

13.9 Accessory ready-made cables for bus connection

13.9.1 General information

- Cable **KB ET...** for connecting to EtherNet/IP via M12 connector
- Standard cable available in lengths from 2 ... 30m
- Special cables on request.

13.9.2 Contact assignments M12 EtherNet/IP connection cables KB ET...

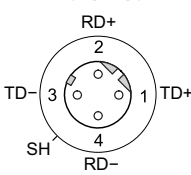
M12 Ethernet connection cables (4-pin connector, D-coded, on both sides)			
Ethernet	Pin	Name	Core color
 <p>M12 plug (D-coded)</p>	1	TD+	yellow
	2	RD+	white
	3	TD-	orange
	4	RD-	blue
	SH (thread)	FE	bare

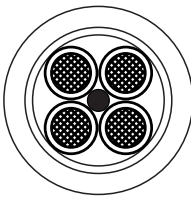

Core colors

WH
YE
BU
OG

Conductor class: VDE 0295, EN 60228, IEC 60228 (Class 5)



Shielding contact via connector housing!

Figure 13.9: Cable structure of EtherNet/IP connection cables

13.9.3 Specifications of the M12 EtherNet/IP connection cables KB ET...

Operating temperature range in rest state: -50°C ... +80°C
 in motion: -25°C ... +80°C
 in motion: -25°C ... +60°C (when used with drag chains)

Material cable sheath: PUR (green), wire insulation: PE foam, free of halogens, silicone and PVC

Bending radius > 65mm, suitable for drag chains
Bending cycles > 10⁶, perm. acceleration < 5m/s²

13.9.4 Order codes for M12 EtherNet/IP connection cables KB ET...

Type designation	Description	Part no.
M12 plug for BUS IN, axial connector, open cable end		
KB ET - 1000 - SA	Cable length 1m	50106738
KB ET - 2000 - SA	Cable length 2m	50106739
KB ET - 5000 - SA	Cable length 5m	50106740
KB ET - 10000 - SA	Cable length 10m	50106741
KB ET - 15000 - SA	Cable length 15m	50106742
KB ET - 20000 - SA	Cable length 20m	50106743
KB ET - 25000 - SA	Cable length 25m	50106745
KB ET - 30000 - SA	Cable length 30m	50106746
M12 plug for BUS IN to RJ-45 connector		
KB ET - 1000 - SA-RJ45	Cable length 1m	50109879
KB ET - 2000 - SA-RJ45	Cable length 2m	50109880
KB ET - 5000 - SA-RJ45	Cable length 5m	50109881
KB ET - 10000 - SA-RJ45	Cable length 10m	50109882
KB ET - 15000 - SA-RJ45	Cable length 15m	50109883
KB ET - 20000 - SA-RJ45	Cable length 20m	50109884
KB ET - 25000 - SA-RJ45	Cable length 25m	50109885
KB ET - 30000 - SA-RJ45	Cable length 30m	50109886
M12 plug + M12 plug for BUS OUT to BUS IN		
KB ET - 1000 - SSA	Cable length 1m	50106898
KB ET - 2000 - SSA	Cable length 2m	50106899
KB ET - 5000 - SSA	Cable length 5m	50106900
KB ET - 10000 - SSA	Cable length 10m	50106901
KB ET - 15000 - SSA	Cable length 15m	50106902
KB ET - 20000 - SSA	Cable length 20m	50106903
KB ET - 25000 - SSA	Cable length 25m	50106904
KB ET - 30000 - SSA	Cable length 30m	50106905

Table 13.10: Bus connection cables for the BCL 358*i*

14 Maintenance

14.1 General maintenance information

Usually, the bar code reader BCL 358*i* does not require any maintenance by the operator.

Cleaning

Clean glass surface with a damp sponge soaked in commercial cleaning detergent. Then rub it with a soft, clean, dry cloth.



Notice!

Do not use aggressive cleaning agents such as thinner or acetone for cleaning the device. Use of improper cleaning agents can damage the housing window.

14.2 Repairs, servicing

Repairs to the device must only be carried out by the manufacturer.

↳ *Contact your Leuze distributor or service organization should repairs be required. The addresses can be found on the inside of the cover and on the back.*



Notice!

When sending devices to Leuze electronic for repair, please provide an accurate description of the error.

14.3 Disassembling, packing, disposing

Repacking

For later reuse, the device is to be packed so that it is protected.



Notice!

Electrical scrap is a special waste product! Observe the locally applicable regulations regarding disposal of the product.

15 Appendix

15.1 Declaration of Conformity



 the sensor people		
EG-KONFORMITÄTS- ERKLÄRUNG	EC DECLARATION OF CONFORMITY	DECLARATION CE DE CONFORMITE
Der Hersteller	The Manufacturer	Le constructeur
	Leuze electronic GmbH + Co. KG In der Braike 1, PO Box 1111 73277 Owen, Germany	
erklärt, dass die nachfolgend aufgeführten Produkte den einschlägigen Anforderungen der genannten EG-Richtlinien entsprechen.	declares that the following listed products fulfil the relevant provisions of the mentioned EC Directives.	déclare que les produits identifiés suivants sont conformes aux directives CE mentionnées.
Produktbeschreibung:	Description of product:	Description de produit:
Stationärer Barcodeser BCL 3xxi	Stationary Barcode Reader BCL 3xxi	Lecteurs Stationn. de Code à Barres BCL 3xxi
Angewandte EG-Richtlinie(n):	Applied EC Directive(s):	Directive(s) CE appliquées:
2004/108/EG 2006/95/EG	2004/108/EC 2006/95/EC	2004/108/CE 2006/95/CE
Angewandte Normen:	Applied standards:	Normes appliquées:
EN 61000-6-2: 2005 EN 60825-1: 2007		EN 61000-6-3: 2007
<div style="display: flex; justify-content: space-around; align-items: center;"> <div style="text-align: center;"> <p><i>24.8.2011</i></p> <p>Datum / Date / Date</p> </div> <div style="text-align: center;">  <p>Dr. Harald Gröbel, Geschäftsführer / Director / Directeur</p> </div> </div>		
Leuze electronic GmbH + Co. KG In der Braike 1 D-73277 Owen Telefon +49 (0) 7021 973-0 Telefax +49 (0) 7021 973-199 info@leuze.de www.leuze.com LEO-ZQM-148-01-FO	Leuze electronic GmbH + Co. KG, Sitz: Owen, Registergericht Stuttgart, HRB 230712 Persönlich haftende Gesellschafterin Leuze electronic Geschäftsführungs-GmbH, Sitz: Owen, Registergericht Stuttgart, HRB 230550 Geschäftsführer: Dr. Harald Gröbel (Vorstand), Karsten Just USt-IdNr.: DE 145812321 Zollnummer 254232 Es gelten ausschließlich unsere aktuellen Verkaufs- und Lieferbedingungen Only our current Terms and Conditions of Sale and Delivery shall apply	

Figure 15.1: Declaration of conformity BCL 358*i*

 the sensor people		
EG-KONFORMITÄTS- ERKLÄRUNG	EC DECLARATION OF CONFORMITY	DECLARATION CE DE CONFORMITE
Der Hersteller	The Manufacturer	Le constructeur
	Leuze electronic GmbH + Co. KG In der Braike 1, PO Box 1111 73277 Owen, Germany	
erklärt, dass die nachfolgend aufgeführten Produkte den einschlägigen Anforderungen der genannten EG-Richtlinien entsprechen.	declares that the following listed products fulfill the relevant provisions of the mentioned EC Directives.	déclare que les produits identifiés suivants sont conformes aux directives CE mentionnées.
Produktbeschreibung:	Description of product:	Description de produit:
Modulare Steckerhaube MS 3xx, Modulare Klemmhaube MK 3xx, Modulare Anschlusseinheit MA 100	Modular hood with integrated connectors MS 3xx, Modular terminal hoods MK 3xx, Modular interfacing unit MA 100	Logement modulaire de prises MS 3xx, Logement modulaire de bornes MK 3xx, Unité modulaire de branchement MA 100
Angewandte EG-Richtlinie(n):	Applied EC Directive(s):	Directive(s) CE appliquées:
2004/108/EG	2004/108/EC	2004/108/CE
Angewandte Normen:	Applied standards:	Normes appliquées:
EN 61000-6-2: 2005		EN 61000-6-4: 2007
<div style="display: flex; justify-content: space-around; align-items: center;"> <div style="text-align: center;">  Datum / Date / Date </div> <div style="text-align: center;">  Dr. Harald Gruber, Geschäftsführer / Director / Directeur </div> </div>		
Leuze electronic GmbH + Co. KG In der Braike 1 D-73277 Owen Telefon +49 (0) 7021 573-0 Telefax +49 (0) 7021 573-199 info@leuze.de www.leuze.com LEO-ZQM-148-01-FO	Leuze electronic GmbH + Co. KG, Sitz Owen, Registergericht Stuttgart, HRA 230712 Persönlich haftende Gesellschafterin Leuze electronic Geschäftsführungs GmbH, Sitz Owen, Registergericht Stuttgart, HRB 20060 Geschäftsführer: Dr. Harald Gruber (Vorsitzender), Kersten Just USt-IdNr. DE 140912021 Zolnummer 2004202 Es gelten ausschließlich unsere aktuellen Verkaufs- und Lieferbedingungen Only our current Terms and Conditions of Sale and Delivery shall apply	

Figure 15.2: Connection hood / connector unit declaration of conformity

15.2 ASCII character set

ASCII	Dec.	Hex.	Oct.	Designation	Meaning
NUL	0	00	0	NULL	Zero
SOH	1	01	1	START OF HEADING	Start of heading
STX	2	02	2	START OF TEXT	Start of text characters
ETX	3	03	3	END OF TEXT	Last character of text
EOT	4	04	4	END OF TRANSMISS.	End of transmission
ENQ	5	05	5	ENQUIRY	Request for data trans.
ACK	6	06	6	ACKNOWLEDGE	Positive acknowledgment
BEL	7	07	7	BELL	Bell signal
BS	8	08	10	BACKSPACE	Backspace
HT	9	09	11	HORIZ. TABULATOR	Horizontal tabulator
LF	10	0A	12	LINE FEED	Line feed
VT	11	0B	13	VERT. TABULATOR	Vertical tabulator
FF	12	0C	14	FORM FEED	Form feed
CR	13	0D	15	CARRIAGE RETURN	Carriage return
SO	14	0E	16	SHIFT OUT	Shift out
SI	15	0F	17	SHIFT IN	Shift in
DLE	16	10	20	DATA LINK ESCAPE	Data link escape
DC1	17	11	21	DEVICE CONTROL 1	Device control character 1
DC2	18	12	22	DEVICE CONTROL 2	Device control character 2
DC3	19	13	23	DEVICE CONTROL 3	Device control character 3
DC4	20	14	24	DEVICE CONTROL 4	Device control character 4
NAK	21	15	25	NEG. ACKNOWLEDGE	Negative acknowledge
SYN	22	16	26	SYNCHRONOUS IDLE	Synchronization
ETB	23	17	27	EOF TRANSM. BLOCK	End of data transmission block
CAN	24	18	30	CANCEL	Invalid
EM	25	19	31	END OF MEDIUM	End of medium
SUB	26	1A	32	SUBSTITUTE	Substitution
ESC	27	1B	33	ESCAPE	Escape
FS	28	1C	34	FILE SEPARATOR	File separator
GS	29	1D	35	GROUP SEPARATOR	Group separator
RS	30	1E	36	RECORD SEPARATOR	Record separator
US	31	1F	37	UNIT SEPARATOR	Unit separator
SP	32	20	40	SPACE	Space
!	33	21	41	EXCLAMATION POINT	Exclamation point

ASCII	Dec.	Hex.	Oct.	Designation	Meaning
"	34	22	42	QUOTATION MARK	Quotation mark
#	35	23	43	NUMBER SIGN	Number sign
\$	36	24	44	DOLLAR SIGN	Dollar sign
%	37	25	45	PERCENT SIGN	Percent sign
&	38	26	46	AMPERSAND	Ampersand
'	39	27	47	APOSTROPHE	Apostrophe
(40	28	50	OPEN. PARENTHESIS	Open parenthesis
)	41	29	51	CLOS. PARENTHESIS	Closed parenthesis
*	42	2A	52	ASTERISK	Asterisk
+	43	2B	53	PLUS	Plus sign
,	44	2C	54	COMMA	Comma
-	45	2D	55	HYPHEN (MINUS)	Hyphen
.	46	2E	56	PERIOD (DECIMAL)	Period (decimal)
/	47	2F	57	SLANT	Slant
0	48	30	60	0	Number
1	49	31	61	1	Number
2	50	32	62	2	Number
3	51	33	63	3	Number
4	52	34	64	4	Number
5	53	35	65	5	Number
6	54	36	66	6	Number
7	55	37	67	7	Number
8	56	38	70	8	Number
9	57	39	71	9	Number
:	58	3A	72	COLON	Colon
;	59	3B	73	SEMICOLON	Semicolon
<	60	3C	74	LESS THAN	Less than
=	61	3D	75	EQUALS	Equals
>	62	3E	76	GREATER THAN	Greater than
?	63	3F	77	QUESTION MARK	Question mark
@	64	40	100	COMMERCIAL AT	Commercial AT
A	65	41	101	A	Capital letter
B	66	42	102	B	Capital letter
C	67	43	103	C	Capital letter
D	68	44	104	D	Capital letter

ASCII	Dec.	Hex.	Oct.	Designation	Meaning
E	69	45	105	E	Capital letter
F	70	46	106	F	Capital letter
G	71	47	107	G	Capital letter
H	72	48	110	H	Capital letter
I	73	49	111	I	Capital letter
J	74	4A	112	J	Capital letter
K	75	4B	113	K	Capital letter
L	76	4C	114	L	Capital letter
M	77	4D	115	M	Capital letter
N	78	4E	116	N	Capital letter
O	79	4F	117	O	Capital letter
P	80	50	120	P	Capital letter
Q	81	51	121	Q	Capital letter
R	82	52	122	R	Capital letter
S	83	53	123	S	Capital letter
T	84	54	124	T	Capital letter
U	85	55	125	U	Capital letter
V	86	56	126	V	Capital letter
W	87	57	127	W	Capital letter
X	88	58	130	X	Capital letter
Y	89	59	131	Y	Capital letter
Z	90	5A	132	Z	Capital letter
[91	5B	133	OPENING BRACKET	Opening bracket
\	92	5C	134	REVERSE SLANT	Reverse slant
]	93	5D	135	CLOSING BRACKET	Closing bracket
^	94	5E	136	CIRCUMFLEX	Circumflex
_	95	5F	137	UNDERSCORE	Underscore
`	96	60	140	GRAVE ACCENT	Grave accent
a	97	61	141	a	Lower case letter
b	98	62	142	b	Lower case letter
c	99	63	143	c	Lower case letter
d	100	64	144	d	Lower case letter
e	101	65	145	e	Lower case letter
f	102	66	146	f	Lower case letter
g	103	67	147	g	Lower case letter

ASCII	Dec.	Hex.	Oct.	Designation	Meaning
h	104	68	150	h	Lower case letter
i	105	69	151	i	Lower case letter
j	106	6A	152	j	Lower case letter
k	107	6B	153	k	Lower case letter
l	108	6C	154	l	Lower case letter
m	109	6D	155	m	Lower case letter
n	110	6E	156	n	Lower case letter
o	111	6F	157	o	Lower case letter
p	112	70	160	p	Lower case letter
q	113	71	161	q	Lower case letter
r	114	72	162	r	Lower case letter
s	115	73	163	s	Lower case letter
t	116	74	164	t	Lower case letter
u	117	75	165	u	Lower case letter
v	118	76	166	v	Lower case letter
w	119	77	167	w	Lower case letter
x	120	78	170	x	Lower case letter
y	121	79	171	y	Lower case letter
z	122	7A	172	z	Lower case letter
{	123	7B	173	OPENING BRACE	Opening brace
	124	7C	174	VERTICAL LINE	Vertical line
}	125	7D	175	CLOSING BRACE	Closing brace
~	126	7E	176	TILDE	Tilde
DEL	127	7F	177	DELETE (RUBOUT)	Delete

15.3 Bar code samples

15.3.1 Module 0.3

Code type 01: Interleaved 2 of 5

Modul 0,3



1122334455

Code type 02: Code 39

Modul 0,3



135A C

Code type 11: Codabar

Modul 0,3

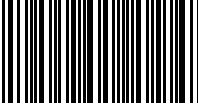

A121314A

Code 128

Modul 0,3

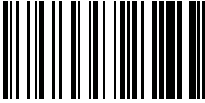

abcde

Code type 08: EAN 128

Modul 0,3

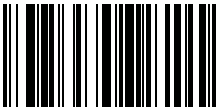

leuze

Code type 06: UPC-A

SC 2



1 23456 78901 2

Code type 07: EAN 8

SC 3

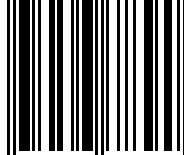

3456 7890

Code type 10: EAN 13 Add-on

SC 0

S



1 122334 455666 77889

Code type 13: GS1 DataBar OMNIDIRECTIONAL



(01) 0 0000123 45678 4

Figure 15.3: Bar code sample labels (module 0.3)

15.3.2 Module 0.5

Code type 01: Interleaved 2 of 5

Modul 0,5



Code type 02: Code 39

Modul 0,5



Code type 11: Codabar

Modul 0,5



Code 128

Modul 0,5



Code type 08: EAN 128

Modul 0,5



Code type 06: UPC-A

SC 4



Code type 07: EAN 8

SC 6



Code type 10: EAN 13 Add-on

SC 2



Figure 15.4: Bar code sample labels (module 0.5)