

Technical data sheet

Safety laser scanner

Part no.: 53800312

RSL450P-S/CU400P-3M12

Contents

- Technical data
- Dimensioned drawings
- Electrical connection
- Operation and display
- Notes
- Accessories



Figure can vary



Technical data

Basic data

Series	RSL 400
Application	Mobile danger zone guarding Mobile side guarding Stationary access guarding Stationary danger zone guarding

Functions

Functions	Data output, configurable Four-field mode PROFIsafe Resolution, selectable
-----------	---

Characteristic parameters

Type	3, IEC/EN 61496
SIL	2, IEC 61508
SILCL	2, IEC/EN 62061
Performance Level (PL)	d, EN ISO 13849-1
PFH _D	9E-08 per hour
Mission time T _M	20 years, EN ISO 13849-1
Category	3, EN ISO 13849

Protective field data

Scanning angle	270 °
Minimum adjustable range	50 mm
Number of field pairs, reversible	Up to 100
Number of quads, reversible	50
Number of protective functions	2 Piece(s)
Number of independent sensor configurations	Up to 10
Diffuse reflection, min.	1.8 %
Operating range	0 ... 3 m

Warning field data

Number of field pairs	Up to 100
Operating range	0 ... 20 m
Object size	150 mm x 150 mm
Diffuse reflection, min.	10 %

Optical data

Light source	Laser, Infrared
Laser light wavelength	905 nm
Laser class	1, IEC/EN 60825-1:2007
Transmitted-signal shape	Pulsed
Repetition frequency	90 kHz

Measurement data

Distance resolution	1 mm
Detection range	0 ... 50 m
Diffuse reflection	20 %
Angular resolution	0.1 °

Electrical data

Protective circuit	Overvoltage protection
--------------------	------------------------

Performance data

Supply voltage U _B	24 V, DC, -30 ... 20 %
Current consumption (without load), max.	900 mA, (use power supply unit with 3 A)
Power consumption, max.	22 W, For 24 V, plus output load

Interface

Type	PROFINET
Profinet	
Function	Process
PROFINET device	Device acc. to Spec V2.3.4
GSDML	GSDML acc. to Spec V2.3.2
Profile	PROFINET/PROFIsafe
Conformance class	C
Network load class	III
Security level	1
Switch functionality	IRT-ready 2-port switch acc. to IEEE 802, integrated in connection unit
Port properties	
	Auto-Crossover Auto-Negotiation Auto-Polarity
I&M	0 - 4
Supported topologies	MRP client SNMP
Safety-related switching signals	4 Piece(s)

Service interface

Type	Bluetooth, USB
Bluetooth	
Function	Configuration/parametering
Frequency band	2,400 ... 2,483.5 MHz
Radiated transmitting power	Max. 4.5 dBm (2.82 mW), class 2
USB	
Function	Configuration/parametering
Connection	USB 2.0 mini-B, socket
Transmission speed, max.	12 Mbit/s
Cable length	≤ 5m Longer cable lengths are possible using active cables.

Connection

Number of connections	3 Piece(s)
Connection 1	
Function	Voltage supply
Type of connection	Connector
Thread size	M12
Type	Male
Material	Metal
No. of pins	4 -pin
Encoding	A-coded

Technical data

Connection 2

Function	PROFINET/PROFIsafe communication, input
Type of connection	Connector
Thread size	M12
Type	Female
Material	Metal
No. of pins	4 -pin
Encoding	D-coded

Connection 3

Function	PROFINET/PROFIsafe communication, output
Type of connection	Connector
Thread size	M12
Type	Female
Material	Metal
No. of pins	4 -pin
Encoding	D-coded

Mechanical data

Dimension (W x H x L)	140.2 mm x 170 mm x 142 mm
Housing material	Metal Plastic
Metal housing	Diecast zinc
Lens cover material	Plastic/PC
Net weight	4,300 g
Housing color	Yellow, RAL 1021
Type of fastening	Mounting plate Through-hole mounting Via optional mounting device

Operation and display

Type of display	Alphanumeric display LED indicator
Number of LEDs	11 Piece(s)
Type of configuration	Software Sensor Studio
Operational controls	Software Sensor Studio

Environmental data

Ambient temperature, operation	0 ... 50 °C
Ambient temperature, storage	-20 ... 60 °C
Relative humidity (non-condensing)	15 ... 95 %

Certifications

Degree of protection	IP 65
Protection class	III, EN 61140
Certifications	TÜV Süd
Test procedure for EMC in accordance with standard	DIN 40839-1/3 EN 61496-1
Test procedure for oscillation in accordance with standard	EN 60068-2-6
Test procedure for continuous shock in accordance with standard	IEC 60068-2-29
US patents	US 10,304,307B US 7,656,917 B US 7,696,468 B US 8,520,221 B

Classification

Customs tariff number	85365019
eCl@ss 5.1.4	27272705
eCl@ss 8.0	27272705
eCl@ss 9.0	27272705
eCl@ss 10.0	27272705
eCl@ss 11.0	27272705
ETIM 5.0	EC002550
ETIM 6.0	EC002550
ETIM 7.0	EC002550

Dimensioned drawings

All dimensions in millimeters

Dimensions safety laser scanner with connection unit

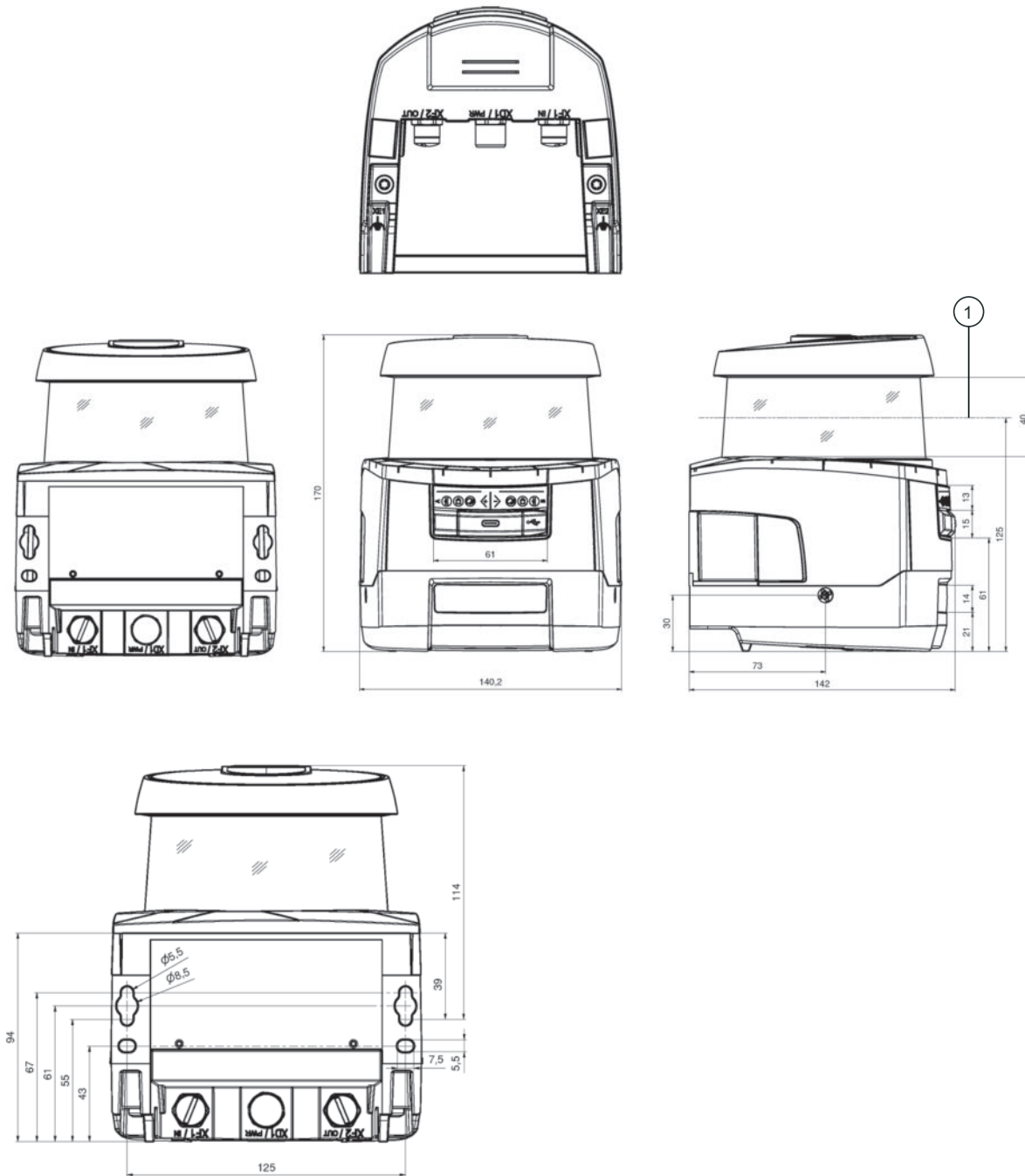

1 Scan level

Dimensioned drawings

Mounting dimensions safety laser scanner with connection unit

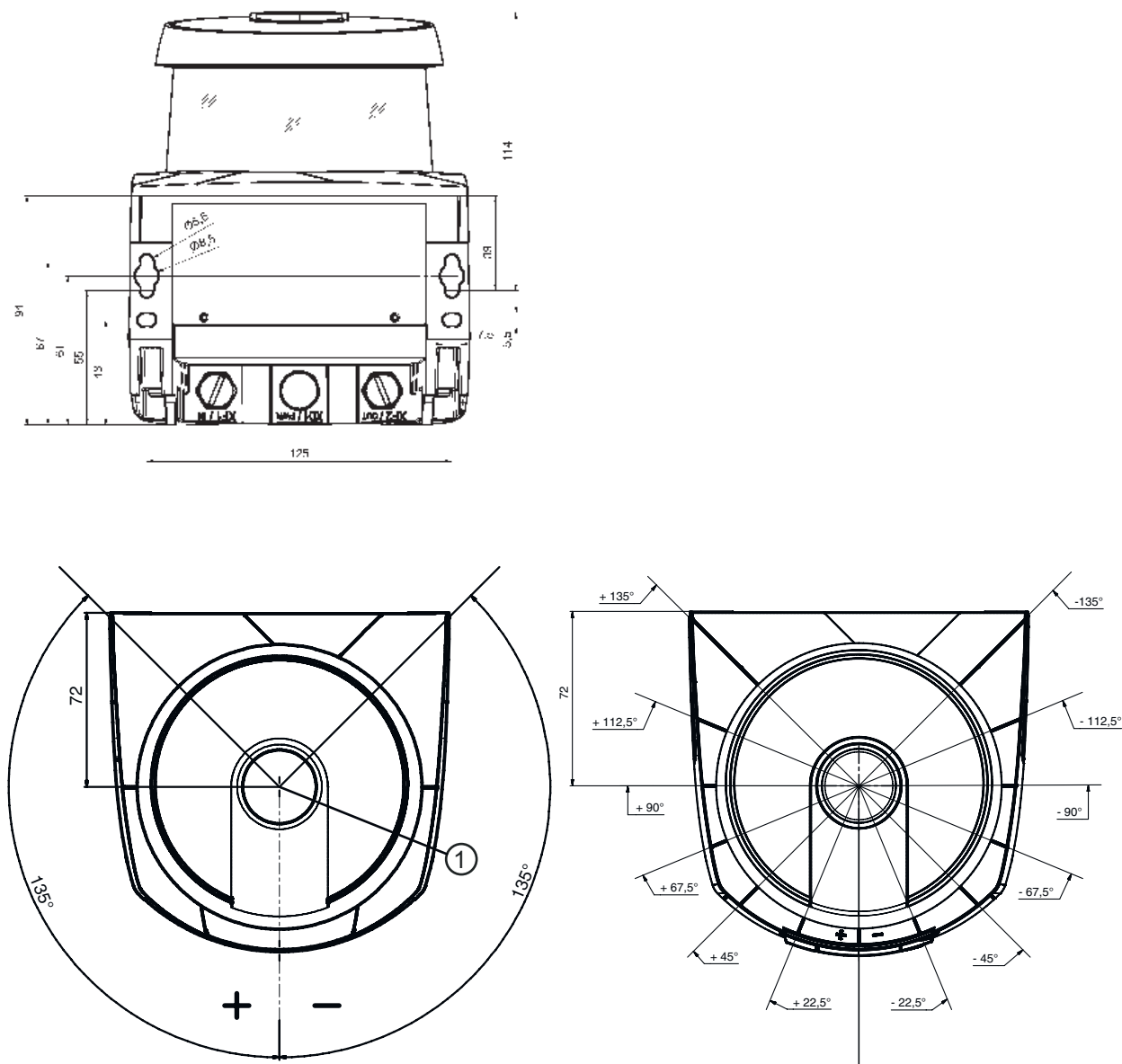

1 Reference point for distance measurement and protective field radius

Electrical connection

Connection 1

XD1

Function	Voltage supply
Type of connection	Connector
Thread size	M12
Type	Male
Material	Metal
No. of pins	4 -pin
Encoding	A-coded
Connector housing	FE/SHIELD

Electrical connection

Pin	Pin assignment
1	+24V
2	EA1
3	0 V
4	EA2

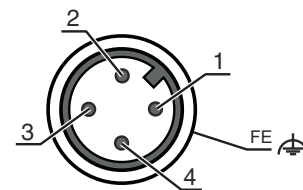

Connection 2	XF1
Function	PROFINET/PROFIsafe communication, input
Type of connection	Connector
Thread size	M12
Type	Female
Material	Metal
No. of pins	4 -pin
Encoding	D-coded
Connector housing	FE/SHIELD

Pin	Pin assignment
1	TD+
2	RD+
3	TD-
4	RD-

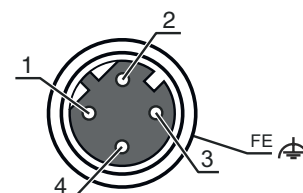

Connection 3	XF2
Function	PROFINET/PROFIsafe communication, output
Type of connection	Connector
Thread size	M12
Type	Female
Material	Metal
No. of pins	4 -pin
Encoding	D-coded
Connector housing	FE/SHIELD

Pin	Pin assignment
1	TD+
2	RD+
3	TD-
4	RD-

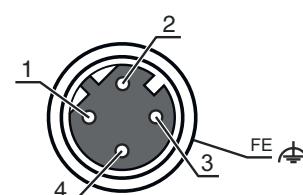

Operation and display

LED	Display	Meaning
1 -	Off	Device switched off
	Red, continuous light	OSSD off
	Red, flashing	Error
	Green, continuous light	OSSD on
2 -	Off	RES deactivated or RES activated and released
	Yellow, flashing	Protective field occupied
	Yellow, continuous light	RES activated and blocked but ready to be unlocked - protective field free and linked sensor is enabled if applicable
3 -	Off	Free warning field
	Blue, continuous light	Warning field interrupted
4 -	Off	Four field mode: warning field 3 free

Operation and display

LED	Display	Meaning
4 -	Blue, continuous light	Four field mode: warning field 3 interrupted
5 -	Yellow, flashing	Four field mode: warning field 2 interrupted
6 -	Off	No function
7 PWR	Off	Device switched off
	Red, continuous light	Error during self test or internal communication problems
	Green, flashing	PROFINET wave function active
	Green, continuous light	Device switched on, supply voltage applied, no internal error
8 PS	Off	PROFIsafe communication not initialized or switched off
	Green, flashing	Device in passive state or PROFINET wave function active
	Green, continuous light	Device on PROFIsafe active
	Red, flashing	PROFIsafe configuration failed
	Red, continuous light	PROFIsafe communication error
9 NET	Off	PROFINET communication not initialized or inactive
	Green, flashing	PROFINET bus initialization or PROFINET wave function active
	Green, continuous light	PROFINET active, data exchange with IO controller active
	Orange, flashing	Ethernet topology error
	Red, flashing	Ethernet configuration failed, no data exchange or exchange of invalid data
10 LNK/ACT1	Red, continuous light	Bus error, no communication
	Off	No Ethernet link present
	Green, continuous light	Ethernet link active, no current data transmission
	Green/orange, flashing	Ethernet link active, current data transmission
11 LNK/ACT2	Off	No Ethernet link present
	Green, continuous light	Ethernet link active, no current data transmission
	Green/orange, flashing	Ethernet link active, current data transmission

Notes

Observe intended use!

The product may only be put into operation by competent persons.
 Only use the product in accordance with its intended use.

WARNING! INVISIBLE LASER RADIATION – CLASS 1 LASER PRODUCT

The device satisfies the requirements of IEC 60825-1:2014 (EN 60825-1:2014) safety regulations for a product of **laser class 1 as well as the U.S. 21 CFR 1040.10 regulations with deviations corresponding to "Laser Notice No. 56" from May 8, 2019.**

Observe the applicable statutory and local laser protection regulations.
 The device must not be tampered with and must not be changed in any way. There are no user-serviceable parts inside the device. Repairs must only be performed by Leuze electronic GmbH + Co. KG.

Accessories

Connection technology - Connection cables

	Part no.	Designation	Article	Description
	50133860	KD S-M12-5A-P1-050	Connection cable	Connection 1: Connector, M12, Axial, Female, A-coded, 5 -pin Connection 2: Open end Shielded: Yes Cable length: 5,000 mm Sheathing material: PUR

Connection technology - Interconnection cables

	Part no.	Designation	Article	Description
	50135081	KSS ET-M12-4A-RJ45-A-P7-050	Interconnection cable	Suitable for interface: Ethernet Connection 1: Connector, M12, Axial, Male, D-coded, 4 -pin Connection 2: RJ45 Shielded: Yes Cable length: 5,000 mm Sheathing material: PUR
	50135082	KSS ET-M12-4A-RJ45-A-P7-100	Interconnection cable	Suitable for interface: Ethernet Connection 1: Connector, M12, Axial, Male, D-coded, 4 -pin Connection 2: RJ45 Shielded: Yes Cable length: 10,000 mm Sheathing material: PUR
	50135083	KSS ET-M12-4A-RJ45-A-P7-150	Interconnection cable	Suitable for interface: Ethernet Connection 1: Connector, M12, Axial, Male, D-coded, 4 -pin Connection 2: RJ45 Shielded: Yes Cable length: 15,000 mm Sheathing material: PUR

Mounting technology - Mounting brackets

	Part no.	Designation	Article	Description
	53800134	BT840M	Mounting bracket	Application: Mounting on chamfered 90° corner Dimensions: 84.9 mm x 72 mm x 205.2 mm Color: Yellow, RAL 1021 Type of fastening, at system: Through-hole mounting Type of fastening, at device: Screw type Material: Metal
	53800132	BTF815M	Mounting bracket	Application: Mounting bracket for floor mounting Dimensions: 186 mm x 120 mm x 288 mm Scan level height: 150 mm Color: Yellow, RAL 1021 Type of fastening, at system: Through-hole mounting Type of fastening, at device: Screw type Material: Metal
	53800133	BTF830M	Mounting bracket	Application: Mounting bracket for floor mounting Dimensions: 186 mm x 275 mm x 288 mm Scan level height: 300 mm Color: Yellow, RAL 1021 Type of fastening, at system: Through-hole mounting Type of fastening, at device: Screw type Material: Metal

Accessories



Mounting

	Part no.	Designation	Article	Description
	53800131	BTP800M	Loop guard	Dimensions: 160 mm x 169 mm Color: Black Material: Metal

General

	Part no.	Designation	Article	Description
	430400	RS4-clean-Set1	Cleaning set	Number of cleaning cloths: 40 Piece(s) Content of cleaning fluid: 150 ml

Services

	Part no.	Designation	Article	Description
	S981051	CS40-I-141	Safety inspection "Safety laser scanners"	Details: Checking of a safety laser scanner application in accordance with current standards and guidelines. Inclusion of the device and machine data in a database, production of a test log per application. Conditions: It must be possible to stop the machine, support provided by customer's employees and access to the machine for Leuze employees must be ensured. Restrictions: Travel costs and accommodation expenses charged separately and according to expenditure.
	S981047	CS40-S-141	Start-up support	Details: For safety devices including stopping time measurement and initial inspection. Conditions: Devices and connection cables are already mounted, price not including travel costs and, if applicable, accommodation expenses. Restrictions: Max. 3 h., no mechanical (mounting) and electrical (wiring) work performed, no changes (attachments, wiring, programming) to third-party components in the nearby environment.

Note



A list with all available accessories can be found on the Leuze website in the Download tab of the article detailed page.