

**KRTM 3B**

**Multicolor contrast scanner**

en 08-2016/11 50110625-05



**Dimensioned drawing**

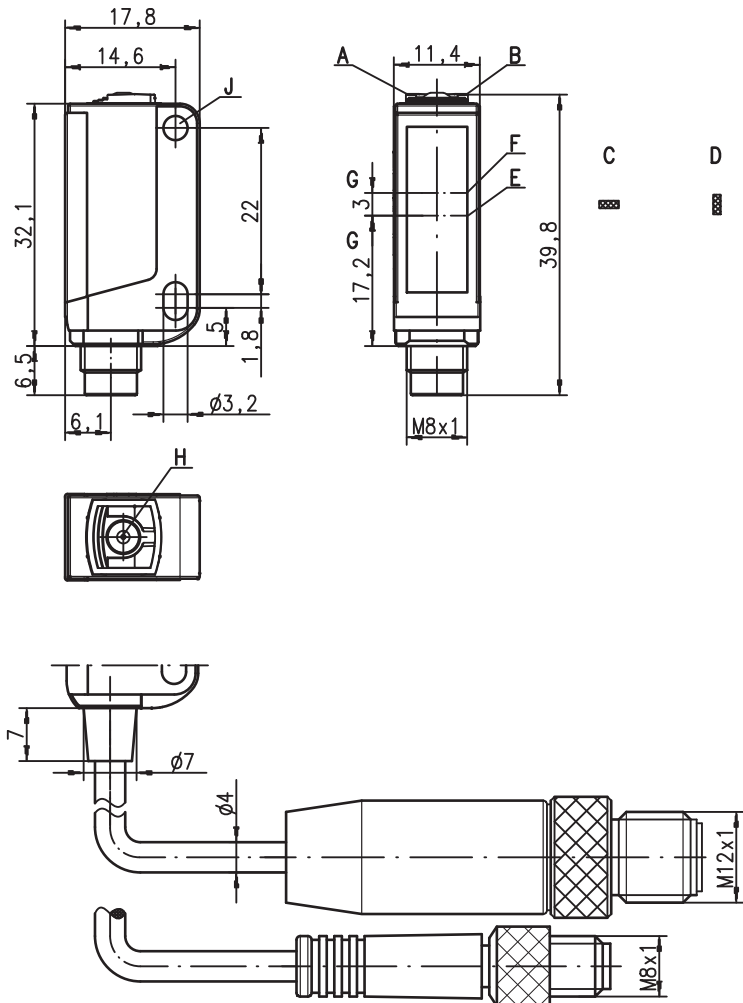

- A Green indicator diode
- B Yellow indicator diode
- C Light spot orientation horizontal
- D Light spot orientation vertical
- E Transmitter
- F Receiver
- G Optical axis
- H Teach button
- J Mounting sleeve

**Electrical connection**

**Connector, 4-pin**

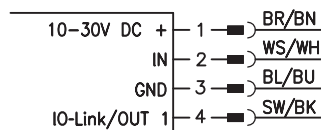

**KRTM 3B/L6.1121-S8**

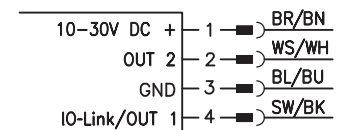

**14.5mm**



- RGB transmitter
- Various teach variants
- Short response time
- Switching threshold adjustment via EasyTune
- Level adaptation for glossy objects
- Keyboard lockout
- Remote teach via cable
- 20ms pulse stretching

We reserve the right to make changes • DS\_KRTM3B\_en\_50110625\_05.fm



**Accessories:**

(available separately)

- Mounting systems (BT 3...)
- Cable with M8 or M12 connector (K-D ...)

**Specifications**

**Optical data**

Scanning range <sup>1)</sup>		14.5mm ± 2mm
Light spot dimensions	in RUN-Mode in Teach-Mode	1.5mm x 4mm (at a distance of 14.5mm) 1.5mm x 6.5mm (at a distance of 14.5mm)
Light spot orientation		vertical or horizontal (see dimensioned drawing)
Light source <sup>2)</sup>		LEDs (red, green, blue)
Wavelength		640nm, 525nm, 470nm

**Sensor operating modes**

IO-Link	COM2 (38.4kBAud)
SIO	standard push-pull

**Timing of the sensor**

Internal switching frequency	10kHz
Internal response time	50µs
Response jitter, internal	20µs
Repeatability <sup>3)</sup>	0.02mm
Delay before start-up	≤ 300ms
Conveyor speed during teach	≤ 0.1 m/s for a mark width of 1mm
Teach process	static 1-point, static 2-point or dynamic 2-point
Teach delay	≤ 10ms

**Timing of the outputs**

Response time	SIO operation (without IO-Link): 50µs COM2 (with IO-Link): typ. 2.5ms
---------------	--------------------------------------------------------------------------

**Electrical data**

Operating voltage U <sub>B</sub> <sup>4)</sup>	with SIO with COM2	10 ... 30VDC (incl. residual ripple) 18 ... 30VDC (incl. residual ripple)
Residual ripple		≤ 15% of U <sub>B</sub>
Output/function	.../2... .../4... .../6.0001... .../6.1121... .../L6.1121...	pin 4: NPN transistor, GND if mark detected pin 4: PNP transistor, U <sub>B</sub> if mark detected pin 4: push-pull switching output, PNP: U <sub>B</sub> if mark detected, NPN: GND if mark detected pin 4: IO-Link 1.0 pin 4: IO-Link 1.1
Signal voltage high/low		≥ (U <sub>B</sub> -2V) ≤ 2V
Output current		max. 100mA
Open-circuit current		≤ 25mA

**Indicators**

Green LED in continuous light	ready
Green and yellow LED flashing at 3Hz	teach event active
Green and yellow LED flashing at 8Hz	teaching error
Green LED off and yellow LED flashing at 8Hz	sensor error
Yellow LED in continuous light	mark detected (dependent on the teach sequence)
Transmitter LEDs flashing at 8Hz	teaching error

**Mechanical data**

Housing	plastic (PC-ABS), with nickel-plated mounting sleeve
Optics cover	plastic (PMMA)
Weight	10g
Connection type	M8 connector, metal

**Environmental data**

Ambient temp. (operation/storage)	-30 °C ... +55 °C / -30 °C ... +70 °C
Protective circuit <sup>5)</sup>	2, 3
VDE safety class	III
Protection class	IP 67
Light source	free group (in acc. with EN 62471)
Standards applied	IEC 60947-5-2
Certifications	UL 508, C22.2 No.14-13 <sup>4) 6)</sup>

**Options**

**Input pin 2 (not for KRTM 3B/L6...)**

Function characteristics	keyboard lockout / line teach / pulse stretching
Input active/not active	≥ 8V/≤ 2V or not connected

**Output pin 4**

Line teach active	for SIO for COM2	2Hz at the switching output see configuration file IO DD
Error after line teach	for SIO for COM2	2Hz at the switching output see configuration file IO DD

- 1) Scanning range: recommended range with performance reserve
- 2) Average life expectancy 100,000h at an ambient temperature of 25 °C
- 3) At conveyor speed 1 m/s
- 4) For UL applications: for use in class 2 circuits according to NEC only
- 5) 2=polarity reversal protection, 3=short-circuit protection for all transistor outputs
- 6) These proximity switches shall be used with UL Listed Cable assemblies rated 30V, 0.5A min, in the field installation, or equivalent (categories: CYJV/CYJV7 or PVVA/PVVA7)

**Remarks**

**UL REQUIREMENTS**

Enclosure Type Rating: Type 1  
**For Use in NFPA 79 Applications only.**  
Adapters providing field wiring means are available from the manufacturer. Refer to manufacturers information.  
**CAUTION** – the use of controls or adjustments or performance of procedures other than those specified herein may result in hazardous radiation exposure.  
**ATTENTION !** Si d'autres dispositifs d'alignement que ceux préconisés ici sont utilisés ou s'il est procédé autrement qu'indiqué, cela peut entraîner une exposition à des rayonnements et un danger pour les personnes.

**Operate in accordance with intended use!**

- ⚠ This product is not a safety sensor and is not intended as personnel protection.
- ⚠ The product may only be put into operation by competent persons.
- ⚠ Only use the product in accordance with the intended use.

- With glossy objects, the sensor is to be fastened at an inclination of approx. 10° relative to the object surface.

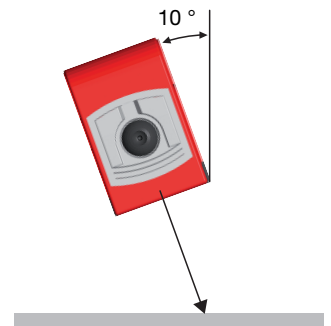

# KRTM 3B

# Multicolor contrast scanner

## Order guide

Selection table		Order code →											
Equipment ↓		KRTM 3B/6.1121-S8 Part No. 50111312	KRTM 3B/4.1121-S8 Part No. 50110584	KRTM 3B/4.1221-S8 Part No. 50110588	KRTM 3B/2.1121-S8 Part No. 50110585	KRTM 3B/4.1121.200-S12 Part No. 50110586	KRTM 3B/2.1121.200-S12 Part No. 50110587	KRTM 3B/2.1221-S8 Part No. 50110589	KRTM 3B/4.1221.200-S12 Part No. 50110590	KRTM 3B/2.1221.200-S12 Part No. 50110591	KRTM 3B/6.0001-S8 Part No. 50116788	KRTM 3B/L6.1121-S8 Part No. 50135163	
Transmitter color	white light												
	RGB (red, green, blue)	•	•	•	•	•	•	•	•	•	•	•	
	laser red light												
Light spot orientation	vertical	•	•	•	•	•	•	•	•	•	•	•	
	horizontal												
	round												
Output (OUT 1)	PNP transistor output		•	•		•			•				
	NPN transistor output				•		•	•		•			
	push-pull switching output	•									•	•	
	IO-Link 1.0	•											
	IO-Link 1.1											•	
Input (IN)	teach input	•	•	•	•	•	•	•	•	•	•	•	
Housing	standard	•	•	•	•	•	•	•	•	•	•	•	
	economy												
Connection	M8 connector, metal	•	•	•	•			•			•	•	
	M8 connector, plastic												
	200mm cable with M12 connector					•	•		•	•			
Teach process	static 1-point												
	static 2-point	•	•		•	•	•				•	•	
	dynamic 2-point			•				•	•	•			
Response time / Switching frequency	50µs / 10kHz	•	•	•	•	•	•	•	•	•	•	•	
	83µs / 6kHz												
	125µs / 4kHz												
Configuration	switching threshold adjustment with EasyTune via teach button	•	•	•	•	•	•	•	•	•	•	•	
	remote teach, keyboard lockout and pulse stretching via pin 2	•	•	•	•	•	•	•	•	•	•	•	
	teach level 1, teach-level 2 and pulse stretching via teach button	•	•	•	•	•	•	•	•	•	•	•	
	dual channel architecture											•	

## IO-Link process data

The sensor transmits 2 bytes to the master.

Data bit																Assignment	Default settings
15	14	13	12	11	10	9	8	7	6	5	4	3	2	1	0		
																Switching output	0 = no mark, 1 = mark detected
																Not assigned	Free
																Sensor operation	0 = off, 1 = on
																Switching threshold LSB	Value range 0 ... 31 (0 ... 100% in approx. 3% steps)  0% = min. switching threshold 100% = max. switching threshold
																Switching threshold	
																Switching threshold	
																Switching threshold MSB	
																Active transmitter LSB	00 = red, 01 = green or white,
																Active transmitter MSB	10 = blue, 11 = all colors on (teach-in active)
																Not assigned	Free
																Measurement value LSB	Value range 0 ... 31 (0 ... 100% in approx. 3% steps)  0% = min. signal level 100% = max. signal level
																Measurement value	
																Measurement value	
																Measurement value MSB	



Further information and details on the IO-Link interface can be found in the separate IO-Link data sheet.

## Static 2-point teach

Suitable for manual positioning of the marks (availability dependent on sensor type).

### Switching threshold in center:

Position the background. 	Press teach button for 2 ... 7s and release.  2 ... 7s Value for background is accepted.	LEDs flash simultaneously. 	Position the mark. 	Briefly press teach button.  Value for mark is accepted.	Sensor in RUN mode. Yellow LED illuminates.  Switching threshold set in the center.
------------------------------	---------------------------------------------------------------------------------------------------	--------------------------------	------------------------	----------------------------------------------------------------	-------------------------------------------------------------------------------------------

### Switching threshold near the mark:

Position the background. 	Press teach button for 7 ... 12s and release.  7 ... 12s Value for background is accepted.	LEDs flash alternately. 	Position the mark. 	Briefly press teach button.  Value for mark is accepted.	Sensor in RUN mode. Yellow LED illuminates.  Switching threshold is set near the mark.
------------------------------	-----------------------------------------------------------------------------------------------------	-----------------------------	------------------------	----------------------------------------------------------------	----------------------------------------------------------------------------------------------





**KRTM 3B**

**Multicolor contrast scanner**



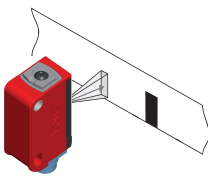
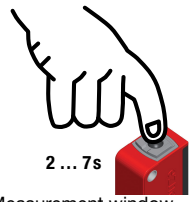

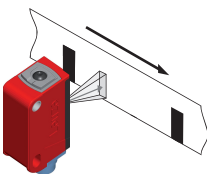
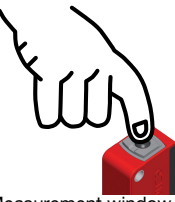
**Dynamic 2-point teach**

Suitable for marks moved during automated machine processes (availability dependent on sensor type).

**Switching threshold in center**

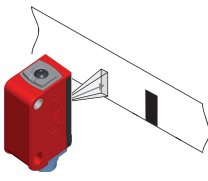
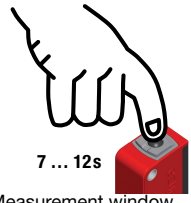
<p>Position the background.</p> 	<p>Press teach button for 2 ... 7s and release.</p> <p>2 ... 7s</p>  <p>Measurement window opens.</p>	<p>LEDs flash simultaneously.</p>  <p><b>Simultaneous flashing</b></p>	<p>Allow marks to pass through dynamically.</p> 	<p>Briefly press teach button.</p>  <p>Measurement window closes.</p>	<p>Sensor in RUN mode. Yellow LED is off.</p>  <p>Switching threshold set in the center.</p>
-------------------------------------------------------------------------------------------------------------------	----------------------------------------------------------------------------------------------------------------------------------------------------------------------------------------	---------------------------------------------------------------------------------------------------------------------------------------------------------	-----------------------------------------------------------------------------------------------------------------------------------	----------------------------------------------------------------------------------------------------------------------------------------------------------	---------------------------------------------------------------------------------------------------------------------------------------------------------------------------------

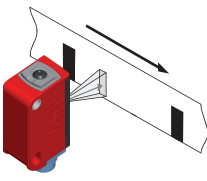
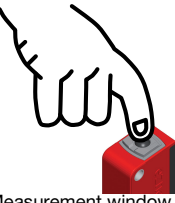



**Switching threshold near the mark**

<p>Position the background.</p> 	<p>Press teach button for 7 ... 12s and release.</p> <p>7 ... 12s</p>  <p>Measurement window opens.</p>	<p>LEDs flash alternatingly.</p>  <p><b>Alternating flashing</b></p>	<p>Allow marks to pass through dynamically.</p> 	<p>Briefly press teach button.</p>  <p>Measurement window closes.</p>	<p>Sensor in RUN mode. Yellow LED is off.</p>  <p>Switching threshold is set near the mark.</p>
-------------------------------------------------------------------------------------------------------------------	------------------------------------------------------------------------------------------------------------------------------------------------------------------------------------------	-------------------------------------------------------------------------------------------------------------------------------------------------------	-----------------------------------------------------------------------------------------------------------------------------------	----------------------------------------------------------------------------------------------------------------------------------------------------------	------------------------------------------------------------------------------------------------------------------------------------------------------------------------------------



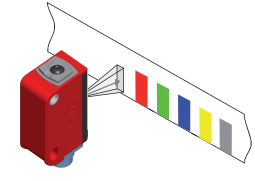
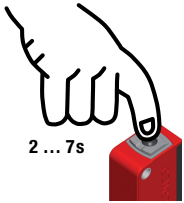

**Static 1-point teach**

Suitable for detecting all marks outside of the reference value (dependent on available sensor type).

**Standard sensitivity**

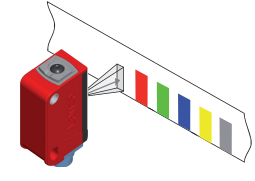
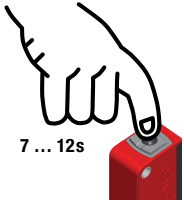
<p>Position reference value.</p> 	<p>Press the teach button for 2 ...7s.</p> <p>2 ... 7s</p> 	<p>LEDs flash simultaneously.</p>  <p><b>Simultaneous flashing</b></p>	<p>Release teach button.</p>  <p>Value is accepted.</p>	<p>Sensor in RUN mode. Yellow LED is off.</p>  <p>Standard sensitivity is set.</p>
----------------------------------------------------------------------------------------------------------------------	------------------------------------------------------------------------------------------------------------------------------------------------	-----------------------------------------------------------------------------------------------------------------------------------------------------------	---------------------------------------------------------------------------------------------------------------------------------------------	-------------------------------------------------------------------------------------------------------------------------------------------------------------------------

**High sensitivity**

<p>Position reference value.</p> 	<p>Press the teach button for 7 ...12s.</p> <p>7 ... 12s</p> 	<p>LEDs flash alternatingly.</p>  <p><b>Alternating flashing</b></p>	<p>Release teach button.</p>  <p>Value is accepted.</p>	<p>Sensor in RUN mode. Yellow LED is off.</p>  <p>High sensitivity is set.</p>
----------------------------------------------------------------------------------------------------------------------	--------------------------------------------------------------------------------------------------------------------------------------------------	---------------------------------------------------------------------------------------------------------------------------------------------------------	---------------------------------------------------------------------------------------------------------------------------------------------	---------------------------------------------------------------------------------------------------------------------------------------------------------------------

## Switching threshold diagrams

### Static 2-point teach

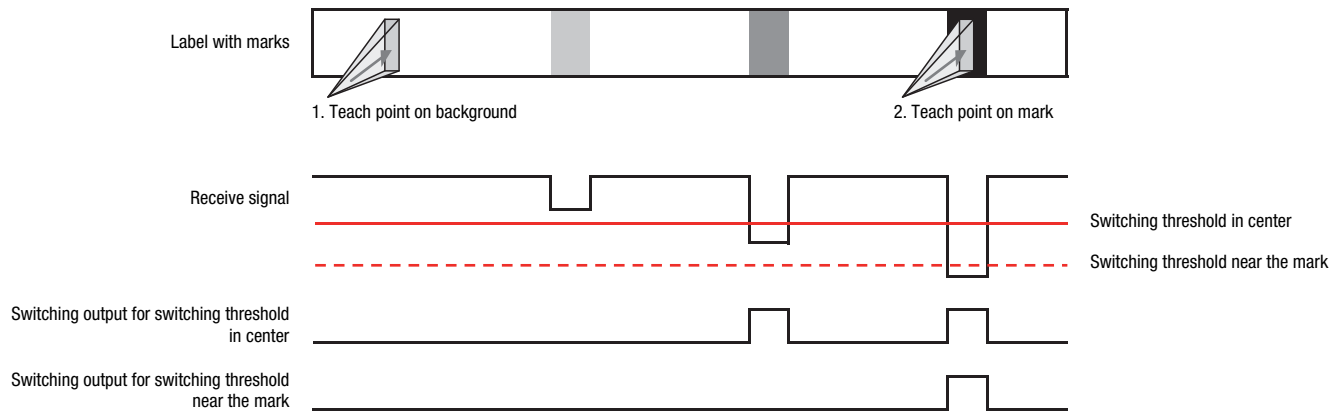

### Dynamic 2-point teach

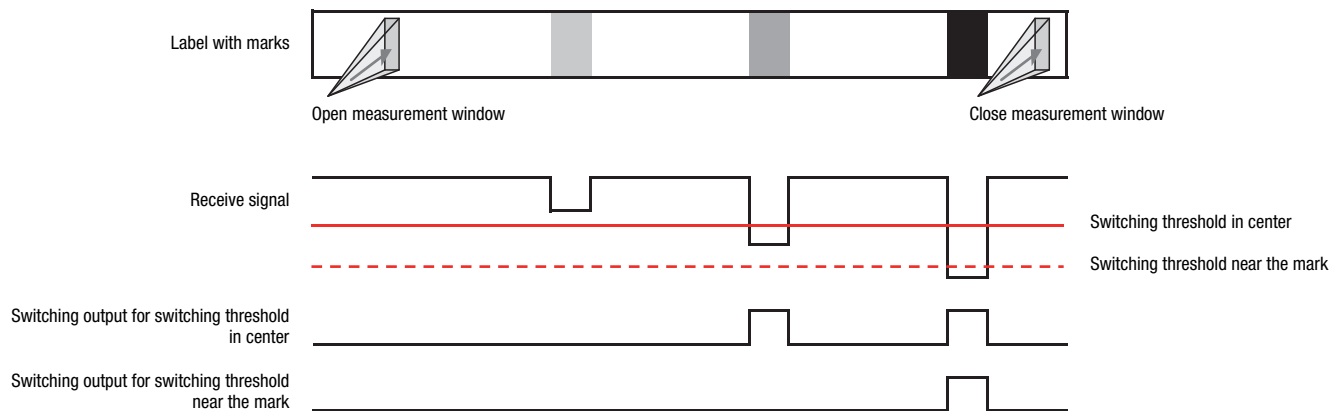

### Static 1-point teach

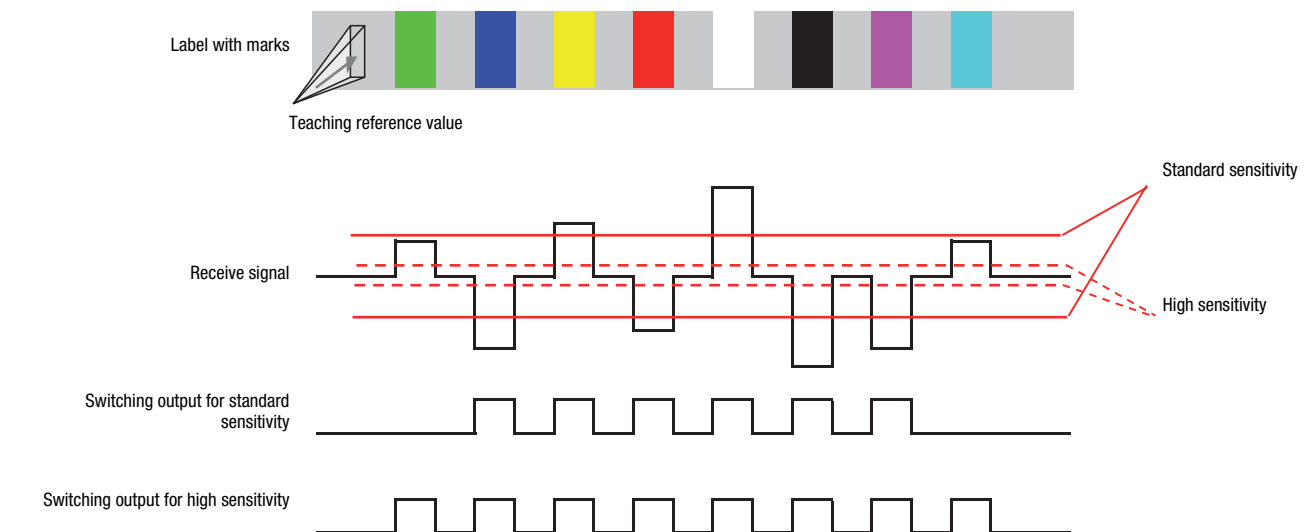

**KRTM 3B**

**Multicolor contrast scanner**

**Pulse stretching option**

Switching pulse stretching on or off:

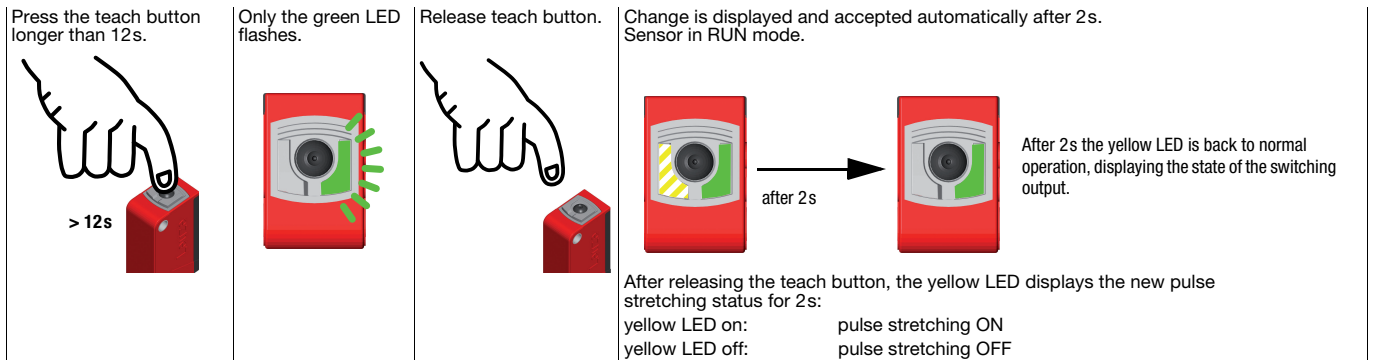

**"EasyTune" option - fine tuning of the switching threshold**

Following power-on and completed teach event:

Green LED illuminates continuously (ready)

Yellow LED on/off continuously (mark detected/not detected)

**Increasing the switching threshold:**

Long press of the button = large force expenditure = increase switching threshold  
 Each press of the button with a duration between 200ms and 2s increments the switching threshold.

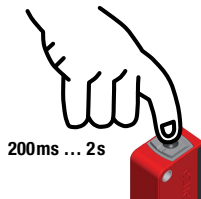

A press of the button is acknowledged by a single, brief flash of the green LED – the new switching threshold is now valid.

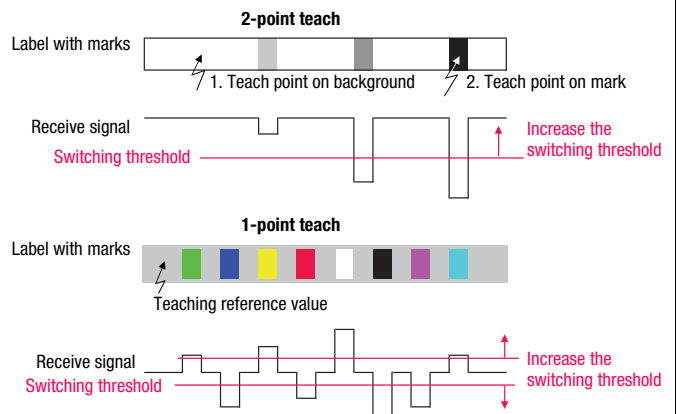

**Reducing the switching threshold:**

Short press of the button = small force expenditure = reduce switching threshold  
 Each press of the button with a duration between 2ms and 200ms decrements the switching threshold.

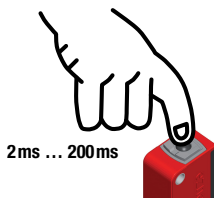

A press of the button is acknowledged by a single, brief flash of the green LED – the new switching threshold is now valid.

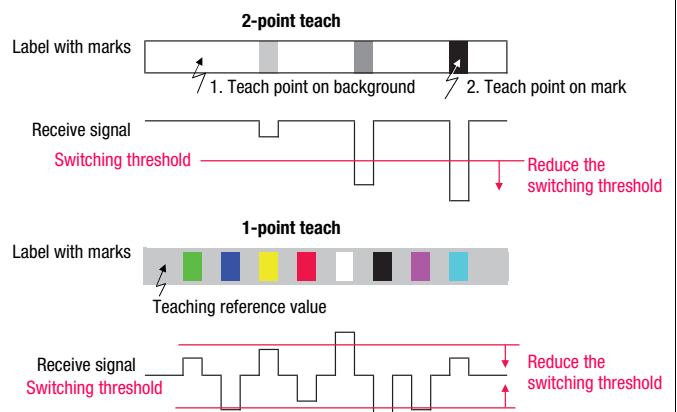

If the upper or lower end of the adjustment range is reached, the green and yellow LEDs flash at a considerably higher frequency of 8Hz for the duration of one second.

### Sensor adjustments via the input IN (Pin 2, not for KRTM 3B/L6...)



The following description applies to PNP switching logic!

Signal level LOW  $\leq 2V$

Signal level HIGH  $\geq (U_B - 2V)$

With the NPN models, the signal levels are inverted!

#### Switching threshold in center / standard sensitivity

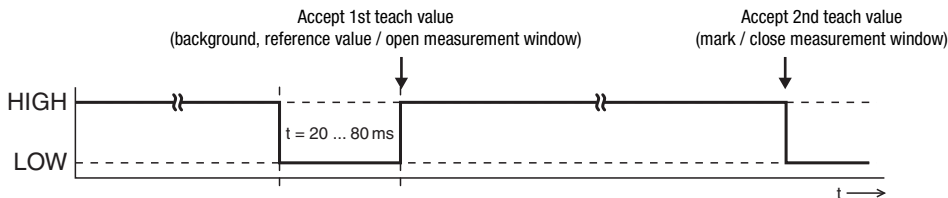

#### Switching threshold near the mark / high sensitivity

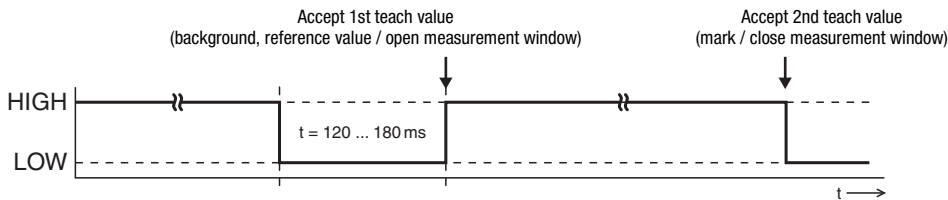

#### Pulse stretching ON

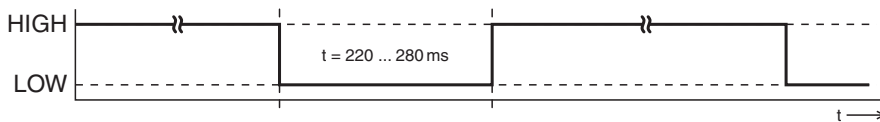

#### Pulse stretching OFF

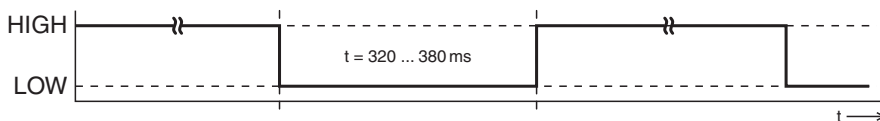

### Locking the teach button via the input IN (Pin 2, not for KRTM 3B/L6...)



A static HIGH signal ( $\geq 20ms$ ) at the teach input locks the teach button on the sensor if required, such that no manual operation is possible (e.g., protection from erroneous operation or manipulation).

If the teach input is not connected or if there is a static low signal, the button is unlocked and can be operated freely.

