

Technical data sheet Safety light curtain receiver

Part no.: 68092919

MLC320R90-1950



Figure can vary

Contents

- Technical data
- Dimensioned drawings
- Electrical connection
- Circuit diagrams
- Operation and display
- Suitable transmitters
- Part number code
- Notes
- Accessories

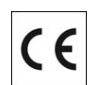

Technical data

Basic data

Series	MLC 300
Device type	Receiver
Contains	2x BT-NC sliding block
Application	Access guarding Danger zone guarding

Functions

Function package	Standard
Functions	Contactormonitoring (EDM) Start/restart interlock (RES) Transmission channel changeover

Characteristic parameters

Type	2, IEC/EN 61496
SIL	1, IEC 61508
SILCL	1, IEC/EN 62061
Performance Level (PL)	c, EN ISO 13849-1
PFH _D	5.06E-08 per hour
Mission time T _M	20 years, EN ISO 13849-1
Category	2, EN ISO 13849

Protective field data

Resolution	90 mm
Protective field height	1,950 mm

Optical data

Synchronization	Optical between transmitter and receiver
-----------------	--

Electrical data

Protective circuit	Overvoltage protection Short circuit protected
--------------------	---

Performance data

Supply voltage U _B	24 V, DC, -20 ... 20 %
Current consumption, max.	150 mA
Fuse	2 A semi time-lag

Inputs

Number of digital switching inputs	3 Piece(s)
------------------------------------	------------

Switching inputs

Type	Digital switching input
Switching voltage high, min.	18 V
Switching voltage low, max.	2.5 V
Switching voltage, typ.	22.5 V
Voltage type	DC

Outputs

Number of safety-related switching outputs (OSSDs)	2 Piece(s)
--	------------

Safety-related switching outputs

Type	Safety-related switching output OSSD
Switching voltage high, min.	18 V
Switching voltage low, max.	2.5 V
Switching voltage, typ.	22.5 V
Voltage type	DC
Current load, max.	380 mA
Load inductivity	2,000 µH
Load capacity	0.3 µF
Residual current, max.	0.2 mA
Residual current, typ.	0.002 mA
Voltage drop	1.5 V

Safety-related switching output 1

Assignment	Connection 1, pin 5
Switching element	Transistor, PNP

Safety-related switching output 2

Assignment	Connection 1, pin 6
Switching element	Transistor, PNP

Timing

Response time	7 ms
Restart delay time	100 ms

Connection

Number of connections	1 Piece(s)
-----------------------	------------

Connection 1

Function	Machine interface
Type of connection	Connector
Thread size	M12
Material	Metal
No. of pins	8 -pin

Cable properties

Permissible conductor cross section, typ.	0.25 mm ²
Length of connection cable, max.	100 m
Permissible cable resistance to load, max.	200 Ω

Mechanical data

Dimension (W x H x L)	29 mm x 2,016 mm x 35.4 mm
Housing material	Metal
Metal housing	Aluminum
Lens cover material	Plastic / PMMA
Material of end caps	Diecast zinc
Net weight	2,100 g
Housing color	Yellow, RAL 1021
Type of fastening	Groove mounting Mounting bracket Mounting on Device Column Swivel mount

Operation and display

Type of display	7-segment display LED
Number of LEDs	2 Piece(s)

Technical data

Environmental data

Ambient temperature, operation	0 ... 55 °C
Ambient temperature, storage	-30 ... 70 °C
Relative humidity (non-condensing)	0 ... 95 %

Certifications

Degree of protection	IP 65
Protection class	III
Certifications	c CSA US c TÜV NRTL US TÜV Süd
Vibration resistance	50 m/s ²
Shock resistance	100 m/s ²
US patents	US 6,418,546 B

Classification

Customs tariff number	85365019
eCl@ss 5.1.4	27272704
eCl@ss 8.0	27272704
eCl@ss 9.0	27272704
eCl@ss 10.0	27272704
eCl@ss 11.0	27272704
ETIM 5.0	EC002549
ETIM 6.0	EC002549
ETIM 7.0	EC002549

Dimensioned drawings

All dimensions in millimeters

Calculation of the effective protective field height $H_{PFE} = H_{PFN} + B + C$

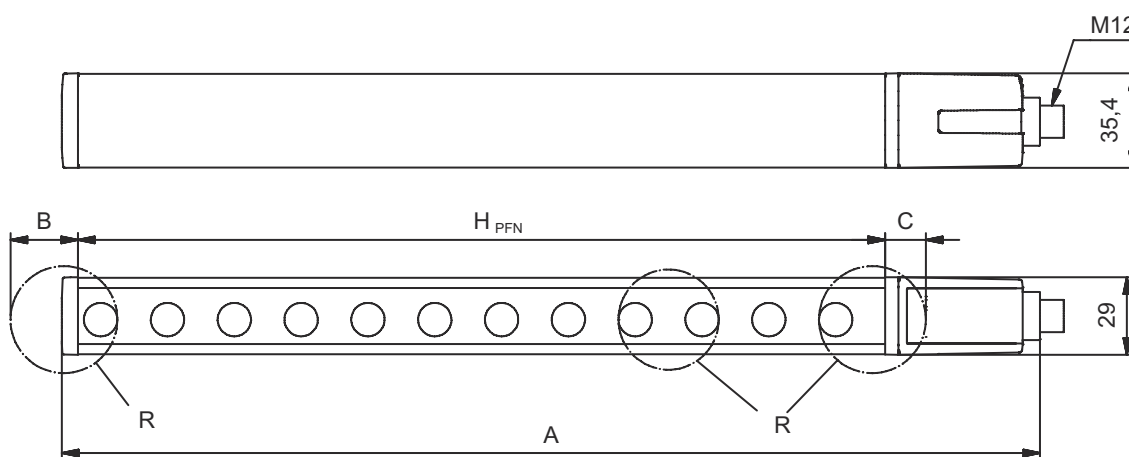

H_{PFE} Effective protective field height = 2040 mm

H_{PFN} Nominal protective field height = 1950 mm

A Total height = 2016 mm

B 50 mm

C 40 mm

R Effective protective field height H_{PFE} goes beyond the dimensions of the optics area to the outer borders of the circles labeled with R.

Electrical connection

Connection 1

Function	Machine interface
Type of connection	Connector
Thread size	M12
Type	Male
Material	Metal
No. of pins	8 -pin
Encoding	A-coded
Connector housing	FE/SHIELD

Electrical connection

Pin	Pin assignment	Conductor color
1	IO1	White
2	VIN1	Brown
3	IN3	Green
4	IN4	Yellow
5	OSSD1	Gray
6	OSSD2	Pink
7	VIN2	Blue
8	IN8	Red



Circuit diagrams

Connection diagram receiver

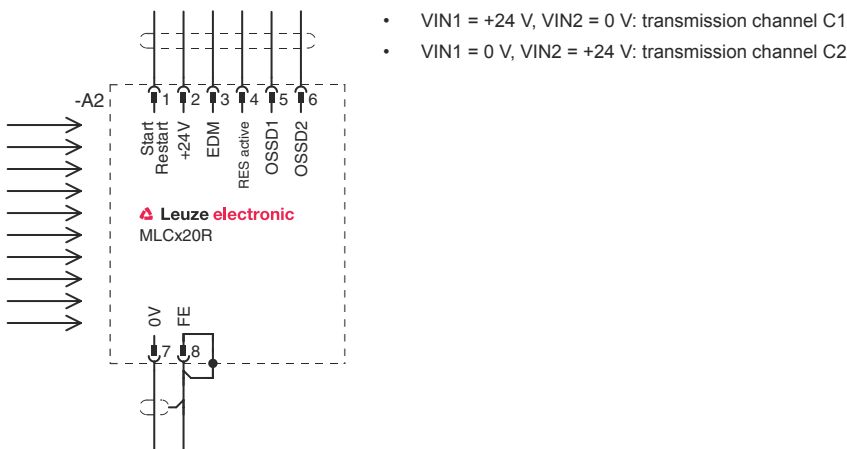

Circuit diagram example with downstream MSI-RM2 safety relay

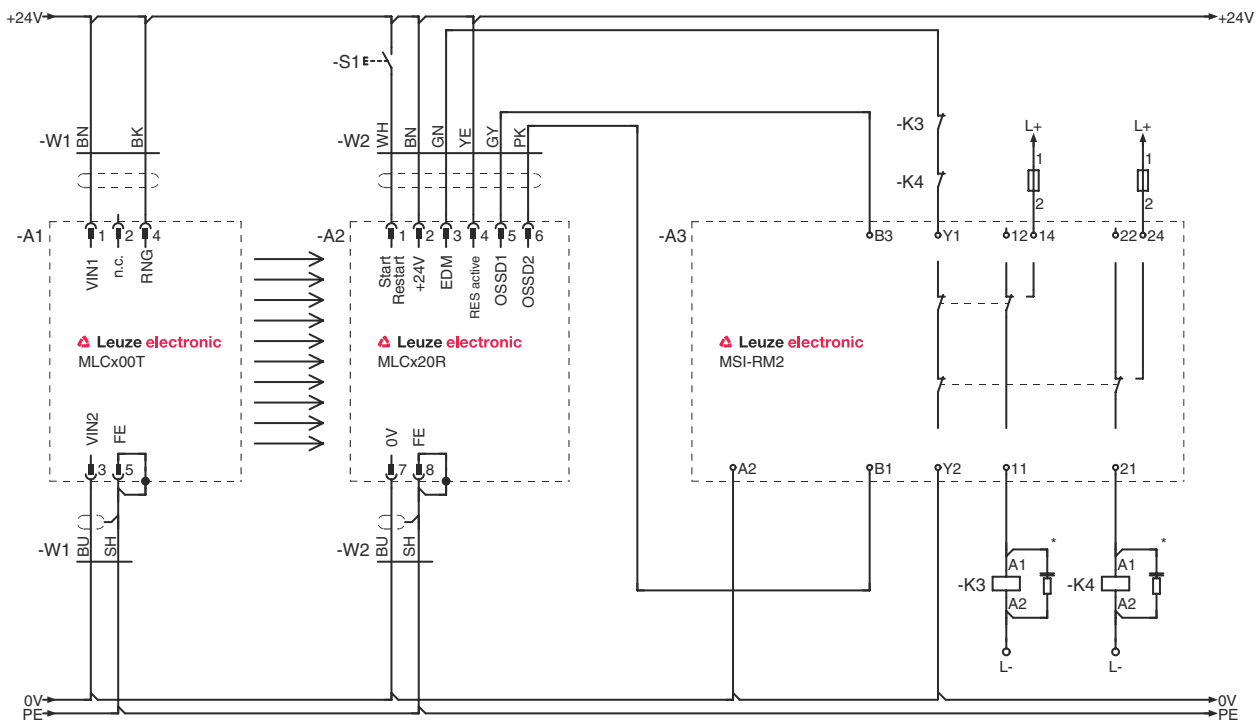

Operation and display

LED	Display	Meaning
1	Off	Device switched off
	Red, continuous light	OSSD off
	Red, flashing, 1 Hz	External error
	Red, flashing, 10 Hz	Internal error
	Green, flashing, 1 Hz	OSSD on, weak signal
	Green, continuous light	OSSD on
2	Off	RES deactivated or RES activated and enabled or RES blocked and protective field interrupted
	Yellow, continuous light	RES activated and blocked but ready to be unlocked - protective field free and linked sensor is enabled if applicable

Suitable transmitters

Part no.	Designation	Article	Description
68090919	MLC300T90-1950	Safety light curtain transmitter	Resolution: 90 mm Protective field height: 1,950 mm Operating range: 0 ... 20 m Connection: Connector, M12, Metal, 5 -pin

Part number code

Part designation: MLCxyy-za-hhhh-ei-ooo

MLC	Safety light curtain
x	Series 3: MLC 300 5: MLC 500
yy	Function classes 00: transmitter 01: transmitter (AIDA) 02: transmitter with test input 10: basic receiver - automatic restart 11: basic receiver - automatic restart (AIDA) 20: standard receiver - EDM/RES selectable 30: extended receiver - blanking/muting
z	Device type T: transmitter R: receiver
a	Resolution 14: 14 mm 20: 20 mm 30: 30 mm 40: 40 mm 90: 90 mm
hhhh	Protective field height 150 ... 3000: from 150 mm to 3000 mm
e	Host/Guest (optional) H: Host MG: Middle Guest G: Guest



Part number code

MLC **Safety light curtain**

i	Interface (optional) /A: AS-i
ooo	Option /V: high Vibration-proof EX2: explosion protection (zones 2 + 22) SPG: Smart Process Gating

Note	
	<p>↪ A list with all available device types can be found on the Leuze website at www.leuze.com.</p>

Notes

 Observe intended use!	
	<p>↪ The product may only be put into operation by competent persons.</p> <p>↪ Only use the product in accordance with its intended use.</p>

Accessories

Connection technology - Connection cables

	Part no.	Designation	Article	Description
	50135128	KD S-M12-8A-P1-050	Connection cable	Connection 1: Connector, M12, Axial, Female, A-coded, 8 -pin Connection 2: Open end Shielded: Yes Cable length: 5,000 mm Sheathing material: PUR

Mounting technology - Swivel mounts

	Part no.	Designation	Article	Description
	429393	BT-2HF	Mounting bracket set	Fastening, at system: Through-hole mounting Mounting bracket, at device: Clampable Type of mounting device: Turning, 360° Material: Metal, Plastic

Accessories

Services

	Part no.	Designation	Article	Description
	S981050	CS40-I-140	Safety inspection "Safety light barriers"	<p>Details: Checking of a safety light barrier application in accordance with current standards and guidelines. Inclusion of the device and machine data in a database, production of a test log per application.</p> <p>Conditions: It must be possible to stop the machine, support provided by customer's employees and access to the machine for Leuze employees must be ensured.</p> <p>Restrictions: Travel costs and accommodation expenses charged separately and according to expenditure.</p>
	S981046	CS40-S-140	Start-up support	<p>Details: For safety devices including stopping time measurement and initial inspection.</p> <p>Conditions: Devices and connection cables are already mounted, price not including travel costs and, if applicable, accommodation expenses.</p> <p>Restrictions: Max. 2 h., no mechanical (mounting) and electrical (wiring) work performed, no changes (attachments, wiring, programming) to third-party components in the nearby environment.</p>

Note



A list with all available accessories can be found on the Leuze website in the Download tab of the article detailed page.