

Technical data sheet

Inductive switch

Part no.: 50129371

IS 230MM/2NC-15N

Contents

- Technical data
- Dimensioned drawings
- Electrical connection
- Diagrams
- Operation and display
- Part number code
- Notes
- Accessories



Figure can vary



Technical data

Basic data

Series	230
Typ. operating range limit S_n	15 mm
Operating range S_a	0 ... 12.1 mm

Characteristic parameters

MTTF	930 years
------	-----------

Electrical data

Protective circuit	Inductive protection
	Polarity reversal protection
	Short circuit protected

Performance data

Supply voltage U_B	10 ... 30 V, DC
Residual ripple	0 ... 20 %, From U_B
Open-circuit current	0 ... 10 mA
Temperature drift, max. (in % of S_r)	10 %, Over the entire operating temperature range
Repeatability, max. (in % of S_r)	5 %, For $U_B = 20 \dots 30$ VDC, ambient temperature $T_a = 23^\circ\text{C} \pm 5^\circ\text{C}$
Switching hysteresis	20 %

Outputs

Number of digital switching outputs	1 Piece(s)
-------------------------------------	------------

Switching outputs

Voltage type	DC
Switching current, max.	200 mA
Residual current, max.	0.1 mA
Voltage drop	≤ 2 V

Switching output 1

Switching element	Transistor, NPN
Switching principle	NC (normally closed)

Timing

Switching frequency	700 Hz
Readiness delay	60 ms

Connection

Number of connections	1 Piece(s)
-----------------------	------------

Connection 1

Function	Signal OUT
	Voltage supply
Type of connection	Cable
Cable length	2,000 mm
Sheathing material	PVC
Cable color	Gray
Number of conductors	3 -wire
Wire cross section	0.34 mm ²

Mechanical data

Design	Cylindrical
Thread size	M30 x 1.5 mm
Dimension (\varnothing x L)	30 mm x 52 mm
Type of installation	Non-embedded
Housing material	Metal
Metal housing	Nickel-plated brass
Sensing face material	Plastic, Polybutylene (PBT)
Net weight	180 g
Housing color	Red, RAL 3000 Silver
Type of fastening	Mounting thread Via optional mounting device
Standard measuring plate	45 x 45 mm ² , Fe360

Operation and display

Type of display	LED
Number of LEDs	1 Piece(s)

Environmental data

Ambient temperature, operation	-25 ... 70 °C
Ambient temperature, storage	-25 ... 70 °C

Certifications

Degree of protection	IP 67
Protection class	II
Certifications	c UL US
Test procedure for EMC in accordance with standard	IEC 61000-4-2
	IEC 61000-4-3
	IEC 61000-4-4
Standards applied	IEC 60947-5-2

Correction factors

Aluminum	0.5
Stainless steel	0.85
Copper	0.4
Brass	0.5
Fe360 steel	1

Classification

Customs tariff number	85365019
eCl@ss 5.1.4	27270101
eCl@ss 8.0	27270101
eCl@ss 9.0	27270101
eCl@ss 10.0	27270101
eCl@ss 11.0	27270101
ETIM 5.0	EC002714
ETIM 6.0	EC002714
ETIM 7.0	EC002714

Dimensioned drawings

All dimensions in millimeters

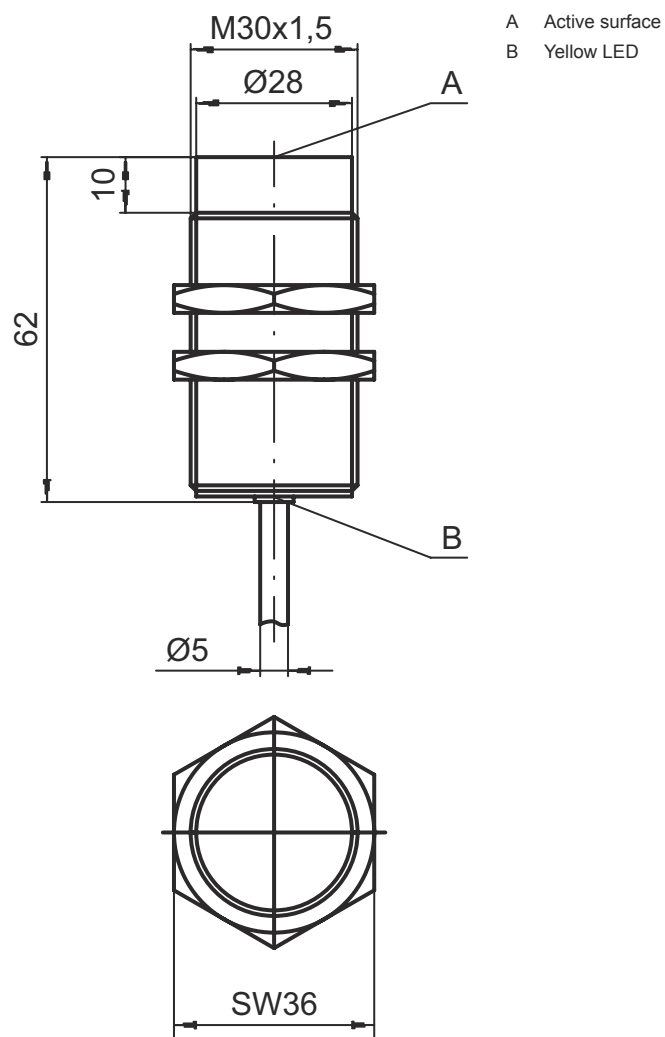

Electrical connection

Connection 1

Function	Signal OUT
	Voltage supply
Type of connection	Cable
Cable length	2,000 mm
Sheathing material	PVC
Cable color	Gray
Number of conductors	3 -wire
Wire cross section	0.34 mm ²

Conductor color

Conductor assignment

Brown	V+
Blue	GND
Black	OUT 1

Diagrams

Non-embedded installation

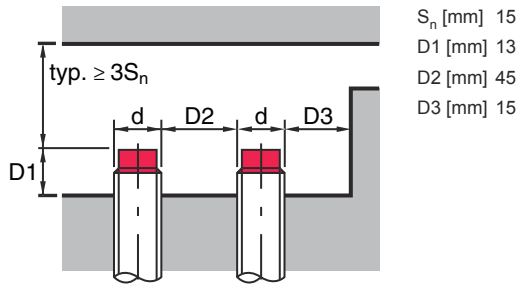

Types with $S_n = 15.0$ mm

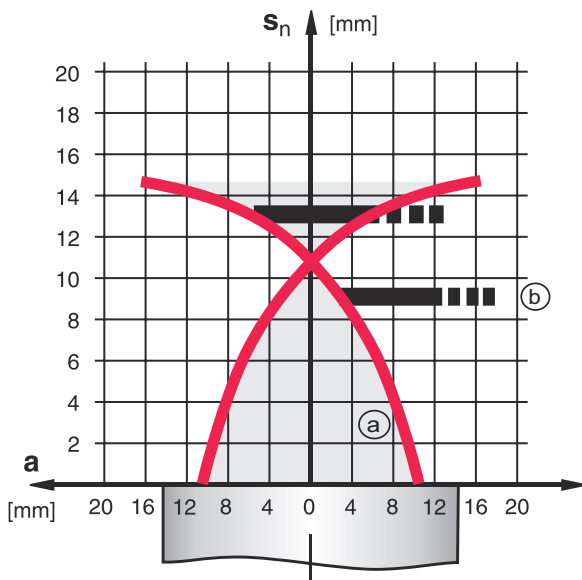

- a Inductive switch
- b Standard measuring plate



Operation and display

LED	Display	Meaning
1	Yellow, continuous light	Switching output/switching state

Part number code

Part designation: **ISX** **YYY** **ZZ/AAA**.**BB-CCC-DDD-DDD**



ISX	Operating principle / construction IS: inductive switch, standard design ISS: inductive switch, short construction
YYY	Series 203: series with Ø 3 mm 204: series with Ø 4 mm 205: series with M5 x 0.5 external thread 206: series with Ø 6.5 mm 208: series with M8 x 1 external thread 212: series with M12 x 1 external thread 218: series with M18 x 1 external thread 230: series with M30 x 1.5 external thread 240: series in cubic design 244: series in cubic design 255: series with 5 x 5 mm ² cross section 288: series with 8 x 8 mm ² cross section
ZZ	Housing / thread MM: metal housing (active surface: plastic) / metric thread FM: full-metal housing (active surface: stainless steel AISI 316L) / metric thread MP: metal housing (active surface: plastic) / smooth (without thread)
AAA	Output current / supply 4NO: PNP transistor, NO contact 4NC: PNP transistor, NC contact 2NO: NPN transistor, NO contact 2NC: NPN transistor, NC contact 1NO: relay, NO contact / AC/DC 1NC: relay, NC contact / AC/DC 44: 2 PNP transistor switching outputs, antivalent (NO + NC) 22: 2 NPN transistor switching outputs, antivalent (NO + NC)
BB	Special equipment n/a: no special equipment 5F: food version 5: housing material V2A (1.4305, AISI 303)
CCC	Measurement range / type of installation 1E0: typ. range limit 1.0 mm / embedded installation 1E5: typ. range limit 1.5 mm / embedded installation 2E0: typ. range limit 2.0 mm / embedded installation 3E0: typ. range limit 3.0 mm / embedded installation 4E0: typ. range limit 4.0 mm / embedded installation 5E0: typ. range limit 5.0 mm / embedded installation 6E0: typ. range limit 6.0 mm / embedded installation 8E0: typ. range limit 8.0 mm / embedded installation 10E: typ. range limit 10.0 mm / embedded installation 12E: typ. range limit 12.0 mm / embedded installation 15E: typ. range limit 15.0 mm / embedded installation 20E: typ. range limit 20.0 mm / embedded installation 22E: typ. range limit 22.0 mm / embedded installation 2N5: typ. range limit 2.5 mm / non-embedded installation 4N0: typ. range limit 4.0 mm / non-embedded installation 8N0: typ. range limit 8.0 mm / non-embedded installation 10N: typ. range limit 10.0 mm / non-embedded installation 12N: typ. range limit 12.0 mm / non-embedded installation 14N: typ. range limit 14.0 mm / non-embedded installation 15N: typ. range limit 15.0 mm / non-embedded installation 20N: typ. range limit 20.0 mm / non-embedded installation 22N: typ. range limit 22.0 mm / non-embedded installation 25N: typ. range limit 25.0 mm / non-embedded installation 40N: typ. range limit 40.0 mm / non-embedded installation
DDD	Electrical connection n/a: cable, standard length 2000 mm S12: M12 connector, 4-pin, axial 200-S12: cable, length 200 mm with M12 connector, 4-pin, axial 200-S8.3: cable, length 200 mm with M8 connector, 3-pin, axial S8.3: M8 connector, 3-pin, axial 005-S8.3: cable, length 500 mm with M8 connector, 3-pin, axial 050: cable, standard length 5000 mm, 3-wire



Note



A list with all available device types can be found on the Leuze website at www.leuze.com.



Notes

 Observe intended use!	
	<ul style="list-style-type: none"> ⌘ This product is not a safety sensor and is not intended as personnel protection. ⌘ The product may only be put into operation by competent persons. ⌘ Only use the product in accordance with its intended use.

 For UL applications:	
	<ul style="list-style-type: none"> ⌘ For UL applications, use is only permitted in Class 2 circuits in accordance with the NEC (National Electric Code).

Accessories

Mounting technology - Other

	Part no.	Designation	Article	Description
	50132730	AC D30M-CS	Clamp	Diameter, inner: 30 mm Design of mounting device: Mounting clamp Fastening, at system: Screw type, Through-hole mounting Mounting bracket, at device: insertable, Clampable with limit stop Type of mounting device: Clampable, With limit stop Material: Metal
	50111503	MC 030K	Clamp	Diameter, inner: 30 mm Design of mounting device: Mounting clamp Fastening, at system: Through-hole mounting Mounting bracket, at device: Clampable Type of mounting device: Rigid Material: Plastic

Note	
	<ul style="list-style-type: none"> ⌘ A list with all available accessories can be found on the Leuze website in the Download tab of the article detailed page.