

Technical data sheet

Deflecting mirror

Part no.: 529603

UM60-300

Contents

- Technical data
- Dimensioned drawings



Figure can vary

Technical data

Basic data

Series	UM
Type, columns and mirrors	Deflecting mirror

Mechanical data

Dimension (W x H x L)	25 mm x 68 mm x 370 mm
Net weight	800 g
Housing color	Yellow, RAL 1021
Type of fastening	Groove mounting Swivel mount
Suitable for sensor	MLC 500, MLC 300 safety light curtains
Protected field height up to	300 mm
Mirror length	360 mm

Classification

Customs tariff number	70099200
eCl@ss 5.1.4	27279207
eCl@ss 8.0	27279207
eCl@ss 9.0	27273605
eCl@ss 10.0	27273605
eCl@ss 11.0	27273605
ETIM 5.0	EC002467
ETIM 6.0	EC002467
ETIM 7.0	EC002467

Dimensioned drawings

All dimensions in millimeters

Mirror

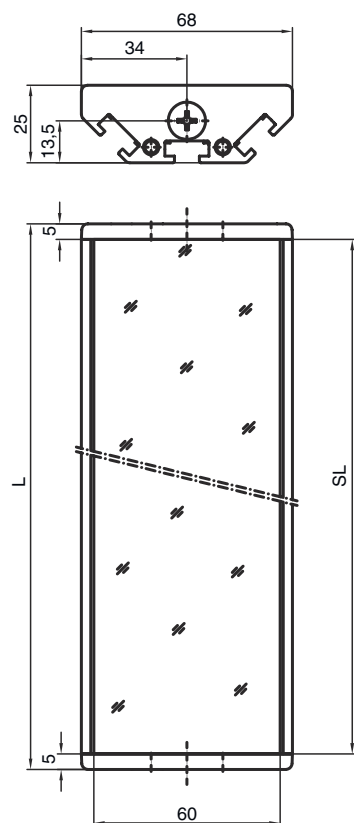

L Length = 370 mm
SL Mirror length = 360 mm

Dimensioned drawings

Mounting distances

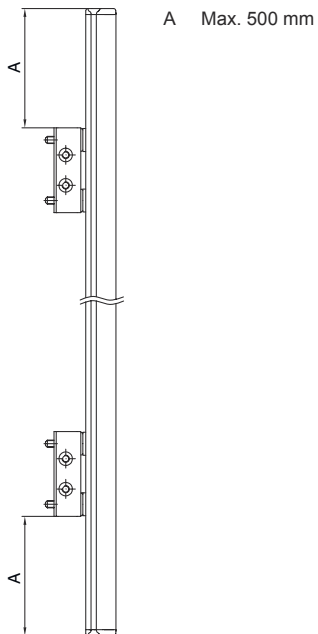

Mounting with BT-UM60 standard bracket

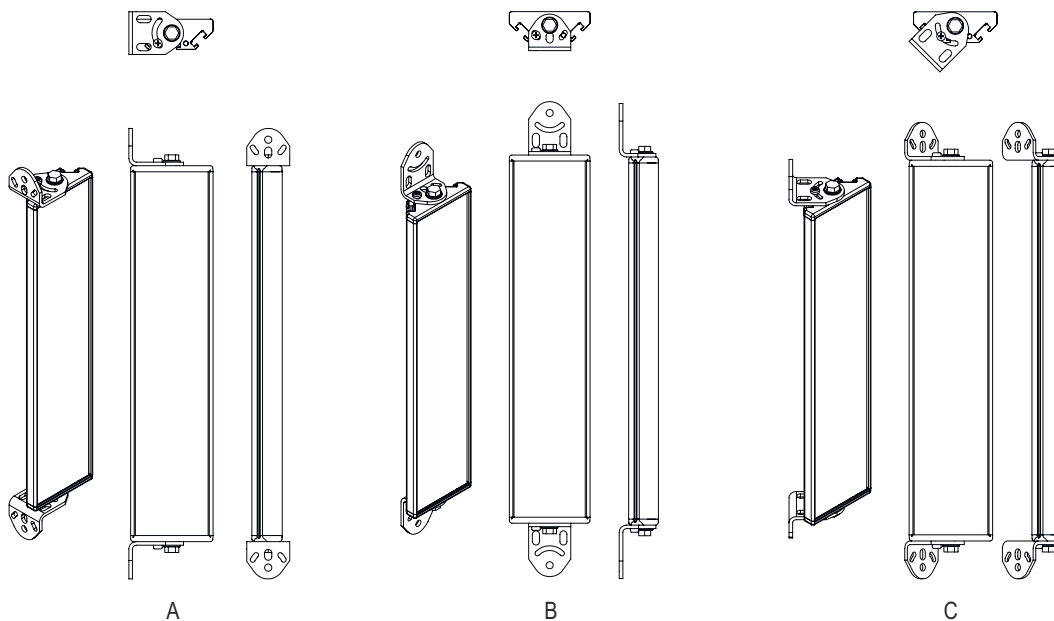

- A Lateral
- B Rear side
- C Adjustable at an angle (0 - 90°)

Dimensioned drawings

Mounting with BT-UM60 standard bracket

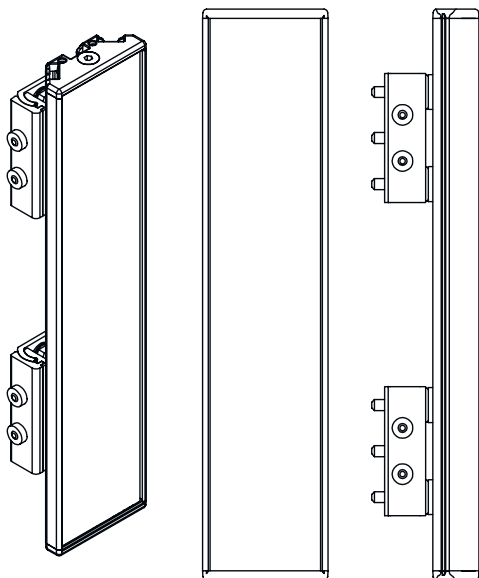
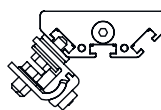
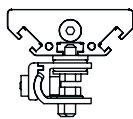

A

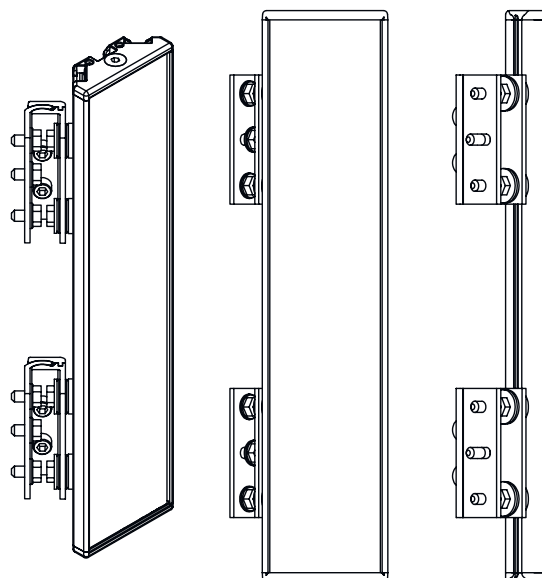

B

- A Rear side
- B Lateral 45°