

Technical data sheet Safety light curtain receiver

Part no.: 68017109

MLC510R14-900H/A



Contents

- Technical data
- Dimensioned drawings
- Electrical connection
- Operation and display
- Suitable transmitters
- Part number code
- Notes
- Accessories



Technical data

Basic data

Series	MLC 500
Device type	Receiver
Cascading	Host
Contains	2x BT-NC sliding block
Application	Finger protection

Characteristic parameters

Type	4, IEC/EN 61496
SIL	3, IEC 61508
SILCL	3, IEC/EN 62061
Performance Level (PL)	e, EN ISO 13849-1
PFH _D	7.73E-09 per hour
Mission time T _M	20 years, EN ISO 13849-1
Category	4, EN ISO 13849

Protective field data

Resolution	14 mm
Protective field height	900 mm

Optical data

Number of beams	90 Piece(s)
Synchronization	Optical between transmitter and receiver

Electrical data

Protective circuit	Overvoltage protection Short circuit protected
--------------------	---

Performance data

Supply voltage U _B	26.5 ... 31.6 V
Current consumption from AS-i circuit	150 mA

Timing

Response time	20 ms
Restart delay time	100 ms

Interface

Type	AS-Interface Safety at Work
AS-i	
Function	Process
AS-i profile	S-0.B.F
Slave address	1..31 programmable, default=0
Cycle time acc. to AS-i specifications	Max. 5 ms ms

Connection

Number of connections	2 Piece(s)
Connection 1	
Function	Machine interface
Type of connection	Connector
Thread size	M12
Material	Metal
No. of pins	5 -pin

Connection 2

Function	Cascade, Guest Out Cascade, Middle Guest Out
Type of connection	Cable with connector
Cable length	330 mm
Sheathing material	PUR
Thread size	M12
Material	Plastic
No. of pins	8 -pin

Cable properties

Permissible conductor cross section, typ.	0.25 mm ²
Length of connection cable, max.	100 m
Permissible cable resistance to load, max.	200 Ω

Mechanical data

Dimension (W x H x L)	29 mm x 966 mm x 35.4 mm
Housing material	Metal
Metal housing	Aluminum
Lens cover material	Plastic / PMMA
Material of end caps	Diecast zinc
Net weight	1,125 g
Housing color	Yellow, RAL 1021
Type of fastening	Groove mounting Mounting bracket Swivel mount

Operation and display

Type of display	LED
Number of LEDs	2 Piece(s)

Environmental data

Ambient temperature, operation	0 ... 55 °C
Ambient temperature, storage	-30 ... 70 °C
Relative humidity (non-condensing)	0 ... 95 %

Certifications

Degree of protection	IP 65
Protection class	III
Certifications	c CSA US c TÜV NRTL US TÜV Süd
Vibration resistance	50 m/s ²
Shock resistance	100 m/s ²
US patents	US 6,418,546 B

Classification

Customs tariff number	85365019
eCl@ss 5.1.4	27272704
eCl@ss 8.0	27272704
eCl@ss 9.0	27272704
eCl@ss 10.0	27272704
eCl@ss 11.0	27272704
ETIM 5.0	EC002549
ETIM 6.0	EC002549
ETIM 7.0	EC002549

Dimensioned drawings

All dimensions in millimeters

Calculation of the effective protective field height $H_{PFE} = H_{PFN} + B + C$

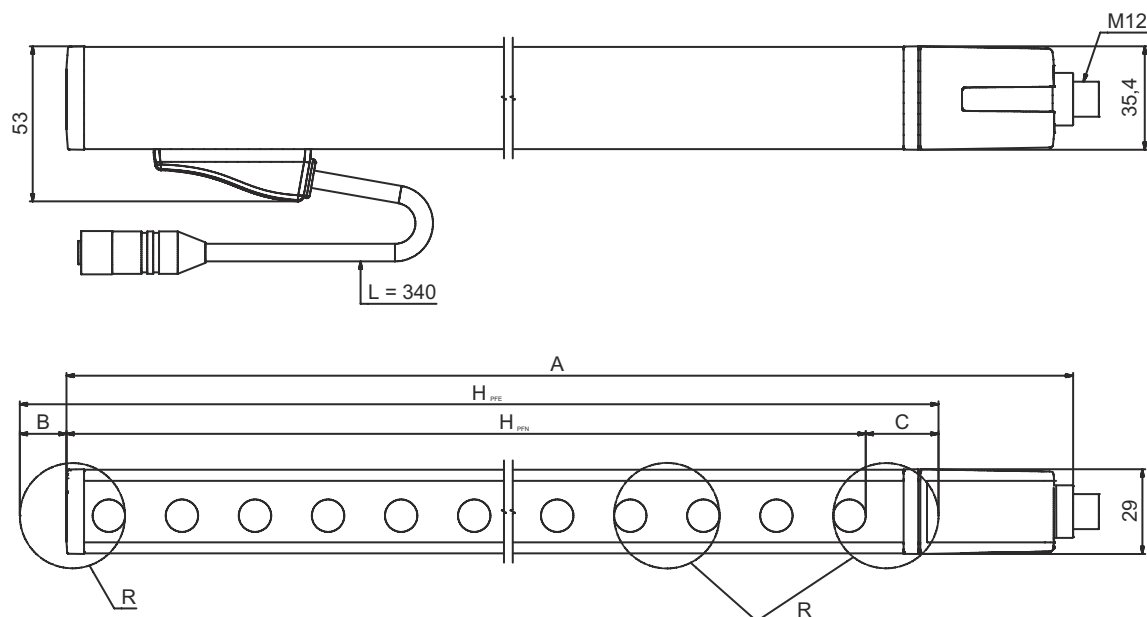

H_{PFE} Effective protective field height = 912 mm

H_{PFN} Nominal protective field height = 900 mm

A Total height = 966 mm

B 6 mm

C 6 mm

R Effective protective field height H_{PFE} goes beyond the dimensions of the optics area to the outer borders of the circles labeled with R.

Electrical connection

Connection 1

Function	Machine interface
Type of connection	Connector
Thread size	M12
Type	Male
Material	Metal
No. of pins	5 -pin
Encoding	A-coded

Pin Pin assignment

1	AS-i+
2	n.c.
3	AS-i-
4	n.c.
5	n.c.

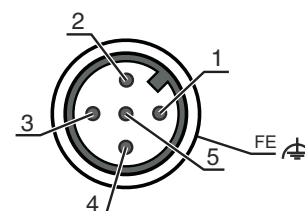

Connection 2

Function	Cascade, Guest Out Cascade, Middle Guest Out
Type of connection	Cable with connector
Cable length	330 mm
Sheathing material	PUR
Cable color	Black

Electrical connection

Connection 2

Wire cross section	0.14 mm ²
Type of stranding	Pair stranding (twisted pair)
Thread size	M12
Type	Female
Material	Plastic
No. of pins	8 -pin
Encoding	A-coded

Operation and display

LED	Display	Meaning
1	Off	Device switched off
	Red, continuous light	Protective field interrupted
	Red, flashing, 1 Hz	External error
	Red, flashing, 10 Hz	Internal error
	Green, flashing, 1 Hz	Protective field free, weak signal
	Green, continuous light	Protective field free
2	Off	No voltage
	On	OSSD off, transmission channel C2
	Green, continuous light	AS-i slave communicating with AS-i master
	Red, continuous light	AS-i slave not communicating with AS-i master
	Yellow, flashing	AS-i slave has invalid address 0
	Red, flashing	AS-i slave device error or AS-i connection defective
	Red/green, flashing alternately	Periphery error

Suitable transmitters

	Part no.	Designation	Article	Description
	68016109	MLC500T14-900H/A	Safety light curtain transmitter	Resolution: 14 mm Protective field height: 900 mm Operating range: 0 ... 6 m Interface: AS-Interface Safety at Work Connection: Connector, M12, Metal, 5 -pin

Part number code

Part designation: **MLC***xyy-za-hhhhei-ooo*

MLC	Safety light curtain
x	Series 3: MLC 300 5: MLC 500
yy	Function classes 00: transmitter 01: transmitter (AIDA) 02: transmitter with test input 10: basic receiver - automatic restart 11: basic receiver - automatic restart (AIDA) 20: standard receiver - EDM/RES selectable 30: extended receiver - blanking/muting
z	Device type T: transmitter R: receiver
a	Resolution 14: 14 mm 20: 20 mm 30: 30 mm 40: 40 mm 90: 90 mm

Part number code

MLC		Safety light curtain	
hhhh	Protective field height	150 ... 3000: from 150 mm to 3000 mm	
e	Host/Guest (optional)	H: Host MG: Middle Guest G: Guest	
i	Interface (optional)	/A: AS-i	
ooo	Option	/V: high Vibration-proof EX2: explosion protection (zones 2 + 22) SPG: Smart Process Gating	

Note



A list with all available device types can be found on the Leuze website at www.leuze.com.

Notes

Observe intended use!



- The product may only be put into operation by competent persons.
- Only use the product in accordance with its intended use.

Accessories

Connection technology - Interconnection cables

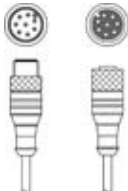
	Part no.	Designation	Article	Description
	429278	CB-M12-2000E-8TP	Interconnection cable	Connection 1: Connector, M12, Axial, Female, A-coded, 8 -pin Connection 2: Connector, M12, Axial, Male, A-coded, 8 -pin Shielded: Yes Cable length: 2,000 mm Sheathing material: PUR

Mounting technology - Swivel mounts

	Part no.	Designation	Article	Description
	429393	BT-2HF	Mounting bracket set	Fastening, at system: Through-hole mounting Mounting bracket, at device: Clampable Type of mounting device: Turning, 360° Material: Metal, Plastic

Accessories

Services

	Part no.	Designation	Article	Description
	S981050	CS40-I-140	Safety inspection "Safety light barriers"	<p>Details: Checking of a safety light barrier application in accordance with current standards and guidelines. Inclusion of the device and machine data in a database, production of a test log per application.</p> <p>Conditions: It must be possible to stop the machine, support provided by customer's employees and access to the machine for Leuze employees must be ensured.</p> <p>Restrictions: Travel costs and accommodation expenses charged separately and according to expenditure.</p>
	S981046	CS40-S-140	Start-up support	<p>Details: For safety devices including stopping time measurement and initial inspection.</p> <p>Conditions: Devices and connection cables are already mounted, price not including travel costs and, if applicable, accommodation expenses.</p> <p>Restrictions: Max. 2 h., no mechanical (mounting) and electrical (wiring) work performed, no changes (attachments, wiring, programming) to third-party components in the nearby environment.</p>

Note



A list with all available accessories can be found on the Leuze website in the Download tab of the article detailed page.