

## Technical data sheet

### Inductive switch

Part no.: 50109702

IS 218MM/4NC-8E0-S12

#### Contents

- Technical data
- Dimensioned drawings
- Electrical connection
- Diagrams
- Operation and display
- Part number code
- Notes
- Accessories



Figure can vary



## Technical data

### Basic data

Series	218
Typ. operating range limit $S_n$	8 mm
Operating range $S_a$	0 ... 6.4 mm

### Characteristic parameters

MTTF	900 years
------	-----------

### Electrical data

Protective circuit	Inductive protection
	Polarity reversal protection
	Short circuit protected

### Performance data

Supply voltage $U_B$	10 ... 30 V, DC
Residual ripple	0 ... 20 %, From $U_B$
Open-circuit current	0 ... 10 mA
Temperature drift, max. (in % of $S_r$ )	10 %, Over the entire operating temperature range
Repeatability, max. (in % of $S_r$ )	5 %, For $U_B = 20 \dots 30$ VDC, ambient temperature $T_a = 23^\circ\text{C} \pm 5^\circ\text{C}$
Switching hysteresis	10 %

### Outputs

Number of digital switching outputs	1 Piece(s)
-------------------------------------	------------

### Switching outputs

Voltage type	DC
Switching current, max.	200 mA
Residual current, max.	0.1 mA
Voltage drop	$\leq 2$ V

### Switching output 1

Switching element	Transistor, PNP
Switching principle	NC (normally closed)

### Timing

Switching frequency	1,500 Hz
Readiness delay	60 ms

### Connection

Number of connections	1 Piece(s)
-----------------------	------------

### Connection 1

Function	Signal OUT
	Voltage supply
Type of connection	Connector
Thread size	M12
Type	Male
Material	Metal
No. of pins	4 -pin
Encoding	A-coded

### Mechanical data

Design	Cylindrical
Thread size	M18 x 1 mm
Dimension ( $\varnothing$ x L)	18 mm x 63.5 mm
Type of installation	Embedded
Housing material	Metal
Metal housing	Nickel-plated brass
Sensing face material	Plastic, Polybutylene (PBT)
Net weight	51 g
Housing color	Red, RAL 3000
	Silver
Type of fastening	Mounting thread
Standard measuring plate	24 x 24 mm <sup>2</sup> , Fe360

### Operation and display

Type of display	LED
Number of LEDs	1 Piece(s)

### Environmental data

Ambient temperature, operation	-25 ... 70 °C
Ambient temperature, storage	-25 ... 70 °C

### Certifications

Degree of protection	IP 67
Protection class	II
Certifications	c UL US
Test procedure for EMC in accordance with standard	IEC 61000-4-2
	IEC 61000-4-3
	IEC 61000-4-4
Standards applied	IEC 60947-5-2

### Correction factors

Aluminum	0.35
Stainless steel	0.7
Copper	0.3
Brass	0.4
Fe360 steel	1

### Classification

Customs tariff number	85365019
eCl@ss 5.1.4	27270101
eCl@ss 8.0	27270101
eCl@ss 9.0	27270101
eCl@ss 10.0	27270101
eCl@ss 11.0	27270101
ETIM 5.0	EC002714
ETIM 6.0	EC002714
ETIM 7.0	EC002714

# Dimensioned drawings

All dimensions in millimeters

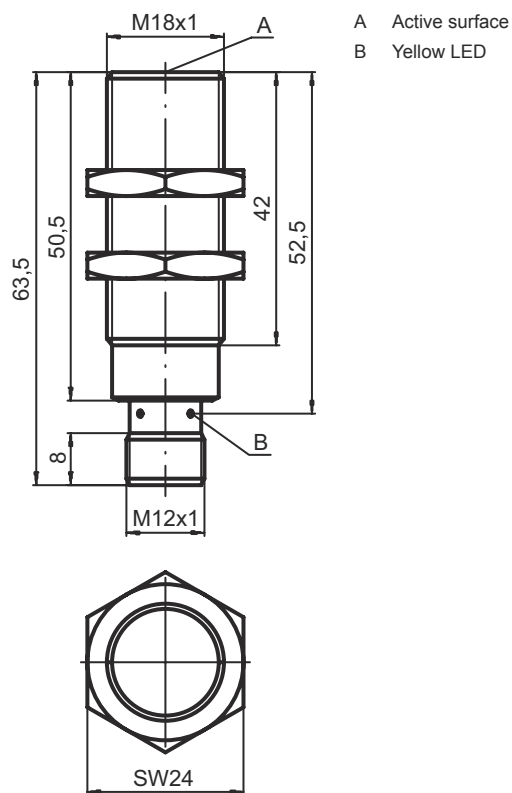

A Active surface  
B Yellow LED

## Electrical connection

### Connection 1

Function	Signal OUT Voltage supply
Type of connection	Connector
Thread size	M12
Type	Male
Material	Metal
No. of pins	4 -pin
Encoding	A-coded

Pin	Pin assignment
1	V+
2	OUT 1
3	GND
4	n.c.

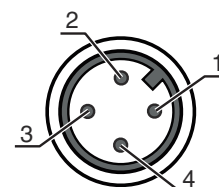

# Diagrams

## Embedded installation

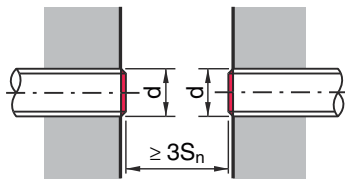
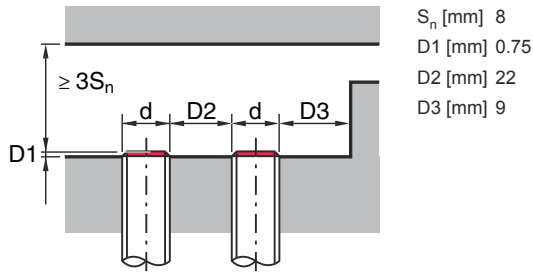

## Types with $S_n = 8.0$ mm

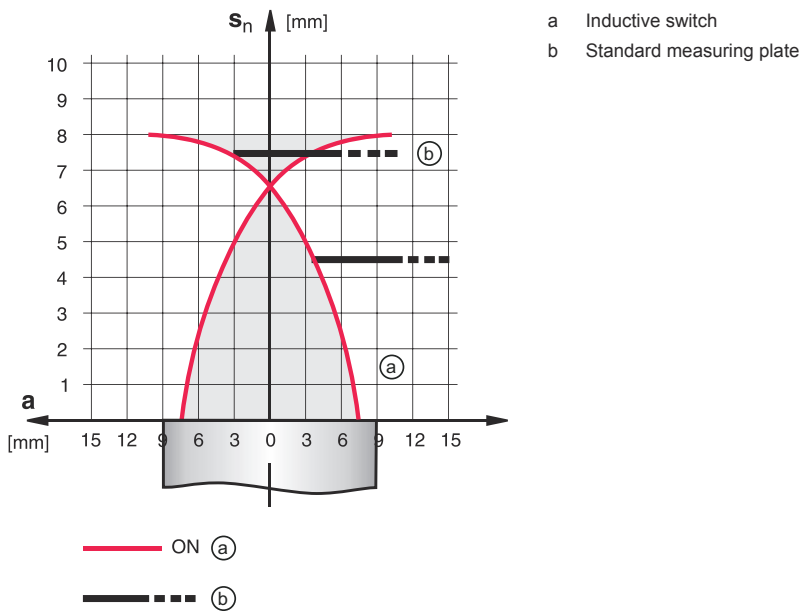

## Operation and display

LED	Display	Meaning
1	Yellow, continuous light	Switching output/switching state

## Part number code

Part designation: ISX YYY ZZ/AAA.BB-CCC-DDD-DDD

ISX	Operating principle / construction
	IS: inductive switch, standard design ISS: inductive switch, short construction

## Part number code

<b>YYY</b>	<p><b>Series</b></p> <p>203: series with Ø 3 mm                  204: series with Ø 4 mm                  205: series with M5 x 0.5 external thread                  206: series with Ø 6.5 mm                  208: series with M8 x 1 external thread                  212: series with M12 x 1 external thread                  218: series with M18 x 1 external thread                  230: series with M30 x 1.5 external thread                  240: series in cubic design                  244: series in cubic design                  255: series with 5 x 5 mm<sup>2</sup> cross section                  288: series with 8 x 8 mm<sup>2</sup> cross section</p>
<b>ZZ</b>	<p><b>Housing / thread</b></p> <p>MM: metal housing (active surface: plastic) / metric thread                  FM: full-metal housing (active surface: stainless steel AISI 316L) / metric thread                  MP: metal housing (active surface: plastic) / smooth (without thread)</p>
<b>AAA</b>	<p><b>Output current / supply</b></p> <p>4NO: PNP transistor, NO contact                  4NC: PNP transistor, NC contact                  2NO: NPN transistor, NO contact                  2NC: NPN transistor, NC contact                  1NO: relay, NO contact / AC/DC                  1NC: relay, NC contact / AC/DC                  44: 2 PNP transistor switching outputs, antivalent (NO + NC)                  22: 2 NPN transistor switching outputs, antivalent (NO + NC)</p>
<b>BB</b>	<p><b>Special equipment</b></p> <p>n/a: no special equipment                  5F: food version                  5: housing material V2A (1.4305, AISI 303)</p>
<b>CCC</b>	<p><b>Measurement range / type of installation</b></p> <p>1E0: typ. range limit 1.0 mm / embedded installation                  1E5: typ. range limit 1.5 mm / embedded installation                  2E0: typ. range limit 2.0 mm / embedded installation                  3E0: typ. range limit 3.0 mm / embedded installation                  4E0: typ. range limit 4.0 mm / embedded installation                  5E0: typ. range limit 5.0 mm / embedded installation                  6E0: typ. range limit 6.0 mm / embedded installation                  8E0: typ. range limit 8.0 mm / embedded installation                  10E: typ. range limit 10.0 mm / embedded installation                  12E: typ. range limit 12.0 mm / embedded installation                  15E: typ. range limit 15.0 mm / embedded installation                  20E: typ. range limit 20.0 mm / embedded installation                  22E: typ. range limit 22.0 mm / embedded installation                  2N5: typ. range limit 2.5 mm / non-embedded installation                  4N0: typ. range limit 4.0 mm / non-embedded installation                  8N0: typ. range limit 8.0 mm / non-embedded installation                  10N: typ. range limit 10.0 mm / non-embedded installation                  12N: typ. range limit 12.0 mm / non-embedded installation                  14N: typ. range limit 14.0 mm / non-embedded installation                  15N: typ. range limit 15.0 mm / non-embedded installation                  20N: typ. range limit 20.0 mm / non-embedded installation                  22N: typ. range limit 22.0 mm / non-embedded installation                  25N: typ. range limit 25.0 mm / non-embedded installation                  40N: typ. range limit 40.0 mm / non-embedded installation</p>
<b>DDD</b>	<p><b>Electrical connection</b></p> <p>n/a: cable, standard length 2000 mm                  S12: M12 connector, 4-pin, axial                  200-S12: cable, length 200 mm with M12 connector, 4-pin, axial                  200-S8.3: cable, length 200 mm with M8 connector, 3-pin, axial                  S8.3: M8 connector, 3-pin, axial                  005-S8.3: cable, length 500 mm with M8 connector, 3-pin, axial                  050: cable, standard length 5000 mm, 3-wire</p>

**Note**



A list with all available device types can be found on the Leuze website at [www.leuze.com](http://www.leuze.com).

## Notes

<b>Observe intended use!</b>	
	<ul style="list-style-type: none"> <li>⌘ This product is not a safety sensor and is not intended as personnel protection.</li> <li>⌘ The product may only be put into operation by competent persons.</li> <li>⌘ Only use the product in accordance with its intended use.</li> </ul>

<b>For UL applications:</b>	
	<ul style="list-style-type: none"> <li>⌘ For UL applications, use is only permitted in Class 2 circuits in accordance with the NEC (National Electric Code).</li> </ul>



## Accessories

### Connection technology - Connection cables

	Part no.	Designation	Article	Description
	50130654	KD U-M12-4A-P1-020	Connection cable	Connection 1: Connector, M12, Axial, Female, A-coded, 4 -pin Connection 2: Open end Shielded: No Cable length: 2,000 mm Sheathing material: PUR
	50130657	KD U-M12-4A-P1-050	Connection cable	Connection 1: Connector, M12, Axial, Female, A-coded, 4 -pin Connection 2: Open end Shielded: No Cable length: 5,000 mm Sheathing material: PUR
	50130648	KD U-M12-4A-V1-020	Connection cable	Connection 1: Connector, M12, Axial, Female, A-coded, 4 -pin Connection 2: Open end Shielded: No Cable length: 2,000 mm Sheathing material: PVC
	50130688	KD U-M12-4W-V1-020	Connection cable	Connection 1: Connector, M12, Angled, Female, A-coded, 4 -pin Connection 2: Open end Shielded: No Cable length: 2,000 mm Sheathing material: PVC

## Accessories

### Mounting technology - Other

	Part no.	Designation	Article	Description
	50132729	AC D18M-CS	Clamp	Diameter, inner: 18 mm Design of mounting device: Mounting clamp Fastening, at system: Screw type, Through-hole mounting Mounting bracket, at device: insertable, Clampable with limit stop Type of mounting device: Clampable, With limit stop Material: Metal
	50111501	MC 018K	Clamp	Diameter, inner: 18 mm Design of mounting device: Mounting clamp Fastening, at system: Through-hole mounting Mounting bracket, at device: Clampable Type of mounting device: Rigid Material: Plastic

#### Note



A list with all available accessories can be found on the Leuze website in the Download tab of the article detailed page.