

## Technical data sheet

### Single beam safety device receiver

Part no.: 66533001

MLD510-R1/A



Figure can vary

#### Contents

- Technical data
- Dimensioned drawings
- Electrical connection
- Operation and display
- Suitable transmitters
- Part number code
- Accessories



## Technical data

### Basic data

Series	MLD 500
--------	---------

### Functions

Functions	Automatic restart
-----------	-------------------

### Characteristic parameters

Type	4, IEC/EN 61496
SIL	3, IEC 61508
SILCL	3, IEC/EN 62061
Performance Level (PL)	e, EN ISO 13849-1:2008
MTTF <sub>d</sub>	204 years, EN ISO 13849-1
PFH <sub>d</sub>	6.6E-09 per hour
Mission time T <sub>M</sub>	20 years, EN ISO 13849-1
Category	4, EN ISO 13849

### Electrical data

#### Performance data

Supply voltage U <sub>B</sub>	26.5 ... 31.6 V
Current consumption from AS-i circuit	140 mA

### Timing

Response time	30 ms
Restart delay time	100 ms

### Interface

Type	AS-Interface Safety at Work
------	-----------------------------

#### AS-i

Function	Process
AS-i profile	S-7.B.1
Slave address	1..31 programmable, default=0
Cycle time acc. to AS-i specifications	Max. 5 ms ms

### Connection

Number of connections	1 Piece(s)
-----------------------	------------

#### Connection 1

Function	Machine interface
Type of connection	Connector
Thread size	M12
Material	Metal
No. of pins	5 -pin

### Mechanical data

Design	Cubic
Dimension (W x H x L)	52 mm x 193 mm x 64.7 mm
Housing material	Metal
Metal housing	Aluminum
Lens cover material	Plastic / PMMA
Material of end caps	Diecast zinc
Net weight	600 g
Housing color	Yellow, RAL 1021
Type of fastening	Groove mounting Swivel mount

### Operation and display

Type of display	Integrated muting indicator LED
Number of LEDs	2 Piece(s)

### Environmental data

Ambient temperature, operation	-30 ... 55 °C
Ambient temperature, storage	-40 ... 75 °C
Relative humidity (non-condensing)	0 ... 95 %

### Certifications

Degree of protection	IP 67
Protection class	III
Certifications	c CSA US c TÜV NRTL US TÜV Süd
US patents	US 6,418,546 B US 7,741,595 B

### Classification

Customs tariff number	85365019
eCl@ss 5.1.4	27272701
eCl@ss 8.0	27272701
eCl@ss 9.0	27272701
eCl@ss 10.0	27272701
eCl@ss 11.0	27272701
ETIM 5.0	EC001831
ETIM 6.0	EC001831
ETIM 7.0	EC001831

## Dimensioned drawings

All dimensions in millimeters

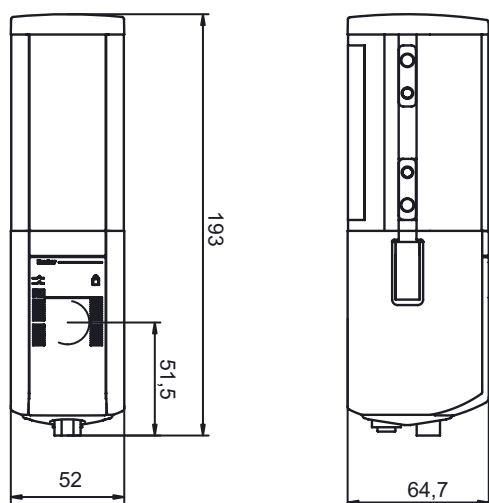

## Electrical connection

### Connection 1

Function	Machine interface
Type of connection	Connector
Thread size	M12
Type	Male
Material	Metal
No. of pins	5 -pin
Encoding	A-coded

Pin	Pin assignment	Conductor color
1	AS-+	Brown
2	n.c.	White
3	AS-	Blue
4	n.c.	Black
5	n.c.	Gray

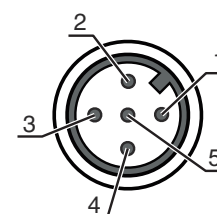

## Operation and display

LED	Display	Meaning
1	Red, continuous light	OSSD off.
	Green, continuous light	OSSD on
	Red, flashing, 1 Hz	External error
	Red, flashing, 10 Hz	Internal error
	Green, flashing, 1 Hz	Weak signal, device not optimally aligned or soiled.
2	Yellow, continuous light	Start/restart interlock locked.
	Off	No voltage on AS-i cable.
	Red, continuous light	AS-i slave not communicating with AS-i master
	Yellow, flashing	AS-i slave has invalid address 0
	Red/green, flashing alternately	AS-i slave device error or AS-i connection defective
	Green, continuous light, flashing red at the same time	Periphery error
	Green, continuous light	AS-i slave communicating with AS-i master

## Suitable transmitters

	Part no.	Designation	Article	Description
	66501001	MLD500-T1/A	Single beam safety device transmitter	Operating range: 0.5 ... 70 m Light source: LED, Infrared Type of interface: AS-Interface Safety at Work Connection: Connector, M12, Metal, 5 -pin

## Part number code

Part designation: MLDxyy-zab/t

<b>MLD</b>	<b>Multiple light beam safety device</b>
<b>x</b>	<b>Series</b> 3: MLD 300 5: MLD 500
<b>yy</b>	<b>Function classes</b> 00: transmitter 10: automatic restart 12: external testing 20: EDM/RES 30: muting 35: timing controlled 4-sensor muting
<b>z</b>	<b>Device type</b> T: transmitter R: receiver RT: transceiver xT: transmitter with high range xR: receiver for high range
<b>a</b>	Number of beams
<b>b</b>	<b>Option</b> L: integrated laser alignment aid (for transmitter/receiver) M: integrated status indicator (MLD 320, MLD 520) or integrated status and muting indicator (MLD 330, MLD 335, MLD 510/A, MLD 530, MLD 535) E: connection socket for external muting indicator (AS-i models only)
<b>/t</b>	<b>Safety-related switching outputs (OSSDs), connection technology</b> -: transistor output, M12 plug A: integrated AS-i interface, M12 plug, (safety bus system)

### Note





A list with all available device types can be found on the Leuze website at [www.leuze.com](http://www.leuze.com).

## Accessories

### Connection technology - Connection cables

	Part no.	Designation	Article	Description
	50133859	KD S-M12-5A-P1-020	Connection cable	Connection 1: Connector, M12, Axial, Female, A-coded, 5 -pin Connection 2: Open end Shielded: Yes Cable length: 2,000 mm Sheathing material: PUR

## Accessories

	Part no.	Designation	Article	Description
	50137014	KD S-M12-5A-P1-150	Connection cable	Connection 1: Connector, M12, Axial, Female, A-coded, 5 -pin Connection 2: Open end Shielded: Yes Cable length: 15,000 mm Sheathing material: PUR
	50136146	KD S-M12-5A-P1-250	Connection cable	Connection 1: Connector, M12, Axial, Female, A-coded, 5 -pin Connection 2: Open end Shielded: Yes Cable length: 10,000 mm Sheathing material: PVC

## Muting - Mounting systems

	Part no.	Designation	Article	Description
	424421	BT-SB10	Mounting bracket set	Design of mounting device: Mounting clamp Fastening, at system: Through-hole mounting Mounting bracket, at device: Clampable Type of mounting device: Swiveling Swivel range: -8 ... 8 ° Material: Metal

## Services

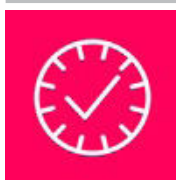
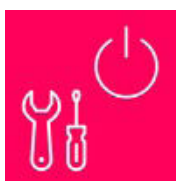
	Part no.	Designation	Article	Description
	S981050	CS40-I-140	Safety inspection "Safety light barriers"	Details: Checking of a safety light barrier application in accordance with current standards and guidelines. Inclusion of the device and machine data in a database, production of a test log per application. Conditions: It must be possible to stop the machine, support provided by customer's employees and access to the machine for Leuze employees must be ensured. Restrictions: Travel costs and accommodation expenses charged separately and according to expenditure.
	S981046	CS40-S-140	Start-up support	Details: For safety devices including stopping time measurement and initial inspection. Conditions: Devices and connection cables are already mounted, price not including travel costs and, if applicable, accommodation expenses. Restrictions: Max. 2 h., no mechanical (mounting) and electrical (wiring) work performed, no changes (attachments, wiring, programming) to third-party components in the nearby environment.

### Note



A list with all available accessories can be found on the Leuze website in the Download tab of the article detailed page.