

KRTW 3B

White light contrast scanner

en 07-2016/01 50110626-04



Dimensioned drawing

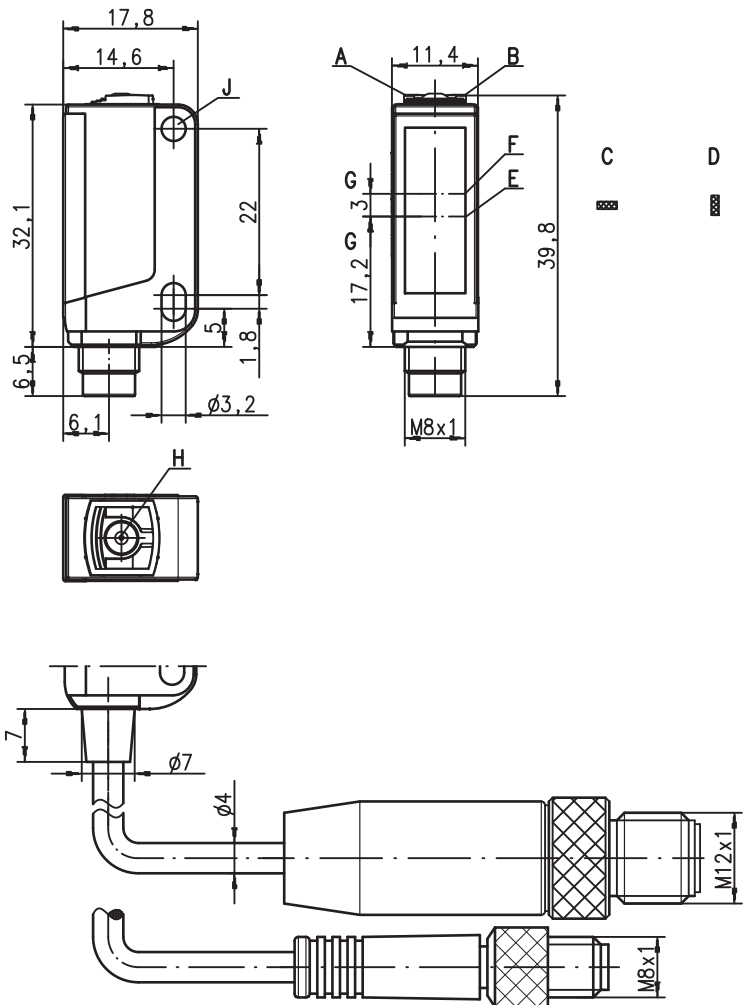

- A Green indicator diode
- B Yellow indicator diode
- C Light spot orientation horizontal
- D Light spot orientation vertical
- E Transmitter
- F Receiver
- G Optical axis
- H Teach button
- J Attachment sleeve

14.5 mm

- White light transmitter
- Various teach variants
- Short response time
- Switching threshold adjustment via EasyTune
- Level adaptation for glossy objects
- Keyboard lockout
- Remote teach via cable
- Pulse stretching 20ms

Electrical connection

Plug connection, 4-pin

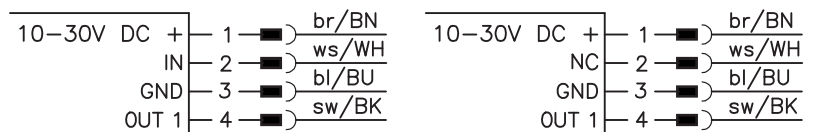

We reserve the right to make changes • DS_KRTW3B_en_50110626_04.fm

Accessories:

- (available separately)
- Mounting systems (BT 3...)
 - Cable with M8 or M12 connector (K-D ...)

Specifications

		KRTW 3B/...10-S8	KRTW 3B/...21-S8
Optical data			
Scanning range ¹⁾		14.5mm ± 2mm	
Light spot dimensions		1.5mm x 4mm (at a distance of 14.5mm)	
Light spot orientation		vertical or horizontal (see dimensioned drawing)	
Light source ²⁾		white LED (optimized through YellowBoost)	
Wavelength		430 ... 700nm	
Sensor operating modes			
IO-Link		COM2 (38.4kBaud)	
SIO		standard push-pull	
Dual Core		no	
Timing of the sensor			
Internal switching frequency		6kHz	10kHz
Internal response time		83µs	50µs
Response jitter, internal		20µs	20µs
Repeatability ³⁾		0.02mm	0.02mm
Delay before start-up		≤ 300ms	
Conveyor speed during teach		≤ 0.1 m/s for a mark width of 1mm	
Teach process		static 1-point, static 2-point or dynamic 2-point	
Teach delay		≤ 10ms	
Timing of the outputs			
Response time	Pin 4	IO-Link COM2: acc. to IO-Link specification (typically 2.5ms)	
		SIO: 50µs	
Electrical data			
Operating voltage U_B ⁴⁾	with SIO	10 ... 30VDC (incl. residual ripple)	
	with COM2	18 ... 30VDC (incl. residual ripple)	
Residual ripple		≤ 15% of U_B	
Output/function	.../2...	pin 4: GND if mark detected	
	.../4...	pin 4: U_B if mark detected	
	.../6...	pin 4: IO-Link SIO mode, U_B if mark detected	
	.../6...	pin 4: IO-Link COM2 mode, see configuration file IODD	
Signal voltage high/low		≥ ($U_B - 2V$) / ≤ 2V	
Output current		max. 100mA	
Open-circuit current		≤ 20mA	
Indicators			
Green LED in continuous light		ready	
Green and yellow LED flashing at 3Hz		teach event active	
Green and yellow LED flashing at 8Hz		teaching error	
Green LED off and yellow LED flashing at 8Hz		sensor error	
Yellow LED in continuous light		mark detected (dependent on the teach sequence)	
Transmitter LED, white flashing at 8Hz		teaching error	
Mechanical data			
Housing		plastic (PC-ABS), with/without attachment sleeve, nickel-plated steel	
Optics cover		plastic (PMMA)	
Weight		with M8 metal plug: 10g with M8 plastic plug: 8g	
Connection type		M8 connector, metal or plastic	
Environmental data			
Ambient temp. (operation/storage)		-30°C ... +55°C / -30°C ... +70°C	
Protective circuit ⁵⁾		2, 3	
VDE safety class		III	
Protection class		IP 67	
Light source		free group (in accordance with EN 62471)	
Standards applied		IEC 60947-5-2	
Certifications		UL 508, CSA C22.2 No.14-13 ^{4) 6)}	
Options			
Input pin 2			
Function characteristics		keyboard lockout / line teach / pulse stretching	
Input active/not active		≥ 8V / ≤ 2V or not connected	
Output pin 4			
Line teach active	for SIO	2Hz at the switching output	
	for COM2	see configuration file IODD	
Error after line teach	for SIO	2Hz at the switching output	
	for COM2	see configuration file IODD	

Tables

Remarks

Operate in accordance with intended use!

- ⚠ This product is not a safety sensor and is not intended as personnel protection.
- ⚠ The product may only be put into operation by competent persons.
- ⚠ Only use the product in accordance with the intended use.

UL REQUIREMENTS

Enclosure Type Rating: Type 1
For Use in NFPA 79 Applications only.

Adapters providing field wiring means are available from the manufacturer. Refer to manufacturers information.

CAUTION – the use of controls or adjustments or performance of procedures other than those specified herein may result in hazardous radiation exposure.

ATTENTION ! Si d'autres dispositifs d'alignement que ceux préconisés ici sont utilisés ou s'il est procédé autrement qu'indiqué, cela peut entraîner une exposition à des rayonnements et un danger pour les personnes.

- With glossy objects, the sensor is to be fastened at an inclination of approx. 10° relative to the object surface.

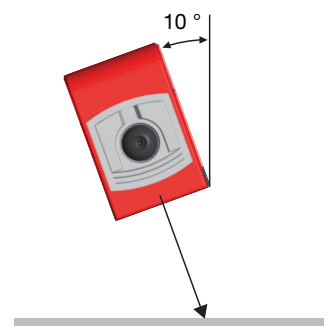

1) Scanning range: recommended range with performance reserve
 2) Average life expectancy 100,000h at an ambient temperature of 25°C
 3) At conveyor speed 1 m/s
 4) For UL applications: for use in class 2 circuits according to NEC only
 5) 2=polarity reversal protection, 3=short-circuit protection for all transistor outputs
 6) These proximity switches shall be used with UL Listed Cable assemblies rated 30V, 0.5A min, in the field installation, or equivalent (categories: CYJV/CYJV7 or PVVA/PVVA7)

KRTW 3B

White light contrast scanner

Order guide

Selection table		Order code →													
Equipment ↓		KRTW 3B/4.1110-S8 Part no. 50110572	KRTW 3B/4.1121-S8 Part no. 50110576	KRTW 3B/4.1321-S8 Part no. 50110580	KRTW 3B/6.1121-S8 Part no. 50111319	KRTW 3B/6.1321-S8 Part no. 50111320	KRTW 3B/2.1110-S8 Part no. 50110573	KRTW 3B/4.1110.200-S12 Part no. 50110574	KRTW 3B/2.1110.200-S12 Part no. 50110575	KRTW 3B/2.1121-S8 Part no. 50110577	KRTW 3B/4.1121.200-S12 Part no. 50110578	KRTW 3B/2.1121.200-S12 Part no. 50110579	KRTW 3B/2.1321-S8 Part no. 50110581	KRTW 3B/4.1321.200-S12 Part no. 50110582	KRTW 3B/2.1321.200-S12 Part no. 50110583
Transmitter color	white light	●	●	●	●	●	●	●	●	●	●	●	●	●	●
	RGB (red, green, blue)														
	laser-generated red light														
Light spot orientation	vertical	●	●	●	●	●	●	●	●	●	●	●	●	●	●
	horizontal														
	round														
Output (OUT 1)	PNP transistor output	●	●	●				●			●			●	
	NPN transistor output						●		●	●			●	●	●
	push-pull switching output				●	●									
	IO-Link COM2				●	●									
Input (IN)	teach input		●	●	●	●				●	●	●	●	●	●
Housing	standard		●	●	●	●				●	●	●	●	●	●
	economy	●					●	●	●						
Connection	M8 connector, metal			●	●	●				●			●		
	M8 connector, plastic	●					●								
	200mm cable with M12 connector							●	●		●	●		●	●
Teach-in method	static 1-point			●		●							●	●	●
	static 2-point	●	●		●		●	●	●	●	●	●			
	dynamic 2-point														
Response time / Switching frequency	50µs / 10kHz		●	●	●	●				●	●	●	●	●	●
	83µs / 6kHz	●					●	●	●						
	125µs / 4kHz														
Configuration	switching threshold adjustment with EasyTune via teach button		●	●	●	●				●	●	●	●	●	●
	remote teach, keyboard lockout and pulse stretching via pin 2		●	●	●	●				●	●	●	●	●	●
	teach level 1, teach-level 2 and pulse stretching via teach button		●	●	●	●				●	●	●	●	●	●
	teach level 1, teach-level 2 via teach button	●					●	●	●						

IO-Link process data

The sensor transmits 2 bytes to the master.

Data bit																Assignment	Default settings
15	14	13	12	11	10	9	8	7	6	5	4	3	2	1	0		
																Switching output	0 = no mark, 1 = mark detected
																Not used	Free
																Sensor operation	0 = off, 1 = on
																Switching threshold LSB	Value range 0 ... 31 (0 ... 100% in approx. 3% steps) 0% = min. switching threshold 100% = max. switching threshold
																Switching threshold	
																Switching threshold	
																Switching threshold	
																Switching threshold MSB	
																Active transmitter LSB	00 = red, 01 = green or white, 10 = blue, 11 = all colors on (teach-in active)
																Active transmitter MSB	
																Not used	Free
																Measurement value LSB	Value range 0 ... 31 (0 ... 100% in approx. 3% steps) 0% = min. signal level 100% = max. signal level
																Measurement value	
																Measurement value	
																Measurement value	
																Measurement value MSB	



Additional information on the IO-Link service data is available on request.

Static 2-point teach

Suitable for manual positioning of the marks (availability dependent on sensor type).

Switching threshold in center:

<p>Position the background.</p>	<p>Press teach button for 2 ... 7s and release.</p> <p>Value for background is accepted.</p>	<p>LEDs flash simultaneously.</p> <p>Simultaneous flashing</p>	<p>Position the mark.</p>	<p>Briefly press teach button.</p> <p>Value for mark is accepted.</p>	<p>Sensor in RUN mode. Yellow LED illuminates.</p> <p>Switching threshold set in the center.</p>
---------------------------------	--	---	---------------------------	---	--

Switching threshold near the mark:

<p>Position the background.</p>	<p>Press teach button for 7 ... 12s and release.</p> <p>Value for background is accepted.</p>	<p>LEDs flash alternately.</p> <p>Alternating flashing</p>	<p>Position the mark.</p>	<p>Briefly press teach button.</p> <p>Value for mark is accepted.</p>	<p>Sensor in RUN mode. Yellow LED illuminates.</p> <p>Switching threshold is set near the mark.</p>
---------------------------------	---	---	---------------------------	---	---





KRTW 3B

White light contrast scanner



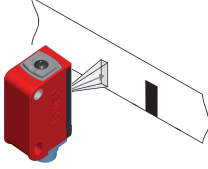
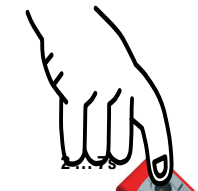

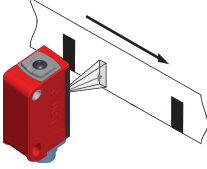
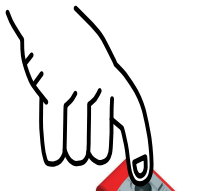
Dynamic 2-point teach

Suitable for marks moved during automated machine processes (availability dependent on sensor type).

Switching threshold in center

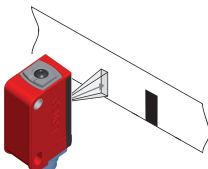
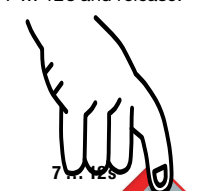
<p>Position the background.</p> 	<p>Press teach button for 2 ... 7s and release.</p>  <p>Measurement window opens.</p>	<p>LEDs flash simultaneously.</p>  <p>Simultaneous flashing</p>	<p>Allow marks to pass through dynamically.</p> 	<p>Briefly press teach button.</p>  <p>Measurement window closes.</p>	<p>Sensor in RUN mode. Yellow LED is off.</p>  <p>Switching threshold set in the center.</p>
---	--	---	---	--	---

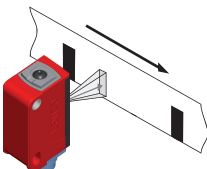
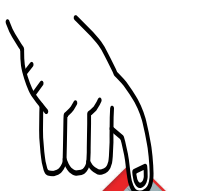



Switching threshold near the mark

<p>Position the background.</p> 	<p>Press teach button for 7 ... 12s and release.</p>  <p>Measurement window opens.</p>	<p>LEDs flash alternatingly.</p>  <p>Alternating flashing</p>	<p>Allow marks to pass through dynamically.</p> 	<p>Briefly press teach button.</p>  <p>Measurement window closes.</p>	<p>Sensor in RUN mode. Yellow LED is off.</p>  <p>Switching threshold is set near the mark.</p>
---	---	---	---	--	--



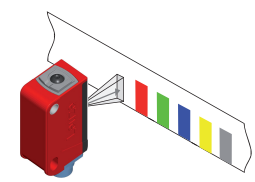

Static 1-point teach

Suitable for detecting all marks outside of the reference value (availability dependent on sensor type).

Standard sensitivity

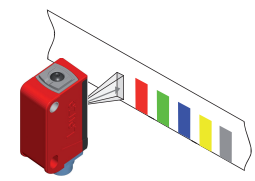
<p>Position the reference value.</p> 	<p>Press teach button for 2 ... 7s.</p> 	<p>LEDs flash simultaneously.</p>  <p>Simultaneous flashing</p>	<p>Release teach button.</p>  <p>Value is accepted.</p>	<p>Sensor in RUN mode. Yellow LED is off.</p>  <p>Standard sensitivity is set.</p>
--	---	---	---	---

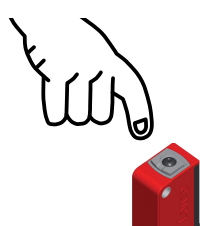
High sensitivity

<p>Position the reference value.</p> 	<p>Press teach button for 7 ... 12s.</p> 	<p>LEDs flash alternatingly.</p>  <p>Alternating flashing</p>	<p>Release teach button.</p>  <p>Value is accepted.</p>	<p>Sensor in RUN mode. Yellow LED is off.</p>  <p>High sensitivity is set.</p>
--	--	---	---	---

Switching threshold diagrams

Static 2-point teach

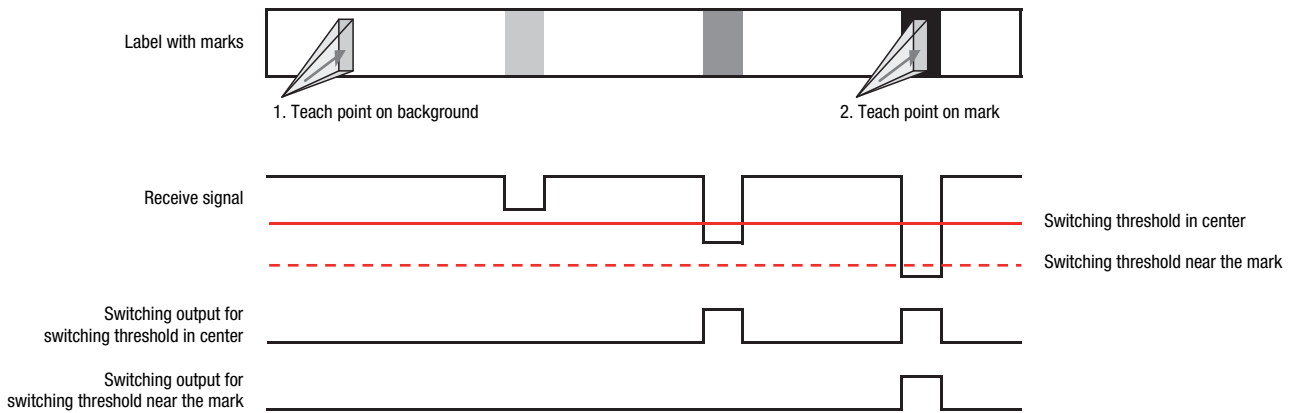

Dynamic 2-point teach

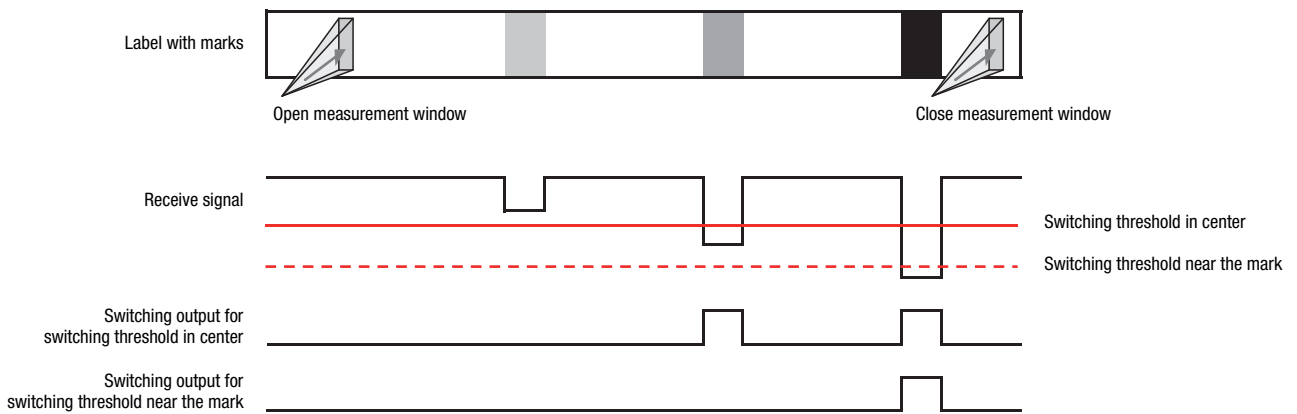

Static 1-point teach

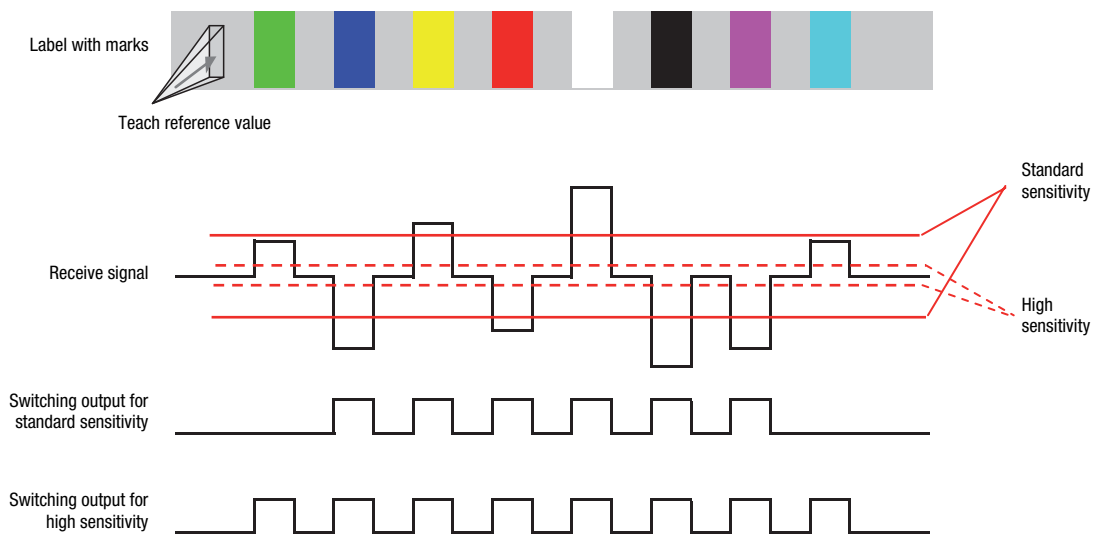



KRTW 3B

White light contrast scanner

Pulse stretching option

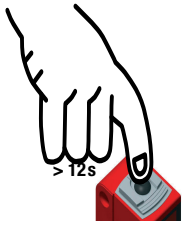
Switching pulse stretching on or off:

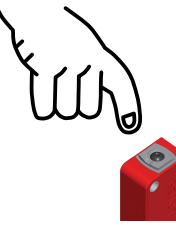
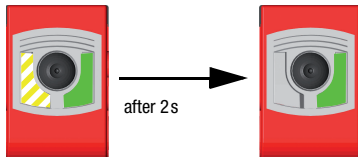
<p>Press the teach button longer than 12s.</p> 	<p>Only the green LED flashes.</p> 	<p>Release teach button.</p> 	<p>Change is displayed and accepted automatically after 2s. Sensor in RUN mode.</p>  <p>After 2s the yellow LED is back to normal operation, displaying the state of the switching output.</p> <p>After releasing the teach button, the yellow LED displays the new pulse stretching status for 2s: yellow LED on: pulse stretching ON yellow LED off: pulse stretching OFF</p>
--	--	--	---

"EasyTune" option - fine tuning of the switching threshold

Following power-on and completed teach event:

Green LED illuminates continuously (ready),
 Yellow LED on/off continuously (mark detected/not detected).

Increasing the switching threshold:

Long press of the button = large force expenditure = increase switching threshold

Each press of the button with a duration between 200ms and 2s increments the switching threshold.



200ms ... 2s



Green LED flashes briefly once

A press of the button is acknowledged by a single, brief flash of the green LED – the new switching threshold is now valid.

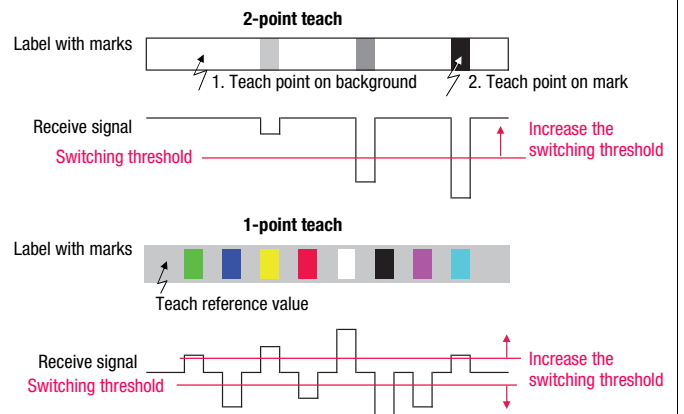

Reducing the switching threshold:

Short press of the button = small force expenditure = reduce switching threshold

Each press of the button with a duration between 2ms and 200ms decrements the switching threshold.

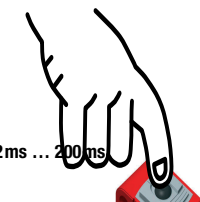

2ms ... 200ms



Green LED flashes briefly once

A press of the button is acknowledged by a single, brief flash of the green LED – the new switching threshold is now valid.

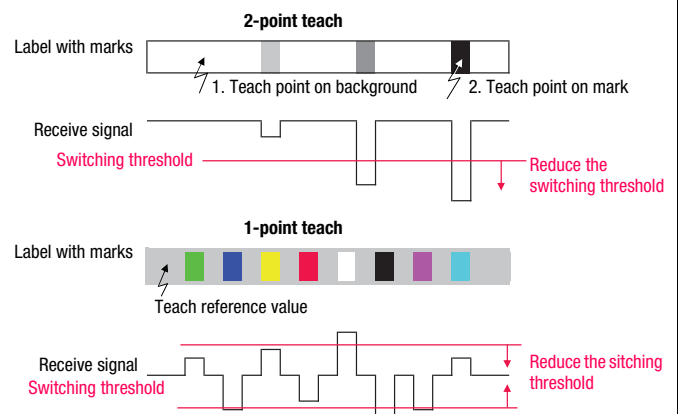

If the upper or lower end of the adjustment range is reached, the green and yellow LEDs flash at a considerably higher frequency of 8Hz for the duration of one second.

Sensor adjustments via the input IN (Pin 2)



The following description applies to PNP switching logic!

Signal level LOW $\leq 2V$

Signal level HIGH $\geq (U_B - 2V)$

With the NPN models, the signal levels are inverted!

Switching threshold in center / standard sensitivity

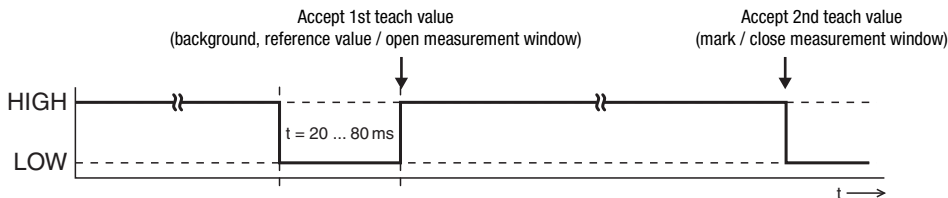

Switching threshold near the mark / high sensitivity

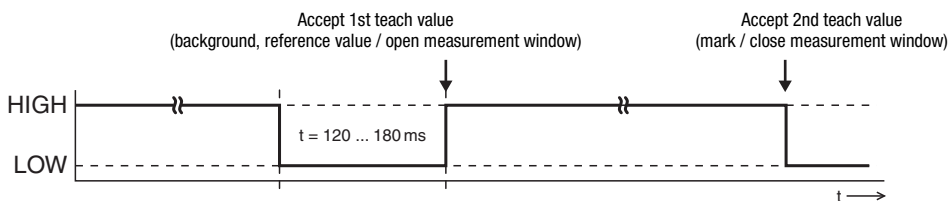

Pulse stretching ON

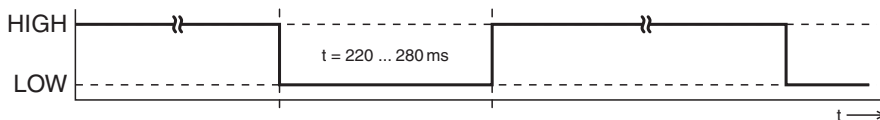

Pulse stretching OFF

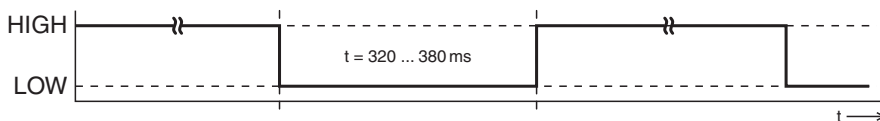

Locking the teach button via the input IN (Pin 2)



A static HIGH signal ($\geq 20ms$) at the teach input locks the teach button on the sensor if required, such that no manual operation is possible (e.g., protection from erroneous operation or manipulation).

If the teach input is not connected or if there is a static low signal, the button is unlocked and can be operated freely.

