

Technical data sheet Safety light curtain receiver

Part no.: 68042216

MLC520R20-1650-EX2



Contents

- Technical data
- Dimensioned drawings
- Electrical connection
- Circuit diagrams
- Operation and display
- Suitable transmitters
- Part number code
- Notes
- Accessories



Technical data

Basic data

| | |
|-------------|------------------------|
| Series | MLC 500 |
| Device type | Receiver |
| Contains | 2x BT-NC sliding block |
| Application | Hand protection |

Functions

| | |
|------------------|---|
| Function package | Standard |
| Functions | Contactormonitoring (EDM) Start/restart interlock (RES) Transmission channel changeover |

Characteristic parameters

| | |
|-----------------------------|--------------------------|
| Type | 4, IEC/EN 61496 |
| SIL | 3, IEC 61508 |
| SILCL | 3, IEC/EN 62061 |
| Performance Level (PL) | e, EN ISO 13849-1 |
| PFH _D | 7.73E-09 per hour |
| Mission time T _M | 20 years, EN ISO 13849-1 |
| Category | 4, EN ISO 13849 |

Protective field data

| | |
|-------------------------|----------|
| Resolution | 20 mm |
| Protective field height | 1,650 mm |

Optical data

| | |
|-----------------|--|
| Synchronization | Optical between transmitter and receiver |
|-----------------|--|

Electrical data

| | |
|--------------------|---|
| Protective circuit | Overvoltage protection Short circuit protected |
|--------------------|---|

Performance data

| | |
|-------------------------------|------------------------|
| Supply voltage U _B | 24 V, DC, -20 ... 20 % |
| Current consumption, max. | 150 mA |
| Fuse | 2 A semi time-lag |

Inputs

| | |
|------------------------------------|------------|
| Number of digital switching inputs | 3 Piece(s) |
|------------------------------------|------------|

Switching inputs

| | |
|------------------------------|-------------------------|
| Type | Digital switching input |
| Switching voltage high, min. | 18 V |
| Switching voltage low, max. | 2.5 V |
| Switching voltage, typ. | 22.5 V |
| Voltage type | DC |

Outputs

| | |
|--|------------|
| Number of safety-related switching outputs (OSSDs) | 2 Piece(s) |
|--|------------|

Safety-related switching outputs

| | |
|------------------------------|--------------------------------------|
| Type | Safety-related switching output OSSD |
| Switching voltage high, min. | 18 V |
| Switching voltage low, max. | 2.5 V |
| Switching voltage, typ. | 22.5 V |
| Voltage type | DC |
| Current load, max. | 380 mA |
| Load inductivity | 2,000 µH |
| Load capacity | 0.3 µF |
| Residual current, max. | 0.2 mA |
| Residual current, typ. | 0.002 mA |
| Voltage drop | 1.5 V |

Safety-related switching output 1

| | |
|-------------------|---------------------|
| Assignment | Connection 1, pin 5 |
| Switching element | Transistor, PNP |

Safety-related switching output 2

| | |
|-------------------|---------------------|
| Assignment | Connection 1, pin 6 |
| Switching element | Transistor, PNP |

Timing

| | |
|--------------------|--------|
| Response time | 29 ms |
| Restart delay time | 100 ms |

Connection

| | |
|-----------------------|------------|
| Number of connections | 1 Piece(s) |
|-----------------------|------------|

Connection 1

| | |
|--------------------|-------------------|
| Function | Machine interface |
| Type of connection | Connector |
| Thread size | M12 |
| Material | Metal |
| No. of pins | 8 -pin |

Cable properties

| | |
|--|----------------------|
| Permissible conductor cross section, typ. | 0.25 mm ² |
| Length of connection cable, max. | 100 m |
| Permissible cable resistance to load, max. | 200 Ω |

Mechanical data

| | |
|-----------------------|--|
| Dimension (W x H x L) | 29 mm x 1,716 mm x 35.4 mm |
| Housing material | Metal |
| Metal housing | Aluminum |
| Lens cover material | Plastic/PC |
| Material of end caps | Diecast zinc |
| Net weight | 1,800 g |
| Housing color | Silver |
| Type of fastening | Groove mounting Mounting bracket Mounting on Device Column Swivel mount |

Operation and display

| | |
|-----------------|--------------------------|
| Type of display | 7-segment display LED |
| Number of LEDs | 2 Piece(s) |

Technical data

Environmental data

| | |
|------------------------------------|---------------|
| Ambient temperature, operation | 0 ... 55 °C |
| Ambient temperature, storage | -30 ... 70 °C |
| Relative humidity (non-condensing) | 0 ... 95 % |

Ex specification

| | |
|---------------------------------|---------------------------------|
| Ex device category | 3D |
| | 3G |
| Ex-zone | 2 |
| | 22 |
| Ex device group | II |
| Permissible surface temperature | T<85° (T4) °C |
| Ignition protection type | "nA" non-sparking |
| | "tc" protection through housing |

Certifications

| | |
|----------------------|----------------------|
| Degree of protection | IP 65 |
| Protection class | III |
| Certifications | c TÜV NRTL US |
| | TÜV Süd |
| Vibration resistance | 50 m/s ² |
| Shock resistance | 100 m/s ² |
| US patents | US 6,418,546 B |

Classification

| | |
|-----------------------|----------|
| Customs tariff number | 85365019 |
| eCl@ss 5.1.4 | 27272704 |
| eCl@ss 8.0 | 27272704 |
| eCl@ss 9.0 | 27272704 |
| eCl@ss 10.0 | 27272704 |
| eCl@ss 11.0 | 27272704 |
| ETIM 5.0 | EC002549 |
| ETIM 6.0 | EC002549 |
| ETIM 7.0 | EC002549 |

Dimensioned drawings

All dimensions in millimeters

Calculation of the effective protective field height $H_{PFE} = H_{PFN} + B + C$

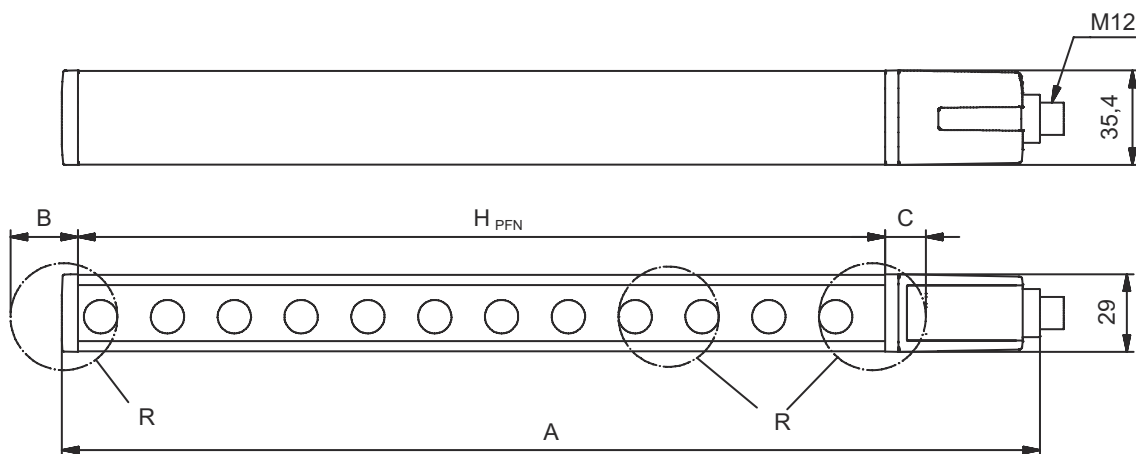

H_{PFE} Effective protective field height = 1667 mm
 H_{PFN} Nominal protective field height = 1650 mm
 A Total height = 1716 mm
 B 7 mm

C 10 mm
 R Effective protective field height H_{PFE} goes beyond the dimensions of the optics area to the outer borders of the circles labeled with R.

Electrical connection

Connection 1

| | |
|--------------------|-------------------|
| Function | Machine interface |
| Type of connection | Connector |
| Thread size | M12 |
| Type | Male |
| Material | Metal |
| No. of pins | 8 -pin |
| Encoding | A-coded |
| Connector housing | FE/SHIELD |

| Pin | Pin assignment | Conductor color |
|-----|----------------|-----------------|
| 1 | IO1 | White |
| 2 | VIN1 | Brown |
| 3 | IN3 | Green |
| 4 | IN4 | Yellow |
| 5 | OSSD1 | Gray |
| 6 | OSSD2 | Pink |
| 7 | VIN2 | Blue |
| 8 | IN8 | Red |



Circuit diagrams

Connection diagram receiver

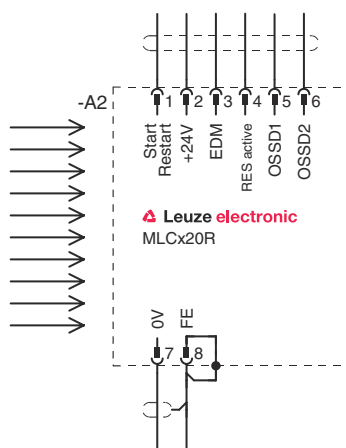

- VIN1 = +24 V, VIN2 = 0 V: transmission channel C1
- VIN1 = 0 V, VIN2 = +24 V: transmission channel C2

Circuit diagrams

Circuit diagram example with downstream MSI-RM2 safety relay

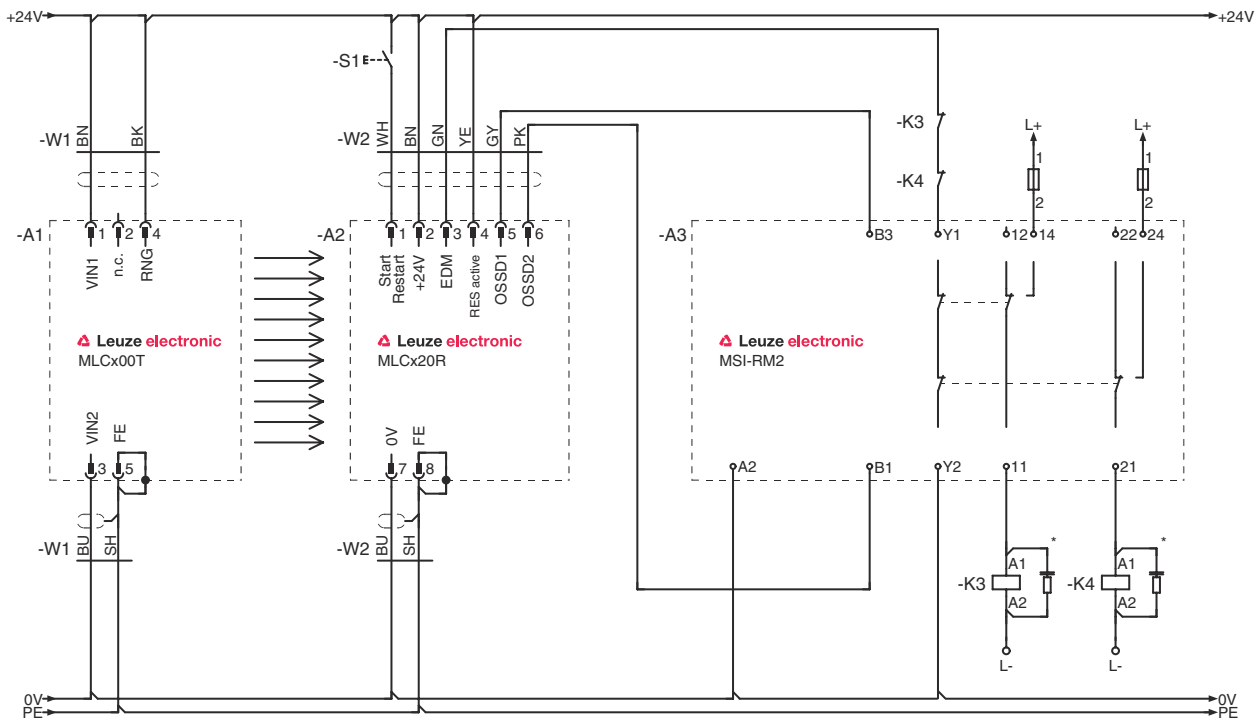

Operation and display

| LED | Display | Meaning |
|-----|--------------------------|---|
| 1 | Off | Device switched off |
| | Red, continuous light | OSSD off |
| | Red, flashing, 1 Hz | External error |
| | Red, flashing, 10 Hz | Internal error |
| | Green, flashing, 1 Hz | OSSD on, weak signal |
| | Green, continuous light | OSSD on |
| 2 | Off | RES deactivated or RES activated and enabled or RES blocked and protective field interrupted |
| | Yellow, continuous light | RES activated and blocked but ready to be unlocked - protective field free and linked sensor is enabled if applicable |

Suitable transmitters

| Part no. | Designation | Article | Description |
|----------|--------------------|----------------------------------|--|
| 68040216 | MLC500T20-1650-EX2 | Safety light curtain transmitter | Resolution: 20 mm Protective field height: 1,650 mm Operating range: 0 ... 15 m Connection: Connector, M12, Metal, 5 -pin |

Part number code

Part designation: MLCxyy-za-hhhhei-ooo

| | |
|-------------|---|
| MLC | Safety light curtain |
| x | Series 3: MLC 300 5: MLC 500 |
| yy | Function classes 00: transmitter 01: transmitter (AIDA) 02: transmitter with test input 10: basic receiver - automatic restart 11: basic receiver - automatic restart (AIDA) 20: standard receiver - EDM/RES selectable 30: extended receiver - blanking/muting |
| z | Device type T: transmitter R: receiver |
| a | Resolution 14: 14 mm 20: 20 mm 30: 30 mm 40: 40 mm 90: 90 mm |
| hhhh | Protective field height 150 ... 3000: from 150 mm to 3000 mm |
| e | Host/Guest (optional) H: Host MG: Middle Guest G: Guest |
| i | Interface (optional) /A: AS-i |
| ooo | Option /V: high Vibration-proof EX2: explosion protection (zones 2 + 22) SPG: Smart Process Gating |

Note

A list with all available device types can be found on the Leuze website at www.leuze.com.

Notes

Observe intended use!

↪ The product may only be put into operation by competent persons.
 ↪ Only use the product in accordance with its intended use.

Accessories



Connection technology - Connection cables

| | Part no. | Designation | Article | Description |
|---|----------|--------------------|------------------|--|
|  | 50135128 | KD S-M12-8A-P1-050 | Connection cable | Connection 1: Connector, M12, Axial, Female, A-coded, 8 -pin Connection 2: Open end Shielded: Yes Cable length: 5,000 mm Sheathing material: PUR |

Mounting technology - Swivel mounts

| | Part no. | Designation | Article | Description |
|--|----------|-------------|----------------------|---|
|  | 429393 | BT-2HF | Mounting bracket set | Fastening, at system: Through-hole mounting Mounting bracket, at device: Clampable Type of mounting device: Turning, 360° Material: Metal, Plastic |

Services

| | Part no. | Designation | Article | Description |
|--|----------|-------------|--|--|
|  | S981050 | CS40-I-140 | Safety inspection "Safety light barriers" | Details: Checking of a safety light barrier application in accordance with current standards and guidelines. Inclusion of the device and machine data in a database, production of a test log per application. Conditions: It must be possible to stop the machine, support provided by customer's employees and access to the machine for Leuze employees must be ensured. Restrictions: Travel costs and accommodation expenses charged separately and according to expenditure. |
|  | S981046 | CS40-S-140 | Start-up support | Details: For safety devices including stopping time measurement and initial inspection. Conditions: Devices and connection cables are already mounted, price not including travel costs and, if applicable, accommodation expenses. Restrictions: Max. 2 h., no mechanical (mounting) and electrical (wiring) work performed, no changes (attachments, wiring, programming) to third-party components in the nearby environment. |

Note



A list with all available accessories can be found on the Leuze website in the Download tab of the article detailed page.