



BCL 338i Bar code readers



© 2017

Leuze electronic GmbH + Co. KG

In der Braike 1

D-73277 Owen / Germany

Phone: +49 7021 573-0

Fax: +49 7021 573-199

<http://www.leuze.com>

info@leuze.com

1	General information	10
1.1	Explanation of symbols.....	10
1.2	Declaration of Conformity.....	10
2	Safety	11
2.1	Intended use.....	11
2.2	Foreseeable misuse.....	11
2.3	Competent persons	12
2.4	Exemption of liability.....	12
2.5	Laser safety notices	13
3	Fast commissioning / operating principle	16
3.1	Mounting the BCL 338 <i>i</i>	16
3.2	Device arrangement and selection of the mounting location.....	16
3.3	BCL 338 <i>i</i> electrical connection.....	17
3.4	BCL 338 <i>i</i> on the EtherCAT	22
3.5	Further settings.....	23
3.6	Starting the device.....	24
3.7	Bar code reading.....	26
4	Device description	27
4.1	About the bar code readers of the BCL 300 <i>i</i> series.....	27
4.2	Characteristics of the bar code readers of the BCL 300 <i>i</i> series.....	28
4.3	Device construction.....	30
4.4	Reading techniques.....	33
4.4.1	Line scanner (single line).....	33
4.4.2	Line scanner with oscillating mirror.....	34
4.4.3	Raster scanner (raster line)	35
4.5	Fieldbus systems.....	36
4.5.1	EtherCAT	36
4.6	Heating.....	37
4.7	autoReflAct.....	37
4.8	Reference codes	38
4.9	autoConfig.....	38

5	Technical data	39
5.1	General specifications of the bar code readers	39
5.1.1	Line scanner / raster scanner.....	39
5.1.2	Oscillating-mirror scanner	41
5.1.3	Line / raster scanner with deflecting mirror	41
5.2	Heating models of the bar code readers	42
5.2.1	Line scanner / raster scanner with heating.....	43
5.2.2	Oscillating-mirror scanner with heating	43
5.2.3	Line scanner / raster scanner with deflecting mirror and heating.....	44
5.3	Dimensioned drawings	45
5.3.1	Dimensioned drawing of complete overview of the BCL 338 <i>i</i> with MS 3xx / MK 3xx / ME 3xx.....	45
5.3.2	Dimensioned drawing of line scanner with / without heating	46
5.3.3	Dimensioned drawing of deflecting mirror scanner with / without heating.....	47
5.3.4	Dimensioned drawing of oscillating-mirror scanner with / without heating	48
5.3.5	Dimensioned drawings of MS 3xx / ME 3xx / MK 3xx connection hoods.....	49
5.4	Reading field curves / optical data	51
5.4.1	Bar code characteristics.....	51
5.4.2	Raster scanner	52
5.5	Reading field curves	53
5.5.1	High Density (N) - optics: BCL 338 <i>i</i> S/R1 N 102 (H).....	54
5.5.2	High Density (N) - optics: BCL 338 <i>i</i> S/R1 N 100 (H).....	54
5.5.3	Medium Density (M) - optics: BCL 338 <i>i</i> S/R1 M 102 (H).....	55
5.5.4	Medium Density (M) - optics: BCL 338 <i>i</i> S/R1 M 100 (H).....	55
5.5.5	Medium Density (M) - optics: BCL 338 <i>i</i> O M 100 (H).....	56
5.5.6	Low Density (F) - optics: BCL 338 <i>i</i> S/R1 F 102 (H)	57
5.5.7	Low Density (F) - optics: BCL 338 <i>i</i> S/R1 F 100 (H)	57
5.5.8	Low Density (F) - optics: BCL 338 <i>i</i> O F 100 (H).....	58
5.5.9	Ultra Low Density (L) - optics: BCL 338 <i>i</i> S L 102 (H)	59
5.5.10	Ultra Low Density (L) - optics: BCL 338 <i>i</i> S L 100 (H).....	59
5.5.11	Ultra Low Density (L) - optics: BCL 338 <i>i</i> O L 100 (H)	60
5.5.12	Ink Jet (J) - optics: BCL 338 <i>i</i> R1 J 100.....	61
6	Installation and mounting	62
6.1	Storage, transportation	62
6.2	Mounting the BCL 338<i>i</i>	63
6.2.1	Mounting via M4 x 5 screws.....	63
6.2.2	BT 56 mounting device	64
6.2.3	BT 59 mounting device	66
6.2.4	BT 300 - 1, BT 300 W mounting devices.....	67

6.3	Device arrangement.....	68
6.3.1	Selecting a mounting location.....	68
6.3.2	Avoiding total reflection – Line scanner.....	69
6.3.3	Avoiding total reflection – deflecting mirror scanner.....	69
6.3.4	Avoiding total reflection – oscillating-mirror scanner.....	70
6.3.5	Mounting location.....	70
6.3.6	Devices with integrated heating.....	71
6.3.7	Possible read angles between BCL 338 <i>i</i> and bar code.....	71
6.4	Cleaning.....	72
7	Electrical connection.....	73
7.1	Safety notices for the electrical connection.....	74
7.2	BCL 338<i>i</i> electrical connection.....	75
7.2.1	MS 338 connector hood with 3 integrated M12 connectors.....	75
7.2.2	ME 338 103 connection hood with M12 connection cables.....	76
7.2.3	ME 338 104 connection hood with M8/M12 connection cables.....	78
7.2.4	ME 338 214 connection hood with M8/M12/RJ45 connection cables.....	79
7.2.5	MK 338 terminal hood with spring-cage terminals.....	80
7.3	Detailed description of the connections.....	82
7.3.1	PWR / SW IN/OUT - Voltage supply and switching input/output 1 and 2.....	82
7.3.2	SENSOR - direct connection of an external sensor (ME 338 xx4 only).....	84
7.3.3	SERVICE – USB interface (Mini-B type).....	85
7.3.4	HOST / BUS IN for BCL 338 <i>i</i>	86
7.3.5	BUS OUT for the BCL 338 <i>i</i>	88
7.4	EtherCAT topologies.....	89
7.4.1	EtherCAT wiring.....	90
7.5	Cable lengths and shielding.....	91
8	Display elements and display.....	92
8.1	BCL 338<i>i</i> LED indicators.....	92
8.2	MS 338/ME 338.../MK338 LED indicators.....	95
8.3	BCL 338<i>i</i> display.....	97
9	Leuze webConfig tool.....	99
9.1	Connecting the SERVICE USB interface.....	99
9.2	Installing the required software.....	100
9.2.1	System requirements.....	100
9.2.2	Installing the USB driver.....	100
9.3	Starting the webConfig tool.....	101

9.4	Short description of the webConfig tool	102
9.4.1	Module overview in the Configuration menu	102
10	Commissioning and configuration	104
10.1	Measures to be performed prior to the initial commissioning	104
10.2	Starting the device.....	104
10.3	Additional settings for the BCL 338<i>i</i>.....	105
10.3.1	Decoding and processing the read data	105
10.3.2	Control of the decoding	107
10.3.3	Control of the switching outputs	108
10.4	Transmitting configuration data.....	109
10.4.1	Via the webConfig tool	109
10.4.2	Replacing a defective BCL 338 <i>i</i>	109
11	BCL 338<i>i</i> in the EtherCAT system.....	110
11.1	Ethernet over EtherCAT - EoE.....	110
11.2	CANopen over EtherCAT - CoE.....	111
11.3	Starting the BCL 338<i>i</i> in the EtherCAT system	112
11.4	Device profile	113
11.4.1	Device description file	113
11.4.2	Object directory overview	115
11.4.3	Communication objects.....	116
11.4.3.1	Object 1000 _h Device type.....	116
11.4.3.2	Object 1008 _h Manufacturer Device Name.....	116
11.4.3.3	Object 1009 _h Manufacturer Hardware Version.....	116
11.4.3.4	Object 100A _h Manufacturer Software Version.....	116
11.4.3.5	Object 1018 _h Identity Object.....	117
11.4.3.6	Objects 1600 _h ... 1607 _h – general mapping	118
11.4.3.7	Object 1600 _h 1st Receive PDO Mapping RxPDO1 (Submission data, 8 bytes)	119
11.4.3.8	Object 1601 _h 2nd Receive PDO Mapping RxPDO2 (Submission data, 16 bytes)	119
11.4.3.9	Object 1602 _h 3rd Receive PDO Mapping RxPDO3 (Submission data, 32 bytes)	120
11.4.3.10	Object 1603 _h 4th Receive PDO Mapping RxPDO4 (Submission data, 48 bytes)	121
11.4.3.11	Object 1604 _h 5th Receive PDO Mapping RxPDO5 (Submission data, 64 bytes)	122
11.4.3.12	Object 1605 _h 6th Receive PDO Mapping RxPDO6 (Submission data, 96 bytes)	123
11.4.3.13	Object 1606 _h 7th Receive PDO Mapping RxPDO7 (Submission data, 128 bytes)	124
11.4.3.14	Object 1607 _h 8th Receive PDO Mapping RxPDO8 (Submission data, 252 bytes)	125
11.4.3.15	Objects 1A00 _h ... 1A07 _h – general mapping	126
11.4.3.16	Object 1A00 _h 1st Transmit PDO Mapping TxPDO1 (Result data, 8 bytes).....	128
11.4.3.17	Object 1A01 _h 2nd Transmit PDO Mapping TxPDO2 (Result data, 16 bytes).....	128
11.4.3.18	Object 1A02 _h 3rd Transmit PDO Mapping TxPDO3 (Result data, 32 bytes)	129
11.4.3.19	Object 1A03 _h 4th Transmit PDO Mapping TxPDO4 (Result data, 48 bytes).....	130
11.4.3.20	Object 1A04 _h 5th Transmit PDO Mapping TxPDO5 (Result data, 64 bytes).....	131
11.4.3.21	Object 1A05 _h 6th Transmit PDO Mapping TxPDO6 (Result data, 96 bytes).....	132

11.4.3.22	Object 1A06 _h , 7th Transmit PDO Mapping TxPDO7 (Result data, 128 bytes)	133
11.4.3.23	Object 1A07 _h , 8th Transmit PDO Mapping TxPDO8 (Result data, 252 bytes)	134
11.4.3.24	Object 1C00 _h , Sync Manager Communication Type	135
11.4.3.25	Object 1C12 _h , Sync Manager 2 PDO Assignment	136
11.4.3.26	Object 1C13 _h , Sync Manager 3 PDO Assignment	136
11.4.4	Device-specific objects	137
11.4.4.1	Objects 0x2000 _h to 0x2007 _h , Result data	137
11.4.4.2	Object 0x2050 _h , Status result data	138
11.4.4.3	Objects 0x2100 _h to 0x2107 _h , Submission data	140
11.4.4.4	Object 0x2150 _h , Status submission data	142
11.4.4.5	Object 0x2200 _h , Activation	144
11.4.4.6	Object 0x2300 _h , Fragmented result	146
11.4.4.7	Object 0x2400 _h , Fragmented submission	148
11.4.4.8	Object 0x2450 _h , Device status and control	150
11.5	Communication examples	151
11.5.1	Application case: Reading a bar code	151
11.5.2	Application case: Transmitting 'PT' sequences	153
12	Online commands	154
12.1	Overview of commands and parameters	154
12.1.1	General online commands	155
12.1.2	Online commands for system control	162
12.1.3	Online commands for configuring the switching inputs/outputs	163
12.1.4	Online commands for the parameter set operations	166
13	Diagnostics and troubleshooting	173
13.1	General causes of errors	173
13.2	Interface errors	173
14	Type overview and accessories	175
14.1	Part number code	175
14.2	BCL 338<i>i</i> type overview	176
14.3	Accessories - Connection hoods	177
14.4	Accessories – Connectors	177
14.5	Accessory USB cable	177
14.6	Accessories – Mounting device	177
14.7	Accessory - Reflector for AutoReflAct	177

14.8	Accessory - Ready-made cables for voltage supply	178
14.8.1	Contact assignment of PWR connection cable	178
14.8.2	Technical data of the cables for voltage supply	178
14.8.3	Order codes of the cables for voltage supply	178
14.9	Accessory - Ready-made cables for bus connection.....	178
14.9.1	General information.....	178
14.9.2	Contact assignment of M12 EtherCAT connection cable.....	179
14.9.3	Technical data for M12 EtherCAT connection cable.....	179
14.9.4	Order codes for M12 EtherCAT connection cable.....	180
15	Maintenance	181
15.1	General maintenance information.....	181
15.2	Repairs, servicing	181
15.3	Disassembling, packing, disposing	181
16	Appendix	182
16.1	Declarations of Conformity.....	182
16.2	ASCII character set.....	184
16.3	Bar code samples	188
16.3.1	Module 0.3	188
16.3.2	Module 0.5	189

Figure 2.1:	Laser apertures, laser warning signs	14
Figure 2.2:	Laser warning and information signs – supplied stick-on labels	15
Figure 3.1:	BCL 338 <i>i</i> - MS 338 connection hood with M12 connectors	17
Figure 3.2:	BCL 338 <i>i</i> - ME 338 103 connection hood with M12 connection cables.....	18
Figure 3.3:	BCL 338 <i>i</i> - ME 338 104 connection hood with M8/M12 connection cables.....	19
Figure 3.4:	BCL 338 <i>i</i> - ME 338 214 connection hood with M8/M12/RJ45 connection cables	20
Figure 3.5:	BCL 338 <i>i</i> - MK 338 terminal hood with spring-cage terminals.....	21
Figure 3.6:	Cable fabrication for MK 338 terminal hood.....	21
Figure 4.1:	Line scanner, line scanner with deflecting mirror and oscillating-mirror scanner.....	27
Figure 4.2:	Possible bar code orientation.....	29
Figure 4.3:	BCL 338 <i>i</i> device construction - line scanner.....	30
Figure 4.4:	Device construction BCL 338 <i>i</i> - Line scanner with deflecting mirror.....	30
Figure 4.5:	BCL 338 <i>i</i> device construction - oscillating-mirror scanner.....	31
Figure 4.6:	Device construction - MS 338 connector hood	31
Figure 4.7:	Device construction - MK 338 terminal hood	32
Figure 4.8:	Device construction - MS 338 103 / MS 338 104 connector hoods	32
Figure 4.9:	Deflection principle for the line scanner	33
Figure 4.10:	Deflection principle for the line scanner with oscillating mirror add-on	34
Figure 4.11:	Deflection principle for the raster scanner.....	35
Figure 4.13:	Reflector arrangement for autoRefIAct.....	37
Table 5.1:	Technical data of the BCL 338 <i>i</i> line/raster scanners without heating	39
Table 5.2:	Technical data of the BCL 338 <i>i</i> oscillating-mirror scanners with heating	41
Table 5.3:	Technical data of the BCL 338 <i>i</i> deflecting mirror scanners without heating	41
Table 5.4:	Technical data of the BCL 338 <i>i</i> line / raster scanners with heating	43
Table 5.5:	Specifications of the BCL 338 <i>i</i> oscillating-mirror scanners with heating.....	43
Table 5.6:	Technical data of the BCL 338 <i>i</i> deflecting mirror scanners with heating	44
Figure 5.1:	Dimensioned drawing of complete overview of the BCL 338 <i>i</i> with MS 3xx / MK 3xx / ME 3xx	45
Figure 5.2:	Dimensioned drawing of BCL 338 <i>i</i> S...102 line scanner	46
Figure 5.3:	Dimensioned drawing of BCL 338 <i>i</i> S...100 with deflecting mirror	47
Figure 5.4:	Dimensioned drawing of BCL 338 <i>i</i> O...100 oscillating-mirror scanner	48
Figure 5.5:	Dimensioned drawing of MS 3xx connector hood / ME 3xx connection hood	49
Figure 5.6:	Dimensioned drawing of MK 3xx terminal hood.....	50
Figure 5.7:	The most important characteristics of a bar code	51
Table 5.7:	Raster line cover dependent on the distance.....	52
Figure 5.8:	Zero position of the reading distance.....	53
Table 5.8:	Reading conditions	53
Figure 5.9:	"High Density" reading field curve for line scanner without deflecting mirror	54
Figure 5.10:	"High Density" reading field curve for line scanner with deflecting mirror	54
Figure 5.11:	"Medium Density" reading field curve for line scanner without deflecting mirror.....	55
Figure 5.12:	"Medium Density" reading field curve for line scanner with deflecting mirror.....	55
Figure 5.13:	"Medium Density" reading field curve for oscillating-mirror scanners	56
Figure 5.14:	Lateral "Medium Density" reading field curve for oscillating-mirror scanners	56

Figure 5.15:	"Low Density" reading field curve for line scanner without deflecting mirror	57
Figure 5.16:	"Low Density" reading field curve for line scanner with deflecting mirror	57
Figure 5.17:	"Low Density" reading field curve for oscillating-mirror scanners	58
Figure 5.18:	Lateral "Low Density" reading field curve for oscillating-mirror scanners	58
Figure 5.19:	"Ultra Low Density" reading field curve for line scanner without deflecting mirror	59
Figure 5.20:	"Ultra Low Density" reading field curve for line scanner with deflecting mirror	59
Figure 5.21:	"Ultra Low Density" reading field curve for oscillating-mirror scanners	60
Figure 5.22:	Lateral "Ultra Low Density" reading field curve for oscillating-mirror scanners	60
Figure 5.23:	"Ink Jet" reading field curve for line scanner with deflecting mirror	61
Figure 6.1:	Device name plate BCL 338 <i>i</i>	62
Figure 6.2:	Fastening options using M4x5 threaded holes	63
Figure 6.3:	BT 56 mounting device	64
Figure 6.4:	Mounting example of BCL 338 <i>i</i> with BT 56	65
Figure 6.5:	BT 59 mounting device	66
Figure 6.6:	BT 300 - 1, BT 300 W mounting devices	67
Figure 6.7:	Total reflection – line scanner	69
Figure 6.8:	Total reflection – line scanner	69
Figure 6.9:	Total reflection – BCL 338 <i>i</i> with oscillating-mirror scanner	70
Figure 6.10:	Reading angle for the line scanner	71
Figure 7.1:	Location of the electrical connections	73
Figure 7.2:	BCL 338 <i>i</i> - MS 338 connection hood with M12 connectors	75
Figure 7.3:	BCL 338 <i>i</i> - ME 338 103 connection hood with M12 connection cables	76
Figure 7.4:	BCL 338 <i>i</i> - ME 338 104 connection hood with M8/M12 connection cables	78
Figure 7.5:	BCL 338 <i>i</i> - ME 338 214 connection hood with M8/M12/RJ45 connection cables	79
Figure 7.6:	BCL 338 <i>i</i> - MK 338 terminal hood with spring-cage terminals	80
Figure 7.7:	Cable fabrication for MK 338 terminal hood	81
Table 7.1:	PWR / SW IN/OUT pin assignment	82
Figure 7.1:	Switching input connection diagram SWIO_1 and SWIO_2	83
Figure 7.2:	Switching output connection diagram SWIO_1 / SWIO_2	84
Table 7.2:	SENSOR pin assignment	84
Table 7.3:	SERVICE pin assignment – Mini-B type USB interface	85
Table 7.4:	Pin assignment HOST / BUS IN for BCL 338 <i>i</i>	86
Figure 7.1:	HOST / BUS IN cable assignments on RJ-45	87
Table 7.5:	Pin assignment BUS OUT for BCL 338 <i>i</i>	88
Figure 7.3:	EtherCAT in a linear topology	89
Table 7.6:	Cable lengths and shielding	91
Figure 8.1:	BCL 338 <i>i</i> - LED indicators	92
Figure 8.2:	MS 338/ME 338.../MK 338 - LED indicators	95
Figure 8.3:	BCL 338 <i>i</i> - Display	97
Figure 9.1:	Connecting the SERVICE USB interface	99
Figure 9.2:	The start page of the webConfig tool	101
Figure 9.3:	Module overview in the webConfig tool	102
Figure 10.1:	Storing configuration data in the webConfig tool	109

Figure 11.1:	Configuration options	114
Figure 11.2:	Sequence diagram for data acceptance/data rejection.....	141
Figure 11.3:	Sequence diagram for reading a bar code.....	152
Figure 11.4:	Sequence diagram for configuring with 'PT' sequences	153
Table 13.1:	General causes of errors.....	173
Table 13.2:	Interface error	173
Table 14.2:	BCL 358 <i>i</i> type overview	176
Table 14.3:	Connection hoods for the BCL 338 <i>i</i>	177
Table 14.4:	Connectors for the BCL 338 <i>i</i>	177
Table 14.5:	Service cable for the BCL 338 <i>i</i>	177
Table 14.6:	Mounting devices for the BCL 338 <i>i</i>	177
Table 14.7:	Reflector for autoReflAct operation.....	177
Table 14.8:	PWR cable for the BCL 338 <i>i</i>	178
Figure 14.1:	Cable construction of EtherNet/IP connection cable.....	179
Table 14.9:	Bus connection cables for the BCL 338 <i>i</i>	180
Figure 16.1:	BCL 338 <i>i</i> Declaration of Conformity.....	182
Figure 16.2:	Connection hood / connection unit declaration of conformity.....	183
Figure 16.3:	Bar code sample labels (module 0.3).....	188
Figure 16.4:	Bar code sample labels (module 0.5).....	189

1 General information

1.1 Explanation of symbols

The symbols used in this technical description are explained below.



Attention!

This symbol precedes text messages which must strictly be observed. Failure to observe the provided instructions could lead to personal injury or damage to equipment.



Attention Laser!

This symbol warns of possible danger through hazardous laser radiation.



Note!

This symbol indicates text passages containing important information.

1.2 Declaration of Conformity

The bar code readers of the BCL 300*i* series have been developed and manufactured in accordance with the applicable European standards and directives.



Note!

You can find the Declaration of Conformity of the devices in the appendix of the manual on Page 182.

The manufacturer of the product, Leuze electronic GmbH & Co. KG in D-73277 Owen, possesses a certified quality assurance system in accordance with ISO 9001.



2 Safety

The bar code readers of the BCL 3xx*i* series were developed, manufactured and tested in accordance with the applicable safety standards. They correspond to the state of the art.

2.1 Intended use

Bar code readers of the BCL 3xx*i* series are conceived as stationary, high-speed scanners with integrated decoders for all current bar codes used for automatic object detection.

Areas of application

The bar code readers of the BCL 3xx*i* series are especially designed for the following areas of application:

- Storage and conveying technologies, in particular for object identification on fast-moving conveyor belts
- Pallet transport systems
- Automobile sector
- Omnidirectional reading



CAUTION

Observe intended use!

⚠ Only operate the device in accordance with its intended use. The protection of personnel and the device cannot be guaranteed if the device is operated in a manner not complying with its intended use.

Leuze electronic GmbH + Co. KG is not liable for damages caused by improper use.

⚠ Read the technical description before commissioning the device. Knowledge of this technical description is an element of proper use.

NOTE

Comply with conditions and regulations!

⚠ Observe the locally applicable legal regulations and the rules of the employer's liability insurance association.



Attention

For UL applications, use is only permitted in Class 2 circuits in accordance with the NEC (National Electric Code).

2.2 Foreseeable misuse

Any use other than that defined under "Intended use" or which goes beyond that use is considered improper use.

In particular, use of the device is not permitted in the following cases:

- in rooms with explosive atmospheres
- as stand-alone safety component in accordance with the machinery directive ¹⁾
- for medical purposes

NOTE**Do not modify or otherwise interfere with the device!**

- ↳ Do not carry out modifications or otherwise interfere with the device.
The device must not be tampered with and must not be changed in any way.
The device must not be opened. There are no user-serviceable parts inside.
Repairs must only be performed by Leuze electronic GmbH + Co. KG.

2.3 Competent persons

Connection, mounting, commissioning and adjustment of the device must only be carried out by competent persons.

Prerequisites for competent persons:

- They have a suitable technical education.
- They are familiar with the rules and regulations for occupational safety and safety at work.
- They are familiar with the technical description of the device.
- They have been instructed by the responsible person on the mounting and operation of the device.

Certified electricians

Electrical work must be carried out by a certified electrician.

Due to their technical training, knowledge and experience as well as their familiarity with relevant standards and regulations, certified electricians are able to perform work on electrical systems and independently detect possible dangers.

In Germany, certified electricians must fulfill the requirements of accident-prevention regulations BGV A3 (e.g. electrician foreman). In other countries, there are respective regulations that must be observed.

2.4 Exemption of liability

Leuze electronic GmbH + Co. KG is not liable in the following cases:

- The device is not being used properly.
- Reasonably foreseeable misuse is not taken into account.
- Mounting and electrical connection are not properly performed.
- Changes (e.g., constructional) are made to the device.

¹⁾ Use as safety-related component within the safety function is possible, if the component combination is designed correspondingly by the machine manufacturer.

2.5 Laser safety notices



ATTENTION, LASER RADIATION – LASER CLASS 2

Never look directly into the beam!

The device satisfies the requirements of IEC 60825-1:2007 (EN 60825-1:2007) safety regulations for a product of **laser class 2** as well as the U.S. 21 CFR 1040.10 regulations with deviations corresponding to "Laser Notice No. 50" from June 24, 2007.

- ⚠ Never look directly into the laser beam or in the direction of reflected laser beams!
If you look into the beam path over a longer time period, there is a risk of injury to the retina.
- ⚠ Do not point the laser beam of the device at persons!
- ⚠ Interrupt the laser beam using a non-transparent, non-reflective object if the laser beam is accidentally directed towards a person.
- ⚠ When mounting and aligning the device, avoid reflections of the laser beam off reflective surfaces!
- ⚠ CAUTION! The use of operating or adjusting devices other than those specified here or carrying out of differing procedures may lead to dangerous exposure to radiation.
- ⚠ Observe the applicable statutory and local laser protection regulations.
- ⚠ The device must not be tampered with and must not be changed in any way.
There are no user-serviceable parts inside the device.
Repairs must only be performed by Leuze electronic GmbH + Co. KG.

NOTE

Affix laser information and warning signs!

Laser warning and laser information signs are affixed to the device (see Figure 2.1):

In addition, self-adhesive laser warning and information signs (stick-on labels) are supplied in several languages (see Figure 2.2).

- ⚠ Affix the laser information sheet to the device in the language appropriate for the place of use.
When using the device in the U.S.A., use the stick-on label with the "Complies with 21 CFR 1040.10" notice.
- ⚠ Affix the laser information and warning signs near the device if no signs are attached to the device (e.g., because the device is too small) or if the attached laser information and warning signs are concealed due to the installation position.
Affix the laser information and warning signs so that they are legible without exposing the reader to the laser radiation of the device or other optical radiation.

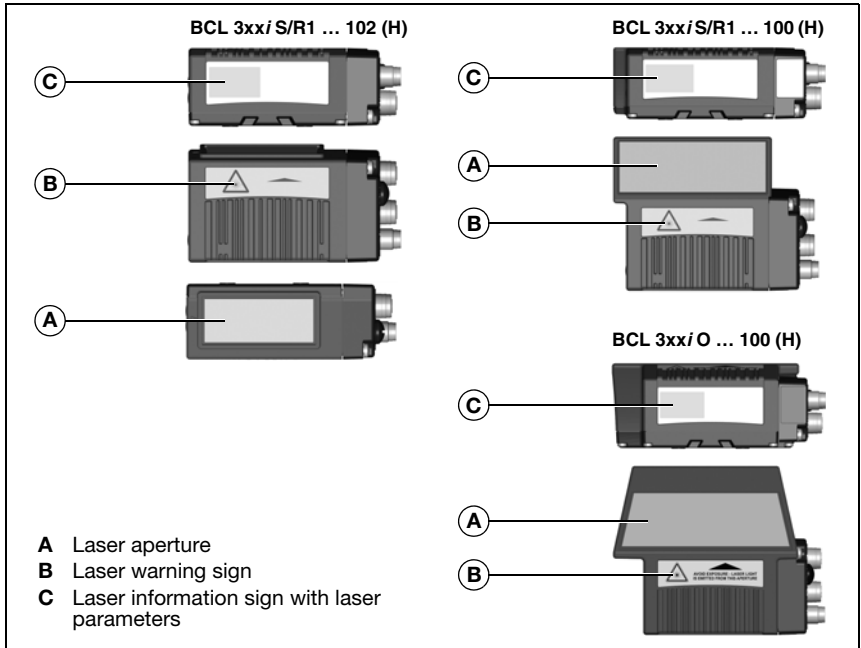


Figure 2.1: Laser apertures, laser warning signs

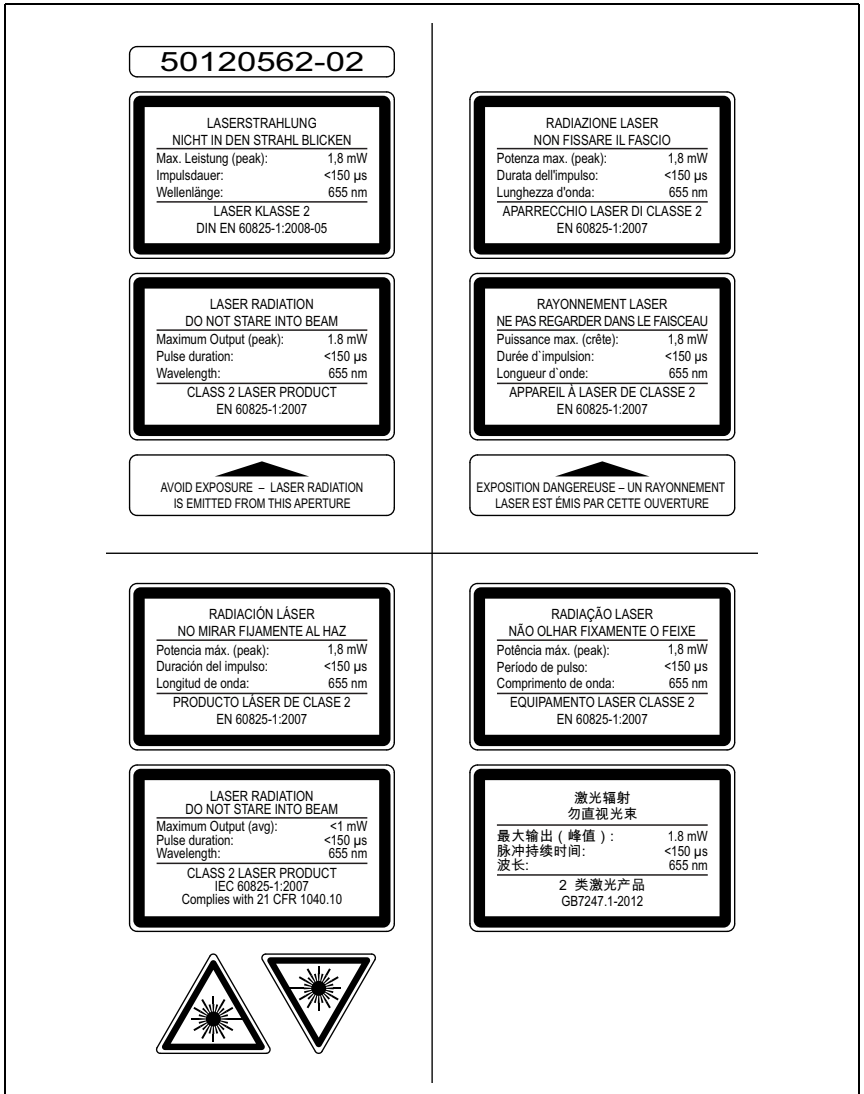


Figure 2.2: Laser warning and information signs – supplied stick-on labels

3 Fast commissioning / operating principle

Below you will find a short description for the initial commissioning of the BCL 338*i*. Detailed explanations for all listed points can be found throughout this technical description.

3.1 Mounting the BCL 338*i*

The BCL 338*i* bar code readers can be mounted in two different ways:

- Via four M4x6 screws on the device bottom.
- Via a BT 56 mounting device in the fastening groove on the housing bottom.

3.2 Device arrangement and selection of the mounting location

In order to select the right mounting location, several factors must be considered:

- Size, orientation, and position tolerance of the bar codes on the objects to be scanned.
- The reading field of the BCL 338*i* in relation to the bar code module width.
- The resulting minimum and maximum reading distance from the respective reading field.
- The permissible cable lengths between the BCL 338*i* and the host system depending on which interface is used.
- The correct time for data output. The BCL 338*i* should be positioned in such a way that, taking into consideration the time required for data processing and the conveyor belt speed, there is sufficient time to e.g. initiate sorting operations on the basis of the read data.
- The display and control panel should be very visible and accessible.
- For configuring and commissioning with the webConfig tool, the USB interface should be easily accessible.

For specific information, please refer to Chapter 6 and Chapter 7.



Note!

*The beam exits the BCL 338*i* as follows for the respective devices:*

- line scanner **parallel** to the **housing base**
- deflecting mirror **105 degrees** to the **housing base**
- oscillating mirror **perpendicular** to the **housing base**.

The black areas in Figure 6.2 are the housing base. The best read results are obtained when:

- *The BCL 338*i* is mounted in such a way that the scanning beam is incident on the bar code at an angle of inclination greater than $\pm 10^\circ$... 15° to vertical.*
- *The reading distance lies in the middle area of the reading field.*
- *The bar code labels are of good print quality and have good contrast ratios.*
- *You do not use high-gloss labels.*
- *There is no direct sunlight.*

3.3 BCL 338i electrical connection

For the electrical connection of the BCL 338i, various connection variants are available.

The **voltage supply** (18 ... 30VDC) is connected acc. to the connection type selected.

2 freely programmable switching inputs/outputs for individual adaptation to the respective application are also available here. Detailed information on this topic can be found in Chapter 7.3.4.

MS 338 connector hood with 2 integrated M12 connectors

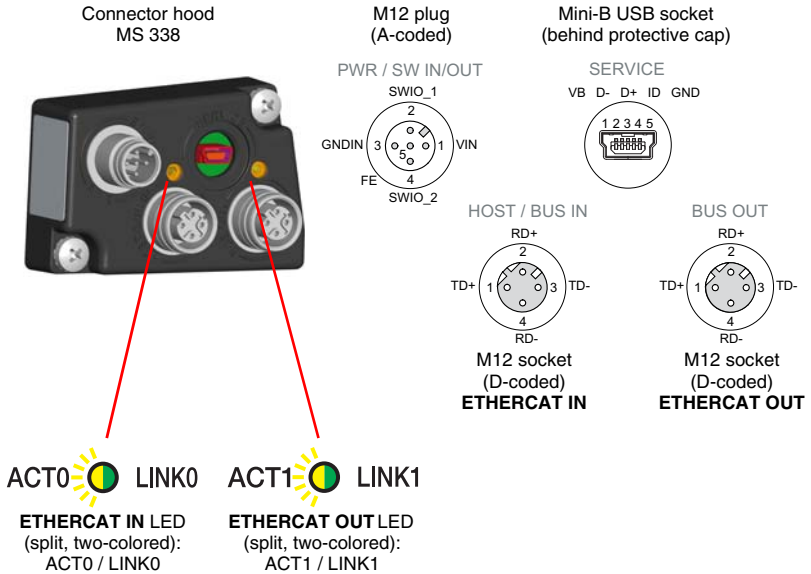


Figure 3.1: BCL 338i - MS 338 connection hood with M12 connectors



Note!

The shielding connection is done via the M12 connector housing.



Note!

The integrated parameter memory for the simple replacement of the BCL 338i is located in the MS 338. In the integrated parameter memory, both the settings and the network address are saved and transmitted to a new device.



Note!

In the case of EtherCAT line topology, the network is interrupted when the BCL 338i is removed from the MS 338.

ME 338 103 connection hood with M12 connection cables

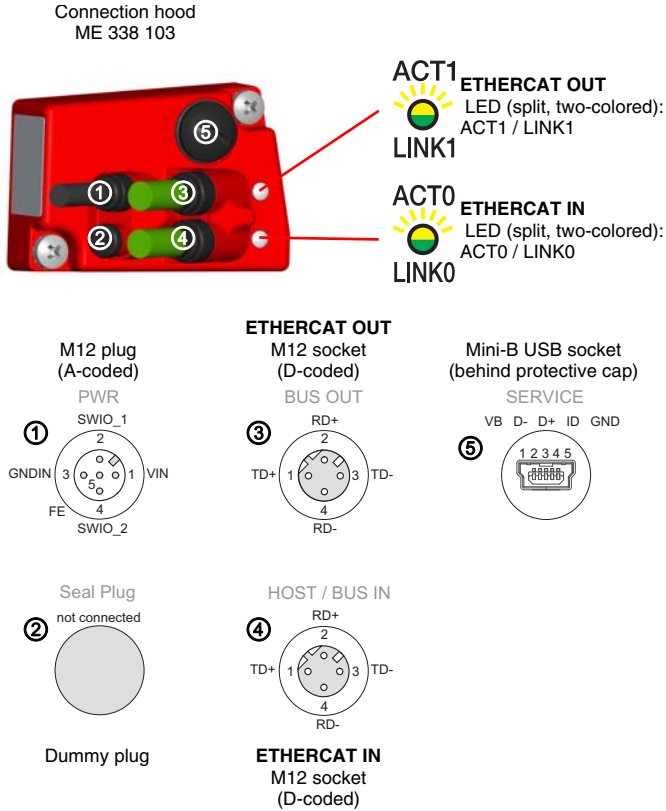


Figure 3.2: BCL 338i - ME 338 103 connection hood with M12 connection cables



Note!

The shielding connection is done via the M12 connector housing.



Note!

The integrated parameter memory for the simple replacement of the BCL 338i is located in the ME 338 103. In the integrated parameter memory, both the settings and the network address are saved and transmitted to a new device.



Note!

In the case of EtherCAT line topology, the network is interrupted when the BCL 338i is removed from the ME 338 103.

ME 338 104 connection hood with M8/M12 connection cables

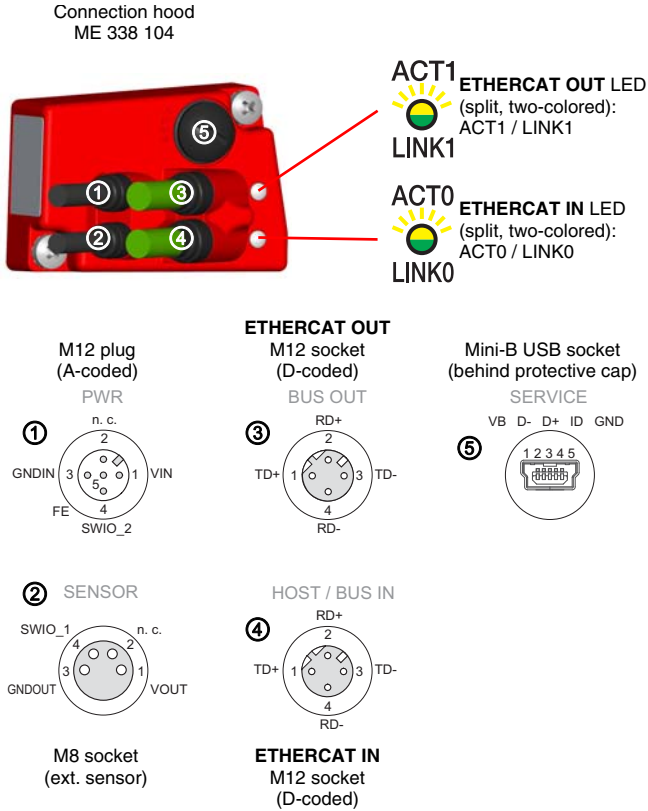


Figure 3.3: BCL 338i - ME 338 104 connection hood with M8/M12 connection cables



Note!

The shielding connection is done via the M12 connector housing.



Note!

The integrated parameter memory for the simple replacement of the BCL 338i is located in the ME 338 104. In the integrated parameter memory, both the settings and the network address are saved and transmitted to a new device.



Note!

In the case of EtherCAT line topology, the network is interrupted when the BCL 338i is removed from the ME 338 104.

ME 338 214 connection hood with M8/M12/RJ45 connection cables

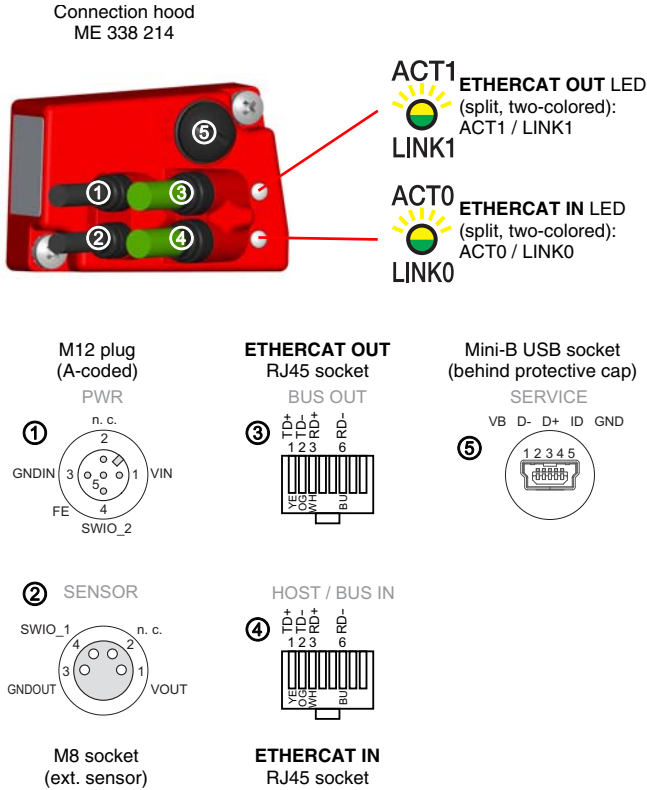


Figure 3.4: BCL 338i - ME 338 214 connection hood with M8/M12/RJ45 connection cables



Note!

The shielding connection is done via the M12 connector housing.



Note!

The integrated parameter memory for the simple replacement of the BCL 338i is located in the ME338 214. In the integrated parameter memory, both the settings and the network address are saved and transmitted to a new device.



Note!

In the case of EtherCAT line topology, the network is interrupted when the BCL 338i is removed from the ME 338 214.

MK 338 terminal hood with spring-cage terminals

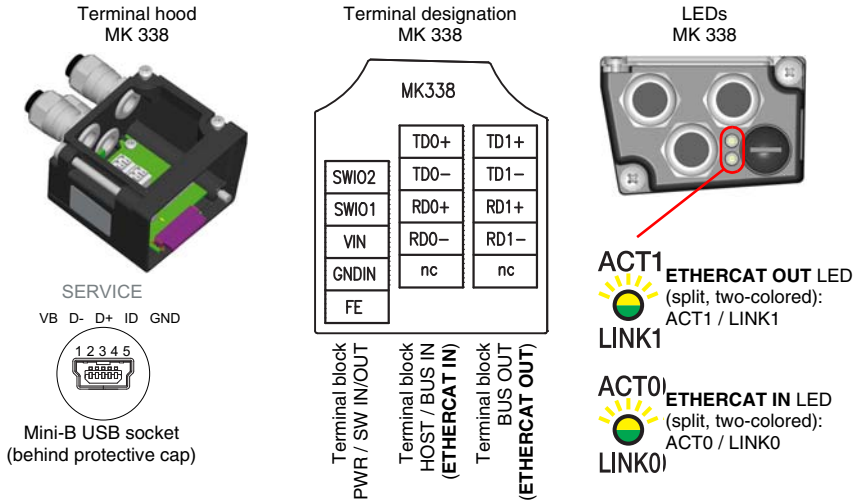


Figure 3.5: BCL 338i - MK 338 terminal hood with spring-cage terminals



Note!

The integrated parameter memory for the simple replacement of the BCL 338i is located in the MK 338. In the integrated parameter memory, both the settings and the network address are saved and transmitted to a new device.



Note!

In the case of EtherCAT line topology, the network is interrupted when the BCL 338i is removed from the MK 338.

Cable fabrication and shielding connection

Remove approx. 78 mm of the connection cable sheathing. 15 mm of sheath of the shielded line must be freely accessible.

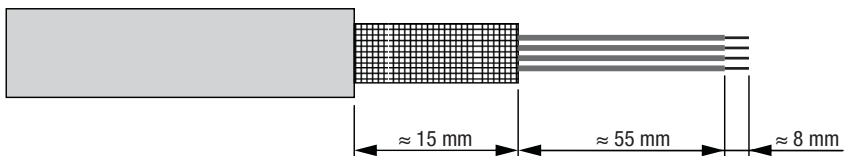


Figure 3.6: Cable fabrication for MK 338 terminal hood

The shield is automatically contacted when the cable is lead into the metal screw fitting and fastened when the cord grip is closed. Then lead the individual wires into the terminals according to the diagram. Wire end sleeves are not necessary.

3.4 BCL 338i on the EtherCAT

3.4.1 Device description file

For EtherCAT, all process data and parameters are described in objects. The compilation of all process data and parameters of the BCL 338i - the object directory - is stored in a so-called **ESI** file (EtherCAT Slave Information).

The **ESI** file contains all objects with index, sub-index, name, data type, default value, minimum and maximum, and access possibilities. That means the **ESI** file describes the entire functionality of the BCL 338i.

The ESI file has the name **BCL338i.xml** and is available for download on the Leuze home page.

Vendor ID for the BCL 338i

The Vendor ID assigned by Leuze electronic for the BCL 338i is $121_{\text{h}} = 289_{\text{d}}$.

Detailed information on the device description file and the object directory can be found in Chapter 10.

3.4.2 Device profile

The object designations and groupings of the generic device profile of the BCL 338i are based on common bar code reader profiles.

Detailed information can be found in Chapter 11.4.

3.4.3 Starting the BCL 338i in the EtherCAT system

As is common for EtherCAT, the BCL 338i runs through different states when starting up: "INIT", "PREOP", "SAFEOP" and "OPERATIONAL".

Detailed information can be found in Chapter 11.

3.5 Further settings

**Note!**

With the BCL 338i, the configuration of the device functionality is generally performed via the **webConfig tool** (see Chapter 9). EtherCAT is only used to set the bus-specific parameters for communication.

A special option for device configuration via EtherCAT is the transfer of "PT sequences". Information on this topic is only available on request.

After the basic configuration of the operating mode and the communication parameters, you need to carry out further settings:









- Decoding and processing the read data
 - ↳ Define at least one code type with the desired settings.
 - Via webConfig:
Configuration -> Decoder
- Control of the decoding
 - ↳ Configure the connected switching inputs according to your requirements. To do this, first set the I/O mode to *Input* and then configure the switching behavior:
 - Via webConfig:
Configuration > Device > Switching inputs/outputs
- Control of the switching outputs
 - ↳ Configure the connected switching outputs according to your requirements. To do this, first set the I/O mode to *Output* and then configure the switching behavior:
 - Via webConfig:
Configuration > Device > Switching inputs/outputs

3.6 Starting the device






↳ Connect the +18 ... 30VDC supply voltage (typ. +24VDC).




The BCL 338*i* starts up, the **PWR** and **NET** LEDs display the operating state. If there is a display, the bar code reading window appears in it.

PWR LED

PWR 	off	Device OFF, no supply voltage
PWR 	green, steady flashing	Device ok, initialization phase
PWR 	green, continuous light	Power On, device OK
PWR 	green, briefly off - on	Good read, successful reading
PWR 	green, briefly off - briefly red - on	No read, reading not successful
PWR 	orange, continuous light	Service mode
PWR 	red, flashing	Warning set
PWR 	red, continuous light	Error, device error

NET LED

NET 	off	Device OFF, no supply voltage, EtherCAT communication not initialized or inactive
NET 	flashing green, steady flashing	Device status: PRE-OPERATIONAL
NET 	green, flashing, single flash	Device status: SAFE-OPERATIONAL
NET 	green, continuous light	Device status: OPERATIONAL
NET 	flashing red, steady flashing	Faulty configuration, device status: PRE-OPERATIONAL

NET 	red, flashing, single flash	Local error, e.g., synchronization error
NET 	red, flashing, double flash	Process Data Watchdog Timeout or EtherCAT Watchdog Timeout or Sync Manager Watchdog Timeout
NET 	red, continuous light	Bus error, no communication established to master

LED ACT0 / LINK0 (on the MS 358/MK 358)

ACT0  LINK0	green, continuous light yellow, flashing	Ethernet connected (LINK) Data communication (ACT)
--	---	---

LED ACT1 / LINK1 (on the MS 358/MK 358)

ACT1  LINK1	green, continuous light yellow, flashing	Ethernet connected (LINK) Data communication (ACT)
--	---	---



Note!

The detailed description of the LED states can be found in Chapter 8.

If a display is available, the following information appears successively during startup:

- Startup
- Device designation e.g. BCL 338i SM 102 D
- Readings Result

If Readings Result is displayed, the device is ready.

Operation of BCL 338i

After voltage (18 ... 30VDC) has been connected to the switching input, a read process is activated. In the standard setting, all common code types for decoding are released; only the **2/5 Interleaved** code type is limited to 10 digits of code content.

If a code is moved through the reading field, the code content is decoded and forwarded to the superior system (controller) via EtherCAT.

3.7 Bar code reading

To test, you can use the following bar code in the 2/5 Interleaved format. The bar code module here is 0.5:



Provided your BCL 338*i* model has a display, the read information appears on this display. The **PWR** LED goes off briefly and then turns green again. Simultaneously, the read information is forwarded to the superior system (PLC/PC) via the Ethernet.

Please check the incoming data of the bar code information there.

Alternatively, you can use a switching input for read activation (switching signal of a photo-electric sensor or 24 VDC switching signal).

4 Device description

4.1 About the bar code readers of the BCL 300*i* series

Bar code readers of the BCL 300*i* series are high-speed scanners with integrated decoder for all commonly used bar codes, e.g. 2/5 Interleaved, Code 39, Code 128, EAN 8/13 etc., as well as codes from the GS1 DataBar family.

Bar code readers of the BCL 300*i* series are available in various optics models as well as line scanners, line scanners with deflecting mirrors and oscillating mirrors and also optionally as heated models.

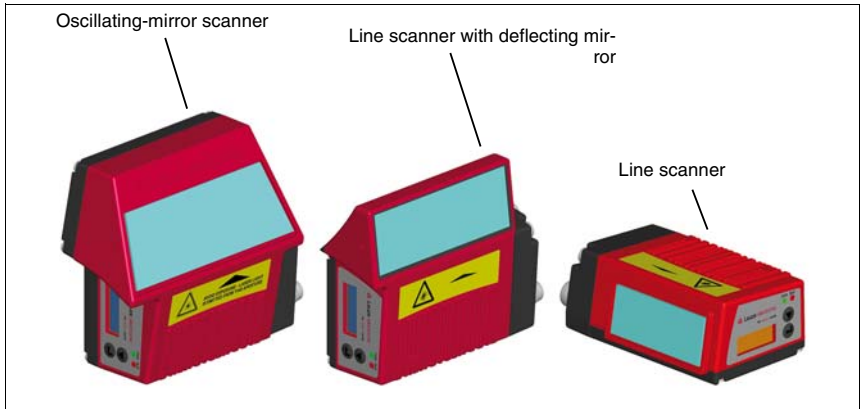


Figure 4.1: Line scanner, line scanner with deflecting mirror and oscillating-mirror scanner

The many possible configurations of the device allow it to be adapted to a multitude of reading tasks. Due to the large reading distance combined with the great depth of field, a large opening angle and a very compact construction, the device is ideally suited for the conveyor and storage technology market.

The interfaces (**RS 232**, **RS 485** and **RS 422**) integrated in the various device models and the fieldbus systems (**PROFIBUS DP**, **PROFINET-IO**, **Ethernet TCP/IP UDP**, **EtherNet/IP** and **EtherCAT**) offer optimum connection to the superior host system.

4.2 Characteristics of the bar code readers of the BCL 300*i* series

Performance characteristics:

- Integrated fieldbus connectivity = *i* -> Plug-and-Play fieldbus coupling and easy networking
- Numerous interface variants facilitate connection to the superior systems
 - RS 232, RS 422
 - RS 485 and multiNet plus slave
- Alternatively, various fieldbus systems, such as
 - PROFIBUS DP
 - PROFINET-IO
 - Ethernet TCP/IP UDP
 - EtherNet/IP
 - EtherCAT
- Integrated code reconstruction technology (**CRT**) enables the identification of soiled or damaged bar codes
- Maximum depth of field and reading distances from 30 mm to 700 mm
- Large optical opening angle and, thus, large reading field width
- High scanning rate with 1000 scans/s for fast reading tasks
- On request with display to easily detect and activate functions and status messages.
- Integrated USB service interface, Mini-B type
- Easy alignment and diagnostics functions
- Up to four possible connection technologies
- Two freely programmable switching inputs/outputs for the activation or signaling of states
- Automatic monitoring of the read quality with **autoControl**
- Automatic recognition and setting of the bar code type using **autoConfig**
- Reference code comparison
- Optional heating models to -35°C
- Heavy-duty housing of degree of protection IP 65



Note!

For information on technical data and characteristics, refer to Chapter 5.

General information

The integrated fieldbus connectivity = *i* contained in the bar code readers of the BCL 300*i* series facilitates the use of identification systems which function without connection unit or gateways. The integrated fieldbus interface considerably simplifies handling. The Plug-and-Play concept enables easy networking and very simple commissioning: Directly connect the respective fieldbus and all configuration is performed with no additional software.

For decoding bar codes, the bar code readers of the BCL 300*i* series make available the proven **CRT decoder** with code reconstruction technology:

The proven code reconstruction technology (**CRT**) enables bar code readers of the BCL 300*i* series to read bar codes with a small bar height, as well as bar codes with a damaged or soiled print image.

With the aid of the **CRT decoder**, bar codes can also be read without problem in other demanding situations, such as with a large tilt angle (azimuth angle or even twist angle).

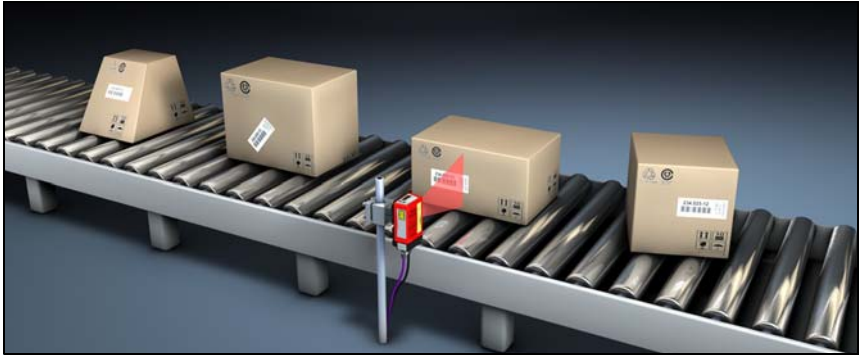


Figure 4.2: Possible bar code orientation

The BCL 338*i* can be operated and configured using the integrated webConfig tool via the USB service interface; alternatively, the bar code readers can be adjusted using configuration commands via the host/service interface.

The BCL 338*i* needs a suitable activation to start a read process as soon as an object is in the reading field. This opens a time window ("reading gate") in the BCL 338*i* for the read process during which the bar code reader has time to detect and decode a bar code.

In the basic setting, triggering takes place through an external reading cycle signal. Alternative activation options include online commands via the host interface and the **autoRefIAct** function.

Through the read operation, the BCL 338*i* collects additional useful pieces of data for diagnostics which can also be transmitted to the host. The quality of the read operation can be inspected using the **alignment mode** which is integrated in the webConfig tool.

An optional, multi-language display with buttons is used to operate the BCL 338*i* as well as for visualization purposes. Two LEDs provide additional optical information on the current operating state of the device.

The two freely configurable switching inputs/outputs **SWIO1** and **SWIO2** can be assigned various functions and control e.g. activation of the BCL 338*i* or external devices, such as a PLC.

System, warning and error messages provide assistance in setup/troubleshooting during commissioning and read operation.

4.3 Device construction

BCL 338i bar code reader

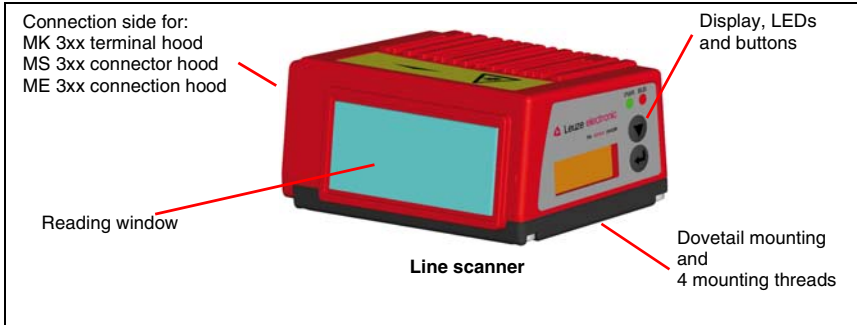


Figure 4.3: BCL 338i device construction - line scanner

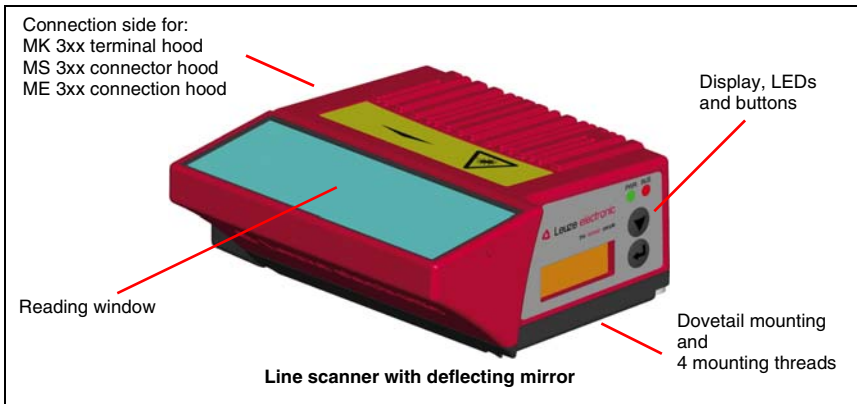


Figure 4.4: Device construction BCL 338i - Line scanner with deflecting mirror

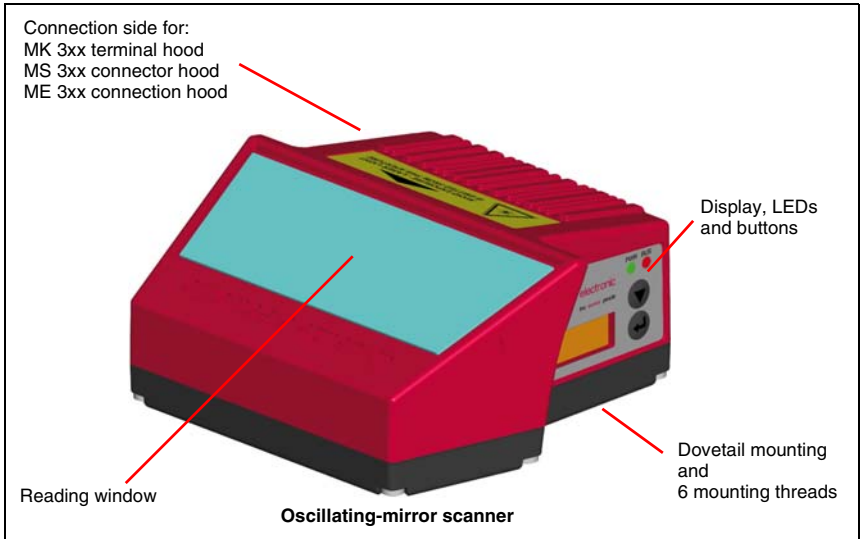


Figure 4.5: BCL 338*i* device construction - oscillating-mirror scanner

MS 338 connector hood

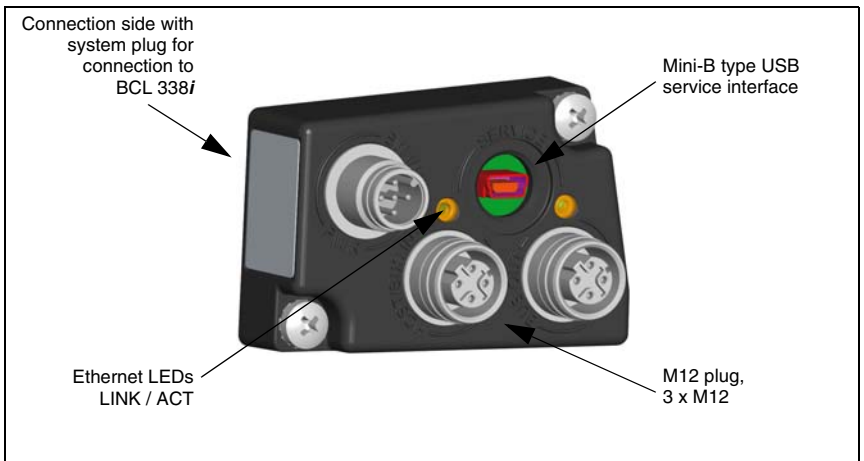


Figure 4.6: Device construction - MS 338 connector hood

MK 338 terminal hood

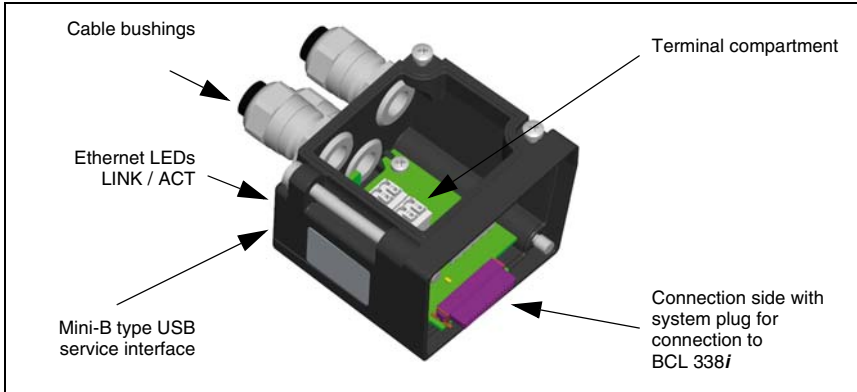


Figure 4.7: Device construction - MK 338 terminal hood

ME 338 103 / ME 338 104 / ME 338 214 connection hood

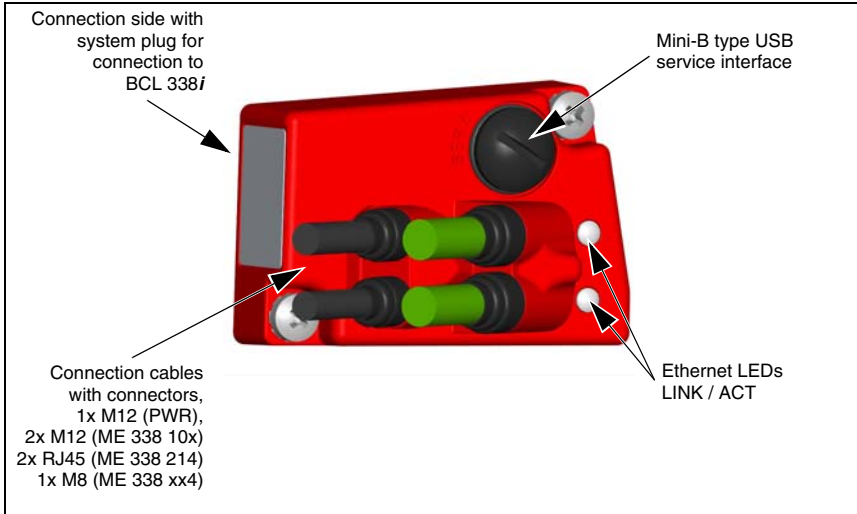


Figure 4.8: Device construction - MS 338 103 / MS 338 104 connector hoods

4.4 Reading techniques

4.4.1 Line scanner (single line)

A line (scan line) scans the label. Due to the opt. opening angle, the reading field width is dependent on the read distance. Through the movement of the object, the entire bar code is automatically transported through the scan line.

The integrated code reconstruction technology permits twisting of the bar code (tilt angle) within certain limits. These are dependent on the transport speed, the scanning rate of the scanner and the bar code properties.

Areas of application of the line scanner

The line scanner is used:

- when the bars of the bar code are printed in the conveying direction ('ladder arrangement').
- with bar codes having very short bar lengths.
- when the ladder code is turned out of the vertical position (tilt angle).
- when the reading distance is large.



Figure 4.9: Deflection principle for the line scanner

4.4.2 Line scanner with oscillating mirror

The oscillating mirror deflects the scan line additionally to both sides across the scan direction at a randomly adjustable oscillation frequency. In this way, the BCL 338*i* can also scan larger areas or spaces for bar codes. The reading field height (and the scan line length useful for evaluation) depends on the reading distance due to the optical opening angle of the oscillating mirror.

Areas of application of the line scanner with oscillating mirror

For line scanners with oscillating mirror, oscillation frequency, start/stop position etc. are adjustable. It is used:

- when the position of the label is not fixed, e.g. on pallets – various labels can, thus, be detected at various positions.
- When the bars of the bar code are printed perpendicular to the conveying direction ("picket fence arrangement").
- when reading stationary objects.
- when a large reading field (reading window) has to be covered.

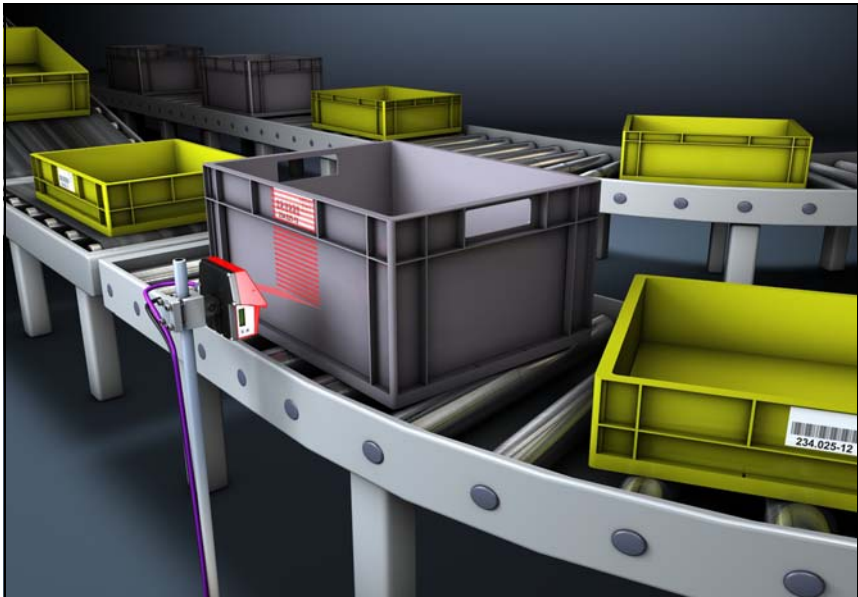


Figure 4.10: Deflection principle for the line scanner with oscillating mirror add-on

4.4.3 Raster scanner (raster line)

Multiple scan lines scan the label. Due to the optical opening angle, the reading field width is dependent on the read distance. Provided the code is located in the reading field, it can be read during standstill. If the code moves through the reading field, it is scanned by multiple scan lines.

The integrated code reconstruction technology permits twisting of the bar code (tilt angle) within certain limits. These are dependent on the transport speed, the scanning rate of the scanner and the bar code properties. In most cases, everywhere a line scanner is used, a raster scanner can be used.

Areas of application of the raster scanner:

The raster scanner is used:

- When the bars of the bar code are perpendicular to the conveying direction (picket fence arrangement)
- With bar codes with low height displacement
- With very glossy bar codes



Figure 4.11: Deflection principle for the raster scanner

4.5 Fieldbus systems

Various product variants of the BCL 300*i* series are available for connecting to different fieldbus systems such as PROFIBUS DP, PROFINET, Ethernet, EtherNet/IP and EtherCAT.

4.5.1 EtherCAT

General information on EtherCAT

EtherCAT is an Ethernet-based fieldbus initiated by the Beckhoff corporation. The EtherCAT Technology Group (ETG) is the official standardization partner of the IEC working groups.

EtherCAT has been an IEC standard since 2005.

- IEC 61158: Protocols and services
- IEC 61784-2: Communication profiles for the specific device classes

All EtherCAT-specific communication mechanisms are described in detail in the standards mentioned above. This technical description will describe parts of the IEC standard if this assists general understanding.

EtherCAT topology

EtherCAT permits a multitude of topologies such as line, tree, ring, star and combinations of these. The bus or line structure known from the fieldbuses is thus also available for EtherCAT.

Telegrams are sent on a wire pair in the "processing direction" from the master to the slave. The EtherCAT device processes the frames only in this direction and passes them on to the subsequent device until the telegram has passed through all devices. The last device sends the telegram back to the master on the second wire pair of the bus cable in the "forward direction". Here, the EtherCAT always forms a logical ring structure regardless of the topology installed.

From an Ethernet point of view, an EtherCAT bus segment is nothing more than a single, large Ethernet participant which sends and receives Ethernet telegrams. Within the "participant", however, there is a multitude of EtherCAT slaves rather than one single Ethernet controller.

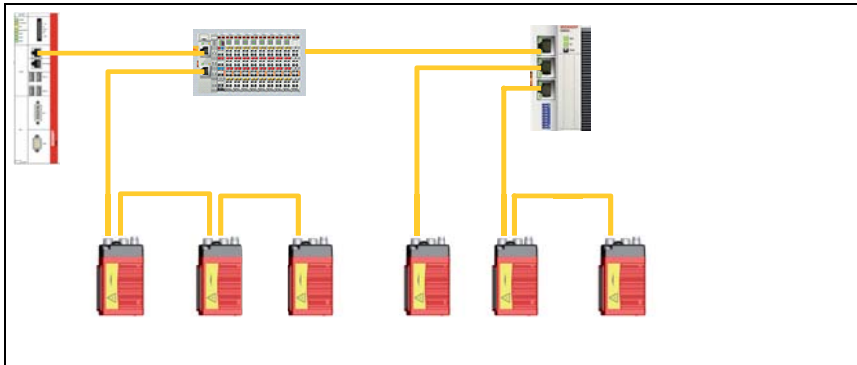


Bild 4.12: Topology example

4.6 Heating

For low-temperature applications to min. -35°C (e.g. in cold storage), the bar code readers of the BCL 338*i* series can optionally be permanently fitted with a built-in heating and these bar code readers purchased as separate device models.

4.7 autoRefIAct

autoRefIAct stands for **automatic Reflector Activation** and permits an activation without additional sensors. This is achieved by directing the scanner with reduced scanning beam towards a reflector mounted behind the conveyor path.



Note!

Compatible reflectors are available on request.

As long as the scanner is targeted at the reflector, the reading gate remains closed. If, however, the reflector is blocked by an object such as a container with a bar code label, the scanner activates the read procedure, and the label on the container is read. When the path from the scanner to the reflector has cleared, the read procedure has completed and the scanning beam is reduced and again directed onto the reflector. The reading gate is closed.

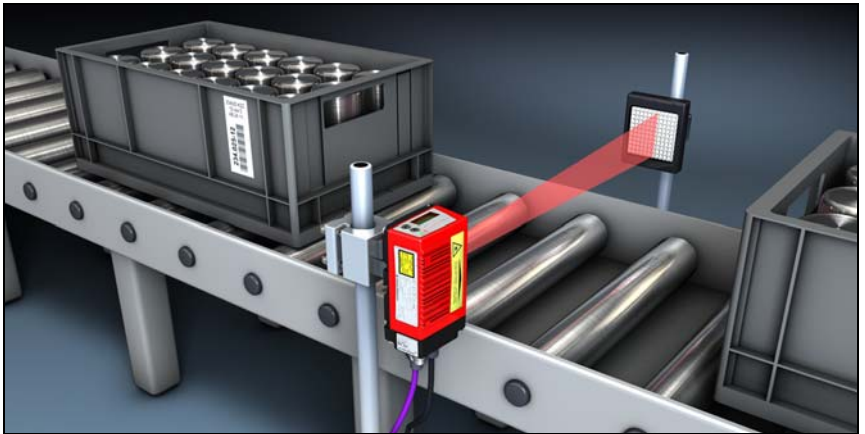


Figure 4.13: Reflector arrangement for autoRefIAct

The **autoRefIAct** function uses the scanning beam to simulate a photoelectric sensor and thus permits an activation without additional sensors.

4.8 Reference codes

The BCL 338*i* offers the possibility of storing one or two reference codes.

It is possible to store the reference codes via the webConfig tool or via online commands.

The BCL 338*i* can compare read bar codes with one and/or both reference codes and execute user-configurable functions depending on the comparison result.

4.9 autoConfig

With the autoConfig function, the BCL 338*i* offers an extremely simple and convenient configuration option to users who only want to read one code type (symbology) with one number of digits at a time.

After starting the autoConfig function via the switching input or from a superior control, it is sufficient to position a bar code label with the desired code type and number of digits in the reading field of the BCL 338*i*.

Afterward, bar codes with the same code type and number of digits are recognized and decoded.

5 Technical data

5.1 General specifications of the bar code readers

5.1.1 Line scanner / raster scanner

Type	BCL 338i EtherCAT
Design	Line scanner without heating
Optical data	
Light source	Laser diode
Laser class	2 acc. to IEC 60825-1:2007
Wavelength	655nm (red light)
Max. output power (peak)	≤ 1.8mW
Impulse duration	≤ 150µs
Beam exit	At the front
Scanning rate	1000 scans/s
Beam deflection	Via rotating polygon wheel
Useful opening angle	Max. 60°
Optics models / resolution	High Density (N): 0.127 ... 0.20mm Medium Density (M): 0.20 ... 0.5 mm Low Density (F): 0.30 ... 0.5 mm Ultra Low Density (L): 0.35 ... 0.8mm
Reading distance	See reading field curves
Laser class	2 (acc. to EN 60825-1 and 21 CFR 1040.10 with Laser Notice No. 50)
Bar code data	
Code types	2/5 Interleaved, Code 39, Code 128, EAN 128, EAN / UPC, Codabar, Code 93, GS1 DataBar, EAN Addendum
Bar code contrast (PCS)	>= 60%
Ambient light tolerance	2000 lx (on the bar code)
Number of bar codes per scan	3
Electrical data	
Interface type	2x Ethernet on 2x M12 (D-coded)
Protocols	EtherCAT, CoE and EoE
Baud rate	100Mbaud (100Base-TX)
Data formats	
Service interface	USB 2.0 Mini-B type socket
Switching input / switching output	2 switching inputs/outputs, freely programmable functions - Switching input: 18 ... 30 V DC depending on supply voltage, I max. = 8 mA - Switching output: 18 ... 30 VDC depending on supply voltage, I max. = 60mA (short-circuit proof) Switching inputs/outputs protected against polarity reversal!
Operating voltage	18 ... 30VDC (Class 2, protection class III)
Power consumption	Max. 4.5W

Table 5.1: Technical data of the BCL 338i line/raster scanners without heating

Type	BCL 338i EtherCAT
Design	Line scanner without heating
Operating and display elements	
Display	Monochromatic graphical display, 128 x 32 pixel, with background lighting
Keyboard	2 keys
LEDs	2 LEDs for power (PWR) and bus state (NET), two-colored (red/green)
Mechanical data	
Degree of protection	IP 65 ¹⁾
Weight	270 g (without connection hood)
Dimensions (H x W x D)	44 x 95 x 68 mm (without connection hood)
Housing	Diecast aluminum
Environmental data	
Operating temperature range	0 °C ... -40 °C
Storage temperature range	-20°C ... +70°C
Air humidity	Max. 90% rel. humidity, non-condensing
Vibration	IEC 60068-2-6, test Fc
Shock	IEC 60068-2-27, test Ea
Continuous shock	IEC 60068-2-29, test Eb
Electromagnetic compatibility	EN 55022; IEC 61000-6-2 (contains IEC 61000-4-2, -3, -4, -5 and -6) ²⁾

Table 5.1: Technical data of the BCL 338i line/raster scanners without heating

- 1) Only with MS 338/ME 338/MK 338 connection hoods and screwed-on M12 connectors or cable bushings and mounted caps. Minimum tightening torque of the housing connecting screw of the connection hood is 1.4Nm!
- 2) This is a Class A product. In a domestic environment this product may cause radio interference, in which case the operator may be required to take adequate measures.



Attention!

For UL applications, use is only permitted in Class 2 circuits in accordance with the NEC (National Electric Code).



The BCL 338i bar code readers are designed in accordance with protection class III for supply by PELV (protective extra-low voltage with reliable disconnection).

5.1.2 Oscillating-mirror scanner

Technical data same as for line scanner without heating, however with the following differences:

Type	BCL 338i EtherCAT
Design	Oscillating-mirror scanner without heating
Optical data	
Beam exit	Lateral zero position at an angle of 90°
Beam deflection	Via rotating polygon wheel (horizontal) and stepping motor with mirror (vertical)
Oscillation frequency	0 ... 10 Hz (adjustable, max. frequency is dependent on set swivel angle)
Max. swivel angle	±20° (adjustable)
Reading field height	See reading field curves
Electrical data	
Power consumption	Max. 9.0W
Mechanical data	
Weight	580 g (without connection hood)
Dimensions (H x W x D)	58 x 125 x 110 mm (without connection hood)

Table 5.2: Technical data of the BCL 338i oscillating-mirror scanners with heating

5.1.3 Line / raster scanner with deflecting mirror

Technical data same as for line scanner without heating, however with the following differences:

Type	BCL 338i EtherCAT
Design	Line scanner with deflecting mirror without heating
Optical data	
Beam exit	Lateral zero position at an angle of 105°
Beam deflection	Via rotating polygon wheel (horizontal) and deflecting mirror (vertical)
Electrical data	
Power consumption	Max. 4.5W
Mechanical data	
Weight	350 g (without connection hood)
Dimensions (H x W x D)	44 x 103 x 96 mm (without connection hood)

Table 5.3: Technical data of the BCL 338i deflecting mirror scanners without heating

5.2 Heating models of the bar code readers

The BCL 338*i* bar code readers are optionally available as models with integrated heating. In this case, heating is permanently installed ex works. Self-installation on-site by the user is not possible!

Features

- Integrated heating (permanently installed)
- Extends the application range of the BCL 338*i* to -35 °C
- Supply voltage 18 ... 30VDC
- Enabling the BCL 338*i* through an internal temperature switch (switch-on delay about 30 min for 24 V DC and minimum ambient temperature of -35 °C)
- Necessary conductor cross-section for the voltage supply: at least 0.75 mm²; the use of ready-made cables is, thus, not possible

Structure

The heating consists of two parts:

- The front cover heater
- The housing heater

Function

When the 24 V DC supply voltage is applied to the BCL 338*i*, a temperature switch initially only connects the heating to electrical power (front cover heater and housing heater). During the heating phase (around 30 min), when the inside temperature rises above 15 °C, the temperature switch connects the BCL 338*i* to the supply voltage. This is followed by the self test and the changeover to read operation. The **PWR** LED lights up, showing overall readiness for operation.

When the inside temperature reaches approx. 18 °C, another temperature switch turns the housing heater off and, if necessary, back on again (if the inside temperature drops below 15 °C). This does not interrupt the read operation. The front cover heater remains activated until an inside temperature of 25 °C is reached. At temperatures above this, the front cover heater switches off and, with a switching hysteresis of 3 °C, back on again at an inside temperature below 22 °C.

Mounting location



Note!

*The mounting location is to be selected such that it does not expose the BCL 338*i* with heating directly to a cold air stream. To achieve an optimal heating effect, the BCL 338*i* should be mounted so that it is thermally isolated.*

Electrical connection

The required wire cross section of the connection cable for the voltage supply must be at least 0.75 mm².



Attention!

The voltage supply must not be looped through from one device to the next.

Power consumption

The energy requirement depends on the model:

- the line/raster scanner with heating consumes a maximum of 27W power.
- the line scanner with oscillating mirror and heating consumes a maximum of 45W.
- the line/raster scanner with deflecting mirror and heating consumes a maximum of 27W power.

These values are based on operation with unconnected switching outputs.

5.2.1 Line scanner / raster scanner with heating

Technical data same as for line scanner without heating, however with the following differences:

Type	BCL 338i EtherCAT
Design	Line scanner with heater
Electrical data	
Operating voltage	18 ... 30VDC
Power consumption	Max. 27.0W
Structure of the heating	Housing heating and separate heating of the optics glass
Warmup time	Min. 30 min at +24 V DC and an ambient temperature of -35 °C
Min. conductor cross section	Conductor cross section of at least 0.75 mm ² for the supply-voltage line. Wiring through of the voltage supply to multiple heating devices is not permissible. Standard, M12 ready-made cable not usable (insufficient conductor cross section)
Environmental data	
Operating temperature range	-35°C ... +40°C
Storage temperature range	-20°C ... +70°C

Table 5.4: Technical data of the BCL 338i line / raster scanners with heating

5.2.2 Oscillating-mirror scanner with heating

Technical data same as for line scanner without heating, however with the following differences:

Type	BCL 338i EtherCAT
Design	
Optical data	
Useful opening angle	Max. 60°
Max. swivel angle	±20° (adjustable)

Table 5.5: Specifications of the BCL 338i oscillating-mirror scanners with heating

Type	BCL 338i EtherCAT
Design	
Electrical data	
Operating voltage	18 ... 30VDC
Power consumption	Max. 45.0W
Structure of the heating	Housing heating and separate heating of the optics glass
Warmup time	Min. 30 min at +24 V DC and an ambient temperature of -35 °C
Min. conductor cross section	Conductor cross section of at least 0.75 mm ² for the supply-voltage line. Wiring through of the voltage supply to multiple heating devices is not permissible. Standard, M12 ready-made cable not usable (insufficient conductor cross section)
Environmental data	
Operating temperature range	-35°C ... +40°C
Storage temperature range	-20°C ... +70°C

Table 5.5: Specifications of the BCL 338i oscillating-mirror scanners with heating

5.2.3 Line scanner / raster scanner with deflecting mirror and heating

Technical data same as for line scanner without heating, however with the following differences:

Type	BCL 338i EtherCAT
Design	
Optical data	
Useful opening angle	Max. 60°
Electrical data	
Operating voltage	18 ... 30VDC
Power consumption	Max. 27.0W
Structure of the heating	Housing heating and separate heating of the optics glass
Warmup time	Min. 30 min at +24 V DC and an ambient temperature of -35 °C
Min. conductor cross section	Conductor cross section of at least 0.75 mm ² for the supply-voltage line. Wiring through of the voltage supply to multiple heating devices is not permissible. Standard, M12 ready-made cable not usable (insufficient conductor cross section)
Environmental data	
Operating temperature range	-35°C ... +40°C
Storage temperature range	-20°C ... +70°C

Table 5.6: Technical data of the BCL 338i deflecting mirror scanners with heating

5.3 Dimensioned drawings

5.3.1 Dimensioned drawing of complete overview of the BCL 338*i* with MS 3xx / MK 3xx / ME 3xx

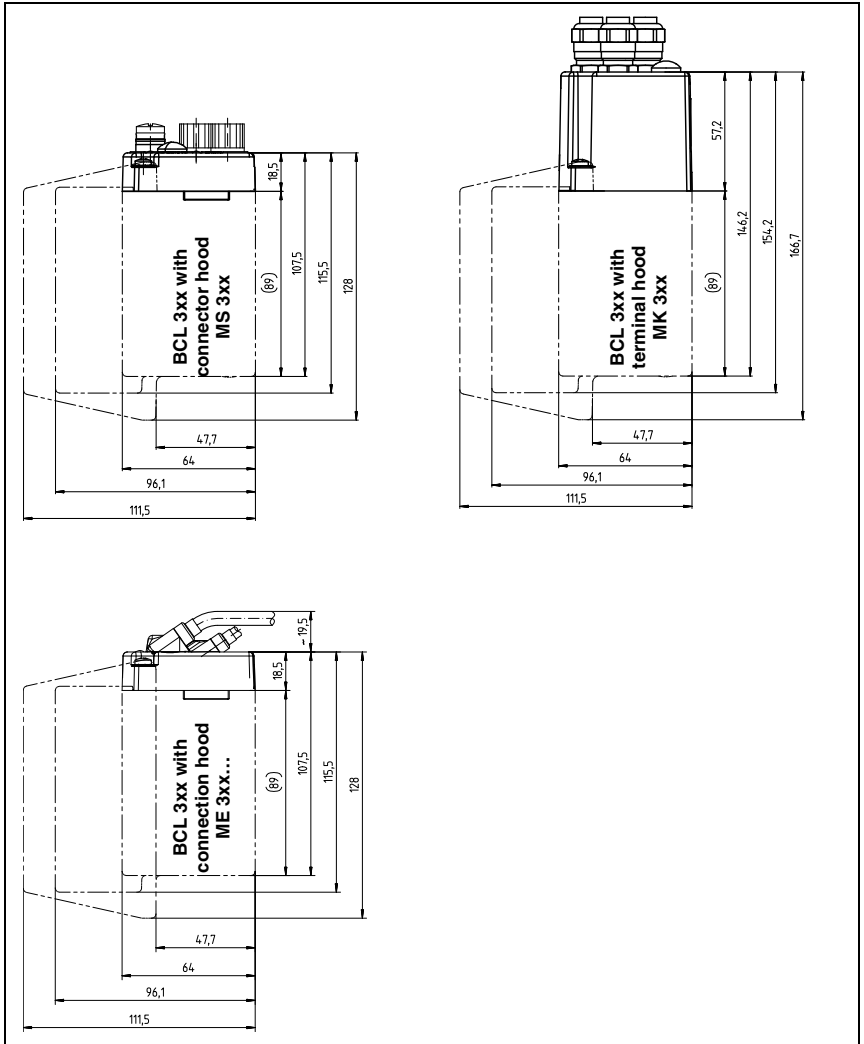


Figure 5.1: Dimensioned drawing of complete overview of the BCL 338*i* with MS 3xx / MK 3xx / ME 3xx

5.3.2 Dimensioned drawing of line scanner with / without heating

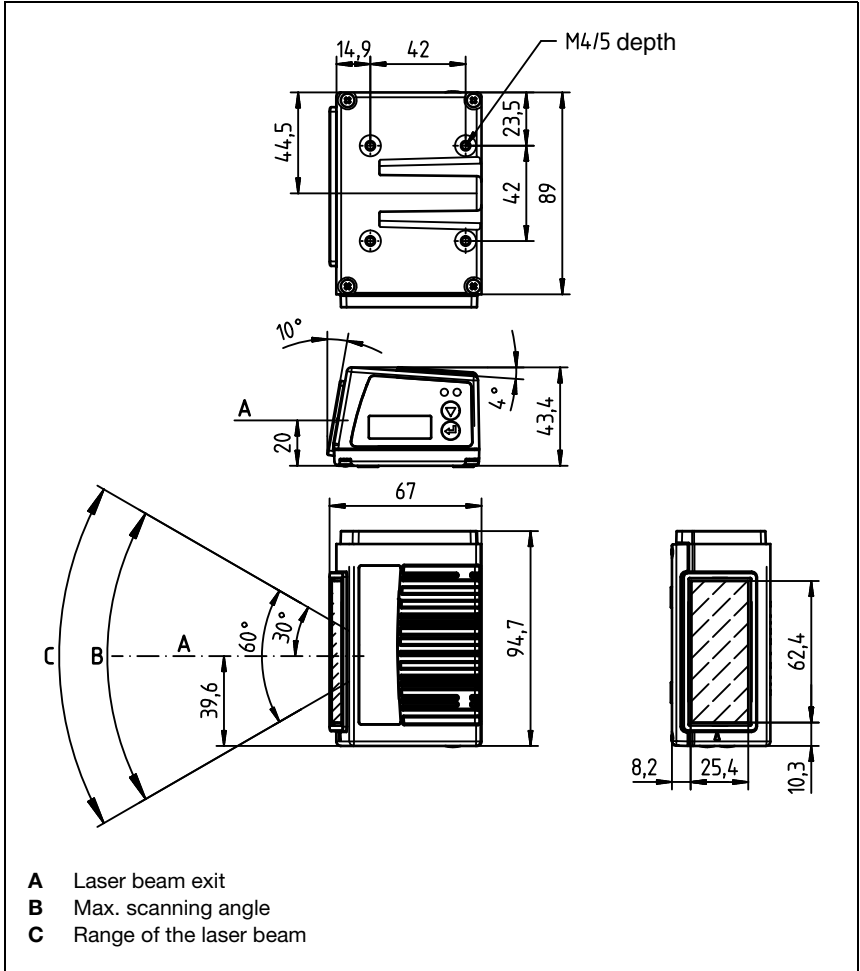


Figure 5.2: Dimensioned drawing of BCL 338i S...102 line scanner

5.3.3 Dimensioned drawing of deflecting mirror scanner with / without heating

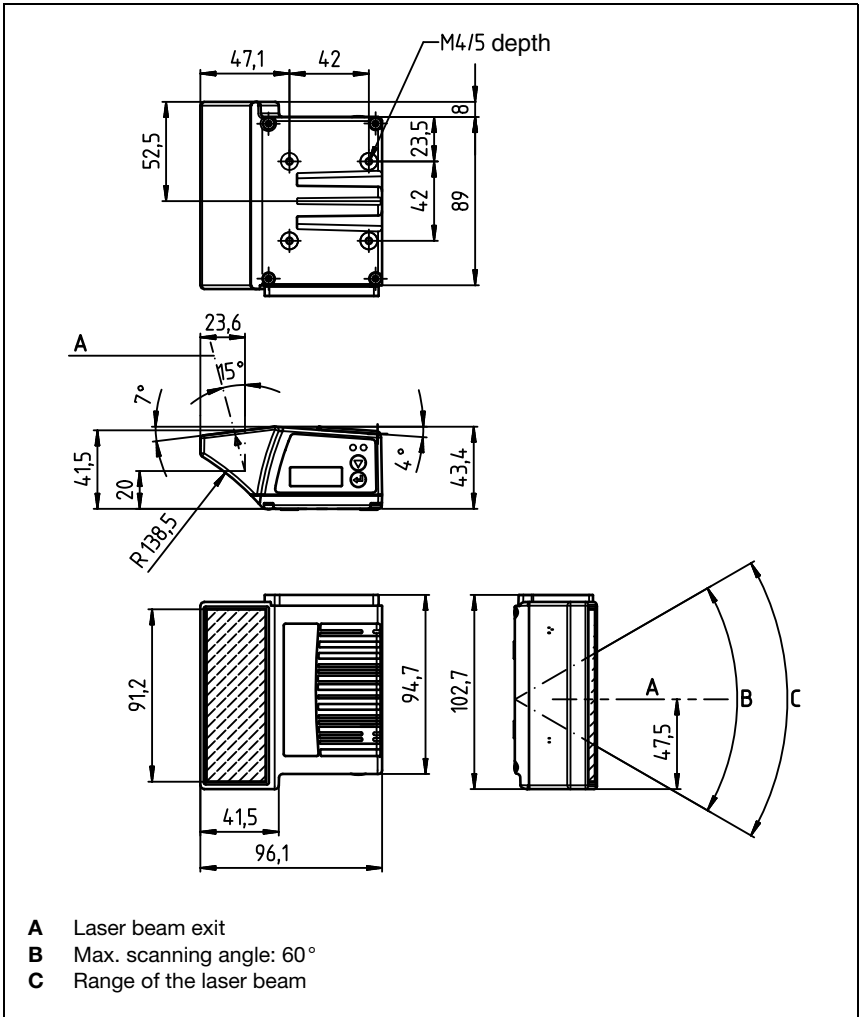


Figure 5.3: Dimensioned drawing of BCL 338i S...100 with deflecting mirror

5.3.4 Dimensioned drawing of oscillating-mirror scanner with / without heating

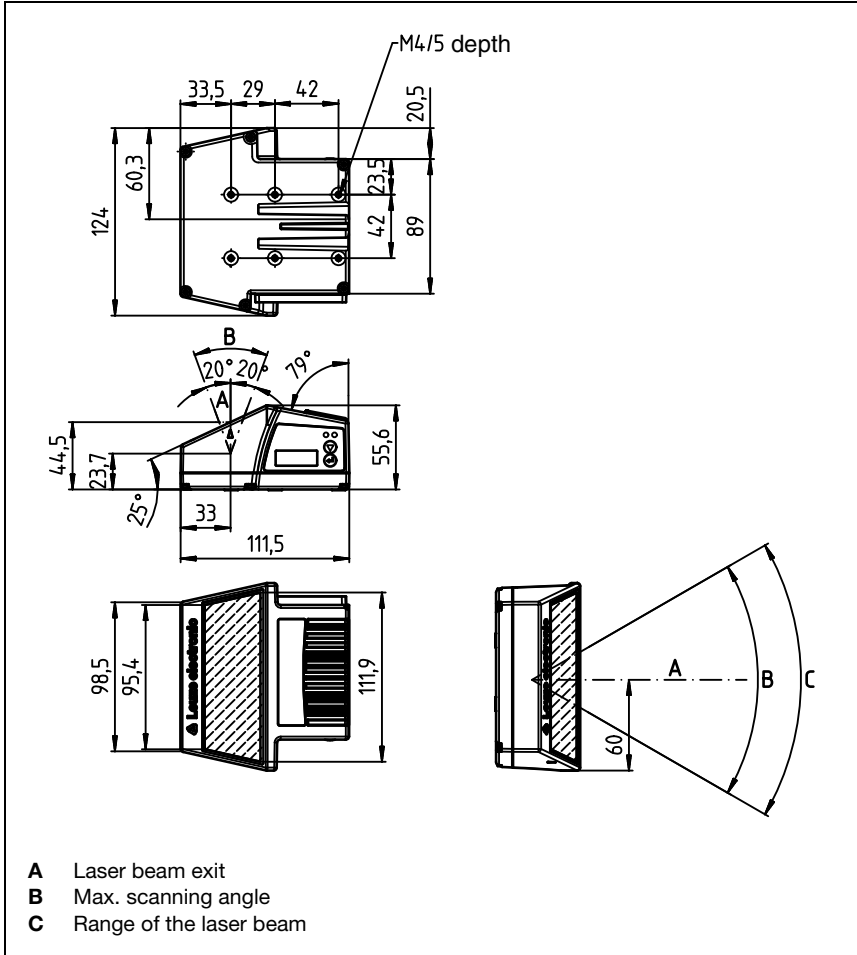


Figure 5.4: Dimensioned drawing of BCL 338i/O...100 oscillating-mirror scanner

5.3.5 Dimensioned drawings of MS 3xx / ME 3xx / MK 3xx connection hoods

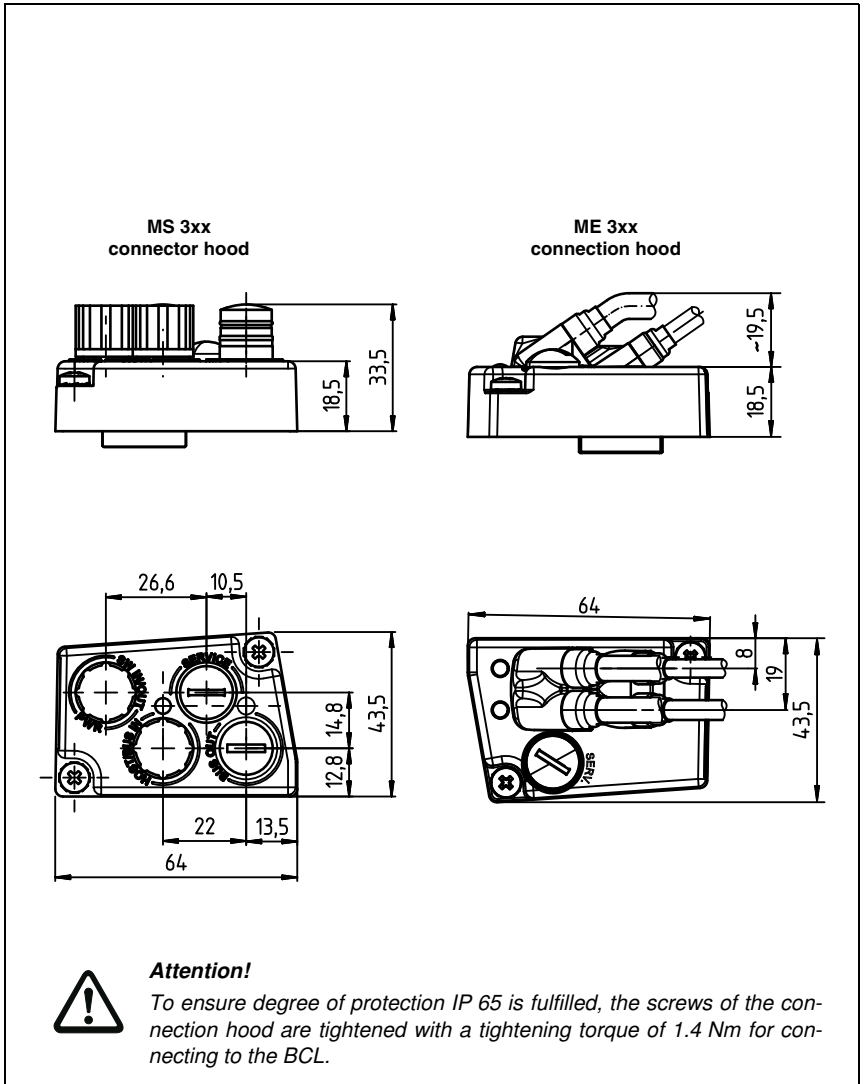


Figure 5.5: Dimensioned drawing of MS 3xx connector hood / ME 3xx connection hood

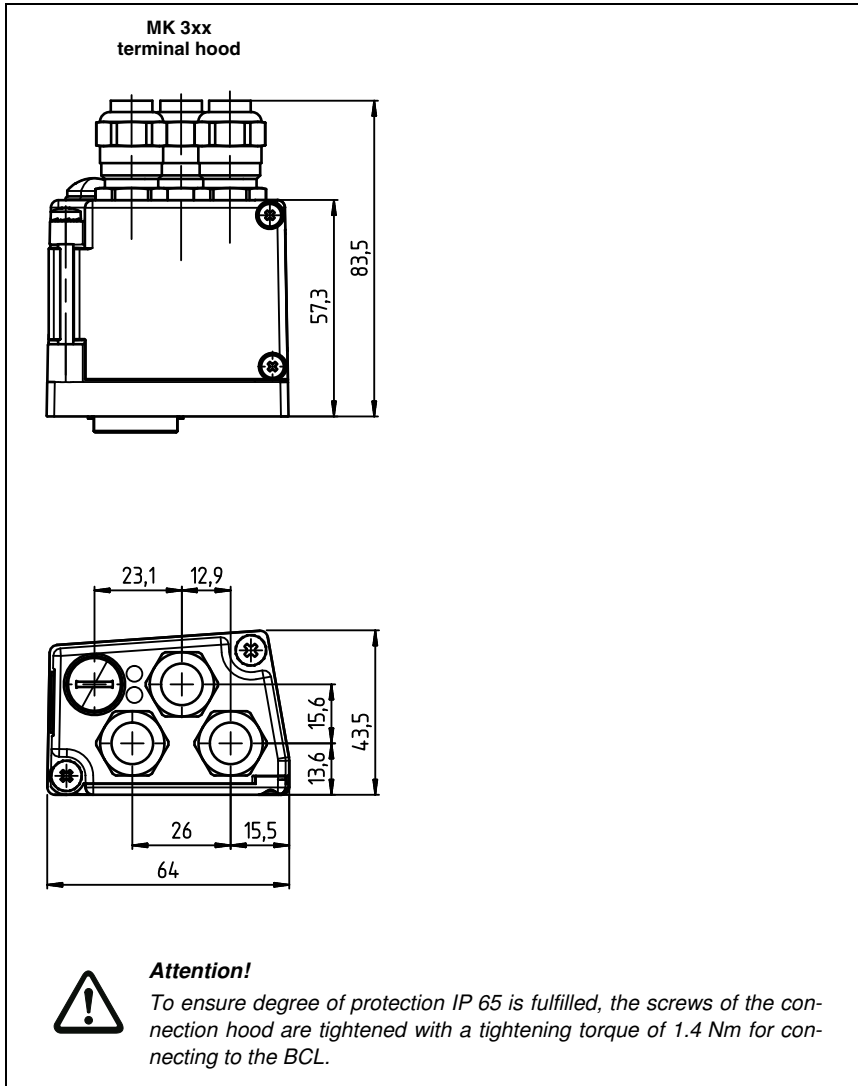


Figure 5.6: Dimensioned drawing of MK 3xx terminal hood

5.4 Reading field curves / optical data

5.4.1 Bar code characteristics



Note!

Please note that the size of the bar code module influences the maximum reading distance and the width of the reading field. Therefore, when selecting a mounting location and/or the bar code label, take into account the different reading characteristics of the scanner with various bar code modules.

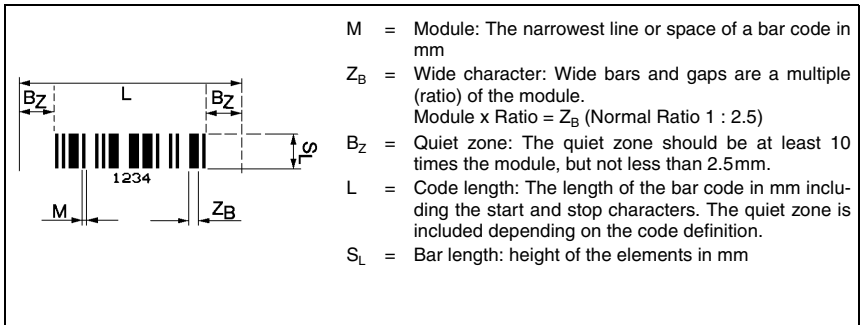


Figure 5.7: The most important characteristics of a bar code

The range in which the bar code can be read by the BCL 338*i* (the so-called reading field) depends on the quality of the printed bar code and its dimensions.

Therefore, above all, the module of a bar code is decisive for the size of the reading field.



Note!

A rule of thumb: The smaller the module of the bar code is, the smaller the maximum reading distance and reading field width will be.

5.4.2 Raster scanner

A raster variant is also available in the BCL 300*i* series. The BCL 300*i* as a raster scanner projects 8 scan lines which vary depending on the reading distance from the raster aperture.

		Distance [mm] starting at the zero position						
		50	100	200	300	400	450	700
Raster line cover [mm] all raster lines	Front scanner	8	14	24	35	45	50	77
	Deflecting mirror scanner	12	17	27	38	48	54	80

Table 5.7: Raster line cover dependent on the distance

5.5 Reading field curves



Note!

Please notice that the real reading fields are also influenced by factors such as labeling material, printing quality, reading angle, printing contrast etc., and may thus deviate from the reading fields specified here.

The reading field curves also apply for the device models with heating.

The zero position of the reading distance always refers to the front edge of the housing of the beam exit and is shown for the three housing types of the BCL 338*i* in Figure 5.8.

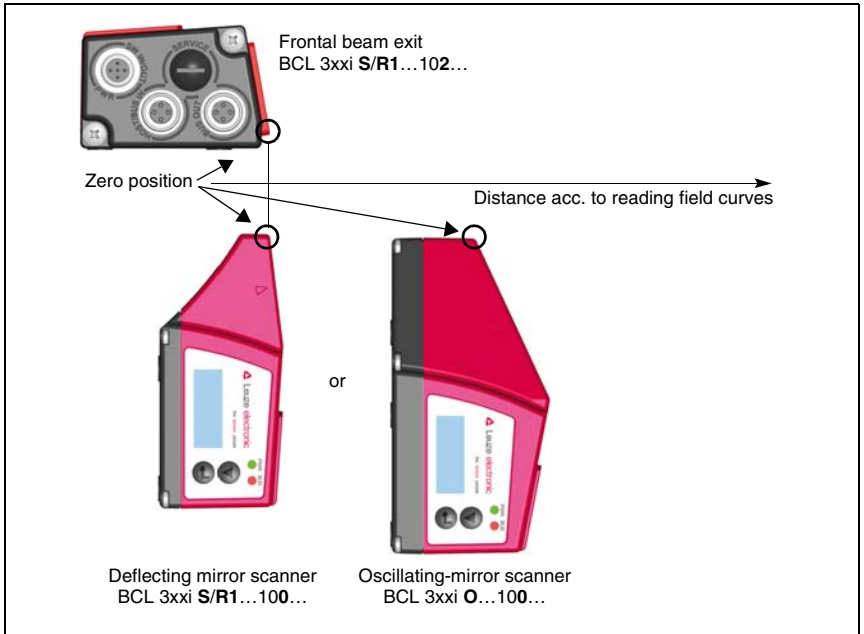


Figure 5.8: Zero position of the reading distance

Reading conditions for the reading field curves

Bar code type	2/5 Interleaved
Ratio	1:2.5
ANSI specification	Class A
Reading rate	> 75%

Table 5.8: Reading conditions

5.5.1 High Density (N) - optics: BCL 338i/S/R1 N 102 (H)

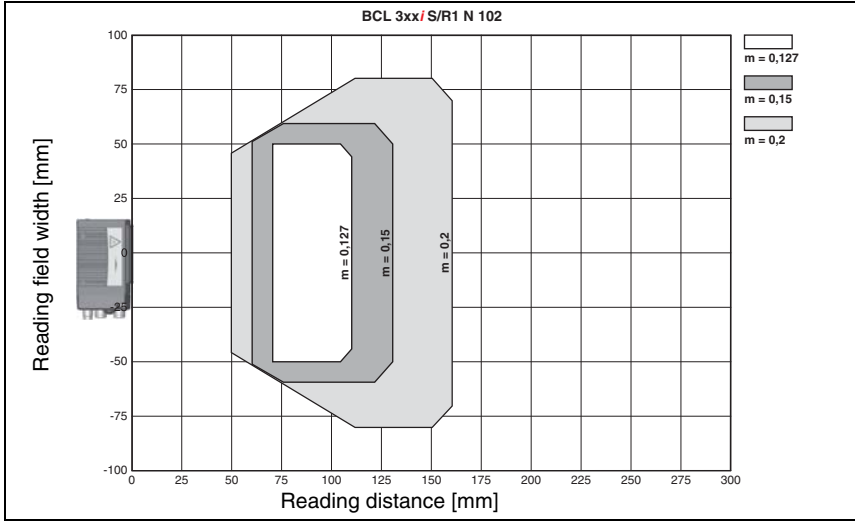


Figure 5.9: "High Density" reading field curve for line scanner without deflecting mirror

5.5.2 High Density (N) - optics: BCL 338i/S/R1 N 100 (H)

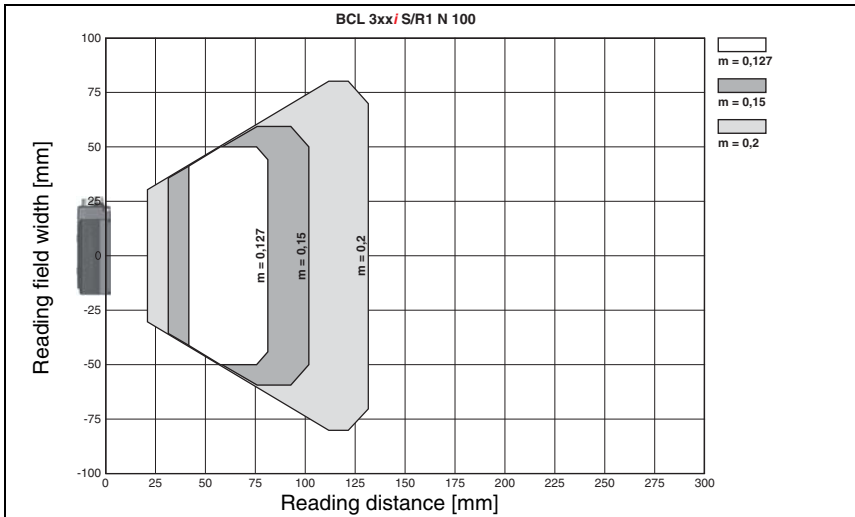


Figure 5.10: "High Density" reading field curve for line scanner with deflecting mirror

The reading field curve applies for the reading conditions stated in Table 5.8.

5.5.3 Medium Density (M) - optics: BCL 338i S/R1 M 102 (H)

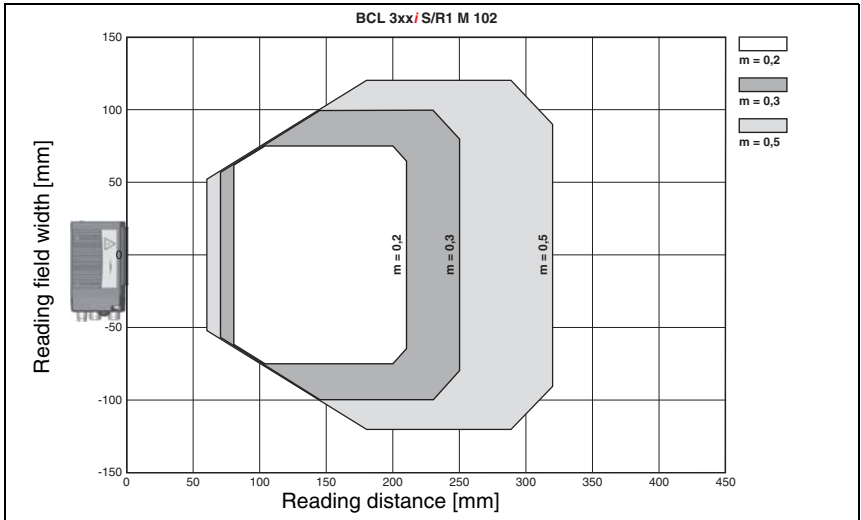


Figure 5.11: "Medium Density" reading field curve for line scanner without deflecting mirror

5.5.4 Medium Density (M) - optics: BCL 338i S/R1 M 100 (H)

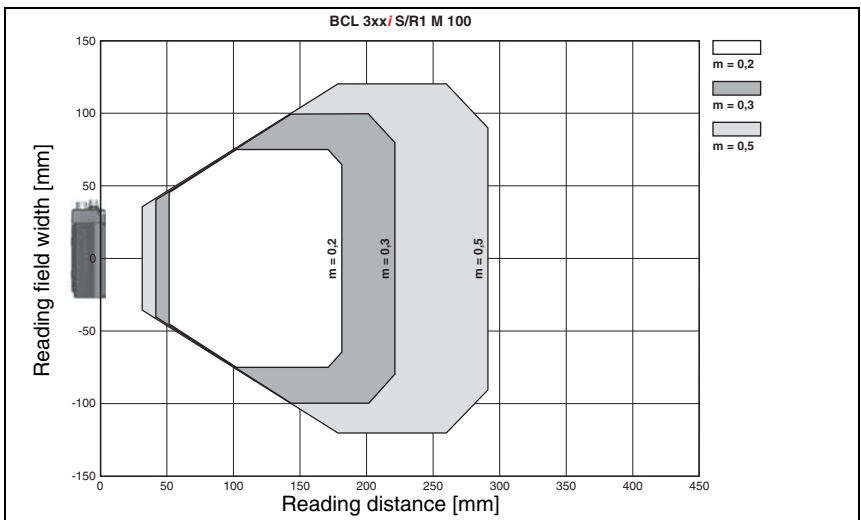


Figure 5.12: "Medium Density" reading field curve for line scanner with deflecting mirror

The reading field curves apply for the reading conditions stated in Table 5.8.

5.5.5 Medium Density (M) - optics: BCL 338i O M 100 (H)

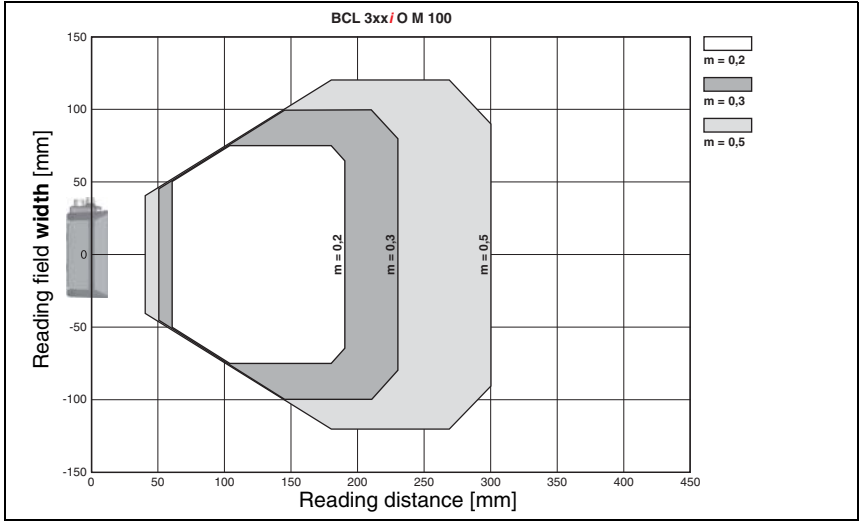


Figure 5.13: "Medium Density" reading field curve for oscillating-mirror scanners

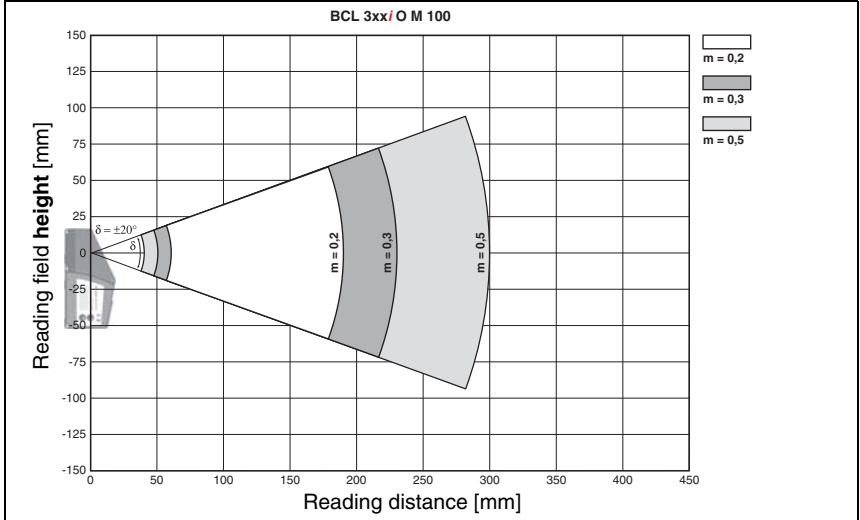


Figure 5.14: Lateral "Medium Density" reading field curve for oscillating-mirror scanners

The reading field curves apply for the reading conditions stated in Table 5.8.

5.5.6 Low Density (F) - optics: BCL 338i S/R1 F 102 (H)

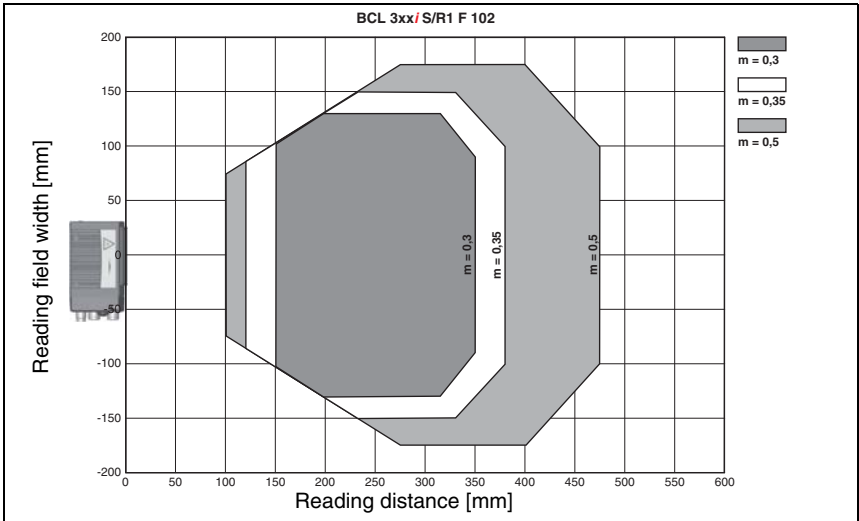


Figure 5.15: "Low Density" reading field curve for line scanner without deflecting mirror

5.5.7 Low Density (F) - optics: BCL 338i S/R1 F 100 (H)

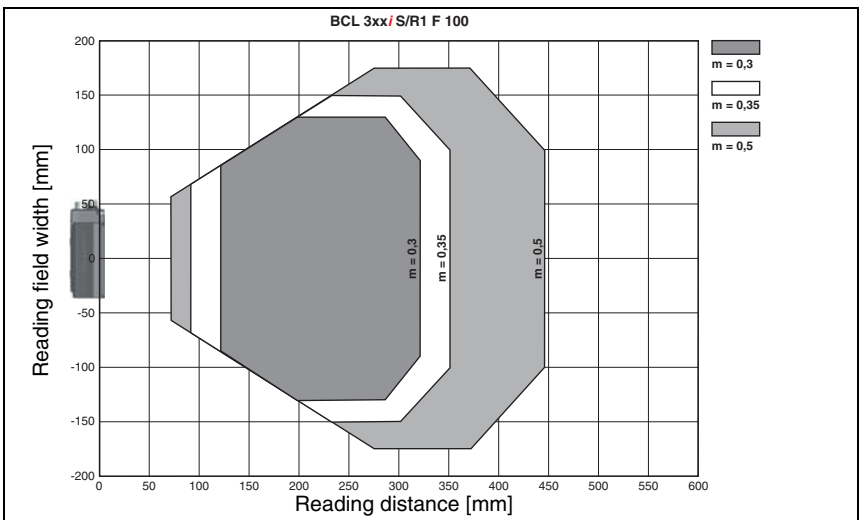


Figure 5.16: "Low Density" reading field curve for line scanner with deflecting mirror

The reading field curves apply for the reading conditions stated in Table 5.8.

5.5.8 Low Density (F) - optics: BCL 338i O F 100 (H)

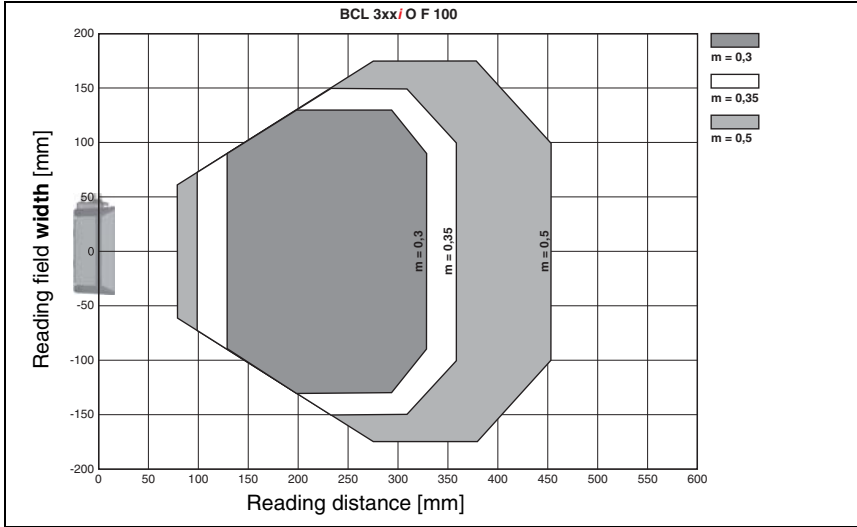


Figure 5.17: "Low Density" reading field curve for oscillating-mirror scanners

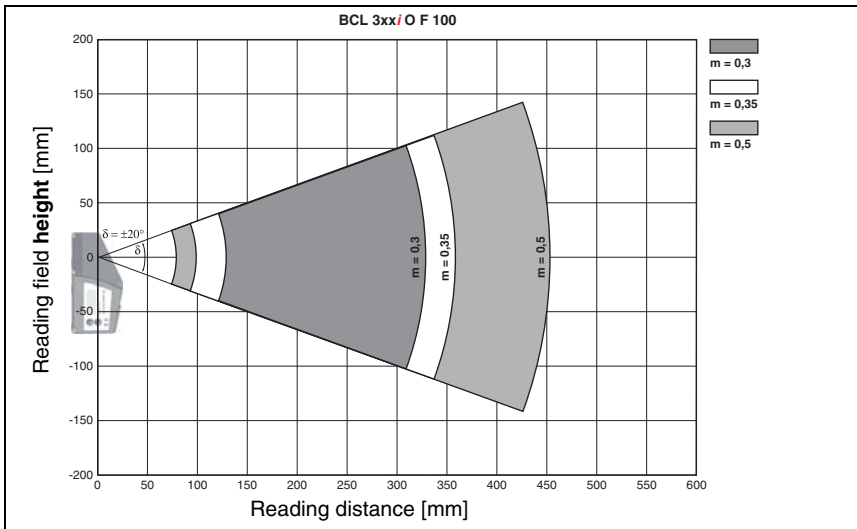


Figure 5.18: Lateral "Low Density" reading field curve for oscillating-mirror scanners

The reading field curves apply for the reading conditions stated in Table 5.8.

5.5.9 Ultra Low Density (L) - optics: BCL 338i S L 102 (H)

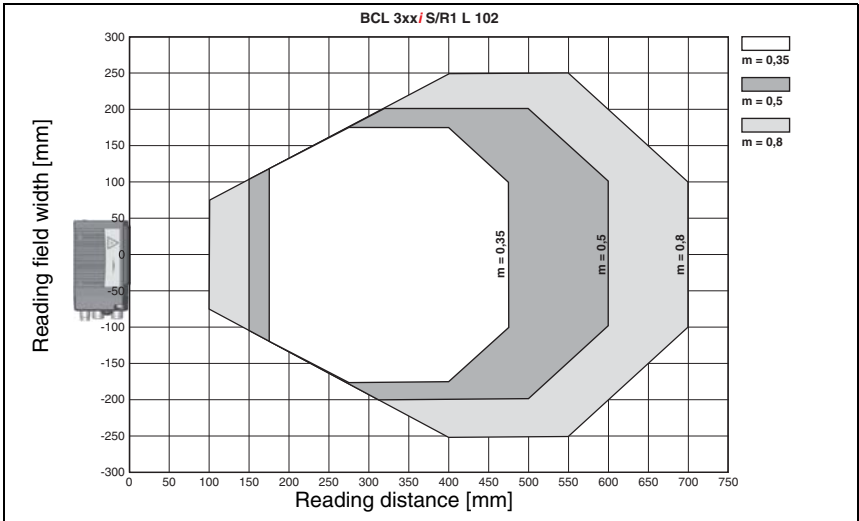


Figure 5.19: "Ultra Low Density" reading field curve for line scanner without deflecting mirror

5.5.10 Ultra Low Density (L) - optics: BCL 338i S L 100 (H)

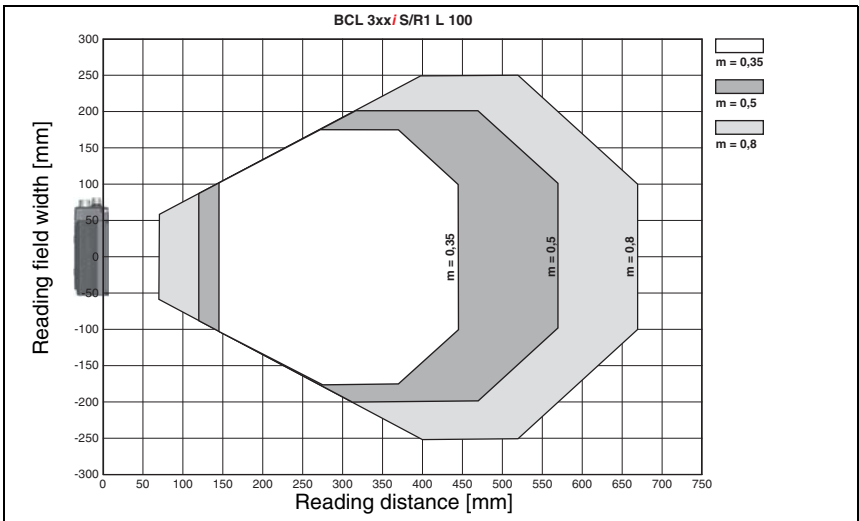


Figure 5.20: "Ultra Low Density" reading field curve for line scanner with deflecting mirror

The reading field curves apply for the reading conditions stated in Table 5.8.

5.5.11 Ultra Low Density (L) - optics: BCL 338i O L 100 (H)

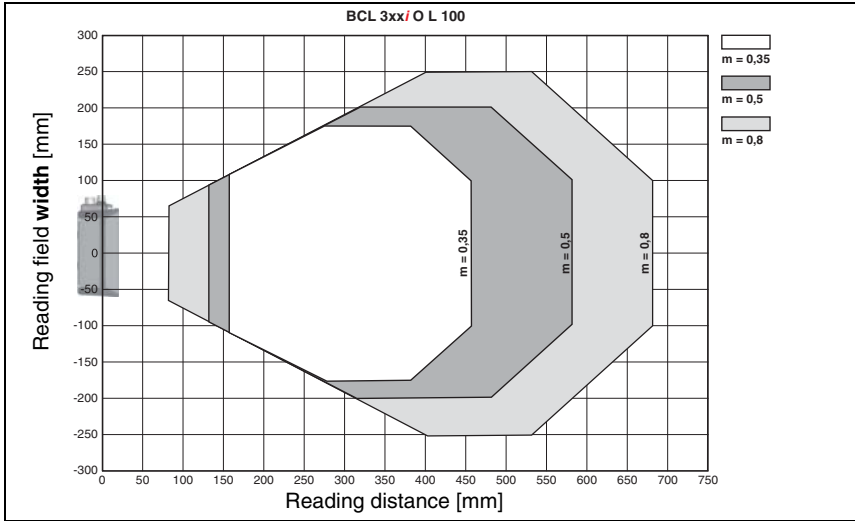


Figure 5.21: "Ultra Low Density" reading field curve for oscillating-mirror scanners

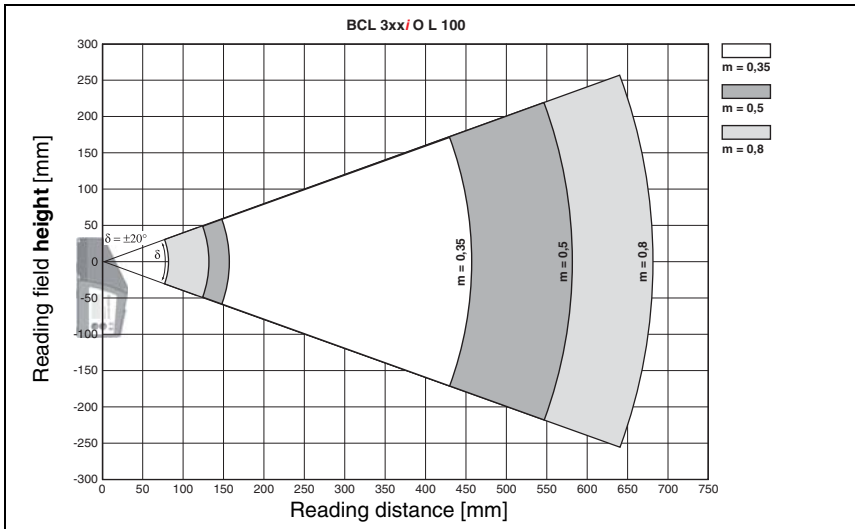


Figure 5.22: Lateral "Ultra Low Density" reading field curve for oscillating-mirror scanners

The reading field curves apply for the reading conditions stated in Table 5.8.

5.5.12 Ink Jet (J) - optics: BCL 338i R1 J 100

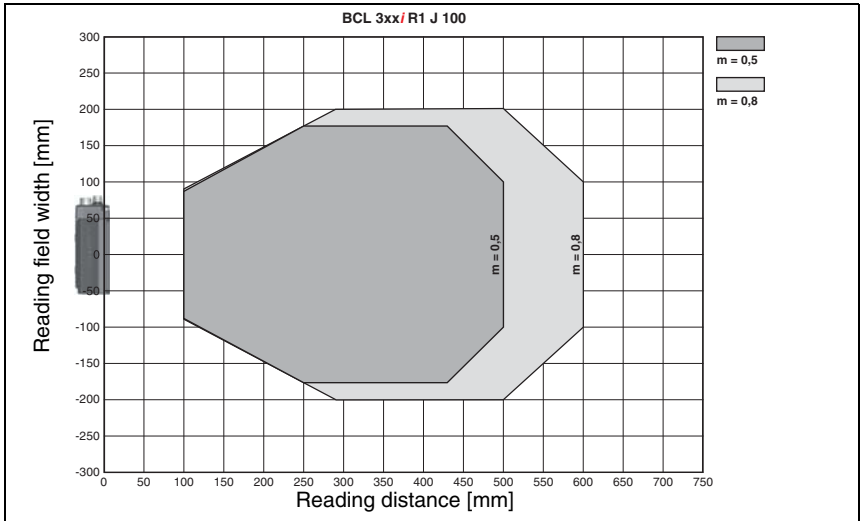


Figure 5.23: "Ink Jet" reading field curve for line scanner with deflecting mirror



Note!

Please note that the real reading distances are also influenced by factors such as labeling material, printing quality, scanning angle, printing contrast, etc., and may thus deviate from the reading distances specified here.

Due to the shape of the optical laser spot, the CRT function may exhibit limitations (max. permissible tilt angle of $\pm 15^\circ$).

Low-contrast bar codes that are printed with inkjet should be sent to Leuze electronic for examination.

6 Installation and mounting

6.1 Storage, transportation



Attention!

Package the device for transport and storage in such a way that is protected against shock and humidity. Optimum protection is achieved when using the original packaging. Ensure compliance with the approved environmental conditions listed in the specifications.

Unpacking

- ✎ Check the packaging content for any damage. If damage is found, notify the post office or shipping agent as well as the supplier.
- ✎ Check the delivery contents using your order and the delivery papers:
 - Delivered quantity
 - Device type and model as indicated on the name plate
 - Laser warning signs
 - Brief manual

The name plate provides information as to what BCL type your device is. For specific information, please refer to Chapter 5.

Name plates of the bar code readers of the BCL 338i series

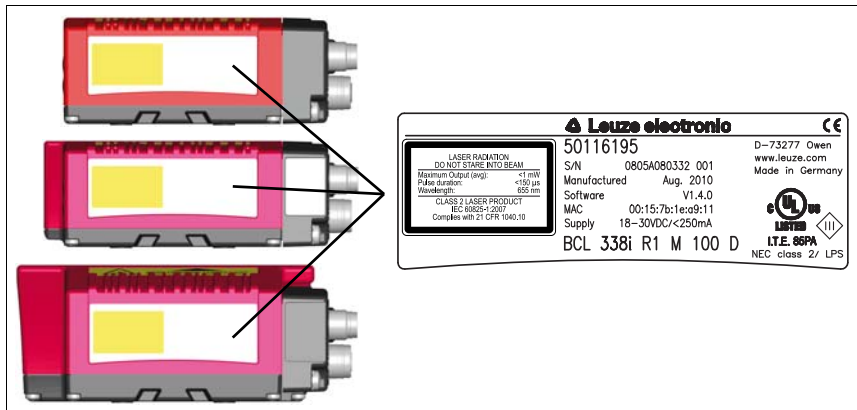


Figure 6.1: Device name plate BCL 338i

- ✎ Save the original packaging for later storage or shipping.



Note!

All BCL 338i are delivered with a protective cover on the connection side which must be removed before attaching a connection hood.

If you have any questions concerning your shipment, please contact your supplier or your local Leuze electronic sales office.

↳ *Observe the applicable local regulations when disposing of the packaging materials.*

6.2 Mounting the BCL 338i

The BCL 338i bar code readers can be mounted in different ways:

- Via four or six M4x5 screws on the device bottom.
- Via a BT 56/BT 59 mounting device in the two fastening grooves on the device bottom.



Attention!

The BCL 338i does not fulfill degree of protection IP 65 until the connection hood has been screwed on. Minimum tightening torque of the housing connecting screw of the connection hood is 1.4Nm!

6.2.1 Mounting via M4 x 5 screws

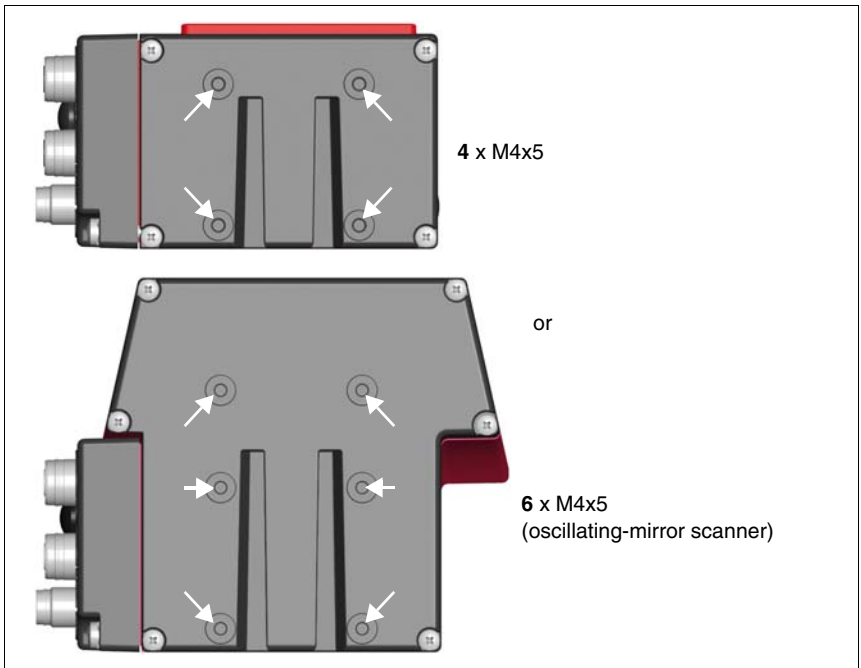


Figure 6.2: Fastening options using M4x5 threaded holes

6.2.2 BT 56 mounting device

The BT 56 mounting device is available for mounting the BCL 338*i* using the fastening grooves. It is designed for rod mounting (\varnothing 16 mm to 20 mm). For order guide, please refer to chapter "Type overview and accessories" on page 175.

BT 56 mounting device

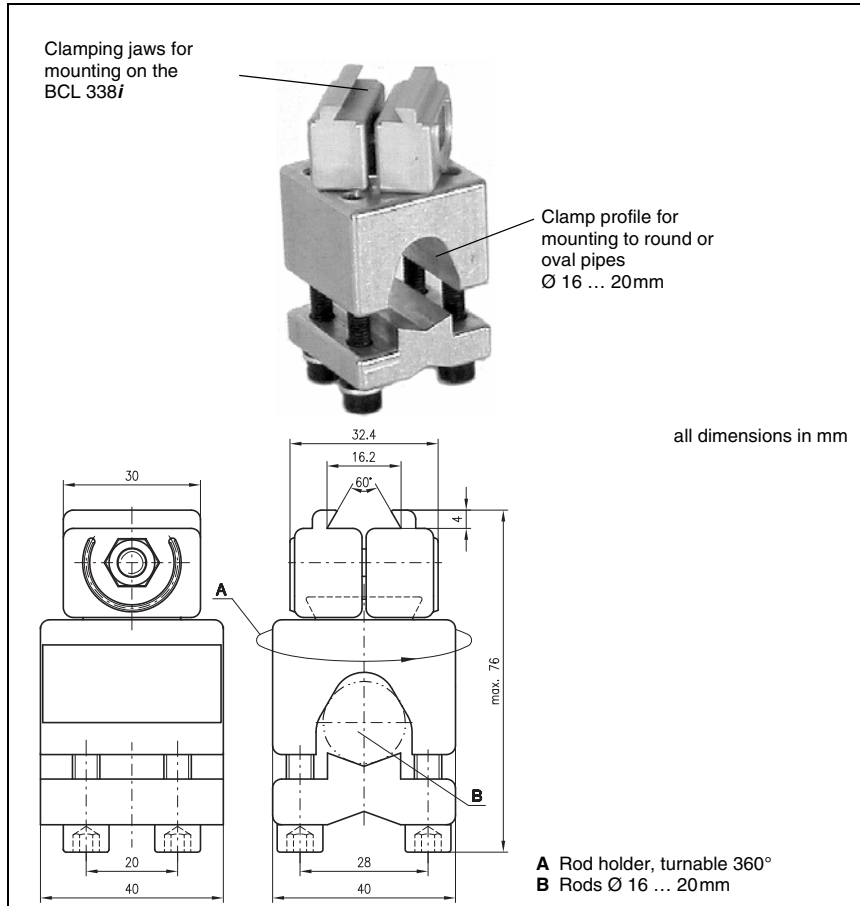


Figure 6.3: BT 56 mounting device

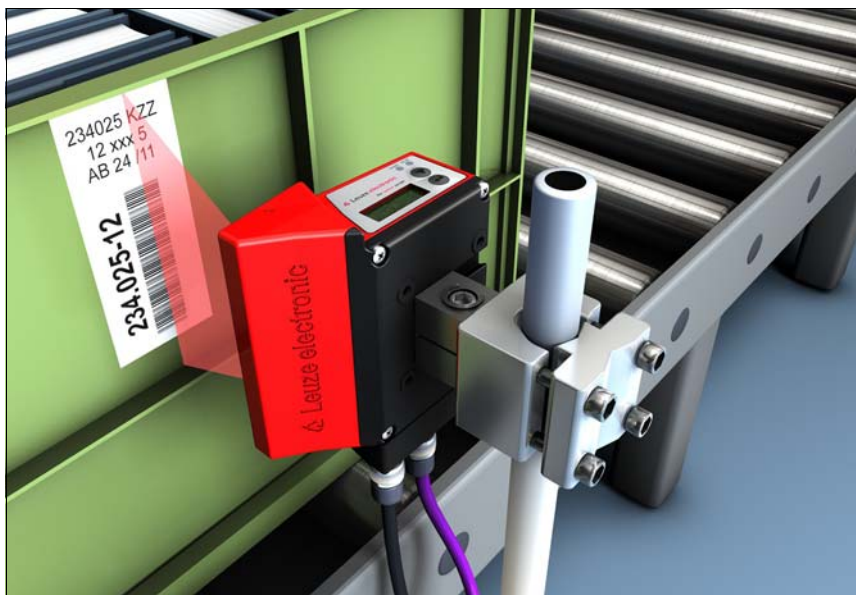


Figure 6.4: Mounting example of BCL 338*i* with BT 56

6.2.3 BT 59 mounting device

The BT 59 mounting device offers you an additional fastening option. For order guide, please refer to chapter "Type overview and accessories" on page 175.

BT 59 mounting device

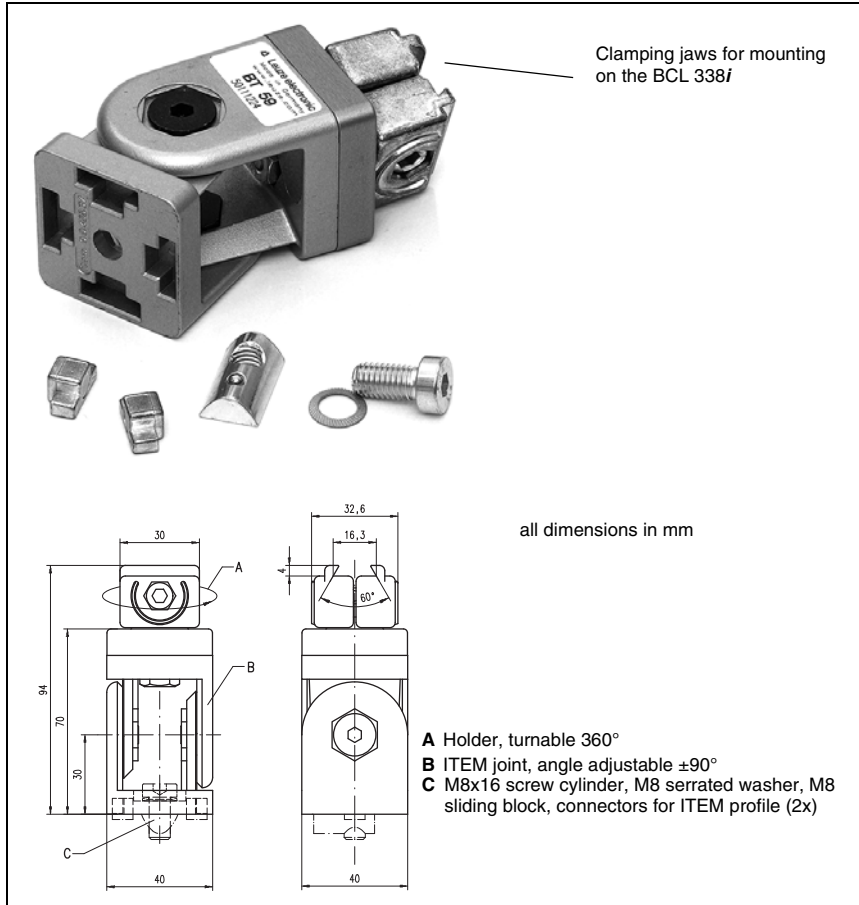


Figure 6.5: BT 59 mounting device



Note!

When mounting, ensure that the scanning beam is not reflected directly back to the scanner by the label which is being read. For further information, see the notices in Chapter 6.3! Please refer to Chapter 5.4 for the permissible minimum and maximum distances between the BCL 338i and the labels to be read.

**Note!**

When mounting, ensure that the scanning beam is not reflected directly back to the scanner by the label which is being read. For further information, see the notices in Chapter 6.3! Please refer to Chapter 5.4 for the permissible minimum and maximum distances between the BCL 338i and the labels to be read.

6.3 Device arrangement

6.3.1 Selecting a mounting location

In order to select the right mounting location, several factors must be considered:

- Size, orientation, and position tolerance of the bar codes on the objects to be scanned.
- The reading field of the BCL 338i in relation to the bar code module width.
- The resulting minimum and maximum reading distance from the respective reading field (see chapter 5.4 "Reading field curves / optical data").
- The permissible cable lengths between the BCL 338i and the host system depending on which interface is used.
- The correct time for data output. The BCL 338i should be positioned in such a way that, taking into consideration the time required for data processing and the conveyor belt speed, there is sufficient time to e.g. initiate sorting operations on the basis of the read data.
- The display elements such as LEDs or the display should be highly visible.
- For configuring and commissioning with the webConfig tool, the USB interface should be easily accessible.

For specific information, please refer to Chapter 6.

**Note!**

The beam of the BCL 338i exits:

- **Parallel** to the **housing base** in the case of the line scanner
- **At 105 degrees** from the **housing base** in the case of the deflecting mirror
- **Perpendicular** to the **housing base** in the case of the oscillating mirror

In each case, the housing base is the black area in Figure 6.2. The best read results are obtained when:

- The BCL 338i is mounted in such a way that the scanning beam is incident on the bar code at an angle of inclination greater than $\pm 10^\circ$... 15° to vertical.
- The reading distance lies in the middle area of the reading field.
- The bar code labels are of good print quality and have good contrast ratios.
- You do not use high-gloss labels.
- There is no direct sunlight.

6.3.2 Avoiding total reflection – Line scanner

The bar code label must be positioned at an angle of inclination greater than $\pm 10^\circ \dots 15^\circ$ from vertical in order to avoid total reflection of the laser beam (see Figure 6.7)!

Total reflection occurs whenever the laser light of the bar code reader is directly incident on the surface of the bar code at an angle of 90° . The light directly reflected by the bar code may overload the bar code reader and thereby cause non-readings!

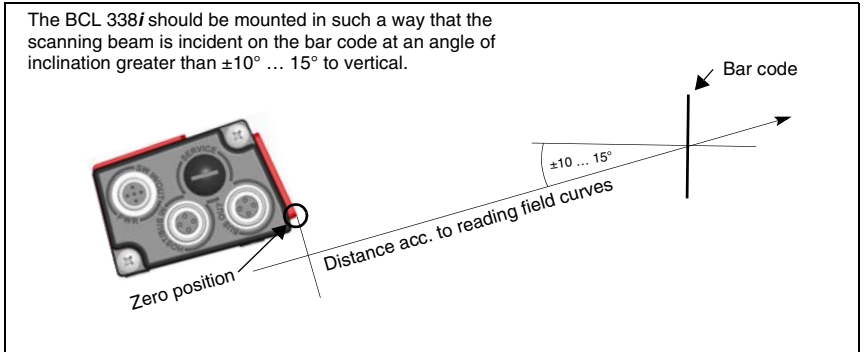


Figure 6.7: Total reflection – line scanner

6.3.3 Avoiding total reflection – deflecting mirror scanner

For the BCL 338*i* with **deflecting mirror**, the laser beam exits at an angle of 105° to the rear housing wall.

An angle of incidence of 15° of the laser to the label has already been integrated in the deflecting mirror so that the BCL 338*i* can be installed parallel to the bar code (rear housing wall).

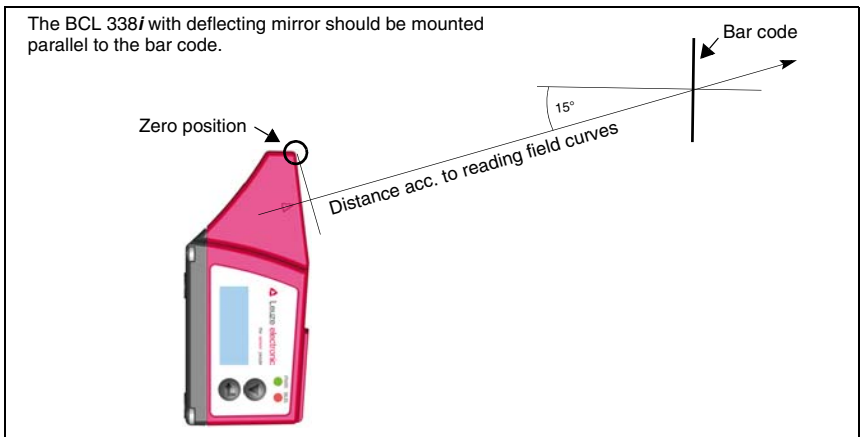


Figure 6.8: Total reflection – line scanner

6.3.4 Avoiding total reflection – oscillating-mirror scanner

For the BCL 338*i* with **oscillating mirror**, the laser beam exits at an **angle of 90° to vertical**.

For the BCL 338*i* with **oscillating mirror**, the **swivel range of ±20°** (±12° for devices with heating) **is to be taken into account**.

This means that in order to be on the safe side and to avoid total reflection, the BCL 338*i* with oscillating mirror must be inclined upward or downward 20° ... 30°!



Note!

Mount the BCL 338*i* with oscillating mirror in such a way that the exit window of the bar code reader is parallel to the object. This will result in an angle of inclination of approx. 25°.

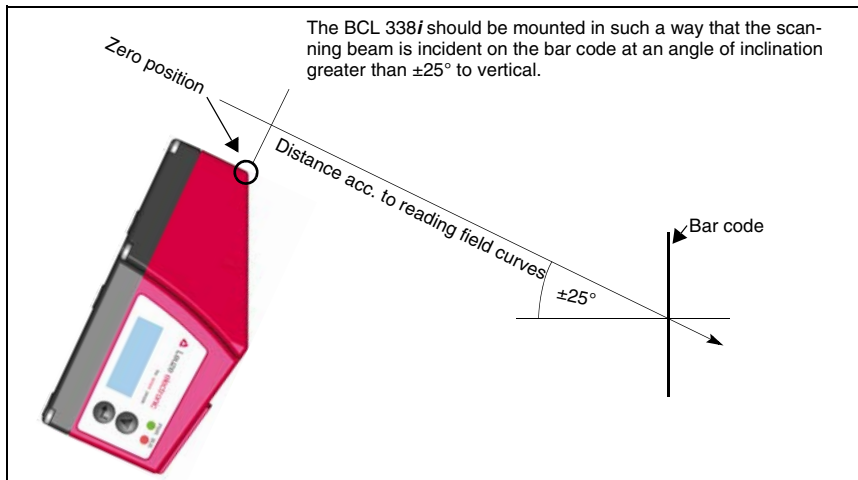


Figure 6.9: Total reflection – BCL 338*i* with oscillating-mirror scanner

6.3.5 Mounting location

↳ When choosing the mounting location, observe the following:

- Maintaining the required environmental conditions (temperature, humidity).
- Possible soiling of the reading window due to liquids, abrasion by boxes, or packaging material residues.
- Lowest possible chance of damage to the BCL 338*i* by mechanical collision or jammed parts.
- Possible extraneous light (no direct sunlight or sunlight reflected by the bar code).

6.3.6 Devices with integrated heating

↳ When mounting devices with integrated heating, also observe the following points:

- Mount the BCL 338*i* in a way which provides maximum thermal isolation, e.g. using rubber-bonded metal.
- Mount in such a way that the device is protected from draft and wind; mount additional shields if necessary.



Note!

When installing the BCL 338*i* in a protective housing, it must be ensured that the scanning beam can exit the protective housing without obstruction.

6.3.7 Possible read angles between BCL 338*i* and bar code

The optimum alignment of the BCL 338*i* is accomplished when the scan line scans the bar code bars almost at a right angle (90°). All reading angles that are possible between the scan line and bar code must be taken account (Figure 6.10).

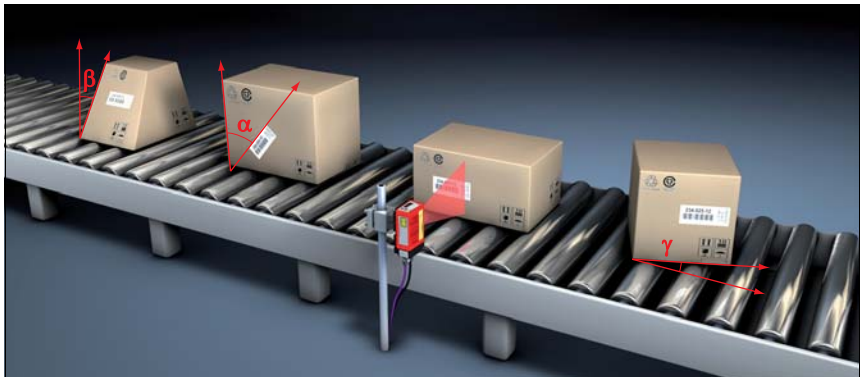


Figure 6.10: Reading angle for the line scanner

- α Azimuth angle (tilt)
- β Inclination angle (pitch)
- γ Angle of rotation (skew)

In order to avoid total reflection, the skew γ should be greater than 10°

6.4 Cleaning

- ↳ Clean the glass window of the BCL 338i with a soft cloth after mounting. Remove all packaging remains, e.g. carton fibers or styrofoam balls. In doing so, avoid leaving fingerprints on the front screen of the BCL 338i.



Attention!

Do not use aggressive cleaning agents such as thinner or acetone for cleaning the device.

7 Electrical connection

The bar code readers of the BCL 300i series feature a modular connection concept with interchangeable connection hoods.

The additional Mini-B type USB interface is used for configuring the device.



Note!

On delivery, the products are provided with a plastic protective cap on the side of the system plug or the system socket.

Additional connection accessories can be found in Chapter 14.



Attention!

The BCL 338i does not fulfill degree of protection IP 65 until the connection hood has been screwed on. Minimum tightening torque of the housing connecting screw of the connection hood is 1.4Nm!

Location of the electrical connections

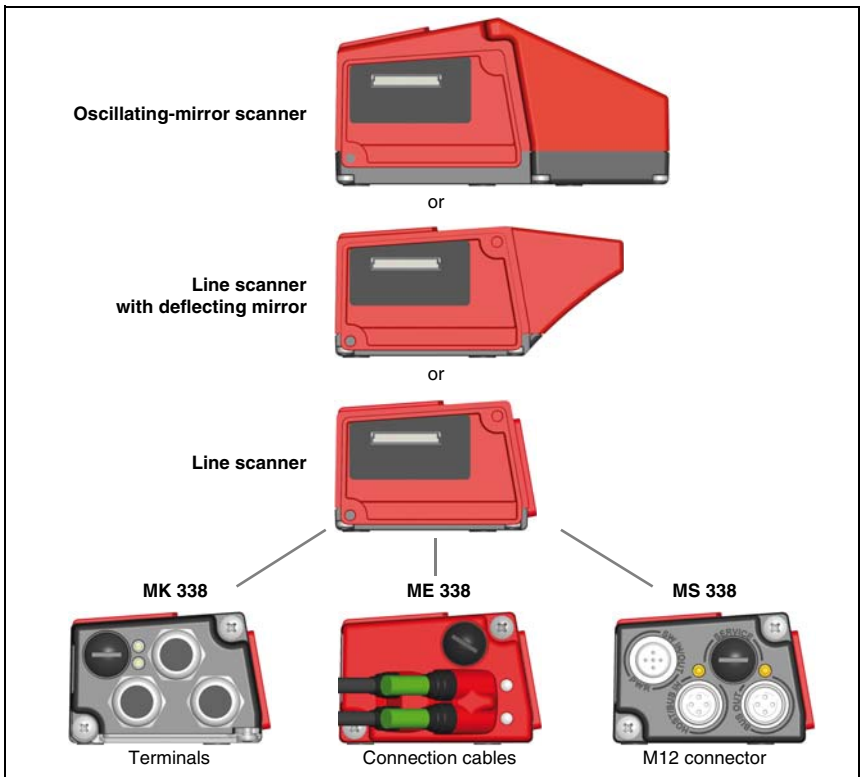


Figure 7.1: Location of the electrical connections

7.1 Safety notices for the electrical connection

**Attention!**

Do not open the device yourself under any circumstances! There is otherwise a risk of uncontrolled emission of laser radiation from the device. The housing of the BCL 338i contains no parts that need to be adjusted or maintained by the user.

Before connecting the device, be sure that the supply voltage agrees with the value printed on the name plate.

Connection of the device and cleaning must only be carried out by a qualified electrician.

Ensure that the functional earth (FE) is connected correctly. Unimpaired operation is only guaranteed when the functional earth is connected properly.

If faults cannot be cleared, the device should be switched off and protected against accidental use.

**Attention!**

For UL applications, use is only permitted in Class 2 circuits in accordance with the NEC (National Electric Code).



The bar code readers of the BCL 300i series are designed in accordance with protection class III for supply by PELV (protective extra-low voltage with reliable disconnection).

**Note!**

Degree of protection IP 65 is not fulfilled until connectors or cable bushings are screwed on and caps are installed.

**Attention!**

To ensure degree of protection IP 65 is fulfilled, the screws of the connection hood are tightened with a tightening torque of 1.4 Nm for connecting to the BCL.

7.2 BCL 338*i* electrical connection

For the electrical connection of the BCL 338*i*, 3 connection variants are available.

The **voltage supply** (18 ... 30VDC) is connected acc. to the connection type selected.

2 freely programmable switching inputs/outputs for individual adaptation to the respective application are also available here. Detailed information on this topic can be found in Chapter 7.3.1.

7.2.1 MS 338 connector hood with 3 integrated M12 connectors

The MS 338 connector hood features three M12 connector plugs and a Mini-B type USB socket as a service interface. Parameter memory is integrated into the MS 338 which temporarily stores the settings of the BCL 338*i* in the case of replacement and transmits them to a new device.

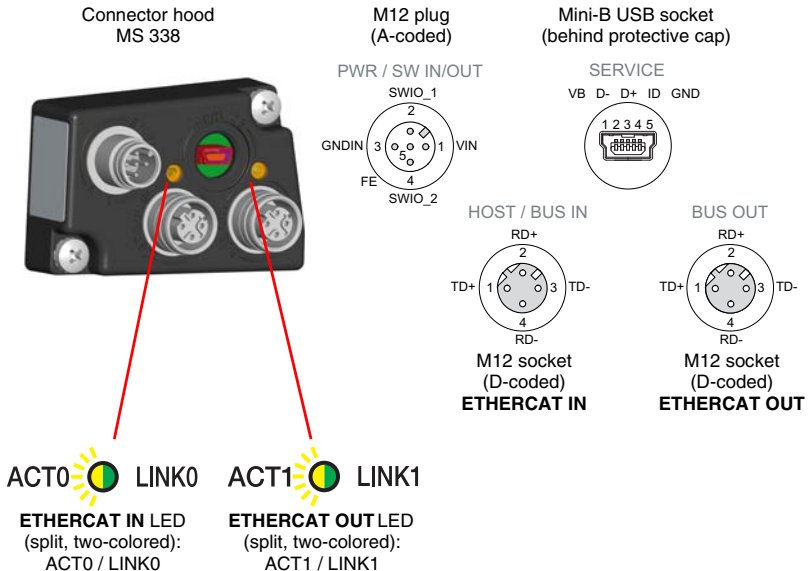


Figure 7.2: BCL 338*i* - MS 338 connection hood with M12 connectors



Note!

The shielding connection is done via the M12 connector housing.



Note!

The integrated parameter memory for the simple replacement of the BCL 338*i* is located in the MS 338. In the integrated parameter memory, both the settings and the network address are saved and transmitted to a new device.



Note!

In the case of EtherCAT line topology, the network is interrupted when the BCL 338i is removed from the MS 338.



Note!

Dimensioned drawing on see chapter 5.3.5 "Dimensioned drawings of MS 3xx / ME 3xx / MK 3xx connection hoods" on Page 49.

7.2.2 ME 338 103 connection hood with M12 connection cables

The ME 338 103 connection hood features three connection cables with M12 connectors and a Mini-B type USB socket as service interface. Parameter memory is integrated into the ME 338 103 which temporarily stores the settings of the BCL 338f in the case of replacement and transmits them to a new device.

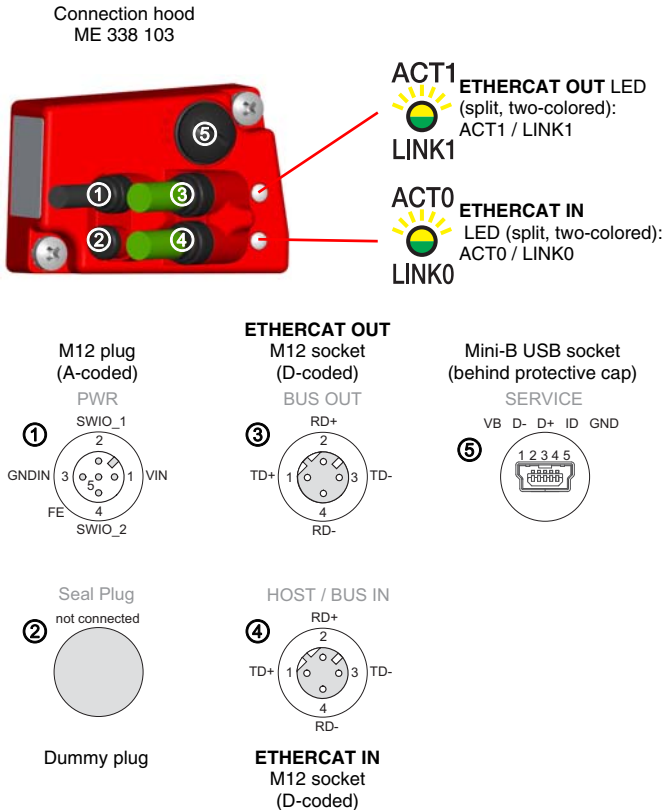


Figure 7.3: BCL 338i - ME 338 103 connection hood with M12 connection cables

**Note!**

The shielding connection is done via the M12 connector housing.

**Note!**

The integrated parameter memory for the simple replacement of the BCL 338i is located in the ME 338 103. In the integrated parameter memory, both the settings and the network address are saved and transmitted to a new device.

**Note!**

In the case of EtherCAT line topology, the network is interrupted when the BCL 338i is removed from the ME 338 103.

**Note!**

Dimensioned drawing on see chapter 5.3.5 "Dimensioned drawings of MS 3xx / ME 3xx / MK 3xx connection hoods" on Page 49.

7.2.3 ME 338 104 connection hood with M8/M12 connection cables

The ME 338 104 connector hood features three connection cables with M12 connectors, a connection cable with M8 connectors and a Mini-B type USB socket as service interface. Parameter memory is integrated into the ME 338 104 which temporarily stores the settings of the BCL 338*i* in the case of replacement and transmits them to a new device.

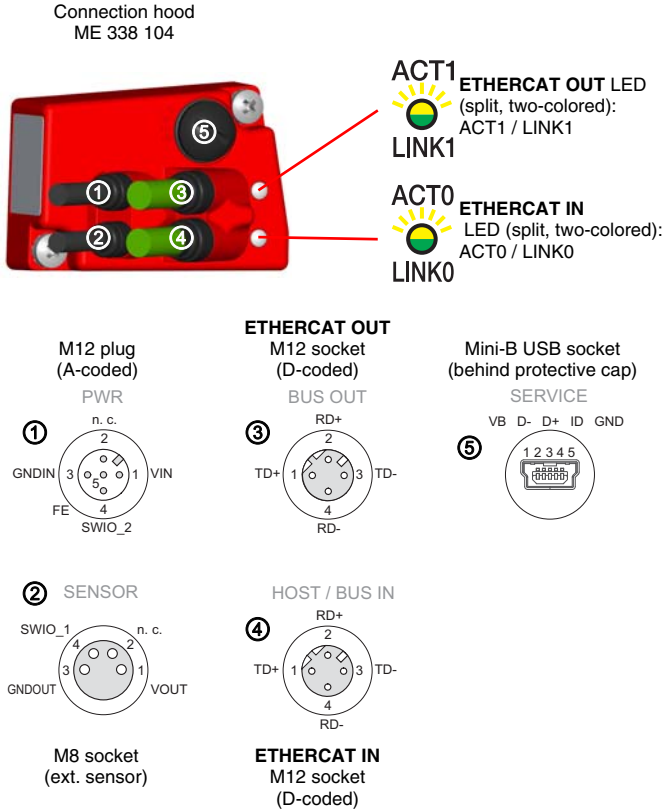


Figure 7.4: BCL 338*i* - ME 338 104 connection hood with M8/M12 connection cables



Note!

The shielding connection is done via the M12 connector housing.



Note!

The integrated parameter memory for the simple replacement of the BCL 338*i* is located in the ME 338 104. In the integrated parameter memory, both the settings and the network address are saved and transmitted to a new device.



Note!

In the case of EtherCAT line topology, the network is interrupted when the BCL 338i is removed from the ME 338 104.



Note!

Dimensioned drawing on see chapter 5.3.5 "Dimensioned drawings of MS 3xx / ME 3xx / MK 3xx connection hoods" on Page 49.

7.2.4 ME 338 214 connection hood with M8/M12/RJ45 connection cables

The ME 338 214 connector hood features a connection cable with M12 connectors, two connection cables with RJ45 sockets, a connection cable with M8 connectors and a Mini-B type USB socket as service interface. Parameter memory is integrated into the ME 338 214 which temporarily stores the settings of the BCL 338i in the case of replacement and transmits them to a new device.

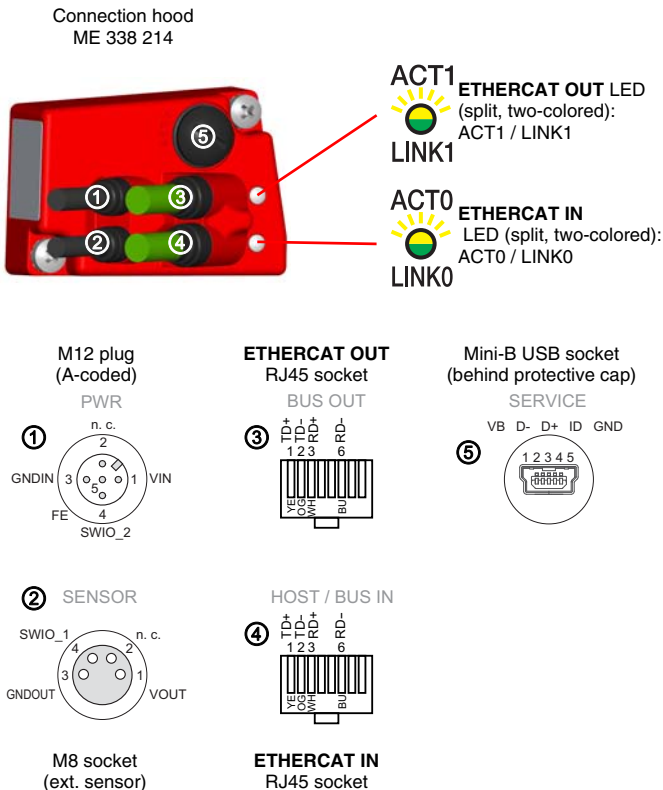


Figure 7.5: BCL 338i - ME 338 214 connection hood with M8/M12/RJ45 connection cables



Note!

The shielding connection is done via the M12 connector housing.



Note!

The integrated parameter memory for the simple replacement of the BCL 338*i* is located in the ME 338 214. In the integrated parameter memory, both the settings and the network address are saved and transmitted to a new device.



Note!

In the case of EtherCAT line topology, the network is interrupted when the BCL 338*i* is removed from the ME 338 214.



Note!

Dimensioned drawing on see chapter 5.3.5 "Dimensioned drawings of MS 3xx / ME 3xx / MK 3xx connection hoods" on Page 49.

7.2.5 MK 338 terminal hood with spring-cage terminals

The MK 338 terminal hood makes it possible to connect the BCL 338*i* directly and without additional connectors. The MK 338 features three cable bushings in which the shielding when the MK 338 is in a closed state via a Mini-B type USB socket functioning as the service interface. Parameter memory is integrated into the MK 338 which temporarily stores the settings of the BCL 338*i* in the case of replacement and transmits them to a new device.

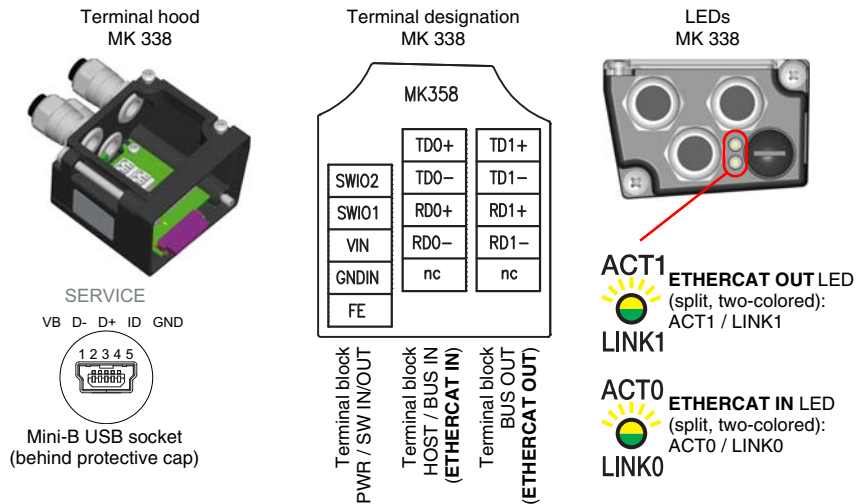


Figure 7.6: BCL 338*i* - MK 338 terminal hood with spring-cage terminals



Note!

The integrated parameter memory for the simple replacement of the BCL 338i is located in the MK 338. In the integrated parameter memory, both the settings and the network address are saved and transmitted to a new device.



Note!

In the case of EtherCAT line topology, the network is interrupted when the BCL 338i is removed from the MK 338.

Cable fabrication and shielding connection

Remove approx. 78 mm of the connection cable sheathing. 15 mm of sheath of the shielded line must be freely accessible.

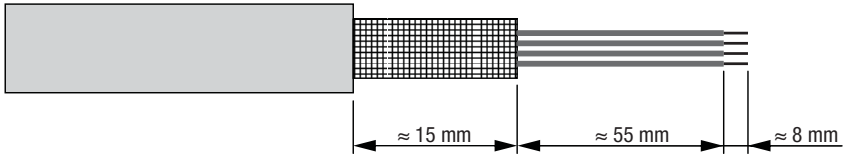


Figure 7.7: Cable fabrication for MK 338 terminal hood

The shield is automatically contacted when the cable is lead into the metal screw fitting and fastened when the cord grip is closed. Then lead the individual wires into the terminals according to the diagram. Wire end sleeves are not necessary.



Note!

Dimensioned drawing on see chapter 5.3.5 "Dimensioned drawings of MS 3xx / ME 3xx / MK 3xx connection hoods" on Page 49.

7.3 Detailed description of the connections

Described in detail in the following are the individual connections and pin assignments.

7.3.1 PWR / SW IN/OUT - Voltage supply and switching input/output 1 and 2

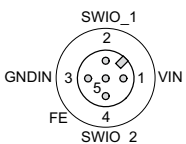

PWR / SW IN/OUT			
MS/ME 338... PWR / SW IN/OUT	Pin (M12)	Name (terminal)	Comment
 <p>M12 plug (A-coded)</p>  <p>MK 338 Spring-cage terminals</p>	1	VIN	Positive supply voltage +18 ... +30VDC
	2	SWIO_1 (n. c.) ¹⁾	Configurable switching input/output 1 ¹⁾
	3	GNDIN	Negative supply voltage 0VDC
	4	SWIO_2	Configurable switching input/output 2
	5	FE	Functional earth
	Thread	FE	Functional earth (housing)

Table 7.1: PWR / SW IN/OUT pin assignment

- 1) With the ME 338 104 and the ME 338 214, this pin is not connected (n.c.). With the connection hoods, SWIO 1 is available on the M8 connector for the direct connection of an external sensor (see Chapter 7.3.2)

Supply voltage

Attention!



For UL applications, use is only permitted in Class 2 circuits in accordance with the NEC (National Electric Code).



The bar code readers of the BCL 300i ... series are designed in accordance with protection class III for supply by PELV (protective extra-low voltage with reliable disconnection).

Connecting the functional earth FE

↳ Ensure that the functional earth (FE) is connected correctly. Unimpaired operation is only guaranteed when the functional earth is connected properly. All electrical disturbances (EMC couplings) are discharged via the functional earth connection.

Switching input/output

The bar code readers of the BCL 300*i* series are equipped with two freely programmable, opto-decoupled switching inputs and outputs, **SWIO_1** and **SWIO_2**.

The switching inputs can be used to activate various internal functions of the BCL 338*i* (decoding, autoConfig, ...). The switching outputs can be used to signal the state of the BCL 338*i* and to implement external functions independent of the superior control.



Note!

The respective function as input or output can be set with the aid of the webConfig configuration tool!

Described in the following is the external wiring for use as a switching input or output; the respective function assignments to the switching inputs/outputs can be found in Chapter 10.

Function as switching input

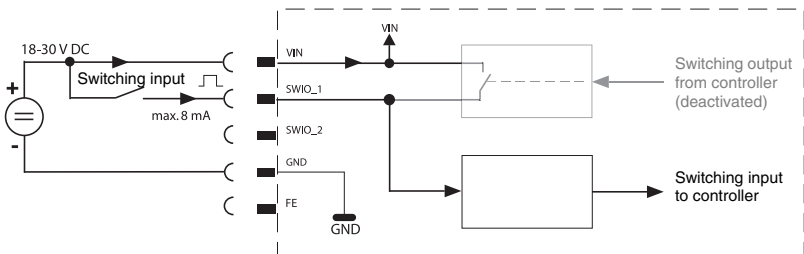


Figure 7.1: Switching input connection diagram SWIO_1 and SWIO_2

If you use a sensor with a standard M12 connector, please note the following:

- Pins 2 and 4 must not be operated as switching outputs if sensors which function as inputs are also connected to these pins.

If, for example, the inverted sensor output is connected to pin 2, and pin 2 of the bar code reader is, at the same time, configured as an output (and not as an input), the switching output malfunctions.



Attention!

The maximum input current must not exceed 8 mA!

Function as switching output

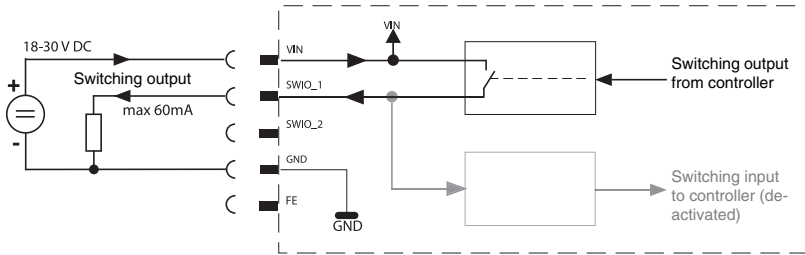


Figure 7.2: Switching output connection diagram SWIO_1 / SWIO_2



Attention!

Each configured switching output is short-circuit proof! Do not load the respective switching output of the BCL 338i with more than 60mA at +18 ... +30 VDC in normal operation!



Note!

Both switching inputs/outputs SWIO_1 and SWIO_2 are configured by default in such a way that:

- Switching input SWIO_1 activates the reading gate.
- Switching output SWIO_2 switches by default on "No Read."

7.3.2 SENSOR - direct connection of an external sensor (ME 338 xx4 only)

Connection hoods ME 338 104 and ME 338 214 are equipped with an M8 connection cable for the direct connection of an external sensor (e.g., a trigger sensor)

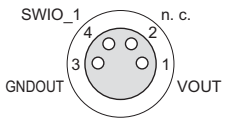
PWR / SW IN/OUT			
	Pin (M8)	Name (terminal)	Comment
<p>ME 338 104 ME 338 214</p> <p>SENSOR</p>  <p>M8 socket</p>	1	VOUT	Positive supply voltage for ext. sensor +18 ... +30VDC
	2	n.c.	Not assigned
	3	GNDOUT	Negative supply voltage for ext. sensor 0VDC
	4	SWIO_1	Configurable switching input/output 1
	Thread	FE	Functional earth (housing)

Table 7.2: SENSOR pin assignment

7.3.3 SERVICE – USB interface (Mini-B type)


SERVICE – USB interface (Mini-B type)			
	Pin (USB Mini-B)	Name	Comment
<p>SERVICE</p> <p>VB D- D+ ID GND</p> 	1	VB	Sense input
	2	D-	Data -
	3	D+	Data +
	4	ID	Not connected
	5	GND	Ground

Table 7.3: SERVICE pin assignment – Mini-B type USB interface

⚡ Ensure adequate shielding.

The entire interconnection cable must absolutely be shielded acc. to the USB specifications. Cable length must not exceed 3 m.

⚡ Use the Leuze-specific **USB service cable** (see chapter 14 "Type overview and accessories") for the connection and use a service PC to configure.



Note!

IP 65 is achieved only if the connectors and caps are screwed into place.

7.3.4 HOST / BUS IN for BCL 338i

The BCL 338i makes an EtherCAT interface available as host interface.

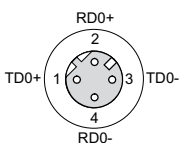
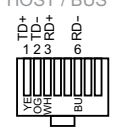

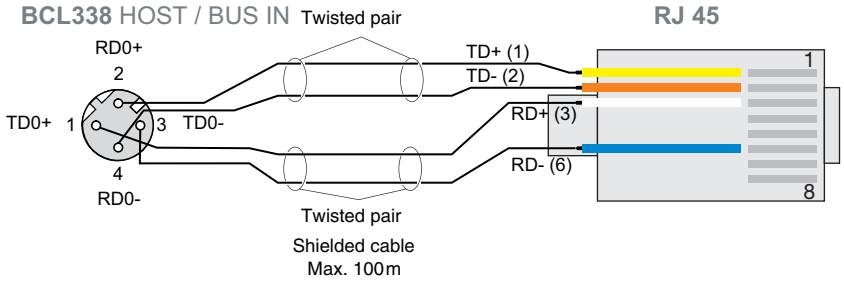
HOST / BUS IN (ETHERCAT IN)				
	Pin (M12)	Pin (RJ45)	Name (terminal)	Comment
<p>MS 338 ME 338 10x HOST / BUS IN</p>  <p>M12 socket (D-coded)</p> <p>ME 338 214 HOST / BUS IN</p>  <p>RJ45 socket</p> <p>MK 358</p>  <p>Spring-cage terminals</p>	1	1	TD0+	Transmit Data +
	2	3	RD0+	Receive Data +
	3	2	TD0-	Transmit Data -
	4	6	RD0-	Receive Data -
	FE via thread	FE via collar	FE via screw fitting	Functional earth (housing)

Table 7.4: Pin assignment HOST / BUS IN for BCL 338i

↳ For the host connection of the BCL 338i, the "KSS ET-M12-4A-RJ45-A-P7-..." ready-made cables are preferred, see Table 14.9 "Bus connection cables for the BCL 338i" on page 180.

Ethernet cable assignment



RJ45 - assignment and core colors

Pin	Signal	Name	Core color acc. to PROFINET	Core color acc. to EIA T568B
1	TD+	Transmission Data +	Yellow	White/orange
2	TD-	Transmission Data -	Orange	Orange
3	RD+	Receive Data +	White	White/Green
6	RD-	Receive Data -	Blue	Green

Figure 7.1: HOST / BUS IN cable assignments on RJ-45



Note for connecting the EtherCAT interface!

Ensure adequate shielding. The entire interconnection cable must be shielded and earthed. The RD+/RD- and TD+/TD- wires must be stranded in pairs. Use CAT 5 cables for the connection.

7.3.5 BUS OUT for the BCL 338i

To set up an EtherCAT network with other participants with linear topology, the BCL 338i makes available another Ethernet interface. The use of this interface drastically reduces the cabling requirements, as only the first BCL 338i requires a direct connection to the switch, via which it can communicate with the host. All other BCL 338i are connected in series to the first BCL 338i, see Figure 7.3.

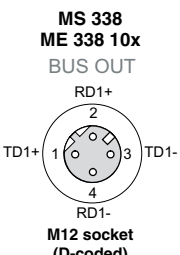
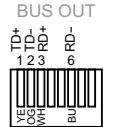
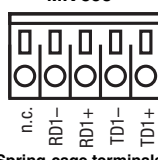
BUS OUT (ETHERCAT OUT)				
	Pin (M12)	Pin (RJ45)	Name (terminal)	Comment
 <p>MS 338 ME 338 10x BUS OUT</p> <p>RD1+ 2 1 TD1+ 3 TD1- 4 RD1-</p> <p>M12 socket (D-coded)</p>	1	1	TD1+	Transmit Data +
	2	3	RD1+	Receive Data +
	3	2	TD1-	Transmit Data -
	4	6	RD1-	Receive Data -
 <p>ME 338 214 BUS OUT</p> <p>TD+ RD+ RD- 1 2 3 6</p> <p>RJ45 socket</p>	FE via thread	FE via collar	FE via screw fitting	Functional earth (housing)
 <p>MK 358</p> <p>n.c. RD1- RD1+ TD1- TD1+</p> <p>Spring-cage terminals</p>				

Table 7.5: Pin assignment BUS OUT for BCL 338i

↳ For the connection of two BCL 338i, the "KSS ET-M12-4A-M12-4A-P7-..." ready-made cables are preferred, see Table 14.9 "Bus connection cables for the BCL 338i" on page 180.

If you use ready-made cables, note the following:



Note!

Ensure adequate shielding. The entire interconnection cable must be shielded and earthed. The signal lines must be stranded in pairs. Use CAT 5 cables for the connection.



Note!

For the BCL 338*i* as stand-alone device or as the last participant in a linear topology, termination on the BUS OUT socket is not mandatory!

7.4 EtherCAT topologies

EtherCAT permits a multitude of topologies such as line, tree, ring, star and combinations of these. The bus or line structure known from the fieldbuses is thus also available for EtherCAT.

Telegrams are sent on a wire pair in the "processing direction" from the master to the slave. The EtherCAT device processes the frames only in this direction and passes them on to the subsequent device until the telegram has passed through all devices. The last device sends the telegram back to the master on the second wire pair of the bus cable in the "forward direction". Here, the EtherCAT always forms a logical ring structure regardless of the topology installed.

From an Ethernet point of view, an EtherCAT bus segment is nothing more than a single, large Ethernet participant which sends and receives Ethernet telegrams. Within the "participant", however, there is a multitude of EtherCAT slaves rather than one single Ethernet controller.

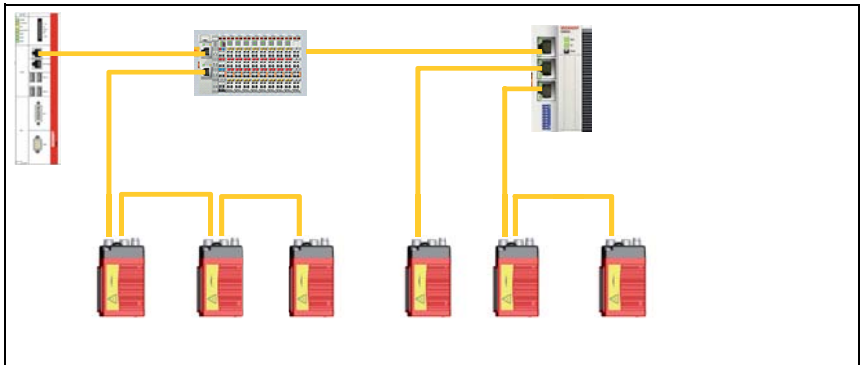


Bild 7.2: Topology example

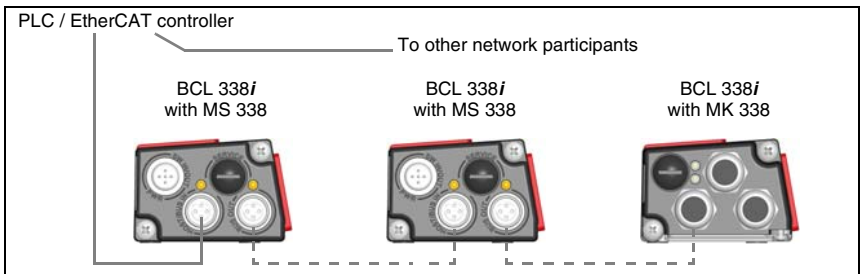


Figure 7.3: EtherCAT in a linear topology

Each participating BCL 338*i* is automatically assigned its address by a DHCP server. Alternatively, each BCL 338*i* can be assigned the respective network address via the webConfig tool.

Information on the necessary configuration steps can be found in Chapter 10 and Chapter 11.

7.4.1 EtherCAT wiring

A Cat. 5 Ethernet cable should be used for wiring.

Connection hood "ME 338 214" is available for the direct connection to the BCL 338*i*. It is equipped with 2 connection cables with RJ45 socket into which the standard network cables can be plugged.

If no standard network cables are to be used (e.g. due to lacking IP... degree of protection), you can use the "KS ET-M12-4A-P7-..." user-configurable cables on the BCL 338*i* (depending on the connection hood used), see Table 14.9 "Bus connection cables for the BCL 338*i*" on page 180.

The connection between the individual BCL 338*i* devices in a linear topology with M12 connection technology is performed with the "KSS ET-M12-4A-M12-4A-P7-..." cables, see Table 14.9 "Bus connection cables for the BCL 338*i*" on page 180.

For unavailable cable lengths, you can configure your cable yourself. When doing so, make certain that you connect **TDx+** on the M12 connector with **RD+** on the RJ-45 connector and **TDx-** on the M12 connector with **RD-** on the RJ-45 connector, respectively, etc.



Note!

Use the recommended plugs / sockets or the ready-made cables (see chapter 14 "Type overview and accessories").

7.5 Cable lengths and shielding

↳ Observe the following maximum cable lengths and shielding types:

Connection	Interface	Max. cable length	Shielding
BCL – service	USB	3m	Shielding absolutely necessary acc. to USB specifications
BCL – host	EtherCAT	100m	Shielding absolutely required
Network from the first BCL to the last BCL	EtherCAT	The maximum segment length must not exceed 100 m for 100Base-TX Twisted Pair (min. Cat. 5)	Shielding absolutely required
BCL – power supply unit		30m	Not necessary
Switching input		10 m	Not necessary
Switching output		10 m	Not necessary

Table 7.6: Cable lengths and shielding

8 Display elements and display

The BCL 338*i* is available optionally with display, 2 control buttons and LEDs or with only 2 LEDs as display elements.

8.1 BCL 338*i* LED indicators



Figure 8.1: BCL 338*i* - LED indicators

2 multicolor LEDs are used as the primary display instrument.

LED functions:

PWR LED

PWR



off

Device OFF

- No supply voltage

PWR



green, flashing

Device ok, initialization phase

- No bar code reading possible
- Voltage connected
- Self test runs for 0.25s after power up
- Initialization running

PWR



green, continuous light

Device ok

- Bar code reading possible
- Self test successfully finished
- Device monitoring active

PWR



green, briefly off - on

Good read, successful reading

- Bar code(s) successfully read

PWR



green, briefly off - briefly red - on

No read, reading not successful

- Bar code(s) not read

PWR



orange, continuous light

Service mode

- Bar code reading possible
- Configuration via the USB service interface
- No data on the host interface

PWR



red, flashing

Warning set

- Bar code reading possible
- Self test runs for 0.25s after power up
- Temporary operating fault

PWR



red, continuous light

Device error

- No bar code reading possible

NET LED

NET



off

Device OFF, no supply voltage, EtherCAT communication not initialized or inactive

NET



flashing green, steady flashing

Device status: PRE-OPERATIONAL

NET



green, flashing, single flash

Device status: SAFE-OPERATIONAL

NET



green, continuous light

Device status: OPERATIONAL

NET



flashing red, steady flashing

**Faulty configuration,
device status: PRE-OPERATIONAL**

NET



red, flashing, single flash

**Local error,
e.g., synchronization error**

NET



red, flashing, double flash

**Process Data Watchdog Timeout or
EtherCAT Watchdog Timeout or
Sync Manager Watchdog Timeout**

NET



red, continuous light

**Bus error,
no communication established
to master**

8.2 MS 338/ME 338.../MK338 LED indicators

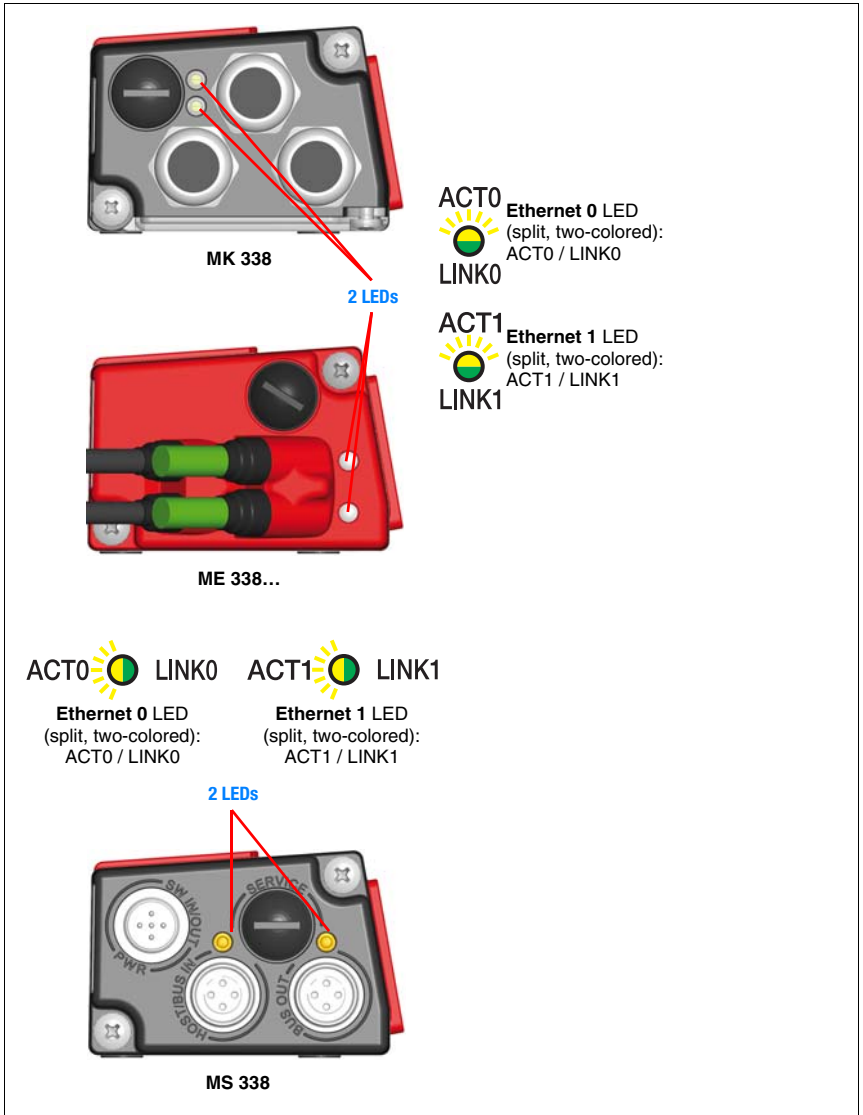


Figure 8.2: MS 338/ME 338.../MK 338 - LED indicators

As a status display for the two EtherCAT connections, **Ethernet_0** and **Ethernet_1**, there are two split two-colored LEDs each in the MS 338, ME 338... and MK 338:

ACT0 / LINK0 LED



green, continuous light
yellow, flashing

EtherCAT connected (LINK)
Data communication (ACT)

ACT1 / LINK1 LED



green, continuous light
yellow, flashing

EtherCAT connected (LINK)
Data communication (ACT)

8.3 BCL 338i display



Figure 8.3: BCL 338i - Display



Note!

The function of the LEDs is identical for the devices with and without display.

The optional display of the BCL 338i has the following features:

- Monochromatic with background lighting (blue/white)
- Double line, 128 x 32 pixels
- Display language: English

The display is only used as a **display element**. Two buttons can control which values are displayed. In doing so, the upper line displays the selected function and the lower line displays the result.

The background lighting is activated by the push of any button and automatically deactivated after a defined point in time:

Display functions

The following functions can be displayed and activated:

- *Reading result* = result of reading process
- *Decodequality* = quality of decoding process
- *BCL Info* = device status/error code
- *I/O Status* = status of the inputs/outputs
- *BCL Address* = IP address of the BCL 358i
- *Adjustmode* = alignment mode
- *Version* = software and hardware version

After the voltage is switched off/on, the *reading result* is always displayed.

The display is controlled via the two control buttons:



ENTER

Activation/deactivation of the display change function








Down

Scroll through functions (downwards)

Example:

Representation of the `BUS status` on the display:

1. Press button  : Display flashes
2. Press button  : Display changes from read result to decoding quality
3. Press button  : Display changes from decoding quality to device status
4. Press button  : Display changes from device status to BUS status
5. Press button  : Bus status displayed, display stops flashing.

Description of the display functions

```
Reading result
88776655
```

- 1st line: **read result** display function
- 2nd line: code content of the bar code, e.g. **88776655**

```
Decoding quality
84
```

- 1st line: **decoding quality** display function
- 2nd line: decoding quality in percent, e.g. **84%**

```
BCL info
Error code 3201
```

- 1st line: **device status** display function
- 2nd line: error code, e.g. **Error code 3201**

```
I/O status
In = 0 Out = 1
```

- 1st line: input/output **status** display function
- 2nd line: state: 0 = inactive, 1 = active, e.g. **In=0, Out=1**

```
BCL address
192.168.060.0
```

- 1st line: **IP address** display function
- 2nd line: set address, e.g. **192.168.060.0**

```
Adjust mode
73
```

- 1st line: **alignment mode** display function
- 2nd line: decoding quality in percent, e.g. **73%**

```
Version
SW:xxxxx HW:xxx
```

- 1st line: **version** display function
- 2nd line: software and hardware version of the device

9 Leuze webConfig tool

With the **Leuze webConfig tool**, an operating-system independent, web-technology based, graphical user interface is available for configuring bar code readers of the BCL 300*f* series. Through the use of HTTP as communication protocol and by using only standard technologies on the client side (HTML, JavaScript and AJAX), which are supported by all commonly used, modern browsers (e.g. **Mozilla Firefox** beginning with Version 4.0 or **Internet Explorer** beginning with Version 8.0 or **Microsoft Edge**), it is possible to operate the **Leuze webConfig tool** on any internet-ready PC.



Note!

The webConfig tool is offered in 6 languages:

- German
- English
- French
- Italian
- Spanish
- Chinese

9.1 Connecting the SERVICE USB interface

The connection to the SERVICE USB interface of the BCL 338*f* is established via the PC-side USB interface using a standard USB cable with 1 type A connector and a Mini-B type connector.



Figure 9.1: Connecting the SERVICE USB interface

9.2 Installing the required software

9.2.1 System requirements

Operating system:	Windows 2000 Windows XP (Home Edition, Professional) Windows Vista Windows 7 Windows 8 Windows 10
Computer:	PC with USB interface version 1.1 or higher
Graphics card:	Min. 1024 x 768 pixels or higher resolution
Required hard drive capacity:	Approx. 10MB



Note!

It is recommended to update the operating system and the browser regularly and to install the current Windows service packs.

9.2.2 Installing the USB driver




Note!

*If you have already installed a USB driver for a BCL 5xx*i* on your computer, you don't have to install the USB driver for the BCL 338*i*. In this case, you can also start the webConfig tool of the BCL 338*i* by double-clicking on the BCL 5xx*i* icon.*

In order for the BCL 338*i* to be automatically detected by the connected PC, the **USB driver** must be installed **once** on your PC. To do this, you must have **administrator privileges**.

Please proceed according to the following steps:

- ↳ Start your PC with administrator privileges and log on.
- ↳ Load the CD included in the delivery contents of your BCL 338*i* in the CD drive and start the setup.exe program.
- ↳ Alternatively, you can also download the setup program from the internet at www.leuze.com.
- ↳ Follow the instructions provided by the setup program.


Upon successful installation of the USB driver, an icon  with the name **Leuze Web Config** automatically appears on the desktop.



Note!

If the installation failed, contact your network administrator: The settings of the firewall used may need to be adjusted.

9.3 Starting the webConfig tool

To start the **webConfig tool**, click the icon  with the name **Leuze Web Config** located on the desktop. Make certain that the BCL 338*i* is connected to the PC via the USB interface and that voltage is connected. Alternatively, the **webConfig tool** can also be directly started via the Ethernet connection.



Note!

*If you have already installed a USB driver for a BCL 5xx*i* on your computer, you can also start the webConfig tool of the BCL 338*i* by double-clicking on the BCL 5xx*i* icon.*

Alternatively, you can start the webConfig tool by starting the browser installed on your PC and entering the following IP address: **192.168.61.100**

This is the default Leuze service address for communication with bar code readers of the BCL 300*i* and BCL 500*i* series.

In both cases, the following start page appears on your PC.

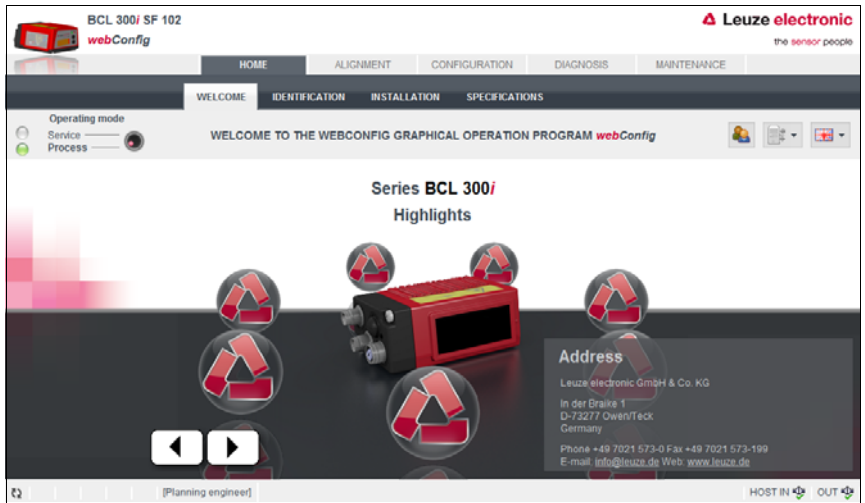


Figure 9.2: The start page of the webConfig tool



Note!

*The webConfig tool is completely contained in the firmware of the BCL 338*i*. Depending on firmware version, the start page may vary from that shown above.*

*If the webConfig communication (tunneled in EoE) between the engineering station and the BCL 338*i* is very slow, the cycle time of the PLC may have to be reduced (e.g. a cycle time of 0.4 ... 0.5 ms instead of 1 ms) and the web browser be restarted.*

The individual parameters are – where useful – graphically displayed in order to better illustrate the meaning of the what are often perceived as abstract parameters.

The result is an easy-to-use and practically-oriented user interface!

9.4 Short description of the webConfig tool

The webConfig tool has 5 main menus:

- **Home**
with information on the connected BCL 338*i* as well as on installation. This information corresponds to the information in this handbook.
- **Alignment**
for manually starting read processes and for aligning the bar code reader. The results of the read processes are displayed immediately. As a result, this menu item can be used to determine the optimum installation location.
- **Configuration**
for adjusting decoding, for data formatting and output, switching inputs/outputs, communication parameters and interfaces, etc. ...
- **Diagnostics**
for event logging of warnings and errors.
- **Maintenance**
for updating the firmware.

The user interface of the webConfig tool is largely self-explanatory.

9.4.1 Module overview in the Configuration menu

The adjustable parameters of the BCL 338*i* are clustered in modules in the Configuration menu.

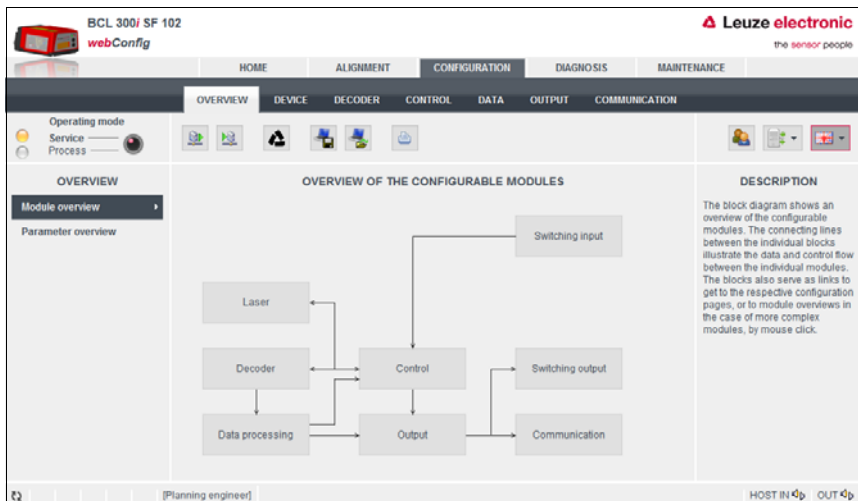


Figure 9.3: Module overview in the webConfig tool

**Note!**

The webConfig tool is completely contained in the firmware of the BCL 338i. Depending on firmware version, the module overview may vary from that shown above.

The individual modules and their relationships to one another are graphically displayed in the module overview. The display is context sensitive, i.e. click a module to directly access the corresponding submenu.

Overview of the configurable modules

- **Device:**
Configuration of the **switching inputs and outputs**
- **Decoder:**
Configuration of the decoder table, such as **code type, number of digits**, etc.
- **Control:**
Configuration of **activation** and **deactivation**, e.g. **auto-activation, AutoReflAct**, etc.
- **Data:**
Configuration of **code content**, such as **filtering, segmentation of bar code data**, etc.
- **Output:**
Configuration of **data output, header, trailer, reference code**, etc.
- **Communication:**
Configuration of the **host interface** and the **service interface**, e.g. **IP address**, etc.
- **Oscillating mirror:**
Configuration of the **oscillating mirror settings**

**Note!**

On the right side of the user interface of the webConfig tool, you will find a description of the individual modules and functions as a help text in the **Information** area.

10 Commissioning and configuration



Attention Laser!

Observe the safety notices in Chapter 2!

This chapter describes basic configuration steps which you can carry out via the webConfig tool.

Via the webConfig tool

The most convenient way to configure the BCL 338*i* is via the webConfig tool. To use the webConfig tool, you need to establish a USB connection between the BCL 338*i* and a PC/laptop.



Note!

Notes on the use of the webConfig tool can be found in Chapter 9 "Leuze webConfig tool" on page 99.

10.1 Measures to be performed prior to the initial commissioning

- ↳ Before commissioning, familiarize yourself with the operation and configuration of the BCL 338*i*.
- ↳ Before connecting the supply voltage, recheck all connections and ensure that they have been properly made.

The description of the electrical connections can be found in Chapter 7.

10.2 Starting the device

- ↳ Connect the +18 ... 30VDC supply voltage (typ. +24VDC); the BCL 338*i* starts up and the bar code reading window appears on the display.



Note!

The BCL 338*i* can decode the following code types in the standard setting:

- **Code 128** Number of digits 4 ... 63
- **2/5 Interleaved** Number of digits 10
- **Code 39** Number of digits 4 ... 30
- **EAN 8 / 13** Number of digits 8 and 13
- **UPC** Number of digits 8
- **Codabar** Number of digits 4 ... 63
- **Code 93** Number of digits 4 ... 63
- **Code GS1 Data Bar OMNIDIRECTIONAL**
- **Code GS1 Data Bar LIMITED**
- **Code GS1 Data Bar EXPANDED**

Deviations from these settings must be set via the webConfig tool. See "Leuze webConfig tool" on page 99.

As a first step, you need to set the communication parameters of the BCL 338*i*.

10.3 Additional settings for the BCL 338i

After the basic configuration of the operating mode and the communication parameters, you need to carry out further settings via the webConfig tool:

- Decoding and processing the read data
- Control of the decoding
- Control of the switching outputs

10.3.1 Decoding and processing the read data

The BCL 338i offers the following options:

- Setting the number of labels to be decoded for each reading gate (0 ... 64). This is done via the `Max. no. of labels` parameter.
- Definition of up to 8 different code types. Labels that match one of the defined code types are decoded. Further parameters can be set for each code type:
 - The code type (`symbology`)
 - The `Number of digits`: either up to 5 different numbers of digits (e.g., 10, 12, 16, 20, 24), or a range (`Interval mode`) and up to three additional numbers of digits (e.g., 2 ... 10, 12, 16, 26)
 - The `Reading reliability`: the set value specifies how many times a label must be read and decoded with the same result before the result is accepted as valid.
 - Additional code type specific settings (in the webConfig tool only)
 - `Check digit method` used for decoding as well as the type of `check digit transmission` for the output of the read result. The two possibilities for the latter are `Standard` (corresponds to the standard for the selected code type/symbology) and `not Standard`.

↳ *Define at least one code type with the desired settings.*

- Via webConfig:
Configuration -> Decoder

Data processing via the webConfig tool

In the **Data** and **Output** submenus of the **Configuration** main menu, the webConfig tool provides extensive data processing options to adapt the functionality of the BCL 338*i* to the specific reading task:

- Data filtering and segmentation in the **Data** submenu:
 - Data filtering according to characteristics for handling identical bar code information
 - Data segmentation for differentiating between identifier and content of the read data
 - Data filtering according to content and/or identifier in order to suppress the output of bar codes with specific content/identifiers
 - Completeness inspection of the read data
- Sorting and formatting the output data in the **Output** submenu:
 - Configuration of up to 3 different sorting criteria. Sorting by physical data and content of the read bar codes.
 - Formatting of the data output for the HOST.
 - Formatting of the data output for the display.

10.3.2 Control of the decoding

In general, decoding is controlled via one or more of the configurable switching inputs/outputs. For this purpose, the respective connection to the SW IN/OUT and POWER interfaces must be configured as a switching input.

Via a switching input, you can:

- Start decoding
 - Stop decoding
 - Start decoding and then stop decoding after a configurable time period
 - Read a reference code
 - Start the automatic code type configuration (AutoConfig)
- ↳ Connect the required control devices (photoelectric sensor, proximity switch, etc.) as described in Chapter 7 to the BCL 338i.
- ↳ Configure the connected switching inputs according to your requirements. To do this, first set the *I/O mode* to *Input* and then configure the switching behavior:
- Via webConfig:
Configuration > Device > Switching inputs/outputs



Note!

Alternatively, one can also activate decoding via the online command '+' and deactivate it via the online command '-'. Further information on the online commands can be found in Chapter 12.

Advanced decoder control via the webConfig tool

The webConfig tool provides advanced functions, in particular for deactivating decoding. These may be accessed via the Control submenu of the Configuration main menu. You can:

- Activate decoding automatically (delayed)
- Stop decoding after a maximum reading gate time
- Stop decoding via the completeness mode, if:
 - The maximum number of bar codes to be decoded has been decoded
 - a positive reference code comparison has taken place.

10.3.3 Control of the switching outputs

By using the switching inputs/outputs of the BCL 338*i*, external event-controlled functions can be implemented without assistance from the superior process control. For this purpose, the respective connection at the SW IN/OUT and POWER interfaces must be configured as a switching output.

A switching output can be activated:

- At the start/end of the reading gate
- Depending on the read result:
 - Reference code comparison positive/negative
 - Read result valid/invalid
- Depending on the state of the device:
 - Ready/not ready
 - Data transmission active/not active
 - Active/standby
 - Error/no error
- etc.

↳ As described in Chapter 7 of the manual, connect the required switching outputs.

↳ Configure the connected switching outputs according to your requirements. To do this, first set the *I/O mode* to *Output* and then configure the switching behavior:

- Via webConfig:
Configuration > Device > Switching inputs/outputs

10.4 Transmitting configuration data

Instead of going through the tedious task of configuring every parameter of the BCL 338*i* individually, you can also conveniently transfer configuration data.

Configuration data can be transferred between two bar code readers BCL 338*i* as follows

- Storage in a file and transfer using the webConfig tool

10.4.1 Via the webConfig tool

With the webConfig tool, you can store entire configurations of the BCL 338*i* on data carriers and transfer them from these to the BCL 338*i*.

This storage of configuration data is especially useful if you want to store basic configurations which will require only minor changes.

In the webConfig tool, you store the configuration data via the buttons in the upper part of the middle window of all submenus of the Configuration main menu.



Figure 10.1: Storing configuration data in the webConfig tool

10.4.2 Replacing a defective BCL 338*i*

The MS 338 connector hood, the ME 338... connection hood and the MK 338 terminal hood feature an integrated parameter memory in which the configuration data is saved as a backup. If a defective BCL 338*i* has to be replaced, proceed as follows:

- ↳ *Disconnect the defective BCL 338*i* from the voltage supply.*
- ↳ *Dismount the defective BCL 338*i* and disconnect it from the connection hood.*
- ↳ *Connect the new BCL 338*i* to the connection hood and remount the unit.*
- ↳ *Recommission the new BCL 338*i* (reconnect the voltage supply).*
*The configuration is now imported from the external parameter memory of the connection hood and the BCL 338*i* is immediately operational without any further configuration.*

11 BCL 338i in the EtherCAT system

11.1 Ethernet over EtherCAT - EoE

In an EtherCAT network, only EtherCAT communication is permitted. All Ethernet-based, non-EtherCAT communication (e.g., TCP/IP, UDP/IP, etc.) with the EtherCAT slave (e.g.: HTTP, FTP, Telnet, etc.) is tunneled via the EoE EtherCAT protocol. Used here is a mailbox channel which does not influence the cyclical, real-time process data exchange.

With the Ethernet-over-EtherCAT protocol, it is possible to transport all Ethernet data communication of the IT infrastructure in an EtherCAT network segment. For this purpose, Ethernet devices are connected to the EtherCAT network segment via switchports. The Ethernet frames are tunneled via EtherCAT. In the same way that, e.g., Internet protocols (TCP/IP, http, etc.) are tunneled in Ethernet frames, these are now embedded in EtherCAT frames. As a result, the EtherCAT network is fully transparent for these protocols.

The EoE telegrams are embedded by the EoE-capable slave device. The real-time properties of the network are not affected by this, as the sending and processing is handled via acyclic mailbox data communication, which has a much lower priority than the cyclical process-data exchange. Because the EoE master functions as a Layer 2 switch, it sends telegrams to the MAC addresses of the EoE nodes via EoE. For this purpose, a NetAdapter that has been adapted for EoE is realized in the BCL 338i that forwards the frames received from the EoE application to the corresponding component. This NetAdapter also passes on the frames in the network that are to be sent to the EoE application.

**Note!**

The IP address parameters needed for the EoE protocol are set for each slave in the engineering software (e.g., TwinCAT). Make certain that a valid IP address (i.e., not equal to x.x.x.0) is assigned in the EtherCAT master. Otherwise, the BCL 338i signals a warning: PWR LED flashes red.

With the exception of the IP address parameter needed for the EoE protocol, the BCL 338i is configured via the webConfig tool.

**Note!**

If the webConfig communication (tunneled in EoE) between the engineering station and the BCL 338i is very slow, the cycle time of the PLC may have to be reduced (e.g. a cycle time of 0.4 ... 0.5 ms instead of 1 ms) and the web browser be restarted.

**Note!**

The firmware can be updated via USB with the webConfig tool or via EoE. If USB either should not or cannot be used, the EtherCAT master must support the EoE service.

11.2 CANopen over EtherCAT - CoE

EtherCAT provides the communication mechanisms described below. In this context, the SDO accesses to the online dictionary via CoE (CANopen over EtherCAT) are carried out via mailbox services. PDO services via CoE mailboxes are not supported.

- Object index
- PDO, process data object
- SDO, service data object
- NMT, network management

Master and slave must be located in the same EtherCAT network.



Note!

Second Station Address (Configured Station Alias)

With the BCL 338i, the Second Station Address is set by the EtherCAT master. This address is typically assigned in the project engineering software (e.g., TwinCAT). No provision is made for setting via the webConfig tool. The Second Station Address can, however, be displayed in webConfig.

11.3 Starting the BCL 338i in the EtherCAT system

During starting up, the bar code reader runs through different states which are explained in brief in the following.

INIT

The BCL 338i initializes itself. No direct communication between the master and BCL 338i is possible. The EtherCAT master will transit the BCL 338i step by step into the "operational" state.

In the status change from "INIT" to "PREOP", the TwinCAT or master writes the so-called EtherCAT address (=station address) to the respective register of the EtherCAT slave controller (here: BCL 338i). This EtherCAT address is typically specified in relation to the position, i.e., the master's address is 1000, the first slave's address is 1001, etc. This is also called the auto-increment method.

PRE-OPERATIONAL

The master and the BCL 338i exchange application-specific initializations and device-specific parameters. In the PRE-OPERATIONAL state, configuration is initially possible via SDOs only.

SAFE-OPERATIONAL

The "Start Input Update" command puts the bar code reader into the "Safe-Operational" state. The master produces output data, but input data is not considered. This means the BCL 338i does not return output data (= PLC input data) in SAFEOP. The bar code reader processes input process data (= PLC output data). Mailbox communication via CoE services is possible.

OPERATIONAL

The "Start Output Update" command puts the bar code reader into the OPERATIONAL state. In this state, the BCL 338i supplies valid input data and the master valid output data. After the BCL 338i has detected the data received via the process data service, the state transition is confirmed by the BCL 338i. If the activation of the output data was not possible, the bar code reader remains in the SAFE OPERATIONAL state and outputs an error message.

11.4 Device profile

The object designations and groupings of the generic device profile of the BCL 338i are based on common bar code reader profiles. The basis here is the module concept familiar from the PNO world, transferred to the EtherCAT terminology. Users of other Leuze products can thereby get up to speed more quickly.

**Note!**

The objects do not support direct configuration of the device functionality. Configuration is not generally performed via the fieldbus protocol, but rather via the webConfig tool.

It is, however, possible to configure the BCL 338i using 'PT' sequences (see chapter 12.1.4 "Online commands for the parameter set operations" and see chapter 11.5.2 "Application case: Transmitting 'PT' sequences") from within the control. You can obtain detailed information on this topic from Leuze electronic on request.

The object directory is fixed. Object values can be changed depending on version. Only the mapping of the process data can be configured in the I/O objects.

11.4.1 Device description file

For EtherCAT, all process data and parameters are described in objects. The compilation of all process data and parameters of the gateway - the object directory - is stored in a so-called ESI file (EtherCAT Slave Information).

The ESI file contains all objects with index, sub-index, name, data type, default value, minimum and maximum, and access possibilities. That means the ESI file describes the entire functionality of the BCL 338i, and it is possible to adjust the communication of the bar code reader with the control.

List of supported objects

master

General EtherCAT Process Data Startup CoE - Online Online

Update List Auto Update Single Update Show Offline Data

Advanced...

Add to Startup... Module OD (AoE Port):

Index	Name	Flags	Value	Unit
1008	Device Name	RO	BCL338i	
1009	Hardware version	RO	3	
100A	Software Version	RO	V 1.8.0	
1018:0	Identity	RO	> 4 <	
1600:0	RxPDO1 Mapping	RO	> 12 <	
1601:0	RxPDO2 Mapping	RO	> 12 <	
1602:0	RxPDO3 Mapping	RO	> 13 <	
1603:0	RxPDO4 Mapping	RO	> 13 <	
1604:0	RxPDO5 Mapping	RO	> 14 <	
1605:0	RxPDO6 Mapping	RO	> 15 <	
1606:0	RxPDO7 Mapping	RO	> 16 <	
1607:0	RxPDO8 Mapping	RO	> 20 <	
1A00:0	TxPDO1 Mapping	RO	> 16 <	
1A01:0	TxPDO2 Mapping	RO	> 16 <	
1A02:0	TxPDO3 Mapping	RO	> 17 <	
1A03:0	TxPDO4 Mapping	RO	> 17 <	
1A04:0	TxPDO5 Mapping	RO	> 18 <	
1A05:0	TxPDO6 Mapping	RO	> 19 <	
1A06:0	TxPDO7 Mapping	RO	> 20 <	
1A07:0	TxPDO8 Mapping	RO	> 24 <	
1C00:0	Sync Manager type	RO	> 4 <	
1C12:0	RxPDO Assign	RW	> 1 <	
1C13:0	TxPDO Assign	RW	> 1 <	
2000:0	Result Data 1		> 8 <	
2001:0	Result Data 2		> 16 <	
2002:0	Result Data 3		> 32 <	
2003:0	Result Data 4		> 48 <	
2004:0	Result Data 5		> 64 <	
2005:0	Result Data 6		> 96 <	
2006:0	Result Data 7		> 128 <	
2007:0	Result Data 8		> 252 <	
2050:0	Result Data Settings	RO	> 7 <	
2100:0	Submission Data 1		> 8 <	
2101:0	Submission Data 2		> 16 <	
2102:0	Submission Data 3		> 32 <	
2103:0	Submission Data 4		> 48 <	
2104:0	Submission Data 5		> 64 <	
2105:0	Submission Data 6		> 96 <	
2106:0	Submission Data 7		> 128 <	
2107:0	Submission Data 8		> 252 <	
2150:0	Submission data settings	RW	> 5 <	
2200:0	Activation	RW	> 5 <	
2300:0	Fragmented result	RW	> 5 <	
2400:0	Fragmented submission	RW	> 5 <	
2450:0	Device Status and Device Control	RW	> 4 <	

Figure 11.1: Configuration options

The ESI file has the name **BCL338i.xml** and is available for download on the Leuze home page.

Vendor ID for the BCL 338i

The Vendor ID assigned by Leuze electronic for the BCL 338i is 121_h = 289_d.

11.4.2 Object directory overview

The object directory of the BCL 338i is the compilation of all process data and parameters of the bar code reader.

The following overview table shows all objects supported by the BCL 338i.

Object address (index) in hex	EtherCAT-specific object area
Communication objects	
1000	Device type
1008	Manufacturer Device Name
1009	Manufacturer Hardware Version
100A	Manufacturer Software Version
1018	Identity Object (contains general information regarding the device)
1600 ... 1607	1st ... 8th Receive PDO Mapping RxPDO1 ... RxPDO8 (mapping of the output data)
1A00 ... 1A07	1st ... 8th Transmit PDO Mapping TxPDO1 ... TxPDO8 (mapping of the input data)
1C00	Sync Manager Communication Type
1C12	Sync Manager 2 PDO Assignment
1C13	Sync Manager 3 PDO Assignment
Device-specific objects	
2000 ... 2007	Result data 1 ... 8 (input data length 8 / 16 / 32 / 48 / 64 / 96 / 128 / 252 bytes)
2050	Result data status
2100 ... 2107	Submission data 1 ... 8 (output data length 8 / 16 / 32 / 48 / 64 / 96 / 128 / 252 bytes)
2150	Submission data status
2200	Activation (device control)
2300	Fragmented result
2400	Fragmented submission (fragmented output data)
2450	Device status and control (device status, control bits for reset and standby)

Afterwards, you will find the respective detailed descriptions of the individual objects.



Note!

The data is described from the perspective of the control.

Output data (submission data) *Data that is transferred from the control (master) to the BCL 338i*

Input data (result data) *Data that is transferred from the BCL 338i to the control (master)*



Note!

Process data mappings that reflect process data objects (PDO) larger than 30 bytes in length make use of so-called padding bytes as described in ETG.1020. The EtherCAT master or the configuration tool of the master must support this mechanism.

11.4.3 Communication objects

11.4.3.1 Object 1000_h Device type

The object describes the device type.

Index (hex)	Sub-index (hex)	Name	Data type	Access	Value range			Comment
					Minimum	Maximum	Default	
1000	--	Device type	u32	ro	--	--	00000000 _h	Not a standardized device profile

11.4.3.2 Object 1008_h Manufacturer Device Name

This object contains the device names, i.e.: "BCL338i".

Index (hex)	Sub-index (hex)	Name	Data type	Access	Value range			Comment
					Minimum	Maximum	Default	
1008	--	Manufacturer Device Name	visible string	ro	--	--	"BCL338i"	

11.4.3.3 Object 1009_h Manufacturer Hardware Version

This object contains the hardware version of the main board.

Index (hex)	Sub-index (hex)	Name	Data type	Access	Value range			Comment
					Minimum	Maximum	Default	
1009	--	Manufacturer Hardware Version	visible string	ro	--	--	" ??? "	Example

11.4.3.4 Object 100A_h Manufacturer Software Version

This object contains the current software version of the firmware.

Index (hex)	Sub-index (hex)	Name	Data type	Access	Value range			Comment
					Minimum	Maximum	Default	
100A	--	Manufacturer Software Version	visible string	ro	--	--	" ??? "	Example



Note!

The firmware can be updated via USB with the webConfig tool or via EoE. If USB either should not or cannot be used, the EtherCAT master must support the EoE service.

11.4.3.5 Object 1018_h Identity Object

This object contains information for identification & maintenance functionality.

Index (hex)	Sub-index (hex)	Name	Data type	Access	Value range			Comment
					Minimum	Maximum	Default	
1018	00	Number of entries	u8	ro	0x00	0x04		
	01	Vendor ID	u32	ro	--	--	121 _h	Manufacturer ID number
	02	Product Code	u32	ro	--	--	05 _h	Product code
	03	Revision	u32	ro	--	--	02 _h	Example (is incremented with each new software version)
	04	Serial number	u32	ro	--	--	--	Example

The vendor ID of Leuze electronic GmbH + Co. KG is 289_d (121_h).

The product code of the BCL 338*i* is 5_d (5_h).

11.4.3.6 Objects 1600_h ... 1607_h – general mapping

This mapping is identical for all Receive PDO mapping objects and is, thus, present in every 1600_h ... 1607_h object. From the perspective of the control, this is the output data that is sent from the master to the BCL 338i.

(see Chapter 11.4.3.7 to Chapter 11.4.3.14).

Index (hex)	Sub-index (hex)	Name	Data type	Access	Value range			Comment
					Minimum	Maximum	Default	
1600 ... 1607	--	RxPDO1 ... RxPDO7	PDO Mapping	--	--	--	--	
	01	Sub-index01	u32	ro	--	--	0x08030022 _h	Object 2200, sub-index 03, "Activation signal"
	02	Sub-index02	u32	ro	--	--	0x08040022 _h	Object 2200, sub-index 04, "Data acknowledgment"
	03	Sub-index03	u32	ro	--	--	0x08050022 _h	Object 2200, sub-index 05, "Data reset"
	04	Sub-index04	u32	ro	--	--	0x08030024 _h	Object 2400, sub-index 03, "Fragment no."
	05	Sub-index05	u32	ro	--	--	0x08040024 _h	Object 2400, sub-index 04, "Remaining no. of fragments"
	06	Sub-index06	u32	ro	--	--	0x08050024 _h	Object 2400, sub-index 05, "Fragment size"
	07	Sub-index07	u32	ro	--	--	0x08045021 _h	Object 2150, sub-index 04, "New submission (toggle)"
	08	Sub-index08	u32	ro	--	--	0x08055021 _h	Object 2150, sub-index 05, "Submission data length"
	09	Sub-index09	u32	ro	--	--	0x08025024 _h	Object 2450, sub-index 02, "Error acknowledge (toggle)"
	0A	Sub-index10	u32	ro	--	--	0x08035024 _h	Object 2450, sub-index 03, "System reset"
	0B	Sub-index11	u32	ro	--	--	0x08045024 _h	Object 2450, sub-index 04, "Standby"

11.4.3.7 Object 1600_h 1st Receive PDO Mapping RxPDO1 (Submission data, 8 bytes)

This object defines the first Receive PDO mapping with the output data (data that is sent from the master to the BCL 338i).

The mapping object references device-specific object **0x2100_h Submission data 1** (see Chapter 11.4.4.3).

Index (hex)	Sub-index (hex)	Name	Data type	Access	Value range			Comment
					Minimum	Maximum	Default	
1600	--	RxPDO1	PDO Mapping	--	--	--	--	
	00	No. of mapping entries in this PDO	u8	ro	--	--	0x0C _h	12 _d Mapping entries
	01...0B	see chapter 11.4.3.6 "Objects 1600h ... 1607h – general mapping"						
	0C	1st Output object to be mapped	u32	ro	--	--	0x40000021 _h	Object 2100, 8 data bytes



Note!

Only one Receive PDO mapping object can be used at a time. Select the Receive PDO mapping object depending on the required data length.

11.4.3.8 Object 1601_h 2nd Receive PDO Mapping RxPDO2 (Submission data, 16 bytes)

This object defines the second Receive PDO mapping with the output data (data that is sent from the master to the BCL 338i).

The mapping object references device-specific object **0x2101_h Submission data 2** (see Chapter 11.4.4.3).

Index (hex)	Sub-index (hex)	Name	Data type	Access	Value range			Comment
					Minimum	Maximum	Default	
1601	--	RxPDO2	PDO Mapping	--	--	--	--	
	00	No. of mapping entries in this PDO	u8	ro	--	--	0x0C _h	12 _d Mapping entries
	01...0B	see chapter 11.4.3.6 "Objects 1600h ... 1607h – general mapping"						
	0C	1st Output object to be mapped	u32	ro	--	--	0x80000121 _h	Object 2101, 16 data bytes



Note!

Only one Receive PDO mapping object can be used at a time. Select the Receive PDO mapping object depending on the required data length.

11.4.3.9 Object 1602_h 3rd Receive PDO Mapping RxPDO3 (Submission data, 32 bytes)

This object defines the third Receive PDO mapping with the output data (data that is sent from the master to the BCL 338i).

The mapping object references device-specific object **0x2102_h Submission data 3** (see Chapter 11.4.4.3).

Index (hex)	Sub-index (hex)	Name	Data type	Access	Value range			Comment
					Minimum	Maximum	Default	
1602	--	RxPDO3	PDO Mapping	--	--	--	--	
	00	No. of mapping entries in this PDO	u8	ro	--	--	0x0D _h	13 _d Mapping entries
	01...0B	see chapter 11.4.3.6 "Objects 1600h ... 1607h – general mapping"						
	0C	1st Output object to be mapped	u32	ro	--	--	0xF0000221 _h	Object 2102, first 30 data bytes
	0D	2nd Output object to be mapped	u32	ro	--	--	0x10000000 _h	Object 2102, remaining 2 data bytes



Note!

Only one Receive PDO mapping object can be used at a time. Select the Receive PDO mapping object depending on the required data length.

The length of a mapping entry is limited to 255 bits (UINT8). PDO mapping entries > 31 bytes must be split over multiple entries with a maximum length of 30 bytes each. The first mapping entry contains index and sub-index. All other entries are realized as padding entries (index 0 and sub-index 0). Thus, the used EtherCAT master must be able to read and support these padding entries. For further information, see also the ETG.1020 Protocol Enhancements document from the ETG.

11.4.3.10 Object 1603_h 4th Receive PDO Mapping RxPDO4 (Submission data, 48 bytes)

This object defines the fourth Receive PDO mapping with the output data (data that is sent from the master to the BCL 338i).

The mapping object references device-specific object **0x2103_h Submission data 4** (see Chapter 11.4.4.3).

Index (hex)	Sub-index (hex)	Name	Data type	Access	Value range			Comment
					Minimum	Maximum	Default	
1603	--	RxPDO4	PDO Mapping	--	--	--	--	
	00	No. of mapping entries in this PDO	u8	ro	--	--	0x0D _h	13 _d Mapping entries
	01...0B	see chapter 11.4.3.6 "Objects 1600h ... 1607h – general mapping"						
	0C	1st Output object to be mapped	u32	ro	--	--	0xF0000321 _h	Object 2103, first 30 data bytes
	0D	2nd Output object to be mapped	u32	ro	--	--	0x90000000 _h	Object 2103, remaining 18 data bytes



Note!

Only one Receive PDO mapping object can be used at a time. Select the Receive PDO mapping object depending on the required data length.

The length of a mapping entry is limited to 255 bits (UINT8). PDO mapping entries > 31 bytes must be split over multiple entries with a maximum length of 30 bytes each. The first mapping entry contains index and sub-index. All other entries are realized as padding entries (index 0 and sub-index 0). Thus, the used EtherCAT master must be able to read and support these padding entries. For further information, see also the ETG.1020 Protocol Enhancements document from the ETG.

11.4.3.11 Object 1604_h 5th Receive PDO Mapping RxPDO5 (Submission data, 64 bytes)

This object defines the fifth Receive PDO mapping with the output data (data that is sent from the master to the BCL 338i).

The mapping object references device-specific object **0x2104_h Submission data 5** (see Chapter 11.4.4.3).

Index (hex)	Sub-index (hex)	Name	Data type	Access	Value range			Comment
					Minimum	Maximum	Default	
1604	--	RxPDO5	PDO Mapping	--	--	--	--	
	00	No. of mapping entries in this PDO	u8	ro	--	--	0x0E _h	14 _d Mapping entries
	01...0B	see chapter 11.4.3.6 "Objects 1600h ... 1607h – general mapping"						
	0C	1st Output object to be mapped	u32	ro	--	--	0xF0000421 _h	Object 2104, first 30 data bytes
	0D	2nd Output object to be mapped	u32	ro	--	--	0xF0000000 _h	Object 2104, next 30 data bytes
	0E	3rd Output object to be mapped	u32	ro	--	--	0x20000000 _h	Object 2104, remaining 4 data bytes



Note!

Only one Receive PDO mapping object can be used at a time. Select the Receive PDO mapping object depending on the required data length.

The length of a mapping entry is limited to 255 bits (UINT8). PDO mapping entries > 31 bytes must be split over multiple entries with a maximum length of 30 bytes each. The first mapping entry contains index and sub-index. All other entries are realized as padding entries (index 0 and sub-index 0). Thus, the used EtherCAT master must be able to read and support these padding entries. For further information, see also the ETG.1020 Protocol Enhancements document from the ETG.

11.4.3.12 Object 1605_h 6th Receive PDO Mapping RxPDO6 (Submission data, 96 bytes)

This object defines the sixth Receive PDO mapping with the output data (data that is sent from the master to the BCL 338i).

The mapping object references device-specific object **0x2105_h Submission data 6** (see Chapter 11.4.4.3).

Index (hex)	Sub-index (hex)	Name	Data type	Access	Value range			Comment
					Minimum	Maximum	Default	
1605	--	RxPDO6	PDO Mapping	--	--	--	--	
	00	No. of mapping entries in this PDO	u8	ro	--	--	0x0F _h	15 _d Mapping entries
	01...0B	see chapter 11.4.3.6 "Objects 1600h ... 1607h – general mapping"						
	0C	1st Output object to be mapped	u32	ro	--	--	0xF0000521 _h	Object 2105, first 30 data bytes
	0D	2nd Output object to be mapped	u32	ro	--	--	0xF0000000 _h	Object 2105, next 30 data bytes
	0E	3rd Output object to be mapped	u32	ro	--	--	0xF0000000 _h	Object 2105, next 30 data bytes
	0F	4th Output object to be mapped	u32	ro	--	--	0x30000000 _h	Object 2105, remaining 6 data bytes



Note!

Only one Receive PDO mapping object can be used at a time. Select the Receive PDO mapping object depending on the required data length.

The length of a mapping entry is limited to 255 bits (UINT8). PDO mapping entries > 31 bytes must be split over multiple entries with a maximum length of 30 bytes each. The first mapping entry contains index and sub-index. All other entries are realized as padding entries (index 0 and sub-index 0). Thus, the used EtherCAT master must be able to read and support these padding entries. For further information, see also the ETG.1020 Protocol Enhancements document from the ETG.

11.4.3.13 Object 1606_h 7th Receive PDO Mapping RxPDO7 (Submission data, 128 bytes)

This object defines the seventh Receive PDO mapping with the output data (data that is sent from the master to the BCL 338i).

The mapping object references device-specific object **0x2106_h Submission data 7** (see Chapter 11.4.4.3).

Index (hex)	Sub-index (hex)	Name	Data type	Access	Value range			Comment
					Minimum	Maximum	Default	
1606	--	RxPDO7	PDO Mapping	--	--	--	--	
	00	No. of mapping entries in this PDO	u8	ro	--	--	0x10 _h	16 _d Mapping entries
	01...0B	see chapter 11.4.3.6 "Objects 1600h ... 1607h – general mapping"						
	0C	1st Output object to be mapped	u32	ro	--	--	0xF0000621 _h	Object 2106, first 30 data bytes
	0D	2nd Output object to be mapped	u32	ro	--	--	0xF0000000 _h	Object 2106, next 30 data bytes
	0E	3rd Output object to be mapped	u32	ro	--	--	0xF0000000 _h	Object 2106, next 30 data bytes
	0F	4th Output object to be mapped	u32	ro	--	--	0xF0000000 _h	Object 2106, next 30 data bytes
	10	5th Output object to be mapped	u32	ro	--	--	0x40000000 _h	Object 2106, remaining 8 data bytes



Note!

Only one Receive PDO mapping object can be used at a time. Select the Receive PDO mapping object depending on the required data length.

The length of a mapping entry is limited to 255 bits (UINT8). PDO mapping entries > 31 bytes must be split over multiple entries with a maximum length of 30 bytes each. The first mapping entry contains index and sub-index. All other entries are realized as padding entries (index 0 and sub-index 0). Thus, the used EtherCAT master must be able to read and support these padding entries. For further information, see also the ETG.1020 Protocol Enhancements document from the ETG.

11.4.3.14 Object 1607_h 8th Receive PDO Mapping RxPDO8 (Submission data, 252 bytes)

This object defines the eighth Receive PDO mapping with the output data (data that is sent from the master to the BCL 338i).

The mapping object references device-specific object **0x2107_h Submission data 8** (see Chapter 11.4.4.3).

Index (hex)	Sub-index (hex)	Name	Data type	Access	Value range			Comment
					Minimum	Maximum	Default	
1607	--	RxPDO8	PDO Mapping	--	--	--	--	
	00	No. of mapping entries in this PDO	u8	ro	--	--	0x14 _h	20 _d Mapping entries
	01...0B	see chapter 11.4.3.6 "Objects 1600h ... 1607h – general mapping"						
	0C	1st Output object to be mapped	u32	ro	--	--	0xF0000721 _h	Object 2107, first 30 data bytes
	0D	2nd Output object to be mapped	u32	ro	--	--	0xF0000000 _h	Object 2107, next 30 data bytes
	0E	3rd Output object to be mapped	u32	ro	--	--	0xF0000000 _h	Object 2107, next 30 data bytes
	0F	4th Output object to be mapped	u32	ro	--	--	0xF0000000 _h	Object 2107, next 30 data bytes
	10	5th Output object to be mapped	u32	ro	--	--	0xF0000000 _h	Object 2107, next 30 data bytes
	11	6th Output object to be mapped	u32	ro	--	--	0xF0000000 _h	Object 2107, next 30 data bytes
	12	7th Output object to be mapped	u32	ro	--	--	0xF0000000 _h	Object 2107, next 30 data bytes
	13	8th Output object to be mapped	u32	ro	--	--	0xF0000000 _h	Object 2107, next 30 data bytes
	14	9th Output object to be mapped	u32	ro	--	--	0x80000000 _h	Object 2107, remaining 12 data bytes



Note!

Only one Receive PDO mapping object can be used at a time. Select the Receive PDO mapping object depending on the required data length.

The length of a mapping entry is limited to 255 bits (UINT8). PDO mapping entries > 31 bytes must be split over multiple entries with a maximum length of 30 bytes each. The first mapping entry contains index and sub-index. All other entries are realized as padding entries (index 0 and sub-index 0). Thus, the used EtherCAT master must be able to read and support these padding entries. For further information, see also the ETG.1020 Protocol Enhancements document from the ETG.

11.4.3.15 Objects 1A00_h ... 1A07_h – general mapping

This mapping is identical for all Transmit PDO mapping objects and is, thus, present in every 1A00_h ... 1A07_h object. From the perspective of the control, this is the input data that is sent from the BCL 338i to the master.

(see Chapter 11.4.3.16 to Chapter 11.4.3.23).

Index (hex)	Sub-index (hex)	Name	Data type	Access	Value range			Comment
					Minimum	Maximum	Default	
1A00 ... 1A07	--	TxPDO1 ... TxPDO7	PDO Mapping	--	--	--	--	
	01	Sub-index01	u32	ro	--	--	0x0802002 _h	Object 2200, sub-index 02, "Number of results"
	02	Sub-index02	u32	ro	--	--	0x0803002 _h	Object 2300, sub-index 03, "Fragment no."
	03	Sub-index03	u32	ro	--	--	0x0804002 _h	Object 2300, sub-index 04, "Remaining no. of fragments"
	04	Sub-index04	u32	ro	--	--	0x0805002 _h	Object 2300, sub-index 05, "Fragment size"
	05	Sub-index05	u32	ro	--	--	0x0801502 _h	Object 2050, sub-index 01, "Activation status"
	06	Sub-index06	u32	ro	--	--	0x0802502 _h	Object 2050, sub-index 02, "Code data or command response"
	07	Sub-index07	u32	ro	--	--	0x0803502 _h	Object 2050, sub-index 03, "More results in buffer"
	08	Sub-index08	u32	ro	--	--	0x0804502 _h	Object 2050, sub-index 04, "Buffer overflow"
	09	Sub-index09	u32	ro	--	--	0x0805502 _h	Object 2050, sub-index 05, "New result (toggle)"
	0A	Sub-index10	u32	ro	--	--	0x0806502 _h	Object 2050, sub-index 06, "Waiting on master response"
	0B	Sub-index11	u32	ro	--	--	0x1007502 _h	Object 2050, sub-index 07, "Result data length"
	0C	Sub-index12	u32	ro	--	--	0x0801502 _h	Object 2150, sub-index 01, "Data transfer (toggle)"
	0D	Sub-index13	u32	ro	--	--	0x0802502 _h	Object 2150, sub-index 02, "Data rejection (toggle)"

Index (hex)	Sub-index (hex)	Name	Data type	Access	Value range			Comment
					Minimum	Maximum	Default	
	0E	Sub-index14	u32	ro	--	--	0x08035021 _h	Object 2150, sub-index 03, "Error code"
	0F	Sub-index15	u32	ro	--	--	0x08015024 _h	Object 2450, sub-index 01, "Device status"

11.4.3.16 Object 1A00_h 1st Transmit PDO Mapping TxPDO1 (Result data, 8 bytes)

This object defines the first Transmit PDO mapping with the result data (input data that is sent from the BCL 338i to the master).

The mapping object references device-specific object **0x2000_h Result data 1** (see Chapter 11.4.4.1).

Index (hex)	Sub-index (hex)	Name	Data type	Access	Value range			Comment
					Minimum	Maximum	Default	
1A00	--	TxPDO1	PDO Mapping	--	--	--	--	
	00	No. of mapping entries in this PDO	u8	ro	--	--	0x10 _h	16 _d Mapping entries
	01...0F	see chapter 11.4.3.15 "Objects 1A00h ... 1A07h – general mapping"						
	10	1st Input object to be mapped	u32	ro	--	--	0x40000020 _h	Object 2000, 8 data bytes



Note!

Only one Transmit PDO mapping object can be used at a time. Select the Transmit PDO mapping object depending on the required data length.

11.4.3.17 Object 1A01_h 2nd Transmit PDO Mapping TxPDO2 (Result data, 16 bytes)

This object defines the second Transmit PDO mapping with the result data (input data that is sent from the BCL 338i to the master).

The mapping object references device-specific object **0x2001_h Result data 2** (see Chapter 11.4.4.1).

Index (hex)	Sub-index (hex)	Name	Data type	Access	Value range			Comment
					Minimum	Maximum	Default	
1A01	--	TxPDO2	PDO Mapping	--	--	--	--	
	00	No. of mapping entries in this PDO	u8	ro	--	--	0x10 _h	16 _d Mapping entries
	01...0F	see chapter 11.4.3.15 "Objects 1A00h ... 1A07h – general mapping"						
	10	1st Input object to be mapped	u32	ro	--	--	0x80000120 _h	Object 2001, 16 data bytes



Note!

Only one Transmit PDO mapping object can be used at a time. Select the Transmit PDO mapping object depending on the required data length.

11.4.3.18 Object 1A02_h, 3rd Transmit PDO Mapping TxPDO3 (Result data, 32 bytes)

This object defines the third Transmit PDO mapping with the result data (input data that is sent from the BCL 338*i* to the master).

The mapping object references device-specific object **0x2002_h Result data 3** (see Chapter 11.4.4.1).

Index (hex)	Sub-index (hex)	Name	Data type	Access	Value range			Comment
					Minimum	Maximum	Default	
1A02	--	TxPDO3	PDO Mapping	--	--	--	--	
	00	No. of mapping entries in this PDO	u8	ro	--	--	0x11 _h	17 _d Mapping entries
	01...0F	see chapter 11.4.3.15 "Objects 1A00h ... 1A07h – general mapping"						
	10	1st Input object to be mapped	u32	ro	--	--	0xF0000220 _h	Object 2002, first 30 data bytes
	11	2nd Input object to be mapped	u32	ro	--	--	0x10000000 _h	Object 2002, remaining 2 data bytes



Note!

Only one Transmit PDO mapping object can be used at a time. Select the Transmit PDO mapping object depending on the required data length.

The length of a mapping entry is limited to 255 bits (UINT8). PDO mapping entries > 31 bytes must be split over multiple entries with a maximum length of 30 bytes each. The first mapping entry contains index and sub-index. All other entries are realized as padding entries (index 0 and sub-index 0). Thus, the used EtherCAT master must be able to read and support these padding entries. For further information, see also the ETG.1020 Protocol Enhancements document from the ETG.

11.4.3.19 Object 1A03_h 4th Transmit PDO Mapping TxPDO4 (Result data, 48 bytes)

This object defines the fourth Transmit PDO mapping with the result data (input data that is sent from the BCL 338i to the master).

The mapping object references device-specific object 0x2003_h **Result data 4** (see Chapter 11.4.4.1).

Index (hex)	Sub-index (hex)	Name	Data type	Access	Value range			Comment
					Minimum	Maximum	Default	
1A03	--	TxPDO4	PDO Mapping	--	--	--	--	
	00	No. of mapping entries in this PDO	u8	ro	--	--	0x11 _h	17 _d Mapping entries
	01...0F	see chapter 11.4.3.15 "Objects 1A00h ... 1A07h – general mapping"						
	10	1st Input object to be mapped	u32	ro	--	--	0xF0000320 _h	Object 2003, first 30 data bytes
	11	2nd Input object to be mapped	u32	ro	--	--	0x90000000 _h	Object 2003, remaining 18 data bytes



Note!

Only one Transmit PDO mapping object can be used at a time. Select the Transmit PDO mapping object depending on the required data length.

The length of a mapping entry is limited to 255 bits (UINT8). PDO mapping entries > 31 bytes must be split over multiple entries with a maximum length of 30 bytes each. The first mapping entry contains index and sub-index. All other entries are realized as padding entries (index 0 and sub-index 0). Thus, the used EtherCAT master must be able to read and support these padding entries. For further information, see also the ETG.1020 Protocol Enhancements document from the ETG.

11.4.3.20 Object 1A04_h, 5th Transmit PDO Mapping TxPDO5 (Result data, 64 bytes)

This object defines the fifth Transmit PDO mapping with the result data (input data that is sent from the BCL 338*i* to the master).

The mapping object references device-specific object **0x2004_h Result data 5** (see Chapter 11.4.4.1).

Index (hex)	Sub-index (hex)	Name	Data type	Access	Value range			Comment
					Minimum	Maximum	Default	
1A04	--	TxPDO5	PDO Mapping	--	--	--	--	
	00	No. of mapping entries in this PDO	u8	ro	--	--	0x12 _h	18 _d Mapping entries
	01...0F	see chapter 11.4.3.15 "Objects 1A00h ... 1A07h – general mapping"						
	10	1st Input object to be mapped	u32	ro	--	--	0xF0000420 _h	Object 2004, first 30 data bytes
	11	2nd Input object to be mapped	u32	ro	--	--	0xF0000000 _h	Object 2004, next 30 data bytes
	12	3rd Input object to be mapped	u32	ro	--	--	0x20000000 _h	Object 2004, remaining 4 data bytes



Note!

Only one Transmit PDO mapping object can be used at a time. Select the Transmit PDO mapping object depending on the required data length.

The length of a mapping entry is limited to 255 bits (UINT8). PDO mapping entries > 31 bytes must be split over multiple entries with a maximum length of 30 bytes each. The first mapping entry contains index and sub-index. All other entries are realized as padding entries (index 0 and sub-index 0). Thus, the used EtherCAT master must be able to read and support these padding entries. For further information, see also the ETG.1020 Protocol Enhancements document from the ETG.

11.4.3.21 Object 1A05_h 6th Transmit PDO Mapping TxPDO6 (Result data, 96 bytes)

This object defines the sixth Transmit PDO mapping with the result data (input data that is sent from the BCL 338i to the master).

The mapping object references device-specific object 0x2005_h **Result data 6** (see Chapter 11.4.4.1).

Index (hex)	Sub-index (hex)	Name	Data type	Access	Value range			Comment
					Minimum	Maximum	Default	
1A05	--	TxPDO6	PDO Mapping	--	--	--	--	
	00	No. of mapping entries in this PDO	u8	ro	--	--	0x13 _h	19 _d Mapping entries
	01...0F	see chapter 11.4.3.15 "Objects 1A00h ... 1A07h – general mapping"						
	10	1st Input object to be mapped	u32	ro	--	--	0xF0000520 _h	Object 2005, first 30 data bytes
	11	2nd Input object to be mapped	u32	ro	--	--	0xF0000000 _h	Object 2005, next 30 data bytes
	12	3rd Input object to be mapped	u32	ro	--	--	0xF0000000 _h	Object 2005, next 30 data bytes
	13	4th Input object to be mapped	u32	ro	--	--	0x30000000 _h	Object 2005, remaining 6 data bytes



Note!

Only one Transmit PDO mapping object can be used at a time. Select the Transmit PDO mapping object depending on the required data length.

The length of a mapping entry is limited to 255 bits (UINT8). PDO mapping entries > 31 bytes must be split over multiple entries with a maximum length of 30 bytes each. The first mapping entry contains index and sub-index. All other entries are realized as padding entries (index 0 and sub-index 0). Thus, the used EtherCAT master must be able to read and support these padding entries. For further information, see also the ETG.1020 Protocol Enhancements document from the ETG.

11.4.3.22 Object 1A06_h, 7th Transmit PDO Mapping TxPDO7 (Result data, 128 bytes)

This object defines the seventh Transmit PDO mapping with the result data (input data that is sent from the BCL 338*i* to the master).

The mapping object references device-specific object **0x2006_h Result data 7** (see Chapter 11.4.4.1).

Index (hex)	Sub-index (hex)	Name	Data type	Access	Value range			Comment
					Minimum	Maximum	Default	
1A06	--	TxPDO7	PDO Mapping	--	--	--	--	
	00	No. of mapping entries in this PDO	u8	ro	--	--	0x14 _h	20 _d Mapping entries
	01...0F	see chapter 11.4.3.15 "Objects 1A00h ... 1A07h – general mapping"						
	10	1st Input object to be mapped	u32	ro	--	--	0xF0000620 _h	Object 2006, first 30 data bytes
	11	2nd Input object to be mapped	u32	ro	--	--	0xF0000000 _h	Object 2006, next 30 data bytes
	12	3rd Input object to be mapped	u32	ro	--	--	0xF0000000 _h	Object 2006, next 30 data bytes
	13	4th Input object to be mapped	u32	ro	--	--	0xF0000000 _h	Object 2006, next 30 data bytes
	14	5th Input object to be mapped	u32	ro	--	--	0x40000000 _h	Object 2006, remaining 8 data bytes



Note!

Only one Transmit PDO mapping object can be used at a time. Select the Transmit PDO mapping object depending on the required data length.

The length of a mapping entry is limited to 255 bits (UINT8). PDO mapping entries > 31 bytes must be split over multiple entries with a maximum length of 30 bytes each. The first mapping entry contains index and sub-index. All other entries are realized as padding entries (index 0 and sub-index 0). Thus, the used EtherCAT master must be able to read and support these padding entries. For further information, see also the ETG.1020 Protocol Enhancements document from the ETG.

11.4.3.23 Object 1A07_h 8th Transmit PDO Mapping TxPDO8 (Result data, 252 bytes)

This object defines the eighth Transmit PDO mapping with the result data (input data that is sent from the BCL 338i to the master).

The mapping object references device-specific object **0x2007_h Result data 8** (see Chapter 11.4.4.1).

Index (hex)	Sub-index (hex)	Name	Data type	Access	Value range			Comment
					Minimum	Maximum	Default	
1A07	--	TxPDO8	PDO Mapping	--	--	--	--	
	00	No. of mapping entries in this PDO	u8	ro	--	--	0x18 _h	24 _d Mapping entries
01...0F		see chapter 11.4.3.15 "Objects 1A00h ... 1A07h – general mapping"						
	10	1st Input object to be mapped	u32	ro	--	--	0xF0000720 _h	Object 2007, first 30 data bytes
	11	2nd Input object to be mapped	u32	ro	--	--	0xF0000000 _h	Object 2007, next 30 data bytes
	12	3rd Input object to be mapped	u32	ro	--	--	0xF0000000 _h	Object 2007, next 30 data bytes
	13	4th Input object to be mapped	u32	ro	--	--	0xF0000000 _h	Object 2007, next 30 data bytes
	14	5th Input object to be mapped	u32	ro	--	--	0xF0000000 _h	Object 2007, next 30 data bytes
	15	6th Input object to be mapped	u32	ro	--	--	0xF0000000 _h	Object 2007, next 30 data bytes
	16	7th Input object to be mapped	u32	ro	--	--	0xF0000000 _h	Object 2007, next 30 data bytes
	17	8th Input object to be mapped	u32	ro	--	--	0xF0000000 _h	Object 2007, next 30 data bytes
	18	9th Input object to be mapped	u32	ro	--	--	0x80000000 _h	Object 2007, remaining 12 data bytes



Note!

Only one Transmit PDO mapping object can be used at a time. Select the Transmit PDO mapping object depending on the required data length.

The length of a mapping entry is limited to 255 bits (UINT8). PDO mapping entries > 31 bytes must be split over multiple entries with a maximum length of 30 bytes each. The first mapping entry contains index and sub-index. All other entries are realized as padding entries (index 0 and sub-index 0). Thus, the used EtherCAT master must be able to read and support these padding entries. For further information, see also the ETG.1020 Protocol Enhancements document from the ETG.

11.4.3.24 Object 1C00_n Sync Manager Communication Type

This object defines which Sync Manager realizes which data channel.
The BCL 338*i* is configured as follows.

Index (hex)	Sub-index (hex)	Name	Data type	Access	Value range			Comment
					Minimum	Maximum	Default	
1C00	--	Sync Manager Communication Type	record	--	--	--	0x04	4 entries
	01	Communication Type Sync Manager 0	u8	ro	--	--	0x01	Mailbox Receive (master to slave)
	02	Communication Type Sync Manager 1	u8	ro	--	--	0x02	Mailbox Send (slave to master)
	03	Communication Type Sync Manager 2	u8	ro	--	--	0x03	Process Data Output (master to slave)
	04	Communication Type Sync Manager 3	u8	ro	--	--	0x04	Process Data Input (slave to master)

11.4.3.25 Object 1C12_h Sync Manager 2 PDO Assignment

This object defines the Receive PDO object RxPDO1 ... RxPDO8 assigned to Sync Manager 2.

Index (hex)	Sub-index (hex)	Name	Data type	Access	Value range			Comment
					Minimum	Maximum	Default	
1C12	--	Sync Manager 2 PDO Assignment	record	--	--	--	--	
	00	Number of assigned PDOs	u8	rw	0x00	0x01	0x01	1
	01	PDO mapping object index of assigned PDO	u16	rw	0x1600	0x1607	0x1602	RxPDO1 ... RxPDO8 Default: RxPDO3



Note!

Only one Receive PDO mapping object can be used at a time. Select the Receive PDO mapping object depending on the required data length.

11.4.3.26 Object 1C13_h Sync Manager 3 PDO Assignment

This object defines the Transmit PDO object TxPDO1 ... TxPDO8 assigned to Sync Manager 3.

Index (hex)	Sub-index (hex)	Name	Data type	Access	Value range			Comment
					Minimum	Maximum	Default	
1C12	--	Sync Manager 2 PDO Assignment	record	--	--	--	--	
	00	Number of assigned PDOs	u8	rw	0x00	0x01	0x01	1
	01	PDO mapping object index of assigned PDO	u16	rw	0x1A00	0x1A07	0x1A02	TxPDO1 ... TxPDO8 Default: TxPDO3



Note!

Only one Transmit PDO mapping object can be used at a time. Select the Transmit PDO mapping object depending on the required data length.

11.4.4 Device-specific objects

11.4.4.1 Objects 0x2000_h to 0x2007_h Result data



Note!

Listed in the following are a number of objects used for outputting the result data. They have the same structure but different data lengths.

The object directory concept used with EtherCAT makes no provision for objects with variable data length.

Thus, objects 0x2000_h to 0x2007_h are to be considered as alternatives and cannot be simultaneously assigned to the process image via the process data mapping, see communication objects 1600_h to 1607_h.

These objects contain the result data (read results of the BCL 338i). The result data is dependent on the selected result formatting. This can be selected and configured with the webConfig tool.

Index (hex)	Sub-index (hex)	Name	Data type	Size (bit)	Access	Value range			Comment
						Minimum	Maximum	Default	
2000	00	Result data 1	array of byte	64	ro	0 _d	255 _d	0 _d	Result data 1 (max. 8 bytes)
2001	00	Result data 2	array of byte	128	ro	0 _d	255 _d	0 _d	Result data 2 (max. 16 bytes)
2002	00	Result data 3	array of byte	256	ro	0 _d	255 _d	0 _d	Result data 3 (max. 32 bytes)
2003	00	Result data 4	array of byte	384	ro	0 _d	255 _d	0 _d	Result data 4 (max. 48 bytes)
2004	00	Result data 5	array of byte	512	ro	0 _d	255 _d	0 _d	Result data 5 (max. 64 bytes)
2005	00	Result data 6	array of byte	768	ro	0 _d	255 _d	0 _d	Result data 6 (max. 96 bytes)
2006	00	Result data 7	array of byte	1024	ro	0 _d	255 _d	0 _d	Result data 7 (max. 128 bytes)
2007	00	Result data 8	array of byte	2048	ro	0 _d	255 _d	0 _d	Result data 8 (max. 256 bytes)

Each object contains the formatted result information in the length of the respective result data object.

Examples: Object Result data 1 contains 8 bytes,
Object Result data 8 contains 256 bytes.

11.4.4.2 Object 0x2050_h Status result data

This object contains the status of result data objects 0x2000_h to 0x2007_h, i.e., the status information refers to all result data objects and is, thus, the same for all result data objects.

Index (hex)	Sub-index (hex)	Name	Data type	Access	Value range			Comment
					Minimum	Maximum	Default	
2050	--	Result data status	record		--	--	--	Result data status
	00	No. of sub-indexes	byte	ro	0 _d	7 _d	7 _d	Number of sub-indexes
	01	Activation status	byte	ro	0 _d	1 _d	0 _d	Activation status
	02	Code data or command response	byte	ro	0 _d	1 _d	0 _d	Code content or command acknowledgment
	03	More results in buffer	byte	ro	0 _d	1 _d	0 _d	Further results in the buffer
	04	Buffer overflow	byte	ro	0 _d	1 _d	0 _d	Buffer overflow
	05	New result (toggle)	byte	ro	0 _d	1 _d	0 _d	New result
	06	Waiting on master response	byte	ro	0 _d	1 _d	0 _d	Waiting for acknowledgment
	07	Result data length	u16	ro	0 _d	65535 _d	0 _d	Result data length

No. of sub-indexes

Specifies the number of sub-indexes.

Activation status

This status bit displays the current activation status

- 0 Deactivated (reading gate closed)
- 1 Activated (reading gate opened)

Code data or command response

The status bit makes it easier to distinguish whether the result data is a formatted read result (formatted code content) or the response from the command interpreter of the BCL 338*i*.

- 0 Formatted read result (formatted code content)
- 1 Response from the command interpreter of the BCL 338*i*

More results in buffer

The status bit indicates whether there is still more result data in the buffer.

- 0 No further result data in the buffer
- 1 More result data in the buffer

Buffer overflow

This status bit indicates that all result buffers are full and the bar code reader rejects new read results.

- 0 No buffer overflow
- 1 Buffer overflow

New result (toggle)

This toggle bit indicates whether new result data is present.

- 0 -> 1 New result data
- 1 -> 0 New result data

Waiting on master response

This status bit represents the state of the internal control of the BCL 338i.

- 0 Operative state
- 1 Control waiting for acknowledgment from the master

Result data length

This sub-object contains the data length of the actual result information.

Value range: 0_d ... 65535_d bytes

If the actual result data length is less than or equal to the length of the result data object mapped in the process image, this value corresponds to the length of the actually transmitted data.

If the actual result data length is greater than the selected result data object, this means an information loss during transmission.

11.4.4.3 Objects 0x2100_h to 0x2107_h Submission data



Note!

Listed in the following are multiple objects for outputting data (from the perspective of the control).

This object enables the transmission of arbitrary data/commands to the command interpreter of the BCL 338i. The device can thereby be completely controlled.

The commands are transferred to the BCL 338i with the help of output data objects 0x2100_h to 0x2107_h.

The responses to the commands are transmitted back to the control with the help of result data objects 0x2000_h to 0x2007_h.

Objects 0x2100_h to 0x2107_h are to be considered as alternatives and cannot be simultaneously assigned to the process image via the process data mapping, see communication objects 1A00_h to 1A07_h.

These objects contain the input data (output data from the perspective of the control).

Index (hex)	Sub-index (hex)	Name	Data type	Size (bit)	Access	Value range			Comment
						Minimum	Maximum	Default	
2100	00	Submission data 1	array of byte	64	ro	0 _d	255 _d	0 _d	Output data 1 (max. 8 bytes)
2101	00	Submission data 2	array of byte	128	ro	0 _d	255 _d	0 _d	Output data 2 (max. 16 bytes)
2102	00	Submission data 3	array of byte	256	ro	0 _d	255 _d	0 _d	Output data 3 (max. 32 bytes)
2103	00	Submission data 4	array of byte	384	ro	0 _d	255 _d	0 _d	Output data 4 (max. 48 bytes)
2104	00	Submission data 5	array of byte	512	ro	0 _d	255 _d	0 _d	Output data 5 (max. 64 bytes)
2105	00	Submission data 6	array of byte	768	ro	0 _d	255 _d	0 _d	Output data 6 (max. 96 bytes)
2106	00	Submission data 7	array of byte	1024	ro	0 _d	255 _d	0 _d	Output data 7 (max. 128 bytes)
2107	00	Submission data 8	array of byte	2048	ro	0 _d	255 _d	0 _d	Output data 8 (max. 256 bytes)

Each object contains the output information in the length of the respective output data object.

Examples: Object Submission data 1 contains 8 bytes,
object Submission data 8 contains 256 bytes.



Note!

The objects do not support direct configuration of the device functionality. Configuration is not generally performed via the fieldbus protocol, but rather via the webConfig tool.

It is, however, possible to configure the BCL 338i using 'PT' sequences (see chapter 12.1.4 "Online commands for the parameter set operations") from within the control. You can obtain detailed information on this topic from Leuze electronic on request.

Principle data sequence during data acceptance/data rejection

In the following sequence diagram, first a successful data transmission is shown, then a failed data transfer.

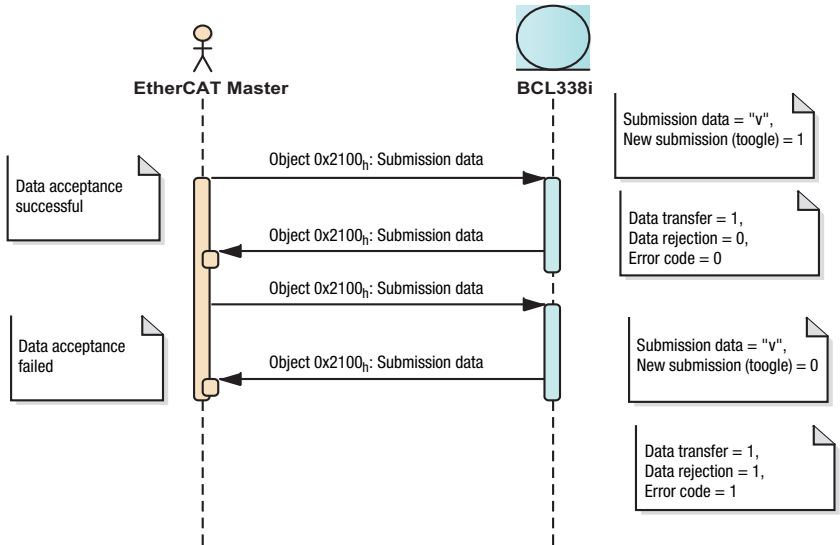


Figure 11.2: Sequence diagram for data acceptance/data rejection

Successful data acceptance from the perspective of the BCL 338i (object index 2150_h):

Initial situation:

- Toggle bit **Data transfer** = 0 or 1,
- Toggle bit **Data rejection** = 0 or 1,
- Toggle bit **New submission** = 0 -> 1 or 1 -> 0 (just changed)

Reaction of the BCL 338i on successful data acceptance:

Toggle bit **Data transfer** = 0 -> 1 or 1 -> 0,

Failed data acceptance from the perspective of the BCL 338i (object index 2150_h):

Initial situation:

- Toggle bit **Data transfer** = 0 or 1,
- Toggle bit **Data rejection** = 0 or 1,
- Toggle bit **New submission** = 0 -> 1 or 1 -> 0 (just changed)

Reaction of the BCL 338i on failed data acceptance:

Toggle bit **Data rejection** = 0 -> 1 or 1 -> 0

**Note!**

With the toggle bits, edges, i.e., transitions from 0 to 1 or vice versa, are decisive. The absolute value is irrelevant.

11.4.4.4 Object 0x2150_h Status submission data

This object contains the status of output data objects 0x2100_h to 0x2107_h, i.e., the status information refers to all output data objects (from the perspective of the control) and is, thus, the same for all output data objects.

Index (hex)	Sub-index (hex)	Name	Data type	Access	Value range			Comment
					Minimum	Maximum	Default	
2150	--	Submission data status	record		--	--	--	Output data status
	00	No. of sub-indexes	byte	ro	0 _d	5 _d	5 _d	Number of sub-indexes
	01	Data transfer (toggle)	byte	ro	0 _d	1 _d	0 _d	Data acceptance
	02	Data rejection (toggle)	byte	ro	0 _d	1 _d	0 _d	Data rejection
	03	Error code	byte	ro	0 _d	8 _d	0 _d	Error code
	04	New submission (toggle)	byte	nw	0 _d	1 _d	0 _d	New output data
	05	Submission data length	u16	nw	0 _d	65535 _d	0 _d	Output data length

No. of sub-indexes

Specifies the number of sub-indexes.

Data transfer (toggle)

The toggle bit shows that the BCL 338*i* has accepted the data or the data fragment (also see **Data rejection (toggle)**).

- 0 -> 1 Data has been accepted
- 1 -> 0 Data has been accepted

Data rejection (toggle)

This toggle bit indicates that the BCL 338*i* has rejected acceptance of the data or of the data fragment (see also **Data transfer (toggle)**).

- 0 -> 1 Data has been rejected
- 1 -> 0 Data has been rejected

Error code

This byte contains the cause of error upon rejection of input data.

- 0_d No error
- 1_d Receive Buffer Overflow
- 2_d Sequence error, i.e. an error was detected with the fragment number trans-

ferred from the control, the number of remaining fragments or the fragment size.

New submission (toggle)

This toggle bit indicates whether new output data is present.

0 -> 1	New output data
1 -> 0	New output data

Submission data length

This sub-object contains the data length of the actual output information.

Value range: $0_d \dots 65535_d$ bytes

If the actual output data length is less than or equal to the length of the output data object mapped in the process image, this value corresponds to the length of the actually transmitted data.

If the actual output data length is greater than the selected output data object, this means an information loss during transmission.



Note!

The data reset (see object $0x2200_h$ sub-index 05_h) does **not** influence the output data toggle bits.

If fragmented transmission is used, it must always be ensured on the application side for each fragment that is to be transmitted that the output data of fragmented submission object $0x2400_h$ is set **before** toggle bit **New submission (toggle)** is toggled in the object described here.

11.4.4.5 Object 0x2200_h Activation

The object 0x2200_h defines the control signals for activating the device as well as the signals for the control of the result output. It is possible to select between standard data output operation and handshake operation.

In handshake operation, the control must acknowledge the data reception via the ACK bit before the new data is written into the input area.

After acknowledging the last result, the input data is reset (filled with zeros).

Index (hex)	Sub-index (hex)	Name	Data type	Access	Value range			Comment
					Minimum	Maximum	Default	
2200	--	Activation	record		--	--	--	
	00	No. of sub-indexes	word (2 bytes)	ro	0 _d	5 _d	0 _d	Number of sub-indexes
	01	Mode	byte	rw	0 _d	1 _d	0 _d	Communication mode
	02	Number of results	byte	ro	0 _d	255 _d	0 _d	Number of results
	03	Activation signal	byte	rw	0 _d	1 _d	0 _d	Device activation
	04	Data acknowledgment	byte	rw	0 _d	1 _d	0 _d	Acknowledgment data
	05	Data reset	byte	rw	0 _d	1 _d	0 _d	Data reset

No. of sub-indexes

Specifies the number of sub-indexes.

Mode

The parameter defines the mode in which the communication is operated.

- 0 Standard data output operation (without ACK)
- 1 Handshake operation (with ACK)



Note!

*This setting can only be performed via CoE (startup parameter) in **PreOp** ESM state.*

If multiple results are produced within an activation, the input data of the result data objects is overwritten with the last generated result while in standard data output operation (without ACK). It is possible - dependent on the cycle time - that only the last result is visible on the bus.

In this case, handshake operation (with ACK) must be used. There is otherwise a risk of data loss.

Multiple individual results can be produced within an activation, for example, if the bar code reader detects multiple codes within an activation and interprets the result as valid.

Number of results

This value specifies how many messages are ready to be picked up in the device.

Activation signal

Activation signal for activating the device (opening of the reading gate).

This sub-object is edge-triggered.

- 0 -> 1 Activation (opening of the reading gate)
- 1 -> 0 Deactivation (closing of the reading gate)

Data acknowledgment

This control bit (toggle bit) signals that the transmitted data has been processed by the master. Only relevant in handshake mode (with ACK).

- 0 -> 1 Data has been processed by the master
- 1 -> 0 Data has been processed by the master

Data reset

Deletes results that may have been stored and resets the input data.

- 0 -> 1 Data reset

If the data reset control bit is activated, the following actions are carried out:

1. Deletion of results that may still be stored.
2. Resetting of object 0x2300_h fragmented result, i.e., even a partially transmitted read result is deleted.
3. Deletion of the input data range (result data) of objects 0x2000_h to 0x2007_h. The input data of object 0x2450_h device status and control, is not deleted.

11.4.4.6 Object 0x2300_h Fragmented result

The object 0x2300_h defines the output of fragmented results (direction: from the BCL 338i to control). To occupy few I/O data, the results may be split into several fragments with this object. The fragments can then be transmitted one after another with a handshake.

These settings apply to result data objects 0x2000_h to 0x2007_h.

This object can be used to switch on the fragmentation of the result data. The result data is dependent on the selected result formatting. This can be selected and configured with the webConfig tool.

Index (hex)	Sub-index (hex)	Name	Data type	Access	Value range			Comment
					Minimum	Maximum	Default	
2300	--	Fragmented result	record		--	--	--	Fragmented result
	00	No. of sub-indexes	byte	ro	0 _d	5 _d	0 _d	Number of sub-indexes
	01	Activation of fragmented result	byte	rw	0 _d	1 _d	0 _d	Activation of fragmented result
	02	Fragment length	byte	rw	1 _d	255 _d	1 _d	Fragment length
	03	Fragment no.	byte	ro	0 _d	255 _d	0 _d	Fragment number
	04	Remaining no. of fragments	byte	ro	0 _d	255 _d	0 _d	Remaining fragments
	05	Fragment size	byte	ro	0 _d	255 _d	0 _d	Fragment size

No. of sub-indexes

Specifies the number of sub-indexes.

Activation of fragmented result

This sub-object defines whether or not the result data is to be transmitted fragmented from the device to the control.

- 0 Fragmentation of the result data inactive
- 1 Fragmentation of the result data active



Note!

*This setting can only be performed via CoE (startup parameter) in **PreOp** ESM state.*

Fragment length

The parameter defines the maximum length (in bytes) of the result information per fragment.

Permissible value range: 1_d ... 255_d bytes

**Note!**

*This setting can only be performed via CoE (startup parameter) in **PreOp** ESM state.*

Fragment no.

This sub-object contains the current fragment number of the fragmented result data.

Permissible value range: 0_d ... 255_d bytes

Remaining no. of fragments

This sub-object contains the number of fragments which still have to be read for a complete result.

Permissible value range: 0_d ... 255_d bytes

Fragment size

Fragment size, always corresponds to the configured fragment length, except for the last fragment.

Permissible value range: 0_d ... 255_d bytes

11.4.4.7 Object 0x2400_h Fragmented submission

The object 0x2400_h defines the transfer of fragmented output data (direction: from control to the BCL 338*i*) on the command interpreter in the device. To occupy few I/O data, the output data may be split into several fragments with this object. The fragments can then be transmitted one after another with a handshake.

These settings apply to data objects 0x2100_h to 0x2107_h.

This object can be used to switch on the fragmentation of the output data.

Index (hex)	Sub-index (hex)	Name	Data type	Access	Value range			Comment
					Minimum	Maximum	Default	
2400	--	Fragmented submission	record		--	--	--	Fragmented entry
	00	No. of sub-indexes	byte	ro	0 _d	5 _d	0 _d	Number of sub-indexes
	01	Activation of fragmented submission	byte	rw	0 _d	1 _d	0 _d	Activation of fragmented entry
	02	Fragment length	byte	rw	1 _d	255 _d	1 _d	Fragment length
	03	Fragment no.	byte	rw	0 _d	255 _d	0 _d	Fragment number
	04	Remaining no. of fragments	byte	rw	0 _d	255 _d	0 _d	Remaining fragments
	05	Fragment size	byte	rw	0 _d	255 _d	0 _d	Fragment size

No. of sub-indexes

Specifies the number of sub-indexes.

Activation of fragmented submission

This sub-object defines whether or not output data (from the perspective of the control) is to be transmitted fragmented from the control to the BCL 338*i*.

- 0 Fragmentation of the output data inactive
- 1 Fragmentation of the output data active



Note!

*This setting can only be performed via CoE (startup parameter) in **PreOp** ESM state.*

Fragment length

The parameter defines the maximum length (in bytes) of the output information per fragment.

Permissible value range: 1_d ... 255_d bytes



Note!

*This setting can only be performed via CoE (startup parameter) in **PreOp** ESM state.*

Fragment no.

This sub-object contains the current fragment number of the fragmented output data.

Permissible value range: $0_d \dots 255_d$ bytes

Remaining no. of fragments

This sub-object contains the number of fragments which still have to be transmitted for a complete output.

Permissible value range: $0_d \dots 255_d$ bytes

Fragment size

The fragment size should always be identical, except for the last fragment to be transferred.

A fragment size of 0_d means that – independent of sub-object **Activation of fragmented submission** – the fragmentation of the output data is not used and is switched off.

Permissible value range: $0_d \dots 255_d$ bytes

**Note!**

*If fragmentation of the output data is used, it must always be ensured on the application side for each fragment that is to be transmitted that the output data for this object (from the perspective of the control) is set **before** the toggle bit of the output data (object index 2150_h , sub-index 4_h) is toggled.*

11.4.4.8 Object 0x2450_h Device status and control

The object 0x2450_h contains the display of the device status as well as control bits for triggering a reset or putting the device into standby mode.

Index (hex)	Sub-index (hex)	Name	Data type	Access	Value range			Comment
					Minimum	Maximum	Default	
2450	--	Device status and control	record		--	--	--	Device status and control
	00	No. of sub-indexes	byte	ro	0 _d	4 _d	4 _d	Number of sub-indexes
	01	Device status	byte	ro	0 _d	129 _d	0 _d	Device status BCL 338i
	02	Error acknowledge (toggle)	byte	rw	0 _d	1 _d	0 _d	Error acknowledgment
	03	System reset	byte	ro	0 _d	1 _d	0 _d	System reset restart
	04	Standby	byte	ro	0 _d	1 _d	0 _d	Activation standby

No. of sub-indexes

Specifies the number of sub-indexes.

Device status

This byte represents the device status.

10 _d	Standby
11 _d	Service
15 _d	Device is ready
128 _d	Error
129 _d	Warning

Error acknowledge (toggle)

This control bit confirms and deletes errors or warnings that may be present in the system. It acts like a toggle bit.

0 -> 1	Error acknowledged
1 -> 0	Error acknowledged

System reset

The control bit triggers a system reset (see chapter 12.1.2 "Online commands for system control", 'H' command) if the bit changes from 0 to 1. Activation of this bit triggers a restart of all electronics including the communication stack. Upon completion of the restart, this bit is reset to 0 by the BCL 338i.

0	Run
0 -> 1	System reset

Standby

This control bit activates the standby function of the bar code reader.

0	Standby off
1	Standby on

**Note!**

*During a data reset (see object 0x2200_h sub-index 05_h), the status data of this object is **not** deleted*

11.5 Communication examples

11.5.1 Application case: Reading a bar code

Read and transmit two bar codes in fragmented mode.

Object configuration:

Object 0x2200_h Activation, mode = 1 handshake operation (with ACK)

Object 0x2300_h Fragmented result, fragment length = 4

Object 0x2000_h Result data, 16 bytes data length

11.5.2 Application case: Transmitting 'PT' sequences

With the help of an output data object, commands are transmitted to the command interpreter of the BCL 338i. The control receives the responses from the BCL 338i via a result object.

Specifically, the following 'PT' sequence is to be sent to the BCL 338i:
PT000400080101020000000000

Object configuration:

Object 0x2200_h Activation, mode = 0 standard data output operation (without ACK)

Object 0x2400_h Fragmented submission, fragment length = 16

Object 0x2000_h Result data, 16 bytes data length

Object 0x2100_h Submission data, 16 bytes data length

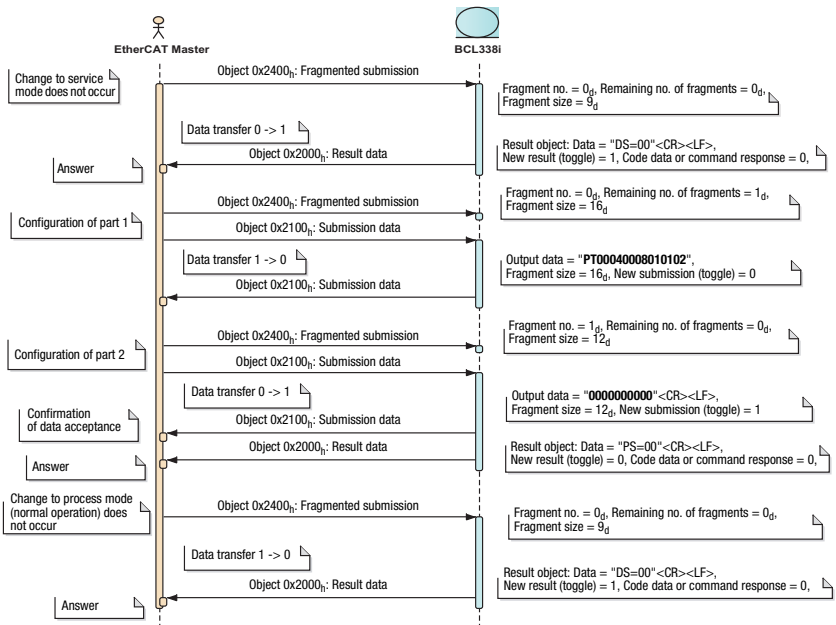


Figure 11.4: Sequence diagram for configuring with 'PT' sequences

12 Online commands

12.1 Overview of commands and parameters

Online commands can be used to send commands directly to the device for control and configuration.

For this purpose, the BCL 338*i* must be connected to a host- or service computer via the interface. The commands described can be sent either via the host or the service interface.

Online commands

With the commands, you can:

- control/decode.
- read/write/copy parameters.
- carry out an automatic configuration.
- teach-in/set reference codes.
- call up error messages.
- call up statistical device information.
- carry out a software reset in order to reinitialize the device.

Syntax

Online commands consist of one or two ASCII characters followed by command parameters.

No separation characters may be entered between the command and the command parameter(s). Both small and capitalized letters can be used.

Example:

Command '**CA**': autoConfig function

Parameter '**+**': Activation

Transmitted is: '**CA+**'

Notation

Commands, command parameters and returned data are enclosed between single quotation marks ' ' in the text of this manual.

Most online commands are acknowledged by the BCL 338*i* and any requested data returned. For commands that are not acknowledged, command execution can be observed or monitored directly on the device.

12.1.1 General online commands

Software version number

Command	'V'
Description	Requests device version information
Parameter	No
Acknowledgment	'BCL 338i SM 100 V 1.1.0 2017-01-15' The first line contains the device type of the BCL 338i, followed by the device version number and version date. (The data which is actually displayed may vary from the values given here.)



Note!

This command returns the major release number of the software packet. This major release number also appears on the display during start-up.

This command can be used to check whether the connected host or service computer is properly connected and configured. If you do not receive an acknowledgment, please check interface connections, protocol and service switches.

Software reset

Command	'H'
Description	Carries out a software reset. The device is restarted and reinitialized, leaving it in the same state as when the supply voltage is switched on.
Parameter	No
Acknowledgment	'S' (start signal)

Code recognition

Command	'CC'
Description	Detects an unknown bar code and outputs number of digits, code type, and code information to the interface, without storing the bar code in the parameter memory.
Parameter	No
Acknowledgment	<p>'xx yy zzzzzz'</p> <p>xx: Code type of the read code</p> <p>'01' 2/5 Interleaved</p> <p>'02' Code 39</p> <p>'03' Code 32</p> <p>'06' UPC (A, E)</p> <p>'07' EAN</p> <p>'08' Code 128, EAN 128</p> <p>'10' EAN Addendum</p> <p>'11' Codabar</p> <p>'12' Code 93</p> <p>'13' GS1 DataBar OMNIDIRECTIONAL</p> <p>'14' GS1 DataBar LIMITED</p> <p>'15' GS1 DataBar EXPANDED</p> <p>yy: Number of digits of the read code</p> <p>zzzzzz: Contents of the decoded label. A – appears if the label was not correctly read.</p>

autoConfig

Command	'CA'
Description	Activates or deactivates the 'autoConfig' function. Certain label reading parameters are programmed automatically in the setup by the labels which the BCL 338 <i>i</i> reads while the 'autoConfig' function is active.
Parameter	'+' Activates 'autoConfig' '/' Rejects the last code read '-' Deactivates 'autoConfig' and stores the decoded data in the current parameter set
Acknowledgment	'CSx' x Status '0' Valid 'CA' command '1' Invalid command '2' autoConfig could not be activated '3' autoConfig could not be deactivated '4' Result could not be deleted
Description	'xx yy zzzzzz' xx Number of digits of the read code yy Code type of the read code '01' 2/5 Interleaved '02' Code 39 '03' Code 32 '06' UPC (A, E) '07' EAN '08' Code 128, EAN 128 '10' EAN Addendum '11' Codabar '12' Code 93 '13' GS1 DataBar OMNIDIRECTIONAL '14' GS1 DataBar LIMITED '15' GS1 DataBar EXPANDED zzzzz: Contents of the decoded label. A – appears if the label was not correctly read.

Alignment mode

Command	'JP'
Description	<p>This command simplifies mounting and alignment of the BCL 338<i>i</i>. After activating the function with 'JP+', the BCL 338<i>i</i> continuously supplies status information to the serial interfaces.</p> <p>With this online command, the scanner is set to terminate the decoding after 100 successfully decoded labels and output the status information. Subsequently, the read process is reactivated automatically.</p> <p>In addition to the output of the status information, the laser beam is used to display the reading quality. Depending on how many read results could be extracted, the duration of the laser's "OFF" time increases.</p> <p>If the reading quality is high, the laser beam flashes in brief, regular intervals. The worse the decoder decodes, the longer the pauses become during which the laser is switched off. The flashing intervals become more and more irregular because the laser may, in total, be active for longer to extract more labels. The duration of the pauses has been stepped in such a way that they can be distinguished by the eye.</p>
Parameter	<p>'+' : Starts the alignment mode. '-' : Ends the alignment mode.</p>
Acknowledgment	<p>'yyy_zzzzzz'</p> <p>yyy: Reading quality in %. A high process availability is ensured at read qualities > 75 %.</p> <p>zzzzz: Bar code information.</p>

Manual definition of the reference code

Command	'RS'
Description	This command can be used to define a new reference code in the BCL 338 <i>i</i> by means of direct input via the serial interface. The data is saved in the parameter set according to your input under reference code 1 through 2 and stored in the working buffer for direct further processing.
Parameter	<p>'RSyvxxzzzzzzz'</p> <p>y, v, x and z are placeholders (variables) for the actual entry.</p> <p>y Defined reference code no.</p> <p> '1' (Code 1)</p> <p> '2' (Code 2)</p> <p>v Storage location for reference code:</p> <p> '0' RAM+EEPROM,</p> <p> '3' RAM only</p> <p>xx Defined code type (see command 'CA')</p> <p>z Defined code information (1 ... 63 characters)</p>
Acknowledgment	<p>'RSx'</p> <p>x Status</p> <p> '0' Valid 'Rx' command</p> <p> '1' Invalid command</p> <p> '2' Insufficient memory for reference code</p> <p> '3' Reference code has not been saved</p> <p> '4' Reference code invalid</p>
Example	Entry = 'RS130678654331' (Code 1 (1), RAM only (3), UPC (06), code information)

Reference code teach-in

Command	'RT'
Description	This command enables a reference code to be defined quickly by reading an example label.
Parameter	'RTy' y Function '1' Defines reference code 1 '2' Defines reference code 2 '+ ' Activates the definition of reference code 1 up to the value of Parameter no_of_labels '- ' Ends the teach event
Acknowledgment	The BCL 338 <i>i</i> first responds with the command 'RS' and corresponding status (see command 'RS'). After a bar code has been read, it sends the result in the following format: 'RCyvxxzzzz' y, v, x and z are placeholders (variables) for the actual entry. y Defined reference code no. '1' (Code 1) '2' (Code 2) v Storage location for reference code '0' RAM+EEPROM, '3' RAM only xx Defined code type (see command 'CA') z Defined code information (1 ... 63 characters)

**Note!**

With this function, only code types are recognized that are identified using the autoConfig function or which were set in the set-up.

✎ After each reading via an RTy command, explicitly switch off the function again since failure to do so will interfere with other commands as well as prevent execution of a new RTx command.

Reading a reference code

Command	'RR'
Description	The command reads out the reference code defined in the BCL 338 <i>i</i> . If no parameters are specified, all defined codes are output.
Parameter	<Reference code number> '1' ... '2' value range of reference codes 1 to 2
Acknowledgment	<p>If no reference codes are defined, the BCL 338<i>i</i> responds with the 'RS' command and corresponding status (see command RS). For valid codes, the output corresponds to the following format:</p> <p>RCyvxxzzzzz</p> <p>y, v, x and z are placeholders (variables) for the actual entry.</p> <p>y Defined reference code no. '1' (Code 1) '2' (Code 2)</p> <p>v Storage location for reference code '0' RAM+EEPROM, '3' RAM only</p> <p>xx Defined code type (see command 'CA')</p> <p>z Defined code information (1 ... 63 characters)</p>

12.1.2 Online commands for system control

Activating sensor input

Command	'+'
Description	<p>The command activates decoding. This command is used to activate the reading gate. It remains active until it is deactivated by one of the following criteria:</p> <ul style="list-style-type: none"> • Deactivation by a manual command • Deactivation by a switching input • Deactivation upon reaching the specified read quality (equal scans) • Deactivation by timeout • Deactivation upon reaching a preset number of scans without information.
Parameter	No
Acknowledgment	None

Deactivating sensor input

Command	'-'
Description	<p>The command activates decoding. This command can be used to deactivate the reading gate. Following deactivation, the read result is output. Because the reading gate was manually deactivated and, thus, no GoodRead criterion was met, a NoRead is output.</p>
Parameter	No
Acknowledgment	None

12.1.3 Online commands for configuring the switching inputs/outputs

Activate switching output

Command	'OA'
Description	The switching outputs 1 and 2 can be activated with this command. The respective port must have been configured as a switching output. The logic state is output, i.e., an inverted logic is taken into account (e.g., inverted logic and a state of High corresponds to a voltage of 0V at the switching output).
Parameter	'OA<a> <a> Selected switching output [1, 2], unit (dimensionless)
Acknowledgment	None

Query the state of the switching outputs

Command	'OA'
Description	This command may be used to query the states of the switching inputs and outputs that are configured as a switching output and that have been set via commands. The logic state is output, i.e., an inverted logic is taken into account (e.g., inverted logic and a state of High corresponds to a voltage of 0V at the switching output).
Parameter	'OA S1=<a>;S2=<a>' <a> State of the switching outputs
Acknowledgment	'0' Low '1' High 'I' Configuration as switching input 'P' Passive configuration

Set the state of the switching outputs

Command	'OA'
Description	This command is used to set the states of the switching inputs/outputs that are configured as a switching output. The logic state is specified, i.e., an inverted logic is taken into account (e.g., inverted logic and a state of High corresponds to a voltage of 0V at the switching output). The values of the switching inputs/outputs that are not configured as switching outputs are ignored. You may also use only a selection of the existing switching inputs/outputs as long as these are listed in ascending order.
Parameter	'OA [S1=<a>];S2=<a>' <a> State of the switching output '0' Low '1' High
Acknowledgment	'OA=<aa>' <aa> Status acknowledgment, unit (dimensionless) '00' ok '01' Syntax error '02' Parameter error '03' Other error

Deactivate switching output

Command	'OD'
Description	The switching outputs 1 and 2 can be deactivated with this command. The respective port must have been configured as a switching output. The logic state is output, i.e., an inverted logic is taken into account (e.g., inverted logic and a state of High corresponds to a voltage of 0V at the switching output).
Parameter	'OD<a>' <a> Selected switching output [1, 2], unit (dimensionless)
Acknowledgment	None

Query the configuration of the switching inputs/outputs

Command	'OF'
Description	This command may be used to query the configuration of the switching inputs/outputs 1 and 2.
Parameter	'OF?'
Acknowledgment	'OF S1=<a>;S2=<a>' <a> Function of the switching input/ output, unit [dimensionless] 'I' Switching input 'O' Switching output 'P' Passive

Configure the switching inputs/ outputs

Command	'OF'
Description	This command may be used to configure the function of the switching inputs/outputs 1 and 2. You may also use only a selection of the existing switching inputs/outputs as long as these are listed in ascending order.
Parameter	'OF [S1=<a>];[;S2=<a>]' <a> Function of the switching input/ output, unit [dimensionless] 'I' Switching input 'O' Switching output 'P' Passive
Acknowledgment	'OF=<bb>' <bb> Status acknowledgment '00' ok '01' Syntax error '02' Parameter error '03' Other error

12.1.4 Online commands for the parameter set operations



Note!

You can obtain detailed information on the parameter set of the bar code reader from Leuze electronic on request.

Copying parameter set

Command	'PC'
Description	This command can only be used to copy parameter sets in their entirety. This can be used to replicate the three parameter sets default , permanent and operating parameters on the basis of one another. In addition, this command can also be used to restore the factory settings.
Parameter	<p>'PC<Source type><Target type>' <Source type>Parameter data set that is to be copied, unit [dimensionless]</p> <p>'0' Parameter data set in permanent memory '2' Default or factory parameter set '3' Operating parameter data set in volatile memory</p> <p><Target type>Parameter set into which the data is to be copied, unit [dimensionless]</p> <p>'0' Parameter data set in permanent memory '3' Operating parameter data set in volatile memory</p> <p>Permissible combinations here include:</p> <p>'03' Copying the data set from the permanent memory to the operating parameter data set '30' Copying the operating parameter data set to the permanent parameter set memory '20' Copying the default parameters to the permanent memory and to the main memory</p>
Acknowledgment	<p>'PS=<aa>' <aa> Status acknowledgment, unit [dimensionless]</p> <p>'00' ok '01' Syntax error '02' Impermissible command length '03' Reserved '04' Reserved '05' Reserved '06' Impermissible combination, source type - target type</p>

Requesting parameter data set from BCL 338i

Command	'PR'
Description	<p>The parameters of the BCL 338<i>i</i> are grouped together in a parameter set and permanently stored in memory. There is one parameter set in permanent memory and one operating parameter set in volatile memory; in addition, there is a default parameter set (factory parameter set) for initialization. This command can be used to edit the first two parameter sets (in permanent and volatile memory). A check sum can be used for reliable parameter transfer.</p>
Parameter	<p>'PR<BCC type><PS type><Address><Data length>[<BCC>]' <BCC type> Check-digit function during transmission, unit [dimensionless] '0' Not used '3' BCC mode 3 <PS type> Memory from which the values are to be read, unit [dimensionless] '0' Parameter values stored in the flash memory '1' Reserved '2' Default values '3' Operating values in RAM <Address> Relative address of the data within the data set 'aaaa' Four-digit, unit [dimensionless] <Data length> Length of the parameter data to be transferred 'bbbb' Four-digit, unit [length in bytes] <BCC> Check sum calculated as specified under BCC type</p>

Command	'PR'
<p>Acknowledgment positive</p>	<p>PT<BCC type><PS type><Status><Start> <Address parameter value><Address+1 parameter value>... [:<Address><Address parameter value>][<BCC>] <BCC type> Check-digit function during transmission, unit [dimensionless] '0' Not used '3' BCC mode 3 <PS type> Memory from which the values are to be read, unit [dimensionless] '0' Parameter values stored in the flash memory '2' Default values '3' Operating values in RAM <Status> Mode of parameter processing, unit [dimensionless] '0' No further parameters '1' Additional parameters follow <Start> Relative address of the data within the data set, 'aaaa' Four-digit, unit [dimensionless] <P.value A.> Parameter value of the parameter stored at this address; the parameter set data 'bb' is converted from HEX format to a 2-byte ASCII-format for transfer. <BCC> Check sum calculated as specified under BCC type,</p>
<p>Acknowledgment negative</p>	<p>'PS=<aa>' Parameter reply: <aa> Status acknowledgment, unit [dimensionless] '01' Syntax error '02' Impermissible command length '03' Impermissible value for checksum type '04' Invalid check sum received '05' Impermissible number of data requested '06' Requested data does not (any longer) fit in the transmis- sion buffer '07' Impermissible address value '08' Read access after end of data set '09' Impermissible QPF data set type</p>

Determining parameter set difference to default parameters

Command	'PD'
Description	<p>This command outputs the difference between the default parameter set and the operating parameter set or the difference between the default parameter set and the permanent parameter set.</p> <p>Comment: The reply supplied by this command can e.g. be directly used for programming a device with factory settings, whereby this device receives the same configuration as the device on which the PD-sequence was executed.</p>
Parameter	<p>'PD<P.set1><P.set2>' <P.set1> Parameter data set which is to be copied, unit [dimensionless] '0' Parameter data set in permanent memory '2' Default or factory parameter set <P.set2> Parameter set to which the data is to be copied, unit [dimensionless] '0' Parameter data set in permanent memory '3' Operating parameter data set in volatile memory Permissible combinations here include: '20' Output of the parameter differences between the default and the permanently saved parameter set '23' Output of the parameter differences between the default parameter set and the operating parameter set saved in volatile memory '03' Output of the parameter differences between the permanent parameter set and the operating parameter set saved in volatile memory</p>
Acknowledgment positive	<p>PT<BCC><PS type><Status><Adr.><P.value adr.><P.valueAdr.+1>... [;<Adr.><P.value adr.>] <BCC> '0' No check digit '3' BCC mode 3 <PS type> '0' Values stored in flash memory '3' Operating values stored in RAM <Status> '0' No further parameters '1' Additional parameters follow <Adr.> Relative address of the data within the data set 'aaaa' Four-digit, unit [dimensionless] <P.value> Parameter value of the -bb- parameter stored at this address. The parameter set data is converted from HEX format to a 2-byte-ASCII format for transfer.</p>

Command	'PD'
Acknowledgment negative	'PS=<aa>'
	<aa> Status acknowledgment, unit [dimensionless]
	'0' No difference
	'1' Syntax error
	'2' Impermissible command length
	'6' Impermissible combination, parameter set 1 and parameter set 2
'8' Invalid parameter set	

Writing parameter set

Command	'PT'
Description	<p>The parameters of the BCL 338<i>i</i> are grouped together in a parameter set and permanently stored in memory. There is one parameter set in permanent memory and one operating parameter set in volatile memory; in addition, there is a default parameter set (factory parameter set) for initialization. This command can be used to edit the first two parameter sets (in permanent and volatile memory). A check sum can be used for reliable parameter transfer.</p>
Parameter	<p>PT<BCC type><PS type><Status><Adr.><P.value adr.><P.value adr+1>...[;<Adr.><P.value adr.>][<BCC>] <BCC type> Check-digit function during transfer, unit [dimensionless] '0' No check digit '3' BCC mode 3 <PS type> Memory from which the values are to be read, unit [dimensionless] '0' Parameter values stored in the flash memory '3' Operating values stored in RAM <Status> Mode of parameter processing, without function here, unit [dimensionless] '0' No reset after parameter change, no further parameters follow '1' No reset after parameter change, additional parameters follow '2' With reset after parameter change, no further parameters '6' Set parameters to factory settings, no further parameters '7' Set parameters to factory settings, lock all code types; the code-type setting must follow in the command! <Adr.> Relative address of the data within the data set, 'aaaa' Four-digit, unit [dimensionless] <P.value> Parameter value of the -bb- parameter stored at this address. The parameter set data is converted from HEX format to a 2-byte-ASCII format for transfer. <BCC> Check sum calculated as specified under BCC type</p>

Command	'PT'
Acknowledgment	'PS=<aa>'
	Parameter reply:
	<aa> Status acknowledgment, unit [dimensionless]
	'01' Syntax error
	'02' Impermissible command length
	'03' Impermissible value for checksum type
	'04' Invalid check sum received
	'05' Impermissible data length
	'06' Invalid data (parameter limits violated)
	'07' Invalid start address
'08' Invalid parameter set	
'09' Invalid parameter set type	

13 Diagnostics and troubleshooting

13.1 General causes of errors

Error	Possible error causes	Measures
Status LED PWR		
Off	<ul style="list-style-type: none"> No supply voltage connected to the device Hardware error 	<input type="checkbox"/> Check supply voltage <input type="checkbox"/> Send device to customer service
Red, flashing	<ul style="list-style-type: none"> Warning 	<input type="checkbox"/> Query diagnostic data and carry out the resulting measures
Red, continuous light	<ul style="list-style-type: none"> Error: no function possible 	<input type="checkbox"/> Internal device error, send in device
Orange, continuous light	<ul style="list-style-type: none"> Device in service mode 	<input type="checkbox"/> Reset service mode with webConfig tool
Status LED NET		
Off	<ul style="list-style-type: none"> No supply voltage connected to the device EtherCAT communication not initialized or inactive Hardware error 	<input type="checkbox"/> Check supply voltage <input type="checkbox"/> Check EtherCAT connection/system, assign IP address <input type="checkbox"/> Send device to customer service
Red, steady flashing	<ul style="list-style-type: none"> Faulty configuration, device status: PRE-OPERATIONAL 	<input type="checkbox"/> Check configuration
Red, flashing, single flash	<ul style="list-style-type: none"> Local error (e.g., synchronization error) 	<input type="checkbox"/> Check configuration
Red, flashing, double flash	<ul style="list-style-type: none"> Watchdog timeout 	<input type="checkbox"/> Check configuration
Red, continuous light	<ul style="list-style-type: none"> Bus error, no communication established to master 	<input type="checkbox"/> Check network configuration

Table 13.1: General causes of errors

13.2 Interface errors

Error	Possible error causes	Measures
No communication via USB service interface	<ul style="list-style-type: none"> Incorrect interconnection cable Connected BCL 338<i>i</i> is not recognized 	<input type="checkbox"/> Check interconnection cable <input type="checkbox"/> Install USB driver
Sporadic errors at the EtherCAT interface	<ul style="list-style-type: none"> Incorrect wiring Effects due to EMC Overall network expansion exceeded 	<input type="checkbox"/> Check wiring <ul style="list-style-type: none"> In particular, check wire shielding Check the cable used <input type="checkbox"/> Check shielding (shield covering in place up to the clamping point) <input type="checkbox"/> Check grounding concept and connection to functional earth (FE) <input type="checkbox"/> Avoid EMC coupling caused by power cables laid parallel to device lines. <input type="checkbox"/> Check max. network expansion as a function of the max. cable lengths

Table 13.2: Interface error

**Note!**

Please use **Chapter 13 as a master copy** should servicing be required.

Cross the items in the "Measures" column which you have already examined, fill out the following address field and fax the pages together with your service contract to the fax number listed below.

Customer data (please complete)

Device type:	
Company:	
Contact person/department:	
Phone (direct dial):	
Fax:	
Street / no.:	
ZIP code / City:	
Country:	

Leuze Service fax number:

+49 7021 573 - 199

14 Type overview and accessories

14.1 Part number code

BCL 300 <i>i</i> OM100D H	
Heating option	H = With heating
Display option	D = With display and two control buttons
Beam exit	0 Lateral
	2 At the front
Optics	N High Density (close)
	M Medium Density (medium distance)
	F Low Density (remote)
	L Long Range (very large distances)
	J Inkjet print applications
Scanning principle	S Line scanner (single line)
	R1 Line scanner (raster)
	O Oscillating-mirror scanner
	<i>i</i> = integrated fieldbus technology
Interface	00 RS 232/RS 422 (stand-alone)
	01 RS 485 (multiNet slave)
	04 PROFIBUS DP
	08 ETHERNET TCP/IP, UDP
	38 EtherCAT
	48 PROFINET-IO RT
	58 EtherNet/IP
BCL Bar code reader	

Tabelle 14.1: BCL 338*i* part number code

14.2 BCL 338*i* type overview

Network participants with 2x EtherCAT interface:

Type designation	Description	Part no.
Single line scanner with frontal beam exit		
BCL 338 <i>i</i> S N 102	with N optics	50135022
BCL 338 <i>i</i> S M 102	with M optics	50135023
BCL 338 <i>i</i> S F 102	with F optics	50135024
BCL 338 <i>i</i> S L 102	with L optics	50135025
BCL 338 <i>i</i> S N 102 D	with N optics and display	50135026
BCL 338 <i>i</i> S M 102 D	with M optics and display	50135027
BCL 338 <i>i</i> S F 102 D	with F optics and display	50135028
BCL 338 <i>i</i> S L 102 D	with L optics and display	50135029
BCL 338 <i>i</i> S N 102 D H	with N optics, display and heating	50135030
BCL 338 <i>i</i> S M 102 D H	with M optics, display and heating	50135031
BCL 338 <i>i</i> S F 102 D H	with F optics, display and heating	50135032
BCL 338 <i>i</i> S L 102 D H	with L optics, display and heating	50135033
Raster scanner with frontal beam exit		
BCL 338 <i>i</i> R1 N 102	with N optics	50135034
BCL 338 <i>i</i> R1 M 102	with M optics	50135035
BCL 338 <i>i</i> R1 F 102	with F optics	50135036
BCL 338 <i>i</i> R1 N 102 D	with N optics and display	50135037
BCL 338 <i>i</i> R1 M 102 D	with M optics and display	50135038
BCL 338 <i>i</i> R1 F 102 D	with F optics and display	50135039
Single line scanner with deflecting mirror		
BCL 338 <i>i</i> S N 100	with N optics	50135040
BCL 338 <i>i</i> S M 100	with M optics	50135041
BCL 338 <i>i</i> S F 100	with F optics	50135042
BCL 338 <i>i</i> S L 100	with L optics	50135043
BCL 338 <i>i</i> S N 100 D	with N optics and display	50135044
BCL 338 <i>i</i> S M 100 D	with M optics and display	50135045
BCL 338 <i>i</i> S F 100 D	with F optics and display	50135046
BCL 338 <i>i</i> S L 100 D	with L optics and display	50135047
BCL 338 <i>i</i> S N 100 D H	with N optics, display and heating	50135048
BCL 338 <i>i</i> S M 100 D H	with M optics, display and heating	50135049
BCL 338 <i>i</i> S F 100 D H	with F optics, display and heating	50135050
BCL 338 <i>i</i> S L 100 D H	with L optics, display and heating	50135051
Raster scanner with deflecting mirror		
BCL 338 <i>i</i> R1 N 100	with N optics	50135052
BCL 338 <i>i</i> R1 M 100	with M optics	50135053
BCL 338 <i>i</i> R1 F 100	with F optics	50135054
BCL 338 <i>i</i> R1 J 100	with J optics	50135055
BCL 338 <i>i</i> R1 N 100 D	with N optics and display	50135056
BCL 338 <i>i</i> R1 M 100 D	with M optics and display	50135057
BCL 338 <i>i</i> R1 F 100 D	with F optics and display	50135058
Oscillating-mirror scanner		
BCL 338 <i>i</i> O M 100	with M optics	50135059
BCL 338 <i>i</i> O F 100	with F optics	50135060
BCL 338 <i>i</i> O L 100	with L optics	50135061
BCL 338 <i>i</i> O M 100 D	with M optics and display	50135062
BCL 338 <i>i</i> O F 100 D	with F optics and display	50135063
BCL 338 <i>i</i> O L 100 D	with L optics and display	50135064
BCL 338 <i>i</i> O M 100 D H	with M optics, display and heating	50135065
BCL 338 <i>i</i> O F 100 D H	with F optics, display and heating	50135066
BCL 338 <i>i</i> O L 100 D H	with L optics, display and heating	50135067

Table 14.2: BCL 338*i* type overview

14.3 Accessories - Connection hoods

Type designation	Description	Part no.
MS 338	Connector hood for BCL 338 <i>i</i>	50134930
MK 338	Terminal hood for BCL 338 <i>i</i>	50134931
ME 338 103	Connection hood for BCL 338 <i>i</i> , 3 x M12	50134929
ME 338 104	Connection hood for BCL 338 <i>i</i> , 3 x M12, 1 x M8	50134927
ME 338 214	Connection hood for BCL 338 <i>i</i> , 1x M12, 1x M8, 2x RJ45	50134928

Table 14.3: Connection hoods for the BCL 338*i*

14.4 Accessories – Connectors

Type designation	Description	Part no.
KD 095-5A	M12 axial socket for voltage supply, shielded	50020501
D-ET1	RJ45 connector for user-configuration	50108991
S-M12A-ET	M12 axial plug, D-coded, for user-configuration	50112155
KDS ET M12 / RJ 45 W - 4P	Converter from M12, D-coded, to RJ 45 socket	50109832

Table 14.4: Connectors for the BCL 338*i*

14.5 Accessory USB cable

Type designation	Description	Part no.
KB USBa-USBminiB	USB service cable, 2 Type A and Mini-B type connector, length 1 m	50117011

Table 14.5: Service cable for the BCL 338*i*

14.6 Accessories – Mounting device

Type designation	Description	Part no.
BT 56	Mounting device for rod	50027375
BT 59	Mounting device for ITEM	50111224
BT 300 W	Mounting bracket	50121433
BT 300 - 1	Mounting bracket for rod	50121434

Table 14.6: Mounting devices for the BCL 338*i*

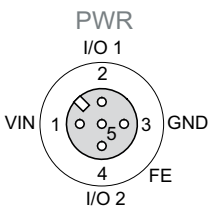
14.7 Accessory - Reflector for AutoReflAct

Type designation	Description	Part no.
Reflective tape no. 4 / 100 x 100 mm	Reflective tape as reflector for AutoReflAct operation	50106119

Table 14.7: Reflector for autoReflAct operation

14.8 Accessory - Ready-made cables for voltage supply

14.8.1 Contact assignment of PWR connection cable

PWR connection cable (5-pin socket, A-coded, not shielded)			
 <p>M12 socket (A-coded)</p>	Pin	Name	Core color
	1	VIN	Brown
	2	I/O 1	White
	3	GND	Blue
	4	I/O 2	Black
	5	FE	Gray
	Thread	FE	Bare



Note!

These cables are not shielded.

14.8.2 Technical data of the cables for voltage supply

Operating temperature range	in rest state:	-30°C ... +70°C
	in motion:	5°C ... +70°C
Material	sheathing:	PVC
Bending radius		> 50mm

14.8.3 Order codes of the cables for voltage supply

Type designation	Description	Part no.
KD U-M12-5A-V1-050	M12 socket for PWR, axial plug outlet, open cable end, cable length 5m, not shielded	50132079
KD U-M12-5A-V1-100	M12 socket for PWR, axial plug outlet, open cable end, cable length 10m, not shielded	50132080

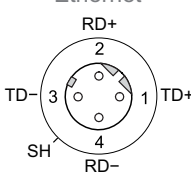
Table 14.8: PWR cable for the BCL 338*i*

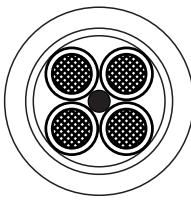
14.9 Accessory - Ready-made cables for bus connection

14.9.1 General information

- Cable for connecting to EtherCAT using M12 connector
- Standard cable available in lengths from 2 ... 30m
- Special cable on request.

14.9.2 Contact assignment of M12 EtherCAT connection cable


M12 EtherCAT connection cable (4-pin connector, D-coded, on both sides)			
Ethernet	Pin	Name	Core color
 <p>M12 plug (D-coded)</p>	1	TD+	Yellow
	2	RD+	White
	3	TD-	Orange
	4	RD-	Blue
	SH (thread)	FE	Bare



Core colors

WH
YE
BU
OG

Conductor class: VDE 0295, EN 60228, IEC 60228 (Class 5)



Shielding contact via connector housing!

Figure 14.1: Cable construction of EtherNet/IP connection cable

14.9.3 Technical data for M12 EtherCAT connection cable

Operating temperature range	In idle state: -50°C ... +80°C
	In motion: -25°C ... +80°C
	In motion: -25°C ... +60°C (when used with drag chains)
Material	Cable sheath: PUR (green), wire insulation: PE foam, Free of halogens, silicone and PVC
Bending radius	> 65mm, suitable for drag chains
Bending cycles	> 10 ⁶ , perm. acceleration < 5m/s ²

14.9.4 Order codes for M12 EtherCAT connection cable

Type designation	Description	Part no.
M12 plug for BUS IN, axial connector, open cable end		
KS ET-M12-4A-P7-020	Cable length 2m	50135073
KS ET-M12-4A-P7-050	Cable length 5m	50135074
KS ET-M12-4A-P7-100	Cable length 10m	50135075
KS ET-M12-4A-P7-150	Cable length 15m	50135076
KS ET-M12-4A-P7-300	Cable length 30m	50135077
M12 plug for BUS IN to RJ-45 plug		
KSS ET-M12-4A-RJ45-A-P7-020	Cable length 2m, cable 1:1, not crossed	50135080
KSS ET-M12-4A-RJ45-A-P7-050	Cable length 5m, cable 1:1, not crossed	50135081
KSS ET-M12-4A-RJ45-A-P7-100	Cable length 10m, cable 1:1, not crossed	50135082
KSS ET-M12-4A-RJ45-A-P7-150	Cable length 15m, cable 1:1, not crossed	50135083
KSS ET-M12-4A-RJ45-A-P7-300	Cable length 30m, cable 1:1, not crossed	50135084
M12 plug + M12 plug for BUS OUT to BUS IN		
KSS ET-M12-4A-M12-4A-P7-020	Cable length 2m, cable 1:1, not crossed	50137077
KSS ET-M12-4A-M12-4A-P7-050	Cable length 5m, cable 1:1, not crossed	50137078
KSS ET-M12-4A-M12-4A-P7-100	Cable length 10m, cable 1:1, not crossed	50137079
KSS ET-M12-4A-M12-4A-P7-150	Cable length 15m, cable 1:1, not crossed	50137080

Table 14.9: Bus connection cables for the BCL 338*f*

15 Maintenance

15.1 General maintenance information

Usually, the BCL 338*i* bar code reader does not require any maintenance by the operator.

Cleaning

Clean glass surface with a damp sponge soaked in commercial cleaning detergent. Then rub it with a soft, clean, dry cloth.



Note!

Do not use aggressive cleaning agents such as thinner or acetone for cleaning the device. Use of improper cleaning agents can damage the housing window.

15.2 Repairs, servicing

Repairs to the device must only be carried out by the manufacturer.

↳ *Contact your Leuze distributor or service organization should repairs be required. The addresses can be found on the inside of the cover and on the back.*



Note!

When sending devices to Leuze electronic for repair, please provide an accurate description of the error.

15.3 Disassembling, packing, disposing

Repacking

For later reuse, the device is to be packed so that it is protected.



Note!

Electrical scrap is a special waste product! Observe the locally applicable regulations regarding disposal of the product.

16 Appendix

16.1 Declarations of Conformity




 the sensor people		
EG-KONFORMITÄTS-ERKLÄRUNG	EC DECLARATION OF CONFORMITY	DECLARATION CE DE CONFORMITE
Hersteller:	Manufacturer:	Constructeur:
	Leuze electronic GmbH + Co. KG In der Braike 1, PO Box 1111 73277 Owen, Germany	
Produktbeschreibung:	Description of product:	Description de produit:
Stationärer Barcodeleser BCL 3xxi	Stationary bar code reader BCL 3xxi	Lecteur de code à barres stationnaire BCL 3xxi
Die alleinige Verantwortung für die Ausstellung dieser Konformitätserklärung trägt der Hersteller.	This declaration of conformity is issued under the sole responsibility of the manufacturer.	La présente déclaration de conformité est établie sous la seule responsabilité du fabricant.
Der oben beschriebene Gegenstand der Erklärung erfüllt die einschlägigen Harmonisierungsrechtsvorschriften der Union:	The object of the declaration described above is in conformity with the relevant Union harmonisation legislation:	L'objet de la déclaration décrit ci-dessus est conforme à la législation d'harmonisation de l'Union applicable:
Angewandte EG-Richtlinie(n):	Applied EC Directive(s):	Directive(s) CE appliquées:
2004/108/EG (bis 19.04.16) 2014/30/EG (ab 20.04.16) 2006/95/EG (bis 19.04.16) 2014/35/EG (ab 20.04.16)	2004/108/EC (till 19.04.16) 2014/30/EC (from 20.04.16) 2006/95/EC (till 19.04.16) 2014/35/EC (from 20.04.16)	2004/108/CE (Jusqu'à 19.04.16) 2014/30/CE (du 20.04.16) 2006/95/CE (Jusqu'à 19.04.16) 2014/35/CE (du 20.04.16)
Angewandte Normen:	Applied standards:	Normes appliquées:
EN 55022: 2010 + AC: 2011 FCC15 - CFR 47 Part 15: 2015	EN 61000-6-2: 2005 + AC: 2005 EN 60825-1: 2007	EN 61000-6-3: 2007 + A1: 2011 + AC: 2012
<small>2014/00/EG veröffentlicht: 29.03.2014, EU-Amtsblatt Nr. L 96/79-106; 2014/30/EC published: 29.03.2014, EU-Journal No. L 96/79-106; 2014/30/CE publié: Journal EU n° L 96/79-106 2014/35/EG veröffentlicht: 29.03.2014, EU-Amtsblatt Nr. L 96/357-374; 2014/35/EC published: 29.03.2014, EU-Journal No. L 96/357-374; 2014/35/CE publié: Journal EU n° L 96/357-374</small>		
<div style="display: flex; justify-content: space-between; align-items: center;"> <div style="text-align: center;"> <p style="font-size: 2em; color: blue;">29.1.2016</p> <p>Datum / Date / Date</p> </div> <div style="text-align: center;">  <p>Ulrich Ballbach, Geschäftsführer / Managing Director / Gérant</p> </div> </div>		
<small>Leuze electronic GmbH + Co. KG In der Braike 1 D-73277 Owen Telefon +49 (0) 7021 573-0 Telefax +49 (0) 7021 573-199 info@leuze.de www.leuze.com LEO-ZQM-148-06-FO</small>	<small>Leuze electronic GmbH + Co. KG, 81638 Stuttgart, HRB 230712 Persönlich haftende Gesellschafterin Leuze electronic Geschäftsbearbeitungs GmbH, Sitz Owen, Registergericht Stuttgart, HRB 230559 Geschäftsführer: Ulrich Sybach USt-IdNr. DE 145912522 Zolnummer 254232 Es gelten ausschließlich unsere aktuellen Verkaufs- und Lieferbedingungen Only our current Terms and Conditions of Sale and Delivery shall apply.</small>	

Figure 16.1: BCL 338i Declaration of Conformity



 the <i>sensor</i> people		
<p>EG-KONFORMITÄTS-ERKLÄRUNG</p>	<p>EC DECLARATION OF CONFORMITY</p>	<p>DECLARATION CE DE CONFORMITE</p>
<p>Hersteller:</p>	<p>Manufacturer:</p>	<p>Constructeur:</p>
<p>Leuze electronic GmbH + Co. KG In der Braike 1, PO Box 1111 73277 Owen, Germany</p>		
<p>Produktbeschreibung:</p>	<p>Description of product:</p>	<p>Description de produit:</p>
<p>Modulare Steckerhaube MS 3xx, Modulare Klemmhaube MK 3xx, Modulare Anschlusseinheit MA 100</p>	<p>Modular hood with integrated connectors MS 3xx, Modular terminal hoods MK 3xx, Modular interfacing unit MA 100</p>	<p>Logement modulaire de prises MS 3xx, Logement modulaire de bornes MK 3xx, Unité modulaire de branchement MA 100</p>
<p>Die alleinige Verantwortung für die Ausstellung dieser Konformitätserklärung trägt der Hersteller.</p>	<p>This declaration of conformity is issued under the sole responsibility of the manufacturer.</p>	<p>La présente déclaration de conformité est établie sous la seule responsabilité du fabricant.</p>
<p>Der oben beschriebene Gegenstand der Erklärung erfüllt die einschlägigen Harmonisierungsrechtsvorschriften der Union:</p>	<p>The object of the declaration described above is in conformity with the relevant Union harmonisation legislation:</p>	<p>L'objet de la déclaration décrit ci-dessus est conforme à la législation d'harmonisation de l'Union applicable:</p>
<p>Angewandte EG-Richtlinie(n): 2004/108/EG (bis 19.04.16) 2014/30/EG (ab 20.04.16)</p>	<p>Applied EC Directive(s): 2004/108/EC (till 19.04.16) 2014/30/EC (from 20.04.16)</p>	<p>Directive(s) CE appliquées: 2004/108/CE (jusqu'à 19.04.16) 2014/30/CE (du 20.04.16)</p>
<p>Angewandte harmonisierte Normen / Applied harmonized standards / Normes harmonisées appliquées :</p>		
<p>EN 61000-6-2: 2005 + AC: 2005 EN 61000-6-4: 2007 + A1: 2011</p>		
<p>Angewandte technische Spezifikationen / Applied technical specifications / Spécifications techniques appliquées :</p>		
<p>2014/30/EG veröffentlicht: 29.03.2014, EU-Amtsblatt Nr. L 96/79-106; 2014/30/EC published: 29.03.2014, EU-Journal No. L 96/79-106; 2014/30/CE publié: Journal EU n° L 96/79-106</p>		
<p>25.4.2016 Datum / Date / Date Ulrich Schäbach, Geschäftsführer / Managing Director / Gérant</p>		
<p>Leuze electronic GmbH + Co. KG In der Braike 1 D-73277 Owen Telefon +49 (0) 7021 573-0 Telefax +49 (0) 7021 573-199 info@leuze.de www.leuze.com LEO-ZQM-148-06-F0</p>	<p>Leuze electronic GmbH + Co. KG, Sitz Owen, Registergericht Stuttgart, HRA 230712 Persöndlich haftende Gesamtschuldnerin Leuze electronic Geschäftsführung GmbH, Sitz Owen, Registergericht Stuttgart, HRB 730550 Geschäftsführer: Ulrich Schäbach USt-IdNr: DE 145912521 Zahnnummer 2554232 Es gelten ausschließlich unsere aktuellen Verkaufs- und Lieferbedingungen Only our current Terms and Conditions of Sale and Delivery shall apply</p>	

Figure 16.2: Connection hood / connection unit declaration of conformity

16.2 ASCII character set

ASCII	Dec.	Hex.	Oct.	Designation	Meaning
NUL	0	00	0	ZERO	Zero
SOH	1	01	1	START OF HEADING	Start of heading
STX	2	02	2	START OF TEXT	Start of text characters
ETX	3	03	3	END OF TEXT	Last character of text
EOT	4	04	4	END OF TRANSMISS.	End of transmission
ENQ	5	05	5	ENQUIRY	Request for data trans.
ACK	6	06	6	ACKNOWLEDGE	Positive acknowledgment
BEL	7	07	7	BELL	Bell signal
BS	8	08	10	BACKSPACE	Backspace
HT	9	09	11	HORIZ. TABULATOR	Horizontal tabulator
LF	10	0A	12	LINE FEED	Line feed
VT	11	0B	13	VERT. TABULATOR	Vertical tabulator
FF	12	0C	14	FORM FEED	Form feed
CR	13	0D	15	CARRIAGE RETURN	Carriage return
SO	14	0E	16	SHIFT OUT	Shift out
SI	15	0F	17	SHIFT IN	Shift in
DLE	16	10	20	DATA LINK ESCAPE	Data link escape
DC1	17	11	21	DEVICE CONTROL 1	Device control character 1
DC2	18	12	22	DEVICE CONTROL 2	Device control character 2
DC3	19	13	23	DEVICE CONTROL 3	Device control character 3
DC4	20	14	24	DEVICE CONTROL 4	Device control character 4
NAK	21	15	25	NEG. ACKNOWLEDGE	Negative acknowledge
SYN	22	16	26	SYNCHRONOUS IDLE	Synchronization
ETB	23	17	27	EOF TRANSM. BLOCK	End of data transmission block
CAN	24	18	30	CANCEL	Invalid
EM	25	19	31	END OF MEDIUM	End of medium
SUB	26	1A	32	SUBSTITUTE	Substitution
ESC	27	1B	33	ESCAPE	Escape
FS	28	1C	34	FILE SEPARATOR	File separator
GS	29	1D	35	GROUP SEPARATOR	Group separator
RS	30	1E	36	RECORD SEPARATOR	Record separator
US	31	1F	37	UNIT SEPARATOR	Unit separator
SP	32	20	40	SPACE	Space
!	33	21	41	EXCLAMATION POINT	Exclamation point

ASCII	Dec.	Hex.	Oct.	Designation	Meaning
"	34	22	42	QUOTATION MARK	Quotation mark
#	35	23	43	NUMBER SIGN	Number sign
\$	36	24	44	DOLLAR SIGN	Dollar sign
%	37	25	45	PERCENT SIGN	Percent sign
&	38	26	46	AMPERSAND	Ampersand
'	39	27	47	APOSTROPHE	Apostrophe
(40	28	50	OPEN. PARENTHESIS	Open parenthesis
)	41	29	51	CLOS. PARENTHESIS	Closed parenthesis
*	42	2A	52	ASTERISK	Asterisk
+	43	2B	53	PLUS	Plus sign
,	44	2C	54	COMMA	Comma
-	45	2D	55	HYPHEN (MINUS)	Hyphen
.	46	2E	56	PERIOD (DECIMAL)	Period (decimal)
/	47	2F	57	SLANT	Slant
0	48	30	60	0	Number
1	49	31	61	1	Number
2	50	32	62	2	Number
3	51	33	63	3	Number
4	52	34	64	4	Number
5	53	35	65	5	Number
6	54	36	66	6	Number
7	55	37	67	7	Number
8	56	38	70	8	Number
9	57	39	71	9	Number
:	58	3A	72	COLON	Colon
;	59	3B	73	SEMICOLON	Semicolon
<	60	3C	74	LESS THAN	Less than
=	61	3D	75	EQUALS	Equals
>	62	3E	76	GREATER THAN	Greater than
?	63	3F	77	QUESTION MARK	Question mark
@	64	40	100	COMMERCIAL AT	Commercial AT
A	65	41	101	A	Capital letter
B	66	42	102	B	Capital letter
C	67	43	103	C	Capital letter
D	68	44	104	D	Capital letter

ASCII	Dec.	Hex.	Oct.	Designation	Meaning
E	69	45	105	E	Capital letter
F	70	46	106	F	Capital letter
G	71	47	107	G	Capital letter
H	72	48	110	H	Capital letter
I	73	49	111	I	Capital letter
J	74	4A	112	J	Capital letter
K	75	4B	113	K	Capital letter
L	76	4C	114	L	Capital letter
M	77	4D	115	M	Capital letter
N	78	4E	116	N	Capital letter
O	79	4F	117	O	Capital letter
P	80	50	120	P	Capital letter
Q	81	51	121	Q	Capital letter
R	82	52	122	R	Capital letter
S	83	53	123	S	Capital letter
T	84	54	124	T	Capital letter
U	85	55	125	U	Capital letter
V	86	56	126	V	Capital letter
W	87	57	127	W	Capital letter
X	88	58	130	X	Capital letter
Y	89	59	131	Y	Capital letter
Z	90	5A	132	Z	Capital letter
[91	5B	133	OPENING BRACKET	Opening bracket
\	92	5C	134	REVERSE SLANT	Reverse slant
]	93	5D	135	CLOSING BRACKET	Closing bracket
^	94	5E	136	CIRCUMFLEX	Circumflex
_	95	5F	137	UNDERSCORE	Underscore
`	96	60	140	GRAVE ACCENT	Grave accent
a	97	61	141	a	Lower case letter
b	98	62	142	b	Lower case letter
c	99	63	143	c	Lower case letter
d	100	64	144	d	Lower case letter
e	101	65	145	e	Lower case letter
f	102	66	146	f	Lower case letter
g	103	67	147	g	Lower case letter

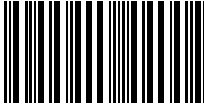
ASCII	Dec.	Hex.	Oct.	Designation	Meaning
h	104	68	150	h	Lower case letter
i	105	69	151	i	Lower case letter
j	106	6A	152	j	Lower case letter
k	107	6B	153	k	Lower case letter
l	108	6C	154	l	Lower case letter
m	109	6D	155	m	Lower case letter
n	110	6E	156	n	Lower case letter
o	111	6F	157	o	Lower case letter
p	112	70	160	p	Lower case letter
q	113	71	161	q	Lower case letter
r	114	72	162	r	Lower case letter
s	115	73	163	s	Lower case letter
t	116	74	164	t	Lower case letter
u	117	75	165	u	Lower case letter
v	118	76	166	v	Lower case letter
w	119	77	167	w	Lower case letter
x	120	78	170	x	Lower case letter
y	121	79	171	y	Lower case letter
z	122	7A	172	z	Lower case letter
{	123	7B	173	OPENING BRACE	Opening brace
	124	7C	174	VERTICAL LINE	Vertical line
}	125	7D	175	CLOSING BRACE	Closing brace
~	126	7E	176	TILDE	Tilde
DEL	127	7F	177	DELETE (RUBOUT)	Delete

16.3 Bar code samples

16.3.1 Module 0.3

Code type 01: Interleaved 2 of 5

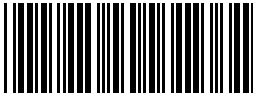
Modul 0,3



1122334455

Code type 02: Code 39

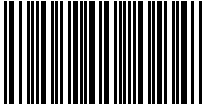
Modul 0,3



135AC

Code type 11: Codabar

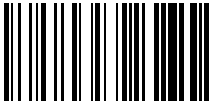
Modul 0,3



A121314A

Code 128

Modul 0,3



abcde

Code type 08: EAN 128

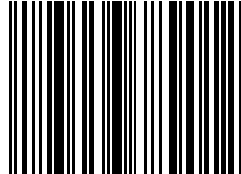
Modul 0,3



leuze

Code type 06: UPC-A

SC 2



1 23456 78901 2

Code type 07: EAN 8

SC 3



34567890

Code type 10: EAN 13 Add-on

SC 0

S



1 122334 455666 77889

Code type 13: GS1 DataBar OMNIDIRECTIONAL



(01) 0 000123 45678 4

Figure 16.3: Bar code sample labels (module 0.3)

16.3.2 Module 0.5

Code type 01: Interleaved 2 of 5

Modul 0,5



Code type 02: Code 39

Modul 0,5



Code type 11: Codabar

Modul 0,5



Code 128

Modul 0,5



Code type 08: EAN 128

Modul 0,5



Code type 06: UPC-A

SC 4



Code type 07: EAN 8

SC 6



Code type 10: EAN 13 Add-on

SC 2



Figure 16.4: Bar code sample labels (module 0.5)