

## Technical data sheet

### Contour measurement system

Part no.: 50143528

CMS748i-0960-0800-0720

#### Contents









- Set consists of
- Technical data
- Dimensioned drawings
- Electrical connection
- Diagrams
- Notes
- Accessories



Figure can vary

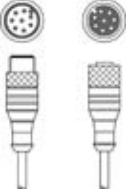

## Set consists of

	Quantity	Part no.	Designation	Article	Description
	6	424417	BT-2P40	Mounting bracket set	Bore hole 1: M6 Bore hole 2: M6 Design of mounting device: Mounting clamp Fastening, at system: Groove mounting Mounting bracket, at device: Groove mounting Type of mounting device: Clampable Material: Metal
	1	50118745	CML730i-R05-720.A/ L-M12	Light curtain receiver	Operating range: 0.1 ... 4.5 m Interface: IO-Link Connection: Connector, M12, Axial, 8 -pin
	1	50118746	CML730i-R05-800.A/ L-M12	Light curtain receiver	Operating range: 0.1 ... 4.5 m Interface: IO-Link Connection: Connector, M12, Axial, 8 -pin
	1	50118748	CML730i-R05-960.A/ L-M12	Light curtain receiver	Operating range: 0.1 ... 4.5 m Interface: PROFINET, IO-Link Connection: Connector, M12, Axial, 8 -pin
	1	50118584	CML730i-T05-720.A- M12	Light curtain transmitter	Operating range: 0.1 ... 4 m Connection: Connector, M12, Axial, 5 -pin
	1	50118585	CML730i-T05-800.A- M12	Light curtain transmitter	Operating range: 0.1 ... 4 m Connection: Connector, M12, Axial, 5 -pin
	1	50118587	CML730i-T05-960.A- M12	Light curtain transmitter	Operating range: 0.1 ... 4 m Connection: Connector, M12, Axial, 5 -pin
	3	50129781	KDS DN-M12-5A- M12-5A-P3-050	Interconnection cable	Suitable for interface: IO-Link, DeviceNet, CANopen Connection 1: Connector, M12, Axial, Female, A-coded, 5 -pin Connection 2: Connector, M12, Axial, Male, A-coded, 5 -pin Shielded: Yes Cable length: 5,000 mm Sheathing material: PUR
	3	50135146	KDS S-M12-8A-M12- 8A-P1-050	Interconnection cable	Connection 1: Connector, M12, Axial, Female, A-coded, 8 -pin Connection 2: Connector, M12, Axial, Male, A-coded, 8 -pin Shielded: Yes Cable length: 5,000 mm Sheathing material: PUR

## Set consists of

	Quantity	Part no.	Designation	Article	Description
	1	50142331	LSC748-000-100	Switch cabinet	Supply voltage: 100 ... 263 V, AC Switching inputs: 4 Piece(s) Switching outputs: 4 Piece(s) Connections: 7 Piece(s)

## Technical data

### Basic data

Series	CMS 7xxi
Contains	1x dongle CMS700
Order guide	Additional models on request

### Functions

Functions	For a minimum object height $\geq 50$ mm
-----------	--

### Optical data

Operating range	Guaranteed operating range
Operating range	0.1 ... 4.5 m
Operating range, transparent media	0.1 ... 1.75 m
Operating range limit	Typical operating range
Operating range limit	0.1 ... 6 m
Measurement field length 1	960 mm
Measurement field length 2	800 mm
Measurement field length 3	720 mm
Beam spacing	5 mm

### Electrical data

Protective circuit	Polarity reversal protection Short circuit protected Transient protection
Output current, continuous current per channel, max.	100 mA

### Performance data

Supply voltage $U_B$	100 ... 263 V, AC
Open-circuit current	250 mA

### Inputs

Number of digital switching inputs	4 Piece(s)
------------------------------------	------------

### Switching inputs

Type	Digital switching input
Voltage type	DC
Switching voltage	24 V, VIN

### Outputs

Number of digital switching outputs	4 Piece(s)
-------------------------------------	------------

### Switching outputs

Type	Digital switching output
Voltage type	AC
Switching voltage	24 V, VIN

### Interface

Type	EtherNet TCP/IP, PROFINET
------	---------------------------

### Ethernet

Function	Configuration / process data
----------	------------------------------

### Profinet

Function	Configuration / process data
----------	------------------------------

### Connection

Number of connections	9 Piece(s)
-----------------------	------------

### Connection 1

Function	Earthing
Type of connection	Earthing strap
Material	Metal

### Connection 2

Function	Voltage supply
Type of connection	Harting connector
Material	Metal

### Connection 3

Function	Length measuring light curtain connection (not in combination with rotary encoder)
Type of connection	Connector
Thread size	M12
Type	Male
Material	Metal
No. of pins	8 -pin
Encoding	A-coded

### Connection 4

Function	Width measuring light curtain connection
Type of connection	Connector
Thread size	M12
Type	Male
Material	Metal
No. of pins	8 -pin
Encoding	A-coded

### Connection 5

Function	Height measuring light curtain connection
Type of connection	Connector
Thread size	M12
Type	Male
Material	Metal
No. of pins	8 -pin
Encoding	A-coded

## Technical data

### Connection 6

Function	Rotary encoder connection (not in combination with length measuring light curtain)
Type of connection	Connector
Thread size	M12
Type	Male
Material	Metal
No. of pins	8 -pin
Encoding	A-coded

### Connection 7

Function	External Ethernet TCP/IP connection
Type of connection	Connector
Thread size	M12
Type	Male
Material	Metal
No. of pins	4 -pin
Encoding	A-coded

### Connection 8

Function	PROFINET IN connection (optional)
Type of connection	Connector
Thread size	M12
Type	Male
Material	Metal
No. of pins	4 -pin
Encoding	A-coded

### Connection 9

Function	PROFINET OUT connection (optional)
Type of connection	Connector
Thread size	M12
Type	Male
Material	Metal
No. of pins	4 -pin
Encoding	A-coded

### Mechanical data

Design	Cubic
Housing material	Metal
Metal housing	Aluminum
Lens cover material	Plastic
Housing color	Gray
	Red
Note	Dimensions of individual set items, see dimensioned drawings

### Operation and display

Note	This information refers to the switch cabinet
Type of display	LED
Number of LEDs	3 Piece(s)
Type of configuration	performed via webConfig
Operational controls	Rotary switch

### Environmental data

Ambient temperature, operation	0 ... 45 °C
Ambient temperature, storage	-20 ... 70 °C

### Certifications

Certifications	CSA
----------------	-----

### Classification

Customs tariff number	90314990
eCl@ss 5.1.4	27270910
eCl@ss 8.0	27270910
eCl@ss 9.0	27270910
eCl@ss 10.0	27270910
eCl@ss 11.0	27270910
ETIM 5.0	EC002549
ETIM 6.0	EC002549
ETIM 7.0	EC002549

## Dimensioned drawings

All dimensions in millimeters

### Light curtain transmitter and receiver



- |   |  |   |  |
|---|--|---|--|
| A | Beam spacing 5 mm  | L | Profile length 1 = 968 mm<br>Profile length 2 = 808 mm |
| B | Measurement field length 1 = 960 mm<br>Measurement field length 2 = 800 mm | T | Transmitter  |
| F | M6 thread  | R | Receiver   |
| G | Fastening groove   | Y | 2.5 mm   |

## Dimensioned drawings

### Switch cabinet

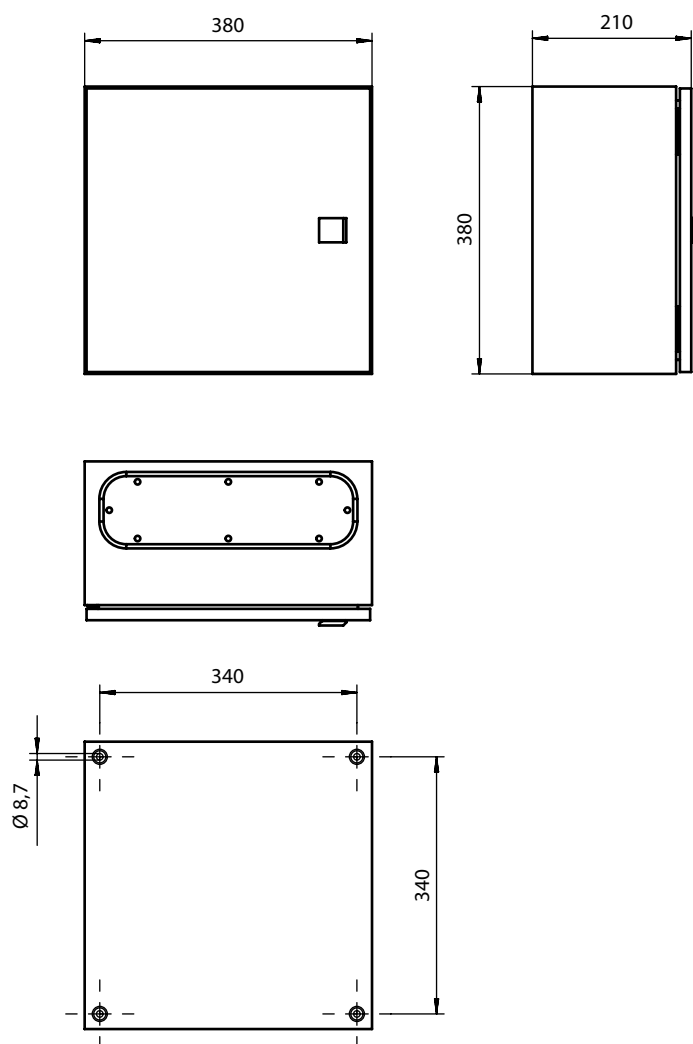

## Dimensioned drawings

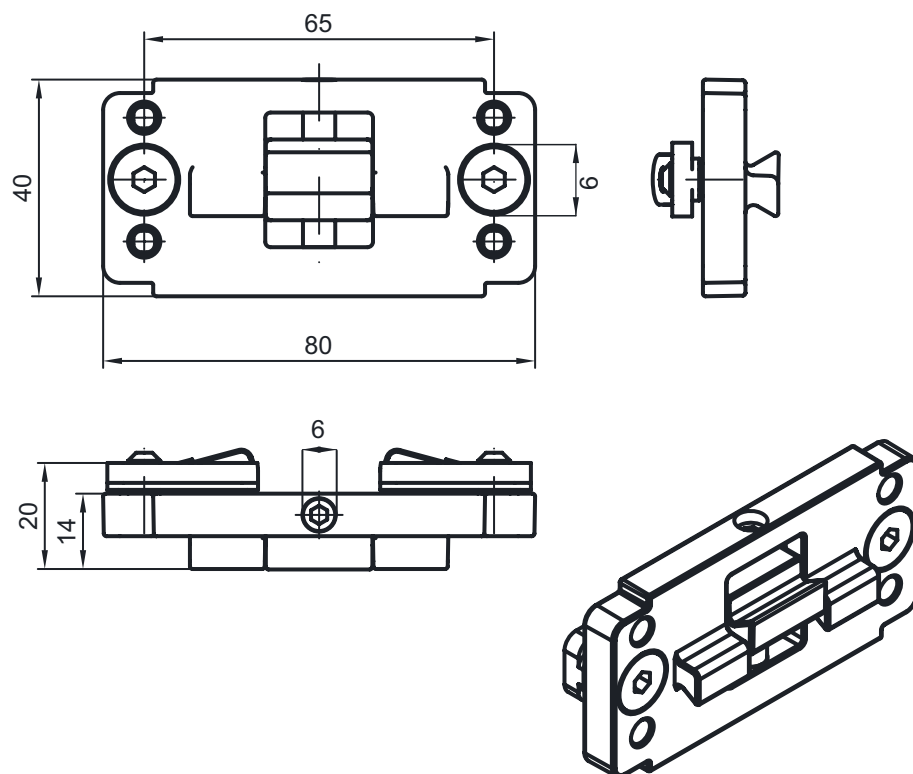

## Electrical connection

### Connection 1

Function	Earthing
Type of connection	Earthing strap
Material	Metal

### Connection 2

### XS1000

Function	Voltage supply
Type of connection	Harting connector
Material	Metal

### Connection 3

### XS1300

Function	Length measuring light curtain connection (not in combination with rotary encoder)
Type of connection	Connector
Thread size	M12
Type	Male
Material	Metal
No. of pins	8 -pin
Encoding	A-coded

## Electrical connection

Pin	Pin assignment
1	V+
2	IO1
3	GND
4	IO-Link
5	IO2
6	IO3
7	IO4
8	GND

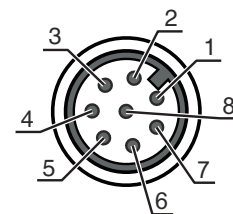

Connection 4	XS1301
Function	Width measuring light curtain connection
Type of connection	Connector
Thread size	M12
Type	Male
Material	Metal
No. of pins	8 -pin
Encoding	A-coded

Pin	Pin assignment
1	V+
2	IO1
3	GND
4	IO-Link
5	IO2
6	IO3
7	IO4
8	GND

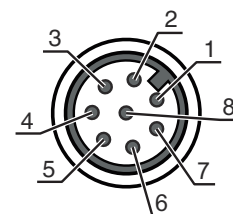

Connection 5	XS1302
Function	Height measuring light curtain connection
Type of connection	Connector
Thread size	M12
Type	Male
Material	Metal
No. of pins	8 -pin
Encoding	A-coded

Pin	Pin assignment
1	V+
2	IO1
3	GND
4	IO-Link
5	IO2
6	IO3
7	IO4
8	GND

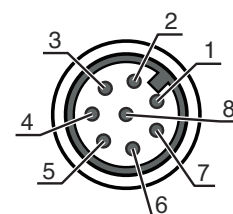



## Electrical connection

### Connection 6

### XS1400

Function	Rotary encoder connection (not in combination with length measuring light curtain)
Type of connection	Connector
Thread size	M12
Type	Male
Material	Metal
No. of pins	8 -pin
Encoding	A-coded

#### Pin Pin assignment

1	U-
2	U+
3	A
4	B
5	N
6	A inv.
7	B inv.
8	N inv.
9	Shield

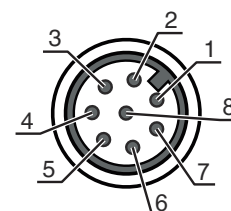

### Connection 7

### XETH1

Function	External Ethernet TCP/IP connection
Type of connection	Connector
Thread size	M12
Type	Male
Material	Metal
No. of pins	4 -pin
Encoding	A-coded

#### Pin Pin assignment

1	TD+
2	RD+
3	TD-
4	RD-

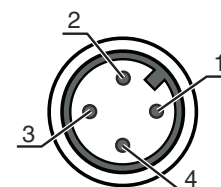

### Connection 8

### XS1100

Function	PROFINET IN connection (optional)
Type of connection	Connector
Thread size	M12
Type	Male
Material	Metal
No. of pins	4 -pin
Encoding	A-coded

#### Pin Pin assignment

1	TD+
2	RD+
3	TD-
4	RD-

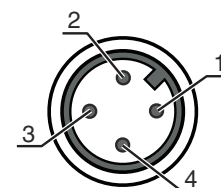

# Electrical connection

## Connection 9

## XS1101

Function	PROFINET OUT connection (optional)
Type of connection	Connector
Thread size	M12
Type	Male
Material	Metal
No. of pins	4 -pin
Encoding	A-coded

Pin	Pin assignment
1	TD+
2	RD+
3	TD-
4	RD-

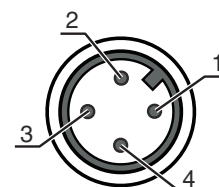

## Diagrams

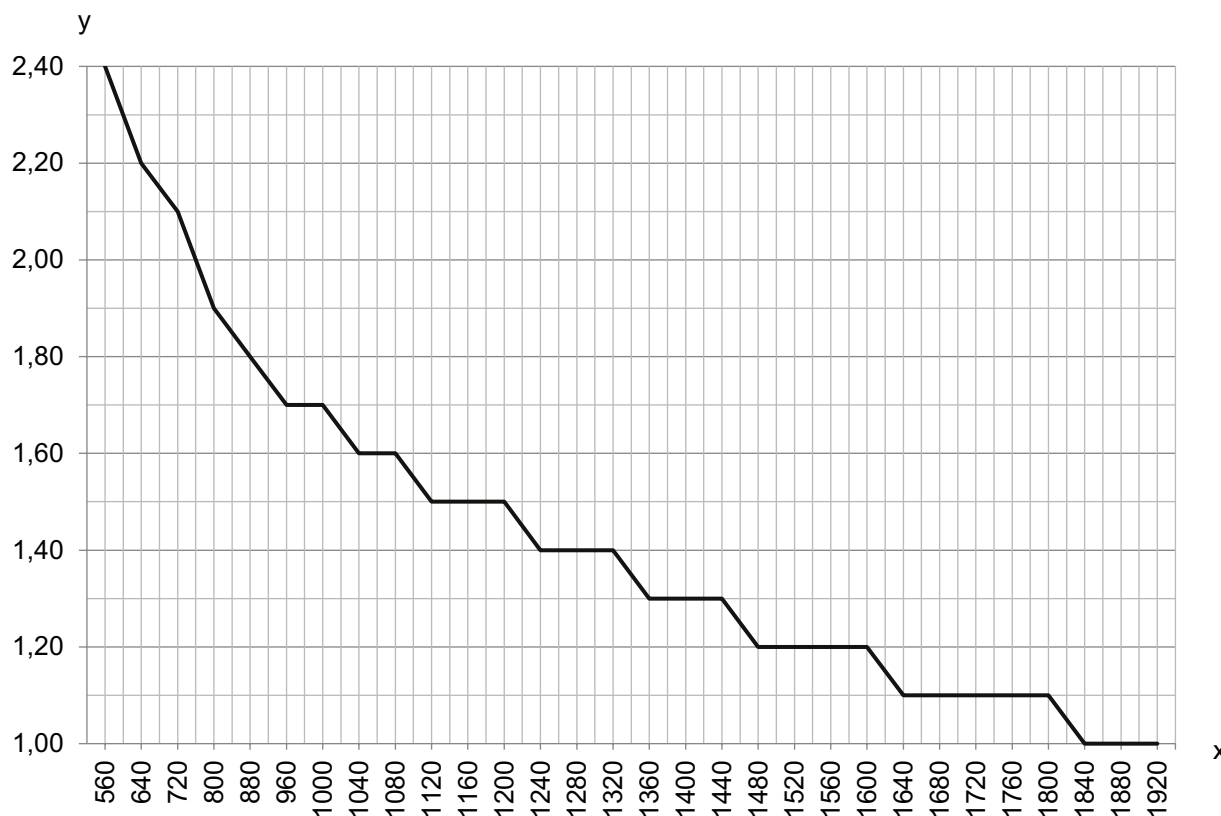

x Total measuring length from width and height measuring light curtain [mm]

y Max. conveyor speed [m/s]

## Notes



### Observe intended use!



- ⚠ This product is not a safety sensor and is not intended as personnel protection.
- ⚠ The product may only be put into operation by competent persons.
- ⚠ Only use the product in accordance with its intended use.

## Accessories

### Connection technology - Interconnection cables

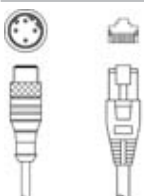
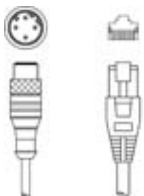
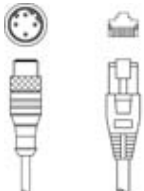
	Part no.	Designation	Article	Description
	50135082	KSS ET-M12-4A-RJ45-A-P7-100	Interconnection cable	Suitable for interface: Ethernet Connection 1: Connector, M12, Axial, Male, D-coded, 4 -pin Connection 2: RJ45 Shielded: Yes Cable length: 10,000 mm Sheathing material: PUR
	50135083	KSS ET-M12-4A-RJ45-A-P7-150	Interconnection cable	Suitable for interface: Ethernet Connection 1: Connector, M12, Axial, Male, D-coded, 4 -pin Connection 2: RJ45 Shielded: Yes Cable length: 15,000 mm Sheathing material: PUR
	50135084	KSS ET-M12-4A-RJ45-A-P7-300	Interconnection cable	Suitable for interface: Ethernet Connection 1: Connector, M12, Axial, Male, D-coded, 4 -pin Connection 2: RJ45 Shielded: Yes Cable length: 30,000 mm Sheathing material: PUR

### Mounting technology - Other

Part no.	Designation	Article	Description
50143670	BT 708M-MRSET	Mounting device set	Design of mounting device: Profile kit Fastening, at system: Screw type / vertical Mounting bracket, at device: Groove mounting Type of mounting device: Rigid Material: Aluminum
50143669	BT 710M-MRSET	Mounting device set	Design of mounting device: Profile kit Fastening, at system: Screw type / vertical Mounting bracket, at device: Groove mounting Type of mounting device: Rigid Material: Aluminum
50142039	BT 712M-MRSET	Mounting device set	Design of mounting device: Profile kit Fastening, at system: Screw type / vertical Mounting bracket, at device: Groove mounting Type of mounting device: Rigid Material: Aluminum

## Accessories

### Note



↪ A list with all available accessories can be found on the Leuze website in the Download tab of the article detailed page.