

## Safety

Products and services  
for machine safety

Safety at Leuze

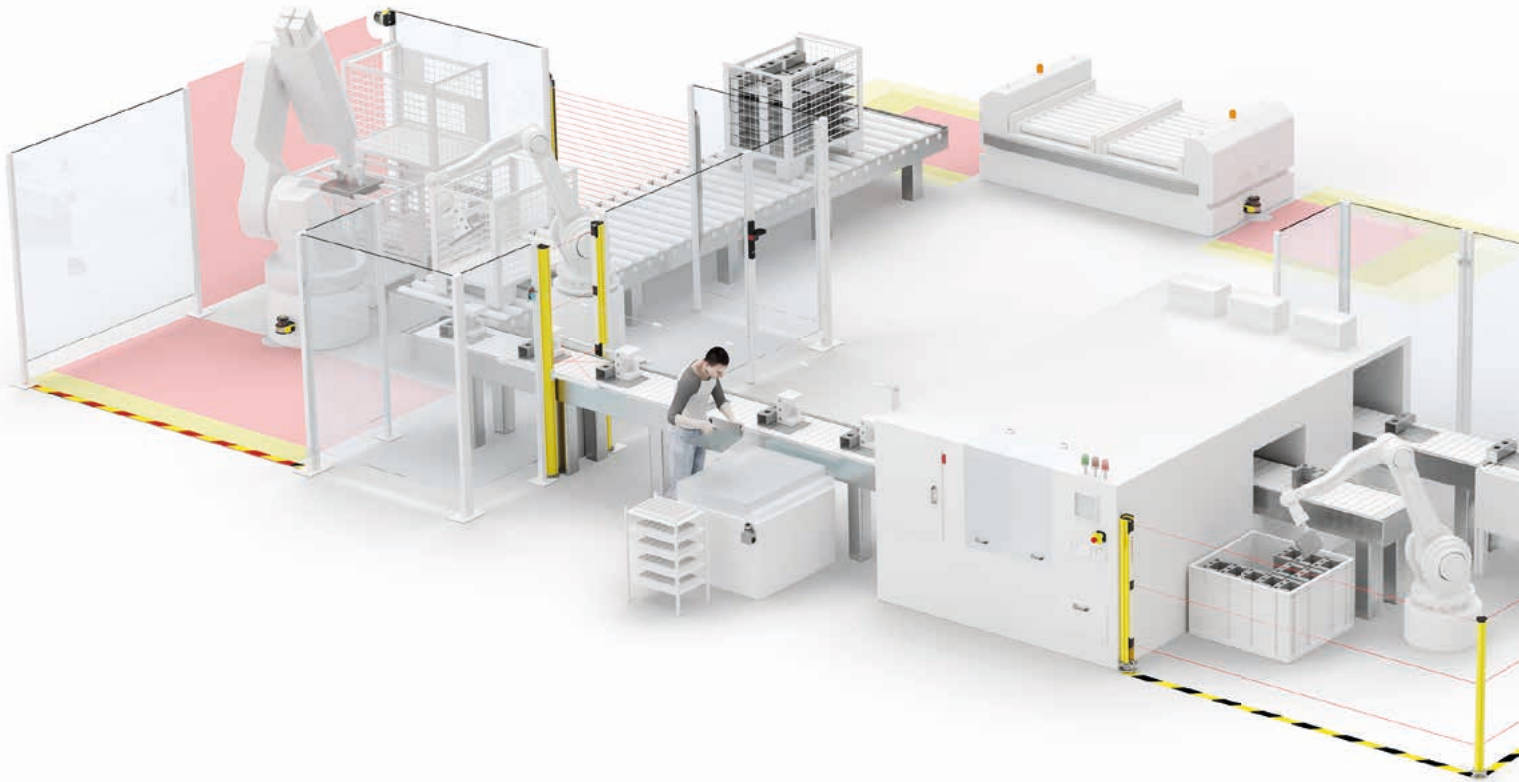



## Products



Safety laser scanner



Safety light curtains /  
with Smart Process Gating



Multiple light beam  
safety devices / with muting



Single light  
beam safety devices



Safety radar sensors



Safety switches



Safety  
proximity sensors



Safety switches with  
guard locking



Safety controls  
and relays



Safety command devices

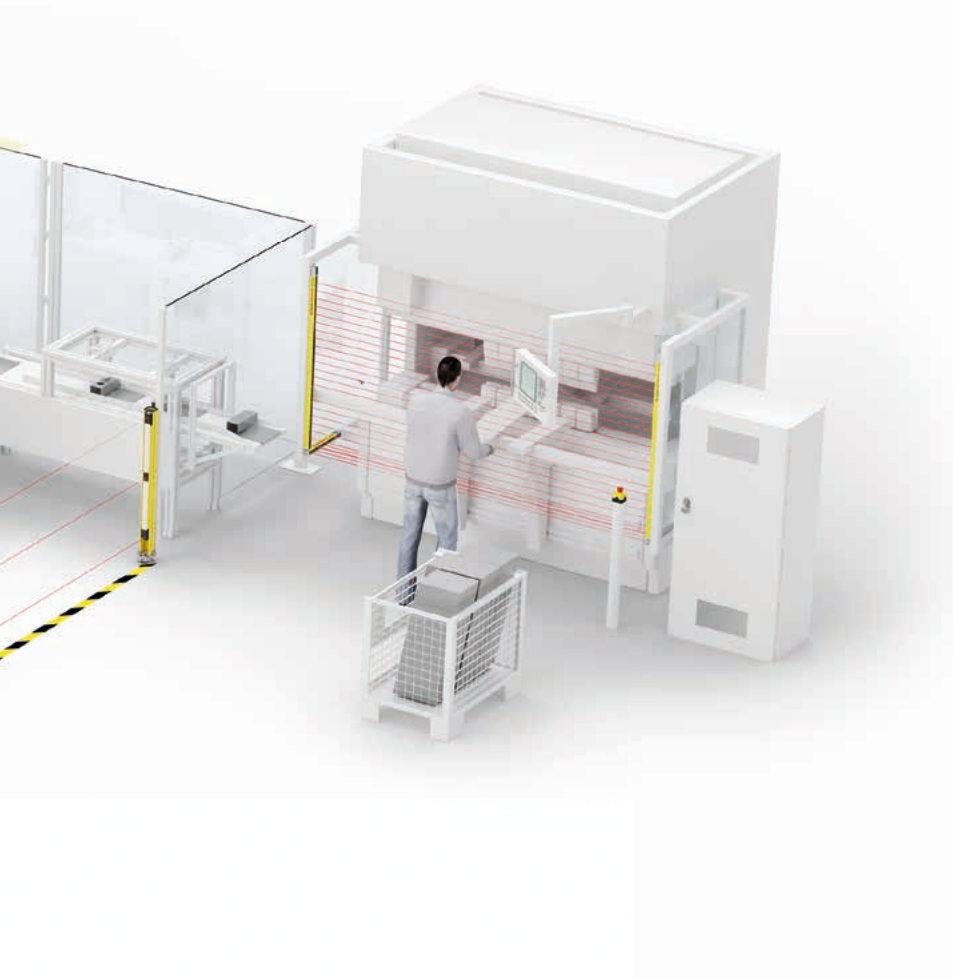

**Safety at Leuze**

Page 6–7

---

**Applications**

Page 8–17

---

**Safety products**

Page 18–41

---

**Safety services**

Page 42–43

---

**Technical data**

Page 44–51

---

**Suitable products**

Page 52–53

---

## Services

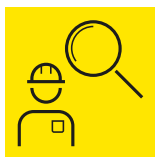

Safety services, e.g. inspections, risk analysis and validation

# Forerunner Yesterday. Today. Tomorrow.

With curiosity and determination, we – the Sensor People – have been innovators for technological milestones in industrial automation for more than 50 years. The success of our customers is what drives us. Yesterday. Today. Tomorrow.







# Safety at Leuze

The advance of automation in industry places increased demands on safety concepts. Automation continuously gives rise to new requirements aimed at ensuring the safety of persons. At the same time, the importance of smooth processes is growing constantly as a result of automation and networking.

Our driving force is the desire to guarantee you gapless safety, efficient material flow and maximum availability at all times. This is why we have bundled our expertise in work and machine safety into one portfolio so that together with you we can find optimum solutions to these challenges: Safety at Leuze.



### Experts for your application

Effective solutions begin with a comprehensive understanding of the relevant requirements. Our specialized application know-how and many years of experience in our core industries mean that we can offer a unique insight into safety-related applications. Coupled with extensive knowledge of norms and standards, we provide you with targeted answers that are able to solve even complex challenges effectively and efficiently.



### Safety from a single source

Individual requirements need flexible solutions. Our high-quality products and intelligent systems as well as competent technical services and support form the basis of our safety portfolio. Benefit from our extensive range of products. The diversity of our portfolio means that we are able to provide you with all components, from sensor to control, from a single source – all with maximum user-friendliness and all optimally matched to each other.



### Experienced safety specialists

Sustainable machine safety begins with professional planning of the safety systems. It spans the entire lifecycle of a machine. Let our experienced and certified safety experts support you with competent advice. Take advantage of over 30 years of experience in machine safety and the passionate commitment of the Sensor People.



### Innovative safety

New challenges call for innovative approaches. We are constantly developing new products and system solutions in order to meet existing requirements even better and to meet new challenges effectively. Particularly in the area of optical sensors, new technological concepts mean that we are able to set milestones again and again. From the very first photoelectric sensor to concepts such as Smart Process Gating – we actively shape the advances made in industry.

# Applications

## Guarding of points of operation

### Guarding of points of operation

**Requirement:** The point of operation at a machine or system is to be guarded by an electro-sensitive protective device. The necessary distance between the protective device and point of operation is to be as small as possible.



**Solution:** The safety light curtains of the MLC series with various resolutions ranging from 14 to 40 mm offer reliable finger and hand detection. This allows small safety distances between the safety sensor and the point of operation to be realized.

### Guarding of points of operation, with reach-under and step-behind protection

**Requirement:** Access to the point of operation is to be guarded by means of a safety light curtain. If this sensor can be reached under or stepped behind, then a further safety light curtain is required in order to detect these situations.

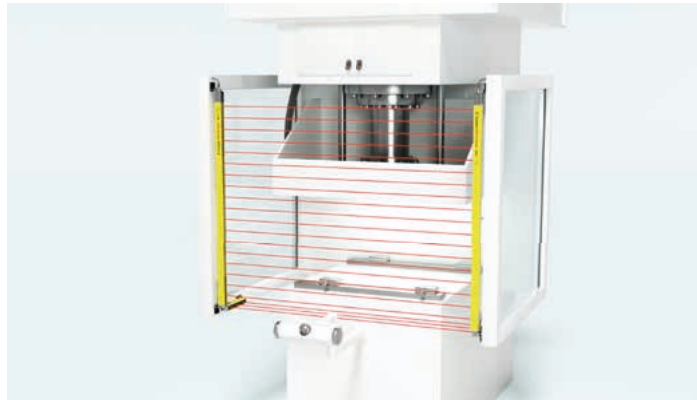

**Solution:** The cascable MLC 520 and MLC 520-S safety light curtains allow up to 3 segments to be linked together. They are integrated in the control via a common connection. This makes installation easy and cost-effective.

### Guarding of points of operation, with permissible objects in the protective field

**Requirement:** Violation of the protective field by a person must be detected by the safety sensor. Fixed or moving machine parts or work pieces inside the protective field, however, are to be permitted and must not cause a shut-down.

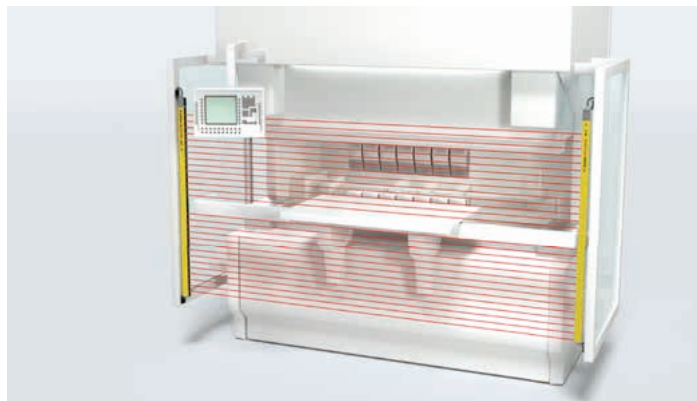

**Solution:** The MLC 530 safety light curtains have the following functions: fixed blanking, floating blanking and reduced resolution. These functions can be configured so that certain objects are permitted inside the protective field.



### Guarding of foot space on side-tracking shelves

**Requirement:** While the side-tracking shelf is moving, the foot space is to be monitored for the presence of persons. If multiple shelf rows are installed one behind the other, there must be no interference between the sensor signals of the rows.



**Solution:** The SLS 46C single light beam safety devices monitor the foot space over a length of up to 70 m. They are available as a type 4 variant and as a particularly easy-to-align type 2 variant. The use of models with red light and infrared light prevents mutual interference between the shelf rows.

### Guarding of narrow openings

**Requirement:** If it is possible to reach through a narrow opening into an area where a hazardous movement takes place, then this opening must be guarded to prevent access.



**Solution:** The SLS 46C single light beam safety devices are used at narrow openings. They are available as type 2 and type 4 variants and can be integrated easily via connector or cable.

# Access guarding

## Access guarding

**Requirement:** Access to a dangerous area at a machine or system is to be guarded. To enable simple entry and exit of material, optoelectronic safety sensors are to be used.

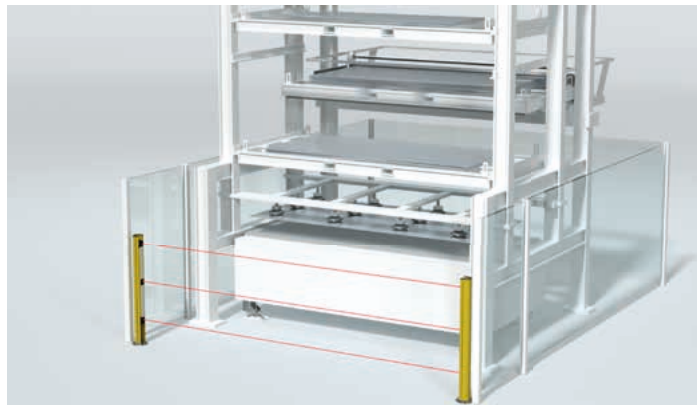

**Solution:** The MLD 300/500 multiple light beam safety devices provide cost-effective access guarding solutions. The transceiver models with an operating range of up to 8 m are especially easy to install. For wide-area guarding, transmitter/receiver models are available with a range of up to 70 m.

## Multi-sided access guarding

**Requirement:** Access to the working range is to be guarded while the machine is in operation. To enable material entry and exit, the machine must be easily accessible from multiple sides.

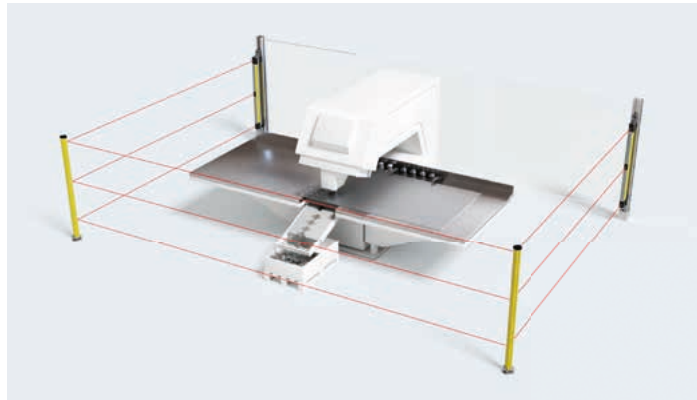

**Solution:** The MLD 300/500 multiple light beam safety devices in combination with the UMC mirror columns safeguard access to the machine on multiple sides and over lengths of up to 70 m. The integrated laser alignment aid makes installation quick and easy.

## Access guarding using sensors outside of working area

**Requirement:** Access to dangerous areas by persons and vehicles is to be monitored using safety sensor technology. The sensors must not hinder free movement within the working area.

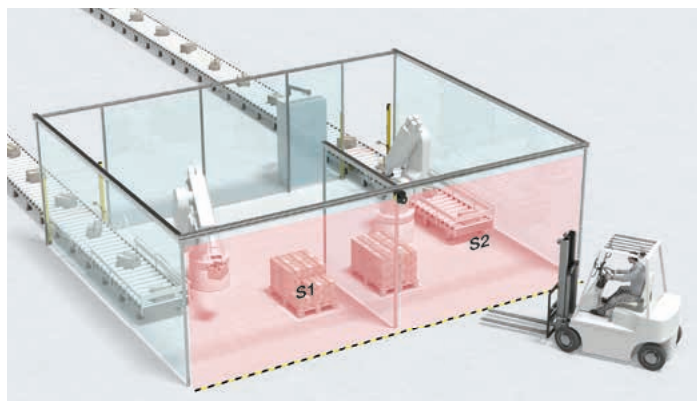

**Solution:** The RSL 400 safety laser scanner is installed above the access area and the protective field is aligned vertically. This ensures that the working area is not restricted. By using two safety functions working in parallel, one RSL 400 can monitor two stations simultaneously and independently from each other.

### Access guarding on conveyor lines, with muting function

**Requirement:** Access guarding on conveyor lines is to prevent persons from accessing the danger zone, while at the same time allowing the transported goods to pass through.

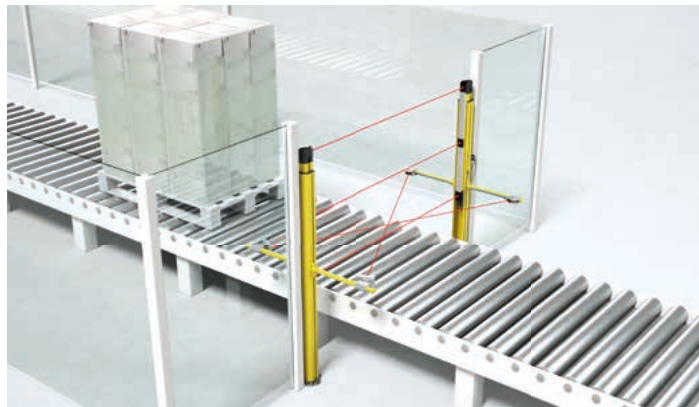

**Solution:** The muting function bridges the safety sensor in a controlled manner to allow the transported goods to pass through. This function is already integrated in the MLD 300/500 multiple light beam safety devices and the MLC 500 safety light curtains. The MSI-MD-FB muting interface and MSI 400 safety control provide an external muting control.

### Access guarding on conveyor lines, with Smart Process Gating

**Requirement:** Access guarding on conveyor lines is to prevent persons from accessing the danger zone, while at the same time allowing the transported goods to pass through.

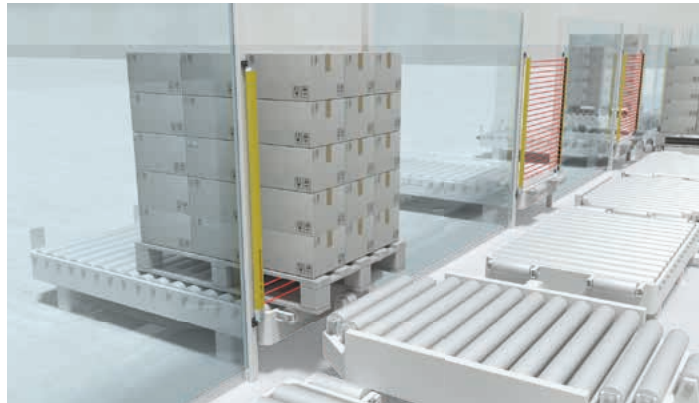

**Solution:** With Smart Process Gating, the safety sensor is bridged in combination with a control signal from the PLC. The function is integrated in the MLC 530 SPG safety light curtain. Additional muting sensors are not required and systems can be designed in a compact and space saving way.

# Area protection

## Guarding of hazardous areas

**Requirement:** The hazardous working range of the machine is to be guarded against entry by and the presence of persons. The contour of the monitored area is to be adapted to the contour of the machine.

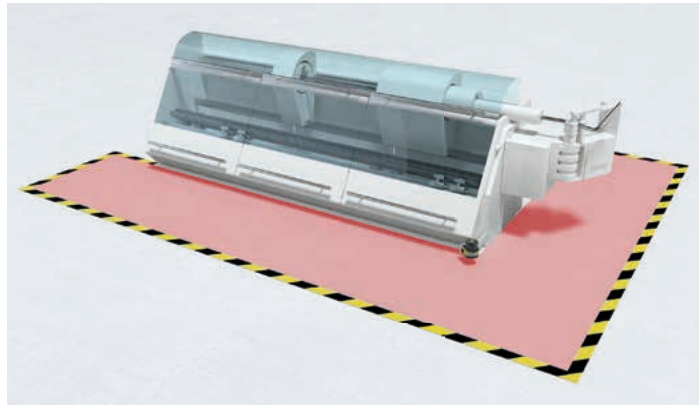

**Solution:** The RSL 400 safety laser scanners use configurable protective fields for area monitoring. Thanks to the 8.25 m operating range and 270° scanning angle, large areas can be guarded with just one device.

## Restart protection and monitoring of hidden areas

**Requirement:** To prevent danger, the process is not permitted to restart until it has been ensured that no persons are in the work area or in the hidden area.

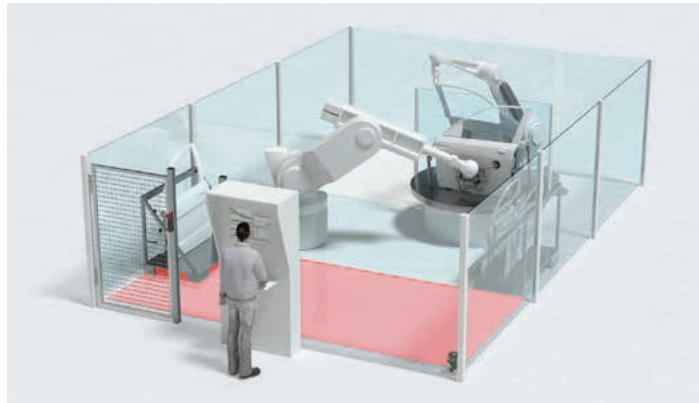

**Solution:** The RSL 400 safety laser scanner with its configurable protective field monitors the presence of persons. The LBK 3D safety radar system is used under harsh ambient conditions and also allows the presence of static objects in the monitored area.

## Guarding of hazardous areas in harsh environments

**Requirement:** The hazardous working range of the machine is to be guarded against entry by and the presence of persons. Safe operation and high availability must also be guaranteed under harsh ambient conditions – such as dirt, welding sparks, sawdust or humidity.

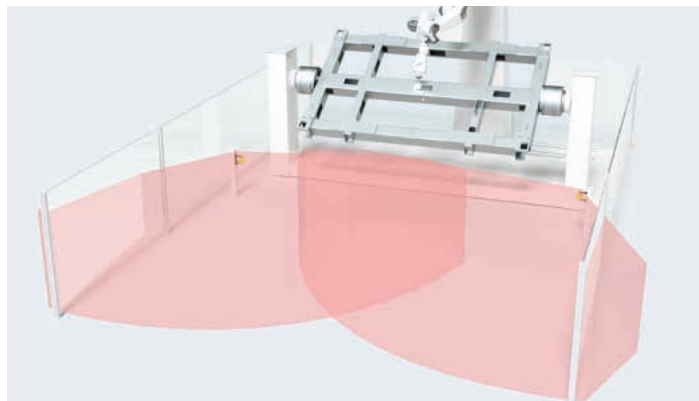

**Solution:** The LBK 3D safety radar system detects movements in the monitored area and operates reliably even under harsh ambient conditions. Furthermore, the radar technology allows the presence of static objects in the monitored area.



### Guarding and navigation of automated guided vehicles (AGVs)

**Requirement:** The transportation path of the AGV must be guarded by means of safety sensors. The protective fields are to be flexibly adapted to the movement and loading situation. If the principle of natural navigation is used, the device needs to provide measurement data for the navigation software at the same time.

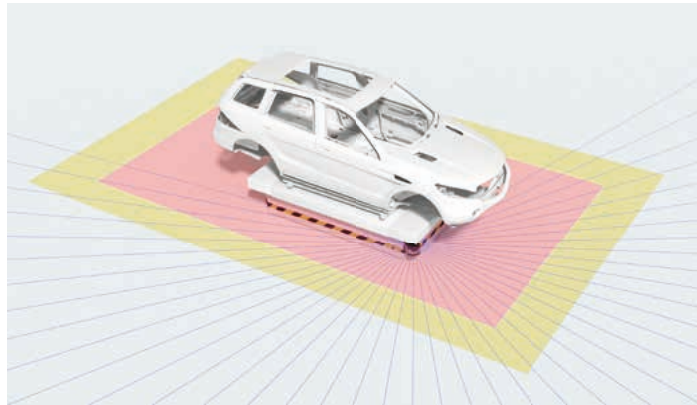

**Solution:** The RSL 400 safety laser scanner merges safety technology and high-quality measurement value output in a single device. It has a scanning range of 270° and 100 reversible field pairs. Two scanners therefore provide optimum guarding of the AGV. The measurement data has a high angular resolution of 0.1° and a low measurement error.

# Guarding of physical safety guards

## Monitoring of doors and flaps

**Requirement:** Moving protective devices such as doors and flaps protect the operator from hazards. The closed state of the protective devices must be monitored.



**Solution:** The safety switches of the S20/200 series with their robust housings and wide range of installation options can be used universally. The contactless, magnetically coded switches of the MC series are ideal for use in harsh, dirty or damp environments.

## Monitoring of doors and flaps, with high protection against manipulation

**Requirement:** The closed state of safety guards such as doors or flaps must be monitored. EN ISO 14119 stipulates that measures to protect against manipulation must also be taken into account. If this is not possible through constructive measures, the sensor must have a high level of protection against manipulation.



**Solution:** The RD 800 contactless safety transponders with RFID coding offer maximum protection against manipulation. With their OSSD outputs, they are also easy to integrate in the safety circuit.

## Monitoring of doors and flaps, with guard locking for long stopping times

**Requirement:** Areas with hazardous movements can be entered via safety doors to allow maintenance. If the movement does not stop immediately after the door is opened, the door is to be guarded by a safety switch with locking function.



**Solution:** The robust L series safety switches with guard locking keep safety doors securely locked until access is released by an electric signal. The series includes standard designs, devices with integrated operational controls as well as devices with RFID-coded actuators.

## Monitoring of doors and flaps, with guard locking for process protection

**Requirement:** When doors or flaps are opened, the process is allowed to stop only at defined positions in order to avoid scrap or maintenance work when the process starts up again. The doors or flaps are to be released only when these positions are reached.



**Solution:** The L series safety switches with guard locking keep safety doors locked until the process control sends an electric release signal.

## Safe monitoring of final positions

**Requirement:** To trigger shut-down at the end of the cutting process or for service work, it is necessary to monitor when the saw blade reaches the final position.

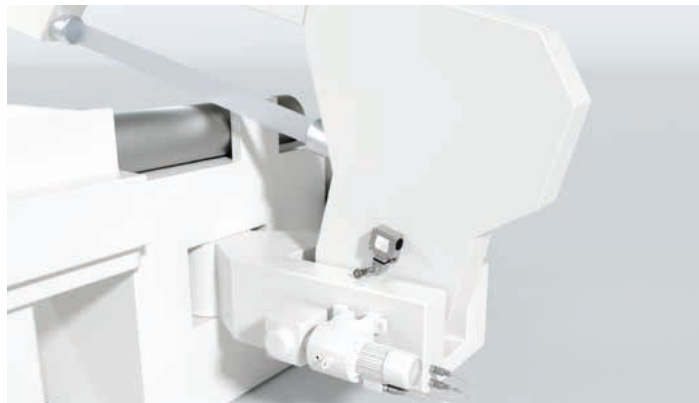

**Solution:** The S300 position switch monitors when the final position is reached. Variants with plunger and various actuators make the device suitable for universal use. With its forced normally closed contacts, the S300 can also be directly integrated into the safety circuit.

## Triggering of an emergency stop

**Requirement:** Machines and systems with dangerous movements must be equipped with an E-Stop device. This device can be actuated manually in the event of danger.

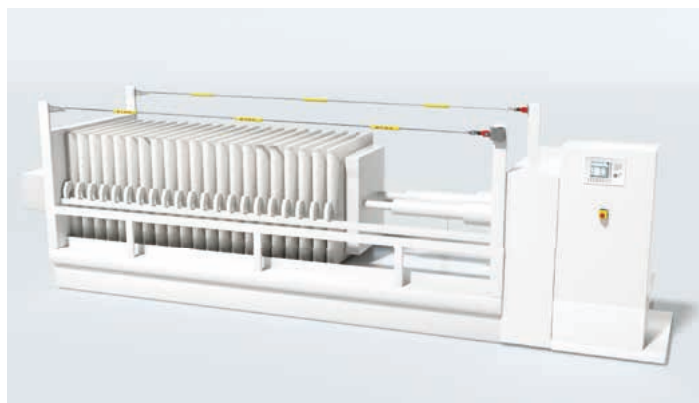

**Solution:** The ESB 200 E-Stop button is used wherever it makes sense to be able to enter a stop command at a specific location. The ERS 200 E-Stop rope switch is used for larger danger zones.

# Evaluation of safety sensors by safe control components

## Evaluation of individual safety sensors

**Requirement:** For correct execution of the safety function, safety sensors must be integrated into the machine circuit using safe control components in accordance with the requirements defined in EN ISO 13849-1.

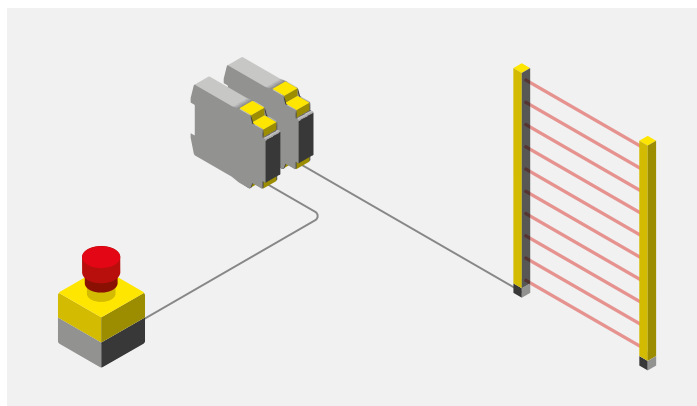

**Solution:** With the reliable MSI safety relays, individual safety sensors can be integrated quickly and easily into the safety circuit of machines and systems. Depending on the model, the relays are tailored to specific applications or can be used universally.

## Evaluation of multiple safety sensors with configurable safety functions

**Requirement:** Multiple safety sensors must be integrated into the machine or system control. Functions such as a time delay for releasing a guard locking device or signal connections are also to be configured.



**Solution:** The basic module of the MSI 400 expandable safety control already has 24 safe inputs/outputs as well as an Ethernet interface with Industrial Ethernet protocols. The safety control can be configured quickly and efficiently using the license-free configuration software MSI.designer.

## Safe motion monitoring

**Requirement:** To protect employees during maintenance and setup activities, dangerous movements must be reliably monitored. To protect machines and processes, upper and lower limit values – e.g. for speeds – must not be exceeded during operation.



**Solution:** With the MSI 400 safety control, the inputs for safe motion monitoring are already integrated in the basic module. It monitors the pulses from sensors with respect to the limits required for safe operation, e.g. for speed, angle, position and direction information.



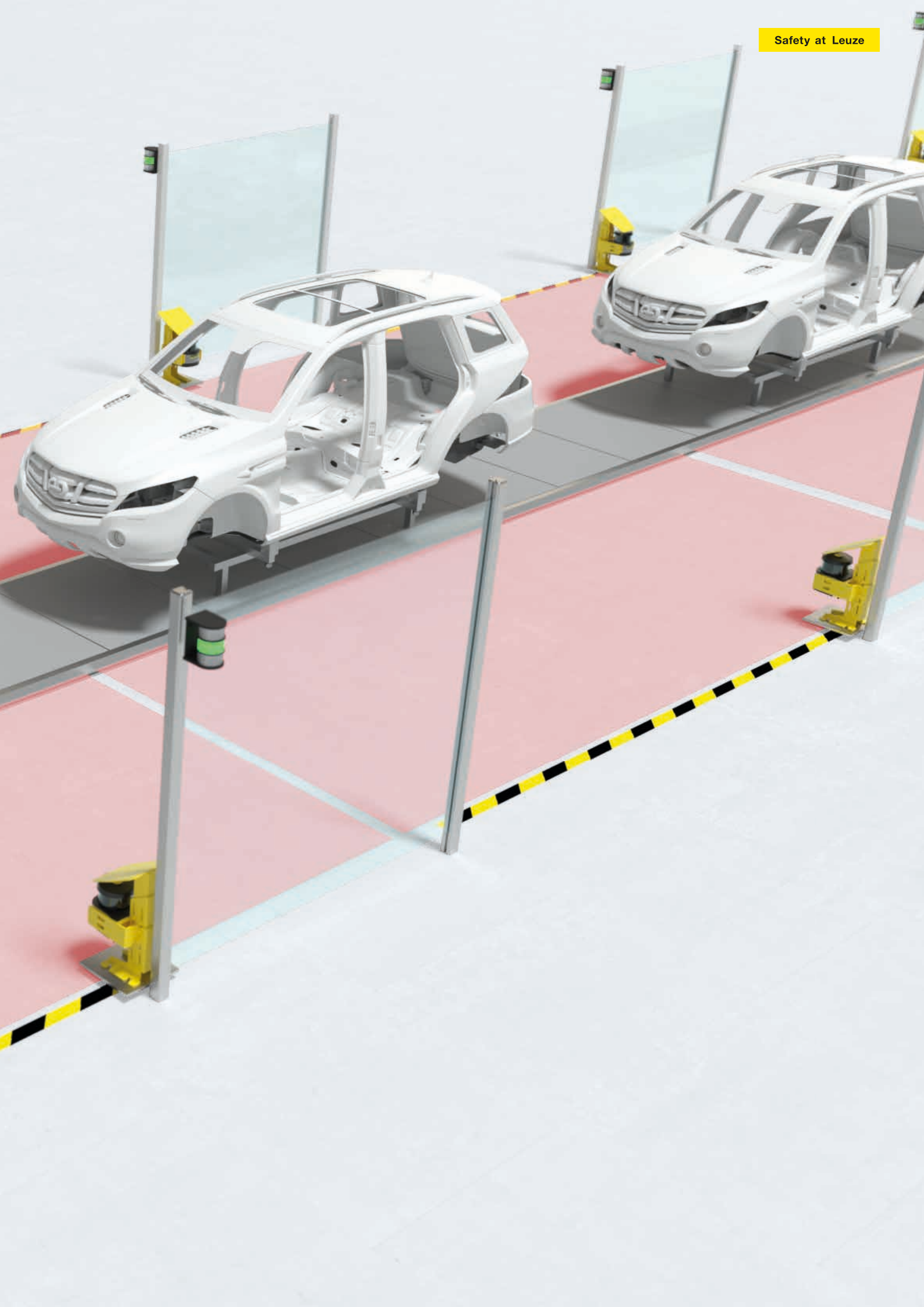

# RSL 400

## Safety laser scanner





### Areas of application

- Guarding of hazardous areas
- Guarding and navigation of AGVs
- Restart protection and monitoring of hidden areas
- Access guarding using sensors outside of working area

The innovative RSL 400 safety laser scanners are characterized by their performance, robustness and easy handling. Thanks to their high operating range of 8.25 m and a scanning angle of 270°, they can monitor even large areas. Together with two protective functions, one RSL 400 is able to perform tasks that previously required two scanners.

### Advantages for you

 <p><b>ALWAYS THE RIGHT SOLUTION</b> Operating ranges of 3 m to 8.25 m and various function variants offer tailor-made solutions for your applications</p>	 <p><b>AGV NAVIGATION</b> The high-quality measurement data output with a resolution of 0.1° delivers the data needed for reliable AGV navigation</p>	 <p><b>PROFISAFE INTEGRATION</b> Variants with PROFsafe / PROFINET interface ensure easy integration into industrial networks</p>
--	--	---

#### RSL 400

#### Features

- Operating range up to 8.25 m with a scanning angle of 270°
- Safety: Type 3, performance level PL d, SIL 2
- Up to 200 configurable fields, as field pairs or 4-field sets
- 2 parallel and independent protective functions (I/O models), 4 parallel protective functions in PROFIsafe models
- Configuration and diagnosis via Ethernet TCP/IP, USB (as of RSL 420) and Bluetooth
- High-quality measurement data output of distance value and signal strength with 0.1° angular resolution
- Selectable resolution of 30 / 40 / 50 / 60 / 70 / 150 mm
- Easy-to-use configuration software in 9 languages with context-sensitive online help

## Versatile use with a single device

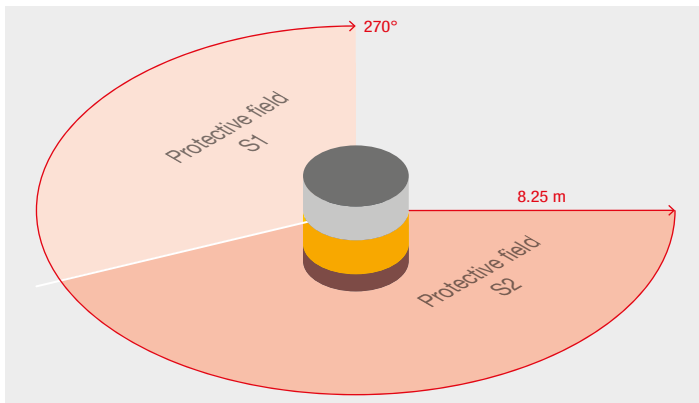

- 270° scanning angle and up to 8.25 m operating range allow even large areas to be guarded with just one device
- 2-in-1 solution: 2 independent protective functions, each with its own safety output, in a single device
- Simple integration via I/O or PROFI-safe / PROFINET interface

## Unique technology for robust operation



Thanks to the high angular resolution of 0.1°, the RSL 400 is able to filter out non-safety-relevant objects, e.g. dust and particles in the air, particularly well (approx. 3x higher sampling rate than with conventional scanners). This reduces unnecessary switching off.

To do so, the entire transmitter-receiver system of the RSL 400 rotates. This generates an extremely narrow and uniform laser spot across the entire scanning range which forms the basis for the high angular resolution and the high-quality measurement value output.

## Integrated display keeps you informed



The large characters on the integrated display are easily visible even from a distance. Various functions and messages are thereby always in view.

- The built-in electronic spirit level allows you to quickly align the device
- Thanks to the output of messages and details on protective field violations you always have an eye on the device status
- The signature (CRC checksum) can be called up without PC directly at the device

## Removable connection unit



The connection unit of the RSL 400 is removable and can be mounted separately. The scanning head thus remains protected and can simply be attached afterwards.

If servicing is required, it takes less than 30 seconds to swap out the scanner: turn two screws by 90 degrees and the scanner head can easily be changed. Without realignment, readjusting and configuration effort, as the configuration memory is integrated in the connection unit.

# MLC 300 / 500

## Safety light curtains





### Areas of application

- Guarding of points of operation
- Access guarding with short safety distances
- Access guarding on conveyor lines, with Smart Process Gating and muting functions

The extensive series of MLC safety light curtains offers both type 4 (MLC 500) and type 2 (MLC 300) safety light curtains that leave nothing to be desired in terms of resolution, protective field height and operating range. With four function classes, the robust and compact devices perform a wide variety of guarding tasks, from standard applications to controlled special safeguarding, e.g. with blanking function. Furthermore, variants with cascading, extra slim design, EX protection marking and protection class IP 69K offer tailor-made solutions for special application cases.

### Advantages for you

 <p><b>ALWAYS THE RIGHT SOLUTION</b> With protective field lengths of 150 to 3,000 mm, resolutions of 14 to 90 mm and 4 function classes, the MLC family always has the right solution</p>	 <p><b>HIGH AVAILABILITY</b> To ensure that adjacent machines operate reliably, the devices have switchable transmission channels and a reducible operating range</p>	 <p><b>SPECIAL VERSIONS</b> Variants with cascading, extra slim design, EX protection marking and protection class IP 69K offer solutions for special application cases</p>
--	--	--

### MLC 300 / MLC 500

<b>Features</b>	MLC 300: type 2, performance Level PL c, SIL 1 MLC 500: type 4, performance level PL e, SIL 3
	Resolutions of 14 mm, 20 mm, 30 mm, 40 mm, 90 mm
	Protective field lengths of 150 mm to 3,000 mm in 150 mm grid
	Operating range up to 20m
	Reliable operation of adjacent machines thanks to transmission channel switching and reducible operating range
	Blanking functions and reduced resolution to allow stationary or moving objects in the protective field
	Wide temperature range from -30 ... 55°C



## Robust housings

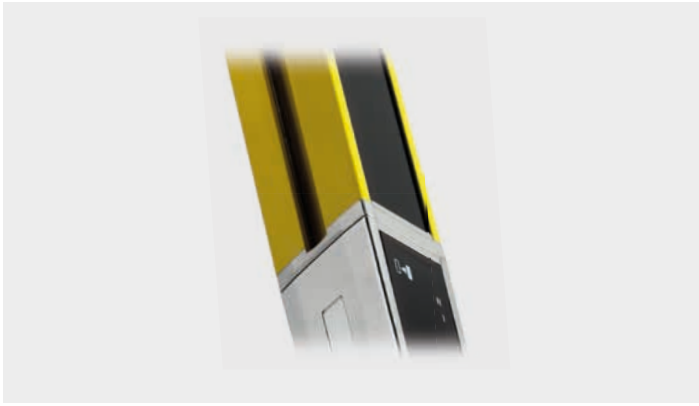

The compact devices with their robust housing design are characterized by reinforced side walls and a recessed front screen.

## Easy mounting and alignment



Different mounting brackets ensure quick and simple mounting in any installation situation. They have a low space requirement and are easy to align. Versions with additional damping elements reduce the transmission of physical shocks and vibration. They also guarantee reliable operation under demanding conditions.

## Simple and fail-safe commissioning

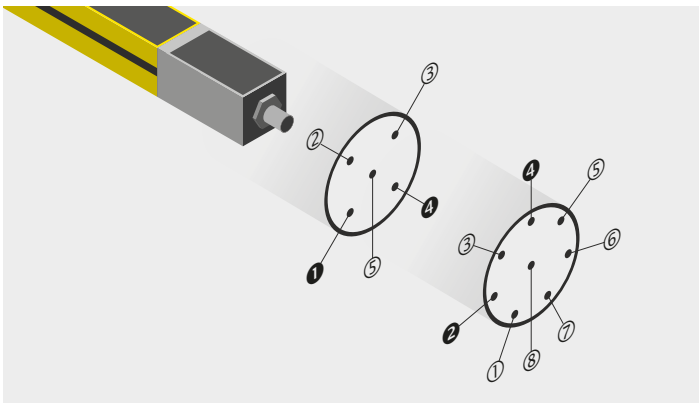

All settings on the device can be configured by means of pin assignment. This saves time and money when commissioning and ensures error-free configuration. A device can be swapped out easily by means of plug&play without reconfiguration.

## 100 meters from switch cabinet

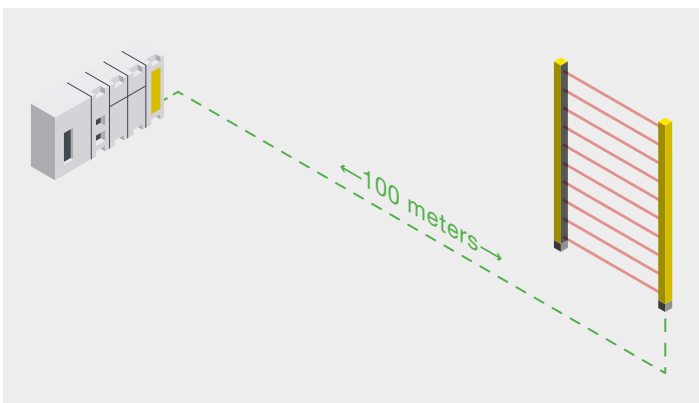

Transmitters and receivers of the MLC 300/500 family can be connected to the switch cabinet using cables measuring up to 100 meters in length. This allows flexible positioning of the machines without the need for additional components.

# MLD 300 / 500

## Multiple light beam safety devices



### Areas of application

- One-sided and multi-sided access guarding
- Access guarding on conveyor lines, with muting function

The multiple light beam safety devices of the MLD 300 (type 2) and MLD 500 (type 4) series are used for access guarding at machines and systems. The devices are available as transmitter-receiver systems for large operating ranges up to 70 m and as cost-efficient 2 and 3-beam transceiver systems for operating ranges up to 8 m.

### Advantages for you

 <p><b>ALWAYS THE RIGHT SOLUTION</b> With 2, 3 and 4-beam versions and operating ranges up to 70 m, the MLD family always offers the right solution</p>	 <p><b>MULTI-SIDED SAFEGUARDING</b> Together with the UMC mirror columns, multi-sided safeguarding is easy to implement</p>	 <p><b>INTEGRATED MUTING</b> The integrated muting functions ensure easy setup of access guarding on conveyor lines</p>
---	--	--

#### MLD 300 / MLD 500

<b>Features</b>	MLD 300: type 2, performance Level PL c, SIL 1 MLD 500: type 4, performance Level PL e, SIL 3
	2 and 3-beam transceiver systems for operating ranges up to 8 m
	2, 3 and 4-beam transmitter-receiver systems for operating ranges up to 70 m
	Integrated 2-sensor muting, time-controlled and sequence controlled Integrated 4-sensor muting, time-controlled
	Integrated laser alignment aid
	Mirror columns for multi-sided safeguarding (see page 25)
	Device status can be read off from 7-segment display at all times
	Variant with AS-i Safety interface for direct integration into AS-i bus systems
	Wide temperature range from -30 ... 55°C

## Efficient solutions for any operating range

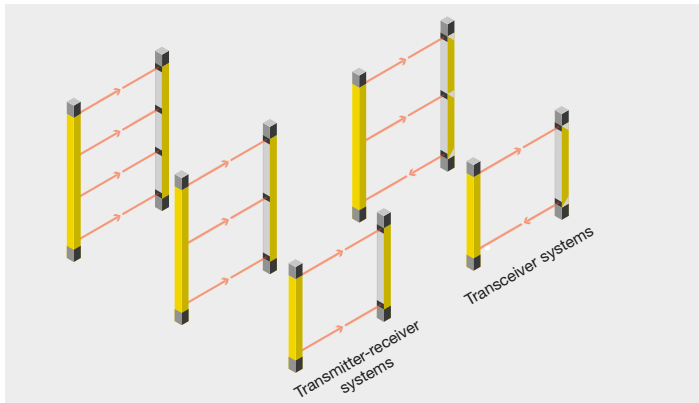

The transceiver systems consist of an active transmitter/receiver and a passive deflecting mirror without electrical connection. This allows cost-effective solutions with low installation effort. The transmitter-receiver systems consist of a separate transmitter and receiver for applications with large operating ranges up to 70 meters. Deflecting mirrors can be added for multi-sided safeguarding.

## Simple and fail-safe configuration

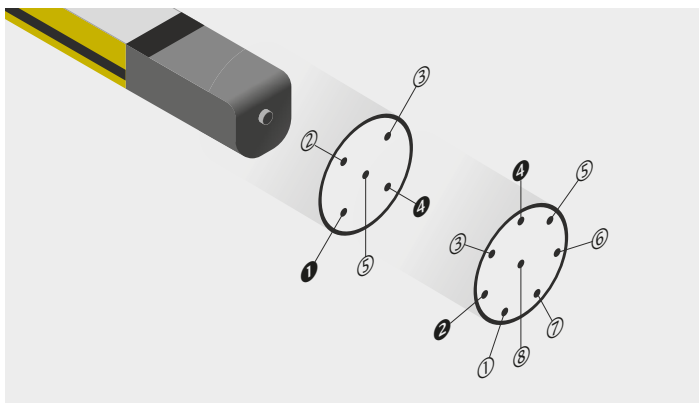

All settings on the device can be configured by means of pin assignment. This saves time and money when commissioning and ensures error-free configuration. A device can be swapped out easily by means of plug&play without reconfiguration.

## Quick and easy alignment



The practical swivel mounts and clamp brackets make the MLD easy to align. Thanks to the integrated laser alignment aid, alignment can be performed quickly and easily even over large distances and when installing multi-sided safeguarding with mirror columns.

## Clearly visible status



The integrated, multi-color indicator lights clearly show the status of the OSSD outputs at all times. Reset requests are also indicated if required.

# MLD 500, SLS 46C

## Single light beam safety devices



### Areas of application

- Guarding of foot space on side-tracking shelves
- Guarding of narrow openings
- Access guarding, e.g. with flexible beam spacing
- Collision protection, e.g. on overhead cranes

The compact SLS 46C single light beam safety devices are used together with the MSI-TR evaluation units for periodic testing. The MLD 500 single light beam safety devices in which the testing function is already integrated are used wherever there are no space restrictions or extremely large operating ranges are required.

### Advantages for you

+	<p><b>COST-EFFECTIVE</b> Up to 6 linked SLS 46C safety sensors can be evaluated by one MSI-TR safety relay</p>	+	<p><b>HIGH FLEXIBILITY</b> If mounting options are limited, arranging multiple single-beam sensors enables flexible designs of multiple-beam access guarding solutions</p>	+	<p><b>MAXIMUM OPERATING RANGE</b> For safeguarding over particularly long distances, the MLD single light beam safety devices offer operating ranges up to 100 m</p>
---	--	---	--	---	--

	SLS 46C	MLD 500
Features	Type 2 variants: operation in combination with safety evaluation devices	Type 4, performance level PL e, SIL 3 (self-evaluation)
	Type 4 variants: operation in combination with an MSI-TRM safety relay (AOPD with performance level PL e, SIL 3)	Operating range up to 100 m
	Operating range up to 70 m	Integrated 2-sensor muting, time-controlled and sequence controlled
	Red light and infrared light variants to avoid mutual interference	Integrated laser alignment aid
	Evaluation of up to 6 linked SLS 46C devices by means of one MSI-TR safety relay	Variant with AS-i Safety interface for direct integration into AS-i bus systems
	ECOLAB certification	Wide temperature range from -30 ... 55°C
	Wide temperature range from -30 ... 60°C	



# DC, UDC, UMC

DC and UDC device columns  
 UMC mirror columns  
 Pre-mounted device sets



## Areas of application

- Freestanding floor assembly of MLC safety light curtains and MLD multiple light beam safety devices
- Setup of multi-sided access guarding



The DC and UDC device columns enable easy, freestanding mounting of the MLD multiple light beam safety devices and MLC safety light curtains. The UMC mirror columns are used to set up multi-sided access guarding.

## Advantages for you

	<p><b>QUICK INSTALLATION</b>                  Special mounting brackets ensure easy installation of the safety devices in the device columns and quick alignment of the devices</p>		<p><b>MULTI-SIDED GUARDING</b>                  The mirror columns can be used for easy and reliable setup of multi-sided access guarding</p>		<p><b>HIGH AVAILABILITY</b>                  The spring elements in the foot of the columns absorb mechanical impacts and reset the columns automatically into their initial position. Alignment or repair work is unnecessary.</p>
--	---	---	---	--	---

	UDC, DC device columns	UMC mirror columns	MLD-UDC device sets
Features	Robust profile construction for stable mounting and reliable protection of the safety devices	Variants with individual mirrors for operation in combination with MLD multiple light beam safety devices	Pre-mounted sets, optimal mechanical matching
	Simple installation of the safety devices with quick height adjustment and alignment thanks to special mounting brackets	Variants with continuous mirror for operation in combination with MLC safety light curtains	Consisting of UDC device columns and MLD multiple light beam safety devices
	UDC variant: with spring elements for automatic resetting after mechanical impacts	Robust design with easy-to-adjust mirrors	Pre-aligned for fast installation
	PSC removable protective screens provide protection against device soiling and damage	Spring elements for automatic resetting after mechanical impacts	
	Simple mounting of the muting sensor sets to the external groove (see page 29)		

# MLC 530 SPG

## Devices with Smart Process Gating





### Areas of application

- Access guarding on conveyor lines, with Smart Process Gating function to bridge for material transport

The MLC 530 SPG safety light curtains with Smart Process Gating offer a space-saving alternative for access guarding on conveyor lines. With this innovative technology, process control takes place in combination with the system control. This solution requires no muting sensors and operates exceptionally reliably.

### Advantages for you

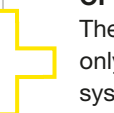
 <p><b>SPACE-SAVING</b> Smart Process Gating does not require any additional trigger sensors, thereby allowing a particularly compact system design</p>	 <p><b>RELIABLE</b> Smart Process Gating ensures the reliable passage of transported goods through the system, even with incomplete or changing loads</p>	 <p><b>OPTIMUM PROTECTION</b> The gating process starts only in combination with the system control and cannot be bypassed by the operating personnel</p>
---	--	--

### MLC 530 SPG

Features	Safety light curtain with protective field lengths of 150 mm to 3,000 mm in a 150 mm grid
	Resolutions of 30 mm, 40 mm, 90 mm
	Type 4, performance level PL e, SIL 3
	Configuration of the settings by means of pin assignment for easy commissioning
	Partial gating: the upper beams of the device are permanently active and can therefore perform a second safety function
	Blanking of stationary objects in the protective field
	Reliable operation of adjacent machines thanks to channel switching and reducible operating range
	Wide temperature range from -30 ... 55°C

## No trigger sensors required

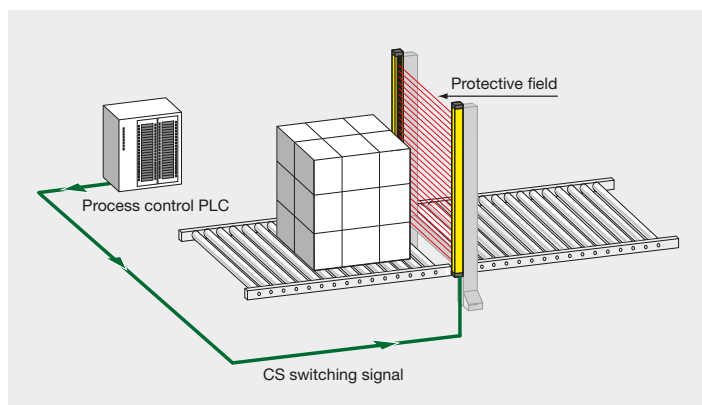

With Smart Process Gating, process control takes place in combination with the system control. A switching signal provided by the PLC and the interruption of the protective field by the transported goods are used as triggers for activating the gating function. No additional trigger sensors are required.

## Operating principle and signal response of SPG

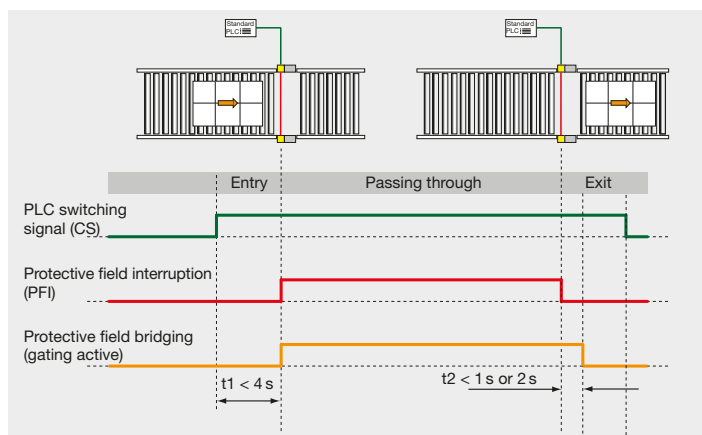

The gating function (bridging of the protective field) is activated by the correct sequence of switching signal and protective field violation and monitored by the light curtain.

The gating ends either automatically or – in the case of higher conveyor line speeds – by resetting of the switching signal.

## Two safety functions combined

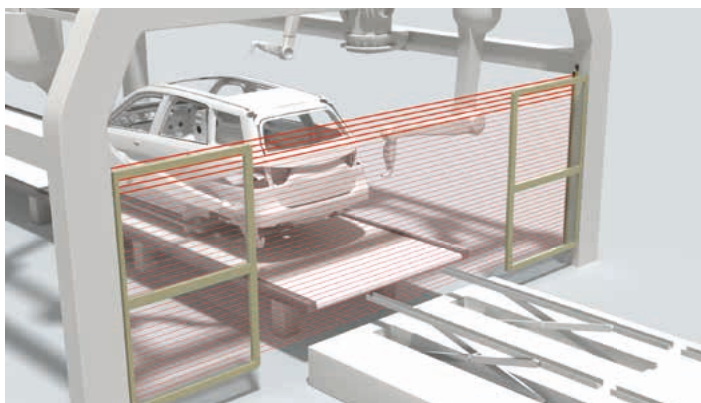

In 'Partial Gating' mode, the upper beams of the light curtain remain active during gating and can therefore be used to simultaneously monitor a second safety function.

The example shows parallel monitoring of the pendulum flaps by the safety light curtain. The safety light curtain continues to monitor the closed state of the flaps also during gating.

The otherwise usual safety switches for monitoring the flaps are no longer required.

# MLD, MLC, MSI-MD-FB, MSI 400

## Devices with muting function



### Areas of application

- Access guarding on conveyor lines, with muting function to bridge for material transport

Muting functions control and monitor the bridging function for material transport on conveyor lines. They use the signals from muting sensors to distinguish between transported goods and persons. Depending on the application, muting functions are available in various safety sensors and control components.

### Advantages for you

+	<p><b>QUICK INTEGRATION</b> Access guarding with muting function can be integrated into the safety circuit of the system control easily using OSSD outputs</p>	+	<p><b>BUILT-IN SAFETY</b> The muting functions are built into the devices and can be easily configured if required. No programming of safety functions is required.</p>	+	<p><b>ALWAYS THE RIGHT SOLUTION</b> With 2- and 4-sensors muting functions, integrated in the sensor or in the control component, our devices always offer the right solution</p>
---	--	---	---	---	---

		MLD 300, MLD 500 	MLC 500 	MSI-MD-FB 	MSI 400 
<b>Features</b>	Device type	Multiple light beam safety devices: see page 22	Safety light curtains, see page 20	Muting interface, field module: see page 41	Configurable Safety control: see page 38
	Muting function integrated in safety sensor	x	x		
	Muting function integrated in control device			x	x
<b>Muting Functions</b>	2-sensor muting, time-controlled	x	x	x	x
	2-sensor muting, sequence controlled	x		x	x
	4-sensor muting, time-controlled	x			x
	4-sensor muting, sequence controlled			x	x
	Input signal 'Muting enable'	x		x	x

## Operating principle of muting

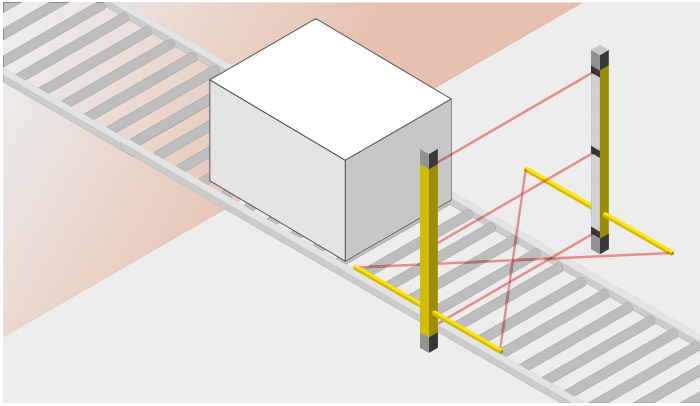

In the case of access guarding with muting function, muting sensors are used to distinguish between transported goods and persons.

The muting sensor signals are evaluated either in the safety sensor or in an external control unit.

## Typical areas of application for muting solutions



2-sensor muting, time-controlled. Universal solution for entry and exit. The muting sensors are arranged in a cross formation.



2-sensor muting, sequence controlled. Only for exit zones. For increased requirements, e.g. in terms of shape and position of the load. The muting sensors are aligned parallel to each other.



4-sensor muting, time-controlled. For entry and exit. For increased requirements, e.g. in terms of shape and position of the load. The muting sensors are aligned parallel to each other.

## Fast and easy commissioning using muting sensor sets

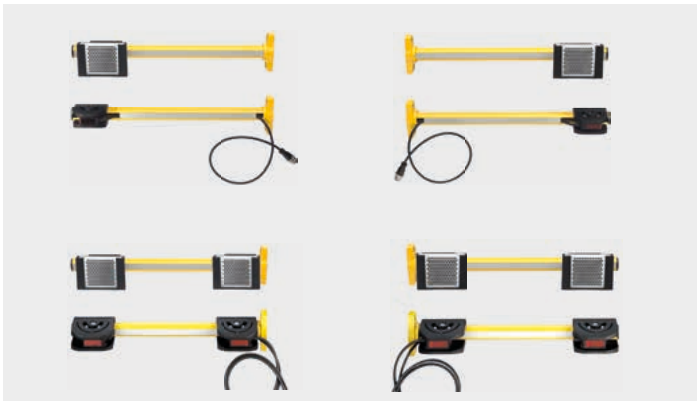

With their pre-mounted and ready-to-use setup, the Set-AC muting sensor sets ensure fast and error-free commissioning. The sets are used together with the MLD multiple light beam safety devices and the MLC safety light curtains. They are mounted easily to the side of the UDC device columns or directly to the MLD and MLC devices.

## Fully preconfigured



The MLDSET safety sensor sets offer complete solutions for access guarding with muting function. Thanks to the ready-to-use design with pluggable connections, the pre-mounted sets guarantee efficient setup and fast commissioning. A wide selection of turnkey variants optimized to the different muting tasks is available.



# LBK

## Safety radar system





### Areas of application

- Guarding of hazardous areas in harsh environments
- Restart protection
- Monitoring of hidden areas

The world's first safe 3D radar system, LBK from Inxpect S.p.A., was developed for the monitoring of hazardous areas in harsh industrial environments. It detects the bodies of persons and in doing so monitors the protected area for access and presence. The system consists of sensors and controller, combining up to 6 sensors in one application.

### Advantages for you

 <p><b>ROBUST</b> The radar technology also functions reliably under harsh ambient conditions, e.g. with dirt, dust, smoke and light</p>	 <p><b>FLEXIBLY ADAPTABLE</b> The shape of the protected areas can be flexibly adapted to the respective application. It is defined by the number and position of the sensors as well as the adjustable operating ranges and opening angles.</p>	 <p><b>SETUP SERVICE</b> On request, our certified experts will plan, configure and set up your application</p>
--	---	---

### LBK

<b>Features</b>	Safe 3D radar system with FMCW modulation for detecting movements, frequency range 24 GHz
	Category 2, performance level PL d, SIL 2
	Operating range up to 4 m, angle of radiation (horizontal/vertical): narrow 50° / 15°, wide 110° / 30°
	Configuration of safety area and warning area
	Up to 6 sensors can be combined in one application
	Deactivation of individual sensors and groups of sensors
	Temperature range -40°C ... +60°C, protection class IP 67
	Easy-to-use configuration software

## Reliable operation under demanding environmental conditions



The radar principle is resistant to environmental influences such as dirt, dust, sawdust, smoke, oil, humidity and light.

This guarantees reliable operation of the machine even under demanding environmental conditions and avoids unnecessary shutdown.

## Function of radar sensors

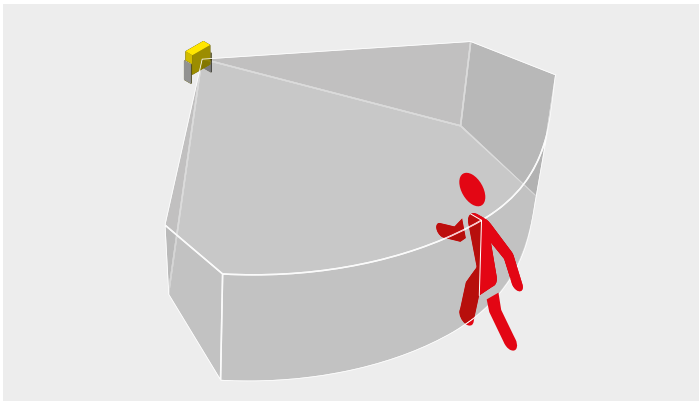

The LBK safety radar sensors detect movements and are used for guarding hazardous areas. They monitor the protected area for access by and the presence of persons. Even persons who are standing still are not really “static”, and are therefore detected reliably by the sensor.

Thanks to the 3D radar principle, areas on steps or pedestals and behind non-metallic shadowing can also be monitored.

## Static objects permitted in protected area

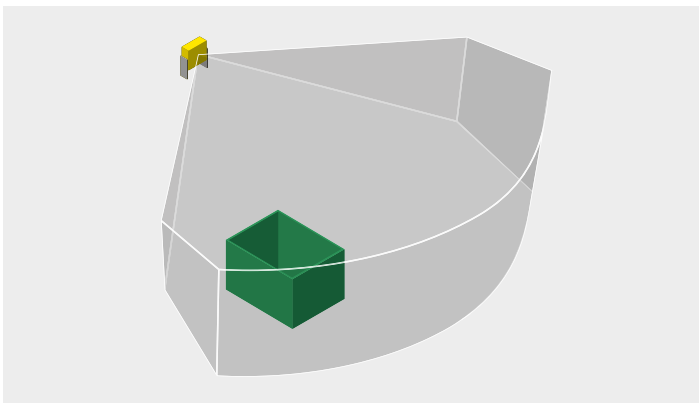

The radar technology reacts sensitively to movements. However, static objects in the monitored area do not cause the safety signal to switch off.

Static objects such as pallets, material containers and tool trays are therefore allowed to be placed in the protected area.

## Flexible system set-up

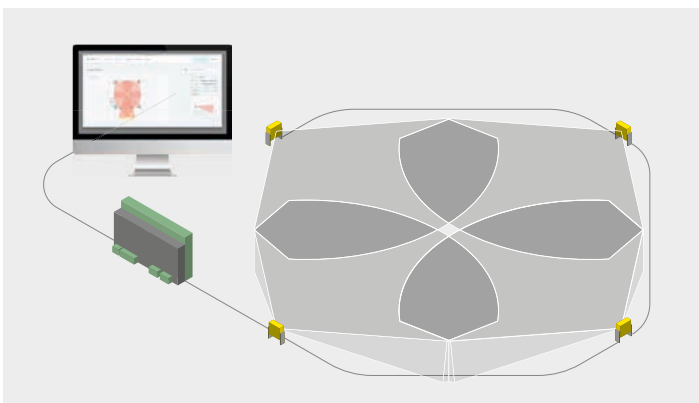

To guard large areas, up to 6 sensors can be combined in one application using a control unit. The system parameters are set using the easy-to-use configuration software.

# S20 / S200, S300, S400

Safety switches  
 Safety position switches  
 Safety hinge switches



## Areas of application

- Monitoring of doors and flaps
- Safe monitoring of final positions

The safety switches of the S20/200 series with their robust housings and wide range of installation options can be used universally. The S300 position switches monitor the reaching of final positions. Variants with plunger and various actuators enable optimum adaptation to the installation situation. The S400 safety hinge switches unite the safety switch and door hinge functions in one component.

## Advantages for you

	<p><b>SAFELY INTEGRATED</b>                  All safety switches can be easily integrated into a safety circuit by means of positive opening contacts</p>		<p><b>COST-EFFECTIVE</b>                  The S20 / S200 safety switches provide a cost-effective solution for monitoring doors and flaps</p>		<p><b>TAMPER-PROOF</b>                  Thanks to the switching function encapsulated in the devices, the S400 safety hinge switches offer a high level of protection against manipulation</p>
--	---	---	---	--	--

	S20 / S200	S300	S400
<b>Features</b>	Type 2 interlock device without guard interlocking in acc. with EN ISO 14119	Type 1 interlock device without guard interlocking in acc. with EN ISO 14119	Type 1 interlock device without guard interlocking in acc. with EN ISO 14119
	Technopolymer housing (S20), metal housing (S200), both with protection class IP 67	Technopolymer and metal housing, protection class IP 67	Metal housing, protection class IP 67 / IP 69K
	Actuator with mechanical tongue and low coding level in acc. with EN ISO 14119	Actuation by uncoded cam in acc. with EN ISO 14119	Actuation by encapsulated position switch inside hinge, high level of protection against manipulation
	Positive-opening contacts for integration in a safety circuit	Positive-opening contacts for integration in a safety circuit	Positive-opening contacts for integration in a safety circuit
	Easy mounting with standard construction	Universal use with individually set actuator approach directions and angles in 10° grid	Hidden cable routing thanks to connection on rear side
	Universal use with 5 actuator approach directions	Switching direction selectable	180° maximum opening angle of the protective device
	Up to 8 different actuators	Variants with plunger actuator and various roll actuators	Adjustable switching point
	High-quality silver contacts for long life expectancy	Extremely durable and robust	Model S410 with wide fork dimension for special materials, e.g., glass
		Optional additional hinges (without contacts)	

# MC 300, RD 800

Safety proximity sensors,  
magnetically and RFID coded

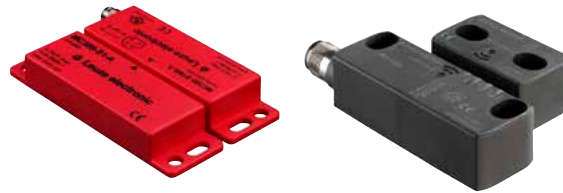



## Areas of application

- Monitoring of doors and flaps
- Manipulation protection integrated in sensor is necessary

Owing to their enclosed design and contact-free operating principle, the MC 300 magnetically coded proximity sensors and the RD 800 RFID-coded proximity sensors are ideal for use in harsh, dirty and damp environments.

## Advantages for you

 <p><b>LONG LIFE EXPECTANCY</b> Safety proximity sensors operate free from wear and have a long life expectancy, even with frequent operating cycles</p>	 <p><b>TAMPER-PROOF</b> The RFID-coded actuators of the RD 800 safety transponder offer optimum protection against manipulation. Special installation measures are not necessary.</p>	 <p><b>MAXIMUM SAFETY</b> Even with just one device, the RD 800 safety transponders achieve performance level PL e in accordance with EN ISO 13849-1</p>
--	--	---

	MC 300	RD 800
<b>Features</b>	Type 4 interlock device, contactless actuation in acc. with EN ISO 14119	Type 4 interlock device, contactless actuation in acc. with EN ISO 14119
	High-strength plastic housing, protection class IP 67	High-strength plastic housing, protection class IP 67 / IP 69K
	Actuator with low coding level in acc. with EN ISO 14119	Actuator with low or high coding level in acc. with EN ISO 14119
	Contact type 2 NC or 1 NC + 1 NO	OSSD safety outputs, series connection possible
	Models with additional signalling contact and status LED	Performance level PL e, category 4 in acc. with EN ISO 13849-1 with a single device
	Connection via cable and M8 / M12 connector	Status display on the sensor and signalling contact
		Models with programming input for teaching-in actuators
	Connection via cable or M12 connector	

# L100 / 200, L250, L300

## Safety switches with guard locking





### Areas of application

- Monitoring of doors and flaps, with guard locking for long stopping times
- Monitoring of doors and flaps, with guard locking for process protection

Safety switches with guard locking keep doors locked and thus prevent unauthorized entry or access, thereby protecting persons and processes. The L series features a wide range of variants for different application cases, from devices with mechanical actuators to devices with an RFID-coded actuator for maximum manipulation protection as well as integrated command buttons. With their robust design, all devices are designed for rough industrial applications.

### Advantages for you

	<p><b>SECURE LOCKING</b> With a locking force of up to 9,750 N, doors remain securely locked even under extreme loads</p>		<p><b>TAMPER-PROOF</b> The RFID-coded actuators offer optimum protection against manipulation. Special installation measures are not necessary.</p>		<p><b>FULLY GUARDED</b> Integrated command buttons and emergency stop as well as the matching door handle enable complete safety functions to be easily implemented at safety doors</p>
--	---	---	---	--	---

	L100 / L200	L250	L300
<b>Features</b>	Type 2 interlock device with guard interlocking in acc. with EN ISO 14119	Type 4 interlock device with guard interlocking in acc. with EN ISO 14119	Type 4 interlock device with guard interlocking in acc. with EN ISO 14119
	Mechanical tongue with low coding, 6 different actuators	RFID-coded actuator for maximum protection against manipulation	RFID-coded actuator for maximum protection against manipulation
	Positive-opening contacts for integration in the safety circuit	OSSD safety-related switching outputs	OSSD safety-related switching outputs
	For safety applications up to performance level PL e, SIL 3	Performance Level PL e, SIL 3 with a single device	Performance Level PL e, SIL 3 with a single device
	Locking force 1,100 N (L100) Locking force 2,800 N (L200)	Locking force 2,100 N for universal use on small to medium-sized safety doors	Locking force 9,750 N for use even under extreme loads
	Technopolymer housing with protection class IP 67 (L100) Metal housing with protection class IP 67 (L200)	Compact and easy-to-clean technopolymer housing with protection class IP 67 / IP 69K	Robust metal housing with protection class IP 67 / IP 69K for use in harsh environments
	Escape unlocking function through ergonomically optimized panic button (L200)	Escape unlocking function through ergonomically optimized panic button	Escape unlocking function through ergonomically optimized panic button
	LED display unit for on-site diagnosis (L200)	LED display unit for on-site diagnosis	LED display unit for on-site diagnosis
		Variable installation thanks to 3-sided mounting and flexible orientation of connections	Variable installation thanks to flexible alignment of device head and escape unlocking
			Integrated command buttons and emergency stop button for easy implementation of complete safety functions on the safety doors



### Complete guarding with just one device

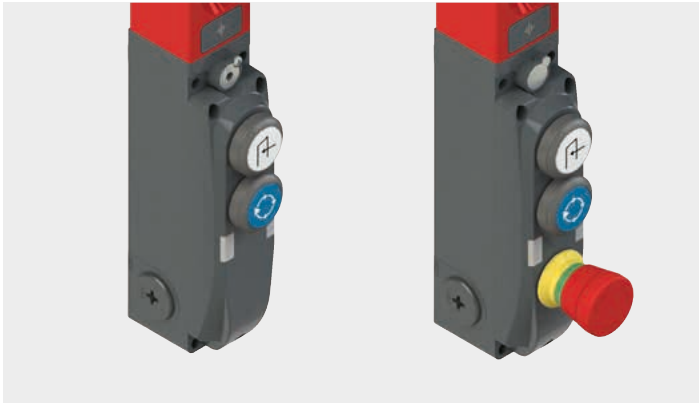

The optional command buttons of the L300 safety locking device simplify the setup of safety functions at safety doors. With the integrated buttons for request, reset and emergency stop, the compact device provides a complete solution for the safety system installation at an access door. This simplifies wiring and saves space.

### Escape unlocking with panic button

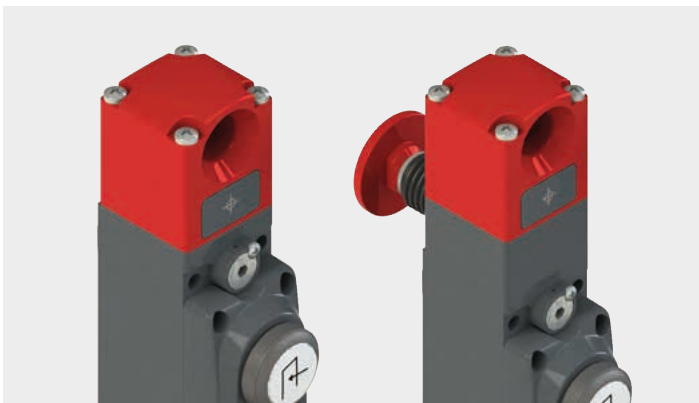

The optional escape unlocking function (panic button) enables the actuator to be unlocked immediately and the door to be opened from inside the danger zone. The ergonomically optimized button allows the operator to then leave the danger zone if he is inadvertently locked inside. The device also functions if the power supply fails.

### Designed for reliable operation

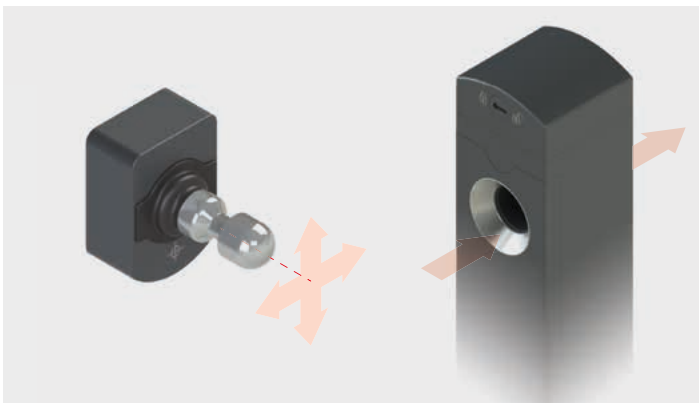

The joint at the actuator and the large, chamfered opening on the device minimize the risk of collision between the sensor and actuator and prevents damage even with imprecisely closing doors. The unobstructed opening allows accumulated dirt to be simply pushed out on the rear side. The special design thus guarantees maximum reliability and availability.

### Door handle with lockout-tagout

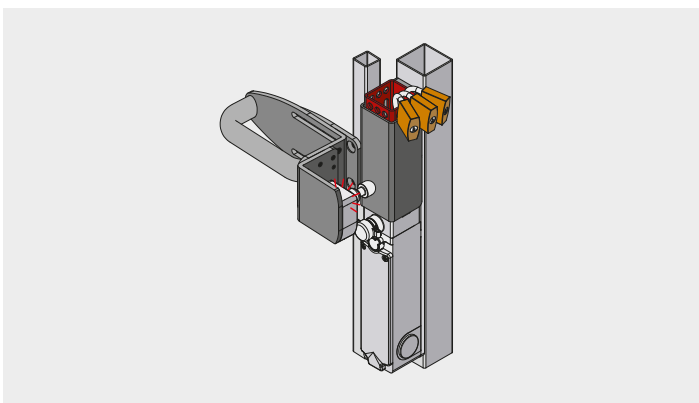

The adjustable door handle, which can be mounted on the right or left, ensures quick and easy installation of the L300 safety locking device on swing doors and sliding gates. The extremely robust metal construction supports the benefits of door centering by means of the joint on the actuator. The lockout-tagout device prevents operating personnel from being locked inside the danger zone by using individual padlocks. For this purpose, the safety mechanism is pushed downward and the lock inserted.

# ESB 200, ERS 200

E-Stop buttons  
E-Stop rope switches



### Areas of application

– Triggering of an emergency stop



The ESB 200 E-Stop button is used wherever it makes sense to be able to enter a stop command at a specific location. The ERS 200 E-Stop rope switch is used for larger danger zones.

### Advantages for you

	<p><b>UNIVERSAL USE</b> The ESB 200 E-Stop button in the surface-mounted version with screw terminals or M12 connection can be used universally and is easy to install</p>		<p><b>ALWAYS THE RIGHT SOLUTION</b> The ERS 200 E-Stop rope switches are available with left-pull actuation, right-pull actuation and actuation along the longitudinal axis and thus can always be integrated at the optimum position in the machine</p>
--	--	---	--

ESB 200 E-Stop button

ERS 200 E-Stop rope switch

Features	ESB 200 E-Stop button	ERS 200 E-Stop rope switch
	Surface-mounted variant for universal use	Clicks in on both sides with friction-locking contacts
	2 safety circuits, 1 signal circuit	Easy alignment with switching point indicator
	Optionally with key release	Easy integration with three cable approach directions
	Connection with screw terminals or M12 connector	Compact metal housing, protection class IP 67
	Ergonomically optimized	Reset button with status display
	Protection class IP 67 and IP 69K	Temperature compensation for longer rope lengths

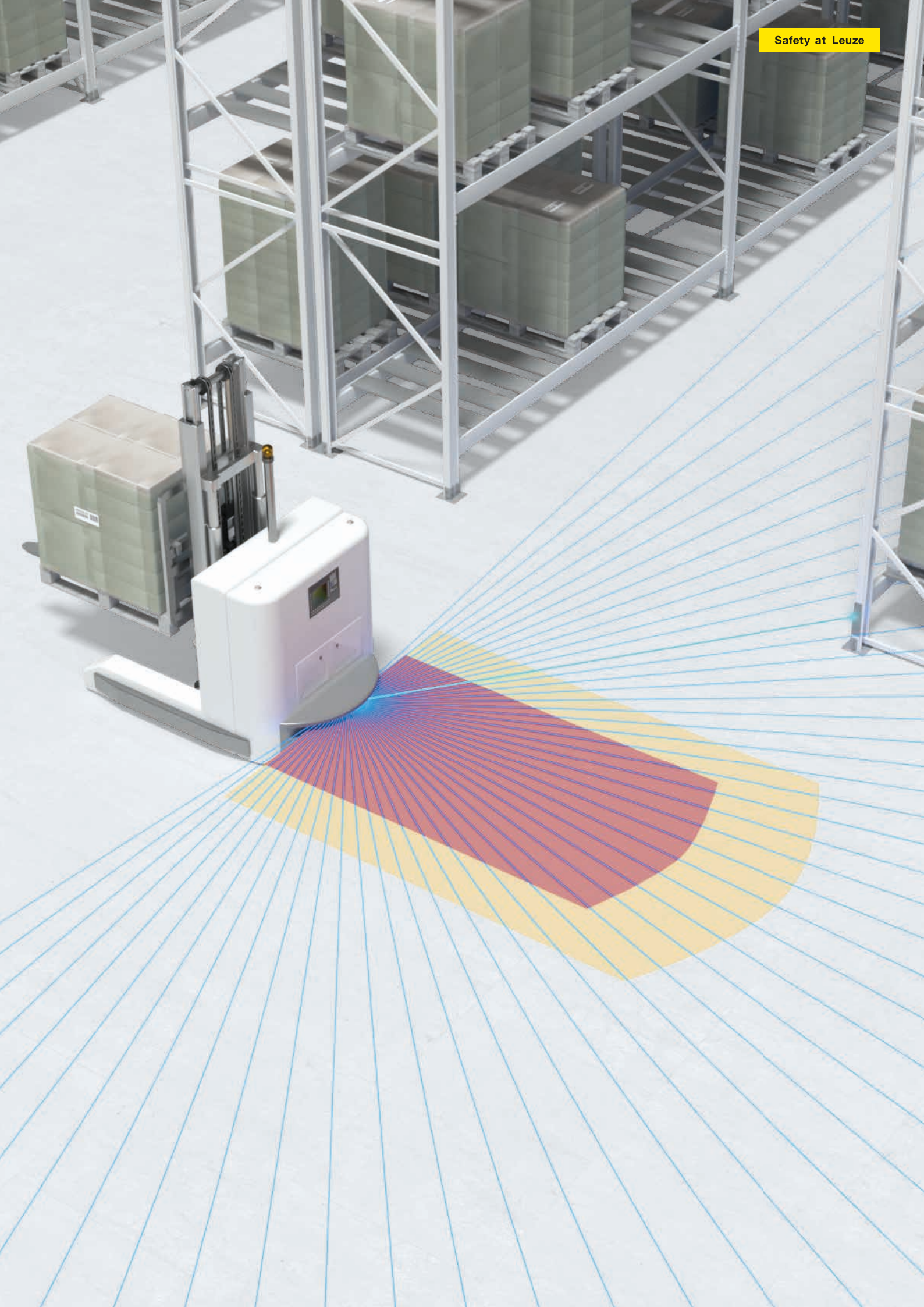



# MSI 400

## Configurable safety controls



### Areas of application

- Evaluation of multiple safety sensors
- Evaluation with configurable safety functions
- Safe motion monitoring

The basic modules of the MSI 400 safety controls already have 24 safe inputs/outputs and an Ethernet interface with Industrial Ethernet protocols. They are modularly expandable and are equipped with special function modules for safe motion monitoring and for press control. Configuration and project planning works fast and efficiently using the license-free configuration software MSI.designer. It is easy to use and has numerous comfort functions.

### Advantages for you

+	<p><b>SPACE-SAVING</b> 24 safe I/Os and Industrial Ethernet protocols are integrated on a width of just 45 mm. This reduces the space required in the switch cabinet and simplifies ordering because there is only one part number.</p>	+	<p><b>SAFE MOTION MONITORING</b> The functions for safe motion monitoring are already integrated in the basic module. Add-on modules are not required.</p>	+	<p><b>MAXIMUM SWITCHING POWER</b> Available at each output of the system is 4A of wear-free switching power. This allows e.g. valves to be actuated directly and makes additional relays unnecessary.</p>
---	---	---	--	---	---

	MSI 400	MSI.designer
Features	Basic modules with a width of 45 mm and 24 safe inputs/outputs	More than 40 certified function blocks
	Expandable to 116 safe inputs and 56 safe outputs	Up to 300 function blocks per project
	Optical function indication via LEDs for each input/output of the system	Freely configurable views spread over multiple screens
	Gateways for PROFINET, Ethernet/IP and Modbus are integrated in the basic module. Gateway modules are available for EtherCAT, PROFIBUS and CANopen.	Connection of sensors / actuators and function blocks directly in the logic editor with automatic assignment of the inputs and outputs
	Safe motion monitoring in the basic module	Simulation function and integrated logic analyzer for checking the configured functions
	Safety functions for press control	Configurable report for easy and professional documentation
	4 A wear-free switching power	Password protection of projects and function blocks
	All devices either with screw terminals or spring-cage terminals	Online diagnosis with system logbook and remote maintenance function

## Modularly expandable



The different basic modules of the MSI 400 family offer an application oriented start and feature 24 safe inputs/outputs already. With the I/O extension modules they allow flexible expansion to up to 116 safe inputs and 56 safe outputs – ideal for safeguarding larger machines and systems.

## Integrated gateways

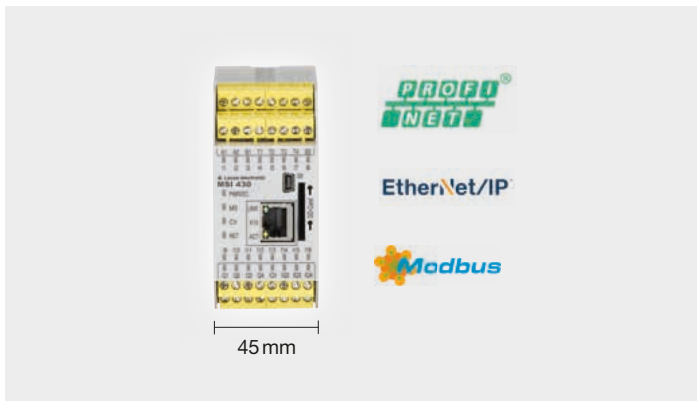

The MSI 400 safety controls can be integrated easily into industrial networks. With a width of just 45 mm, Ethernet interface and Industrial Ethernet protocols are already integrated. Gateway modules are used for integration into other fieldbuses such as EtherCAT, PROFIBUS and CANopen.

## Removable program memory



The removable program memory in SD card format, which can be accessed from the front side, provides plenty of space for application programs and comments. This simplifies project handling and reduces the time required for commissioning, duplication and servicing. The cover fastened to the control protects the memory from unintended removal.

## Graphic – intuitive – easy

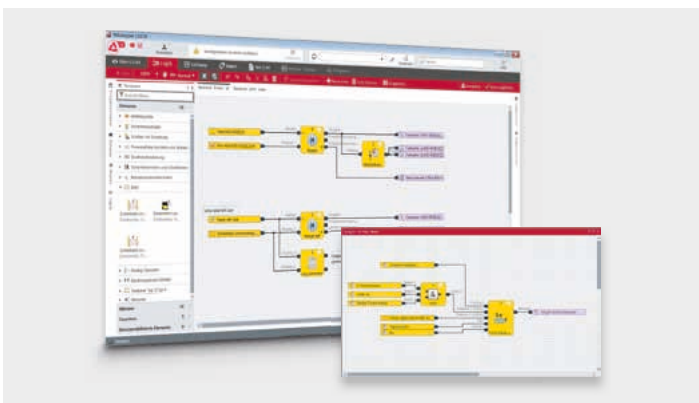

With the configuration tool MSI.designer you can create projects easily and efficiently. The license-free software supports you during the creation, testing and documentation of projects.

- Extensive library of certified function blocks
- Fast program creation through the direct use of sensors and actuators in the logic editor
- Simulation and logic analysis for testing the safety function right from a PC
- Force mode for detailed function tests
- Configurable report for professional and well-organized documentation



# MSI-SR

## Safety relays Contact extensions





### Areas of application

- Evaluation of individual safety sensors
- Contact multiplication for safety relays and safety controls
- Output extension for OSSDs

With the MSI safety relays, individual safety sensors can be integrated quickly and easily into the safety circuit of machines and systems. The applications range from the monitoring of simple components, such as E-Stops or safety switches, to the integration of optoelectronic sensors and the implementation of time-delayed functions. The contact extensions are used both as an output extension for OSSDs and for contact multiplication for evaluation units and safety controls.

### Advantages for you

	<p><b>ALWAYS THE RIGHT SOLUTION</b> Specific as well as universal evaluation units are available for safety sensors, switches and command devices</p>		<p><b>FLEXIBLE CONNECTION</b> All devices are available either with screw terminals or spring-cage terminals. This allows you to focus on reduced device costs or simplified installation.</p>		<p><b>PLUGGABLE TERMINALS</b> All MSI devices have pluggable terminals. This means easier access during installation and allows devices to be swapped out quickly during servicing.</p>
--	---	---	--	--	---

	Evaluation units	Contact extensions
<b>Features</b>	Two or three normally open contacts (NO) and one normally closed contact (NC)	Contact multiplication for evaluation units and safety controls
	Automatic and manual restart	Extension to up to 5 normally open contacts (NO)
	Contactor monitoring (EDM)	Simplified variants for output extension of OSSDs
	Switching current up to 8 A	Switching current up to 6 A
	Parallel evaluation of two safety devices with one relay (MSI-SR5 model)	Model with two parallel output extensions 2x (2 NO / 1 NC) in one device (MSI-SR-CM42R)
	Models with adjustable time delay up to 3 seconds or up to 30 seconds	
	Models with periodic testing for type 2 and type 4 safety sensors	

# MSI-MD-FB

## Muting interface





### Areas of application

- Access guarding on conveyor lines with muting function

The MSI-MD-FB muting interface provides extensive muting functions in combination with the standard variants of the MLC safety light curtains and MLD multiple light beam safety devices. As a field module, it is installed close to the safety device and combines all the necessary connections for sensors, muting indicators and reset buttons. Three muting operating modes and other detailed functions ensure optimal adaptation to the application. If low safety distances are necessary, the MSI-MD-FB together with the MLC safety light curtains offer a flexible muting solution.

### Advantages for you

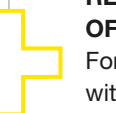
 <p><b>FLEXIBLE</b> The muting interface has configurable muting functions to allow flexible adaptation to the application</p>	 <p><b>EASY CONFIGURATION</b> The interface can be configured easily and without PC using the concealed DIP switches</p> 	 <p><b>REDUCED RANGE OF TYPES</b> For applications with and without muting: By using the muting interface, the same safety sensor variant can be used in all applications</p>
--	--	--

#### MSI-MD-FB

#### Features

- Muting interface for muting applications in combination with standard variants of the MLC safety light curtains and MLD multiple light beam safety devices
- Muting operating modes: 2-sensor time-controlled, 2- and 4-sensor sequence-controlleds
- 'Muting-enable' input signal
- Selectable muting timeout: 20 sec., 2 min., 10 min., 100 hrs.
- M12 connector, 5 and 8-pin
- Wide temperature range from -30 ... 60°C, protection class IP 67

# Machine Safety Services

Sustainable machine safety begins with professional planning of the safety systems and spans the entire lifecycle of a machine. Our teams of experienced and certified experts offer the appropriate support here.

## Stages of a machine life cycle

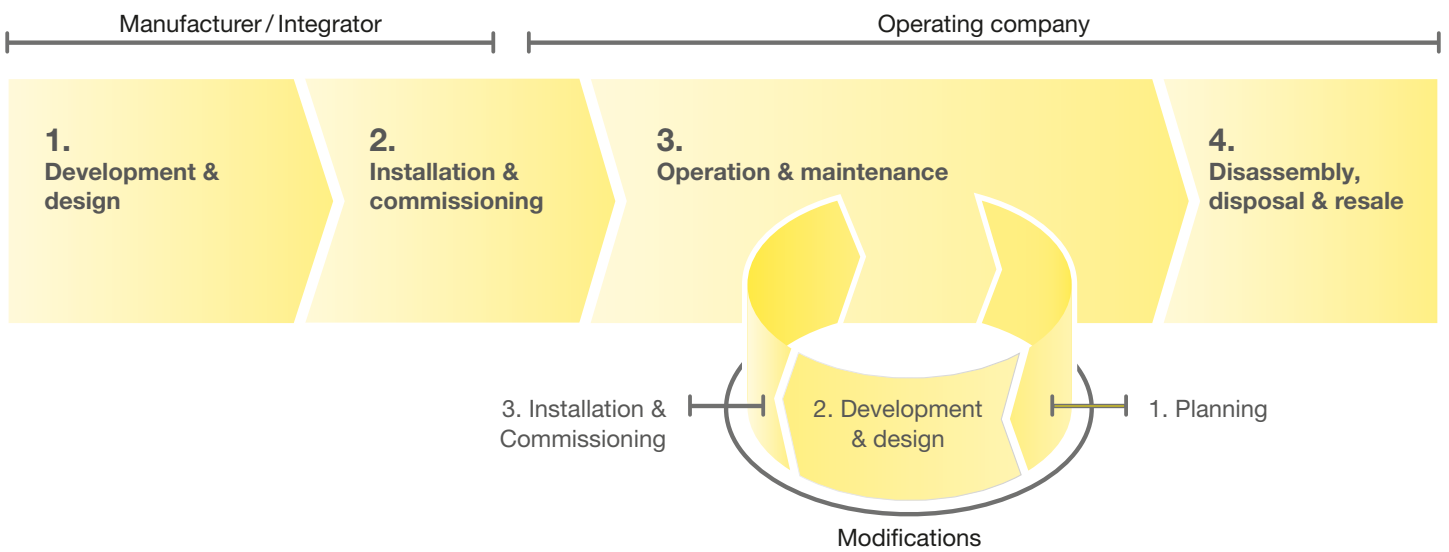

When designing and constructing machines, we create the safety-related concept together with you and support you in its realization. During operation, we perform regular testing to ensure the permanent function of the safety systems. If changes are made to existing machines, we provide you with support on everything from the safety-related planning to renewed commissioning.

Through our services, you benefit from our many years of experience in the area of machine safety and our extensive industry and application knowledge. Efficient safety-related solutions for every phase of a machine's life cycle are thereby created together.

## Our service offerings



### Status check: 'safety technology on machines and systems'

- Our experts analyze the safety-related condition of your machinery and check whether the current safety-related requirements are satisfied in accordance with the current state of the art.
- In the event of deviations, we provide recommendations on what corrections can be performed so as to comply with legal requirements.

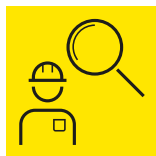

### Risk assessment and hazard assessment

In accordance with applicable directives, the manufacturer of a machine is required to perform a risk assessment. This also applies in the case of significant modifications or extensions of machines.

The national regulations for the operation of machines require employers to conduct a hazard assessment before using work equipment and to update this assessment at regular intervals according to the current state of the art.

- Our experts support you in identifying the dangers, in assessing and evaluating the risks as well as in defining the risk-reducing measures.



### Inspection of protective devices

- Within the scope of the initial or regular inspection, we check the condition, mounting and correct function of the protective device as well as the correct integration in the safe part of the machine control
- We summarize the results of the tests in a detailed report. If necessary, this includes practically oriented suggestions on how deviations can be corrected.



### Stopping time measurement

For the correct placement of the protective device, the required minimum distance between protective device and dangerous movements is to be calculated. To do this, the stopping time of the machine must be known. With the stopping time measurement, we determine this value reliably.

- By measuring the stopping time within the scope of regular inspections, any wear, such in brake components, can be detected in good time.



### Status check: 'CE marking of machines'

During the development of machines, the specifications from the machinery directive must be adhered to and documented by the manufacturer. This is confirmed with the Declaration of Conformity and the CE marking.

- We check the documentation for completeness and give recommendations of how any deviations can be corrected.

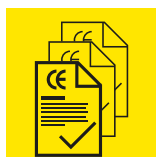

### Conformity assessment in accordance with the European machinery directive

The machinery directive defines the procedure for the design and construction of machines for satisfying the applicable safety and health protection requirements. This is a prerequisite for the Declaration of Conformity and the CE marking.

- We help you comply with and implement the legal requirements of the machinery directive.



### Safety concept and safety design

The measures necessary for risk minimization are known from the risk analysis.

The safety concept and the safety functions are developed on the basis of these requirements.

- With our extensive industry knowledge and our many years of safety-related experience, we create practically oriented concept proposals for you and support you during their implementation.



### Verification and validation

To avoid errors during the implementation of safety functions, both the hardware as well as the software must be checked to determine whether the requirements of the functional specification were met completely and correctly. The function test of all safety functions is to be performed according to the validation plan.

- We support you during the planning, development and execution of the function tests as well as with the creation of the required documentation.

# Technical data

## Safety laser scanner



RSL 410, RSL 420, RSL 425



RSL 430, RSL 440, RSL 445



RSL 420P, RSL 450P, RSL 455P

	RSL 410, RSL 420, RSL 425	RSL 430, RSL 440, RSL 445	RSL 420P, RSL 450P, RSL 455P	
<b>General</b>	Protective field range	3.0 / 4.5 / 6.25 / 8.25 m	3.0 / 4.5 / 6.25 / 8.25 m	3.0 / 4.5 / 6.25 / 8.25 m
	Scanning angle	270°	270°	270°
	Angular resolution	0.1°	0.1°	0.1°
	Warning field range (at 10% diffuse reflection)	20 m	20 m	20 m
	Resolution, selectable	30 / 40 / 50 / 60 / 70 / 150 mm	30 / 40 / 50 / 60 / 70 / 150 mm	30 / 40 / 50 / 60 / 70 / 150 mm
	Response time	≥ 80 ms	≥ 80 ms	≥ 120 ms
	Safety	Type 2, SIL 3, PL d	Type 2, SIL 3, PL d	Type 2, SIL 3, PL d
	Dimensions, incl. connection unit (W × H × D)	140 × 149 × 140 mm	140 × 149 × 140 mm	140 × 169 × 140 mm
	Temperature range	0 ... +50°	0 ... +50°	0 ... +50°
Certifications	CE cULUS TÜV TÜV	CE cULUS TÜV TÜV	CE cULUS TÜV	
<b>Functions</b>	Safety-related switching outputs	1	2	RSL 420P: PROFIsafe, 1 protective field RSL 450P, 455P: PROFIsafe, 4 simultaneous protective fields
	Number of field pairs (1 protective field + 1 warning field)	RSL 410: 1 RSL 420: 10	RSL 430: 10+10 RSL 440, 445: 100	RSL 420P: 10 RSL 450P, 455P: 100
	Number of 4-field sets (1 protective field + 3 warning fields)	RSL 410: 1 RSL 420: 10	10	RSL 420P: 10
	Number of 4-field sets (2 protective fields + 2 warning fields)	–	50	RSL 450P, 455P: 50 (Warning fields can be evaluated as protective fields)
	Number of independent sensor configurations	1	RSL 430: 2 RSL 440, 445: 10	RSL 420P: 1 RSL 450P, 455P: 10
	Plain-text display, integrated electronic spirit level	X	X	X
	Configurable signalling outputs	RSL 410: 3 RSL 420: 4	9	All status information can be called up
UDP data output optimized for AGV navigation, configurable, 50 m operating range	RSL 425 Distance and signal strength, angular resolution 0.1°	RSL 445 Distance and signal strength, angular resolution 0.1°	RSL 455P Distance and signal strength, angular resolution 0.1°	
<b>Interfaces / connection</b>	Connection unit (removable, with integrated configuration memory)	RSL 410: M12 connector, RSL 420, 425: cable or connector, 16-pin	Cable or connector, 29-pin	3x M12 connector for 2-port switch and power supply or 4x M12 connector with additional voltage output   AIDA variant with push-pull connectors, communication via copper or fiber-optic cable
	Interfaces for configuration and diagnosis	Ethernet TCP/IP, Bluetooth RSL 420, 425: USB	Ethernet TCP/IP, USB, Bluetooth	Ethernet TCP/IP, USB, Bluetooth
	PROFINET	–	–	Conformance class C   Network load class III   PROFINET device according to specification V2.3.4   GSDML according to specification V2.3.2
	More properties	Technology for robust operation   Contactor monitoring (EDM), start/restart interlock (RES)   Vertical access guarding with reference contour monitoring   Park function (protective field switch-off, RSL 420 and RSL 425)	Technology for robust operation   Contactor monitoring (EDM), start/restart interlock (RES)   Vertical access guarding with reference contour monitoring   Park function (protective field switch-off)	Technology for robust operation   Start/restart interlock (RES)   Vertical access guarding with reference contour monitoring   Park function (protective field switch-off)



Safety light curtains



MLC 310, MLC 320  
MLC 510, MLC 520



MLC 520-S



MLC 530



MLC 530-SPG

		MLC 300: type 2 MLC 500: type 4	Type 4	Type 4	Type 4
General	Type in accordance with EN IEC 61496	MLC 300: type 2 MLC 500: type 4	Type 4	Type 4	Type 4
	SIL in accordance with IEC 61508 and EN IEC 62061 (SILCL)	MLC 300: SIL 1 MLC 500: SIL 3	SIL 3	SIL 3	SIL 3
	Performance Level (PL) in accordance with EN ISO 13849-1	MLC 300: PL c MLC 500: PL e	PL e	PL e	PL e
	Resolution	14 / 20 / 30 / 40 / 90 mm	14 / 24 mm	14 / 20 / 30 / 40 / 90 mm	30 / 40 / 90 mm
	Operating range	6 / 15 / 10 / 20 / 20 m	6 m	6 / 15 / 10 / 20 / 20 m	10 / 20 / 20 m
	Protective field height	150 ... 3,000 mm	150 ... 1,200 mm	150 ... 3,000 mm	150 ... 3,000 mm
	Response time	MLC 300: 3 – 51 ms MLC 500: 3 – 64 ms	7 – 17 ms	3 – 64 ms	3 – 64 ms
	Profile cross section	29 × 35 mm	15.4 × 32.6 mm	29 × 35 mm	29 × 35 mm
	Temperature range	MLC 300: 0 ... +55°C MLC 500: –30 ... +55°C	–10 ... +55°C	–30 ... +55°C	–30 ... +55°C
	Safety-related switching outputs (OSSDs)	2 PNP transistor outputs	2 PNP transistor outputs	2 PNP transistor outputs	2 PNP transistor outputs
	Connection type	M12 connector	160 mm cable with M12 connector	M12 connector	M12 connector
Certifications					
Functions	Range reduction on the transmitter	X		X	X
	Switchable transmission channels	X		X	X
	LED indicator	X	X	X	X
	7-segment display	MLC 320, 520		X	X
	Configuration by means of wiring	X	X	X	X
	Automatic start / restart	X	X	X	
	Start / restart interlock (RES)	MLC 320, 520	X	X	X
	Contacting monitoring (EDM)	MLC 320, 520	X		
	Beam blanking, fixed or movable			X	X
	Muting function, integrated			X (2-sensor time-controlled)	X (Smart Process Gating, see page 26)
	Linkage of safety output, multiscan			X	
Versions for special applications	Extra slim design		X		
	Cascadable (triple)	MLC 520	X		
	AIDA version	MLC 510			
	AS-i Safety interface	MLC 510			
	EX protection marking acc. to EN 60079	MLC 520 (group II, cat 3D and 3G)			
	Protection classes IP 67 / IP 69K, mounted in protective tube	MLC 510			
	Extra shock / vibration resistant	MLC 500		X	

Safety light curtains



MLD 310, MLD 320  
MLD 510, MLD 520



MLD 330, MLD 335  
MLD 530, MLD 535

Single light beam safety devices



MLD 510, MLD 520,  
MLD 530



SLS 46C type 4  
SLS 46C type 2

	MLD 310, MLD 320 MLD 510, MLD 520	MLD 330, MLD 335 MLD 530, MLD 535	MLD 510, MLD 520, MLD 530	SLS 46C type 4 SLS 46C type 2	
<b>General</b>	Type in accordance with EN IEC 61496	MLD 300: type 2 MLD 500: type 4	MLD 300: type 2 MLD 500: type 4	Type 4 (self-monitoring)	Type 4, in combination with an MSI-TRM safety relay Type 2, in combination with a safety monitoring device
	SIL in accordance with IEC 61508 and EN IEC 62061 (SILCL)	MLD 300: SIL 1 MLD 500: SIL 3	MLD 300: SIL 1 MLD 500: SIL 3	SIL 3	SIL 3 (SLS 46C type 4 with an MSI-TRM safety relay) SIL 1 (SLS 46C type 2 with a safety monitoring device)
	Performance Level (PL) in accordance with EN ISO 13849-1	MLD 300: PL c MLD 500: PL e	MLD 300: PL c MLD 500: PL e	PL e	PL e (SLS 46C type 4 with an MSI-TRM safety relay) PL c (SLS 46C type 2 with a safety monitoring device)
	Number of beams / beam distance	2 / 500 mm 3 / 400 mm 4 / 300 mm	2 / 500 mm 3 / 400 mm 4 / 300 mm	1	1
	Operating range	0.5 ... 50 m or 20 ... 70 m (transmitter-receiver systems) 0.5 ... 6/8 m (transceiver systems)	0.5 ... 50 m or 20 ... 70 m (transmitter-receiver systems) 0.5 ... 6/8 m (transceiver systems)	0.5 ... 70 m 20 ... 100 m	0.25 ... 40 m 5 ... 70 m
	Dimensions	Profile cross section 52 x 65 mm	Profile cross section 52 x 65 mm	52 x 65 x 193 mm	20.5 x 77 x 44 mm
	Temperature range	-30 ... +55 °C	-30 ... +55 °C	-30 ... +55 °C	-30 ... +60 °C
	Safety-related switching outputs	2 PNP transistor outputs (OSSDs)	2 PNP transistor outputs (OSSDs)	2 PNP transistor outputs (OSSDs)	2 push-pull transistor outputs
	Connection type	M12 connector	M12 connector	M12 connector	2 m cable, M12 connector
	Certifications				
<b>Functions</b>	LED indicator	X	X	X	X
	7-segment display	MLD 320, 520	X	MLD 520, 530	
	Start / restart interlock (RES)	MLD 320, 520	X	MLD 520, 530	
	Contactormonitoring (EDM)	MLD 320, 520	X	MLD 520, 530	
	Configuration by means of wiring	MLD 320, 520	X	MLD 520, 530	
	Laser alignment aid (optional for transmitter-receiver systems)	X	X	X	
	2-sensor muting (time and sequence controlled)		MLD 330, 530 MLD 335, 535	MLD 530	
	4-sensor muting (time-controlled)		MLD 335, 535		
	Muting-timeout extension up to 100 hours		X	MLD 530	
	Integrated status indicator light (optional)	X	X		
AS-i Safety interface	MLD 510		MLD 510		

**Safety radar system**



**LBK**

<b>General</b>	SIL in accordance with EN IEC 62061 (SILCL)	SIL 2
	Performance Level (PL) in accordance with EN ISO 13849-1	PL d
	Category in accordance with EN ISO 13849-1	Category 2
	Operating principle	FMCW (frequency modulated continuous wave) for movement detection
	Response time	100 ms
	Temperature range	-40 °C ... +60 °C
	Certifications	<b>IMQ</b> <b>CE</b>
<b>Sensor</b>	Operating range	0 ... 4 m
	Adjustable protective field and warning field size	1 ... 4 m
	Angle of radiation	Wide: 110° (horizontal plane) 30° (vertical plane) Narrow: 50° (horizontal plane) 15° (vertical plane)
	Frequency range	24.0 ... 24.5 GHz
	Emitted power	≤ 13 dBm
	Dimensions (W × H × D)	85 × 85 × 53 mm
	Connection	M12, 5-pin
	Power supply	Via controller
	Protection class	IP 67
	<b>Controller</b>	Safety-related switching outputs
Signalling outputs		2 relay outputs
Inputs		3 (2-channel)
Number of sensors in a system		6
Number of configurable groups (1 to 6 sensors)		3
Deactivation of individual groups		X
Start / restart interlock (RES)		X
Dimensions (W × H × D)		166.25 × 92.6 × 46.5 mm
Protection class		IP 20
Interfaces for configuration and diagnosis		USB 2.0 Micro USB

**Safety switches**



**S20, S200**

**Safety position switches**



**S300**

**Safety hinge switches**



**S400, S410**

**Safety locking device**



**L100, L200**

	S20, S200	S300	S400, S410	L100, L200	
<b>General</b>	Type in accordance with EN ISO 14119	Type 2 interlock device without guard interlocking	Type 1 interlock device without guard interlocking	Type 1 interlock device without guard interlocking	Type 2 interlock device with guard interlocking
	Safety	For safety applications with performance level up to PL e/SIL 3	For safety applications with performance level up to PL e/SIL 3	For safety applications with performance level up to PL e/SIL 3	For safety applications with performance level up to PL e/SIL 3
	Housing / Protection class	Technopolymer (S20) or metal (S200) / both IP 67	Technopolymer or metal, both IP 67	Metal, IP 67 / IP 69K	Technopolymer or metal, both IP67
	Actuator	Mechanical tongue, with low coding level in accordance with EN ISO 14119	Actuated by uncoded cam in accordance with EN ISO 14119	Encapsulated position switch inside hinge	Mechanical tongue, with low coding level in accordance with EN ISO 14119
	Locking type, locking force acc. to ISO 14119				With either quiescent current principle or open circuit current principle L100: F <sub>1max</sub> 1,100 N L200: F <sub>1max</sub> 2,800 N
	Connection type	Cable entry M20 × 1.5 (S20: optional 3-way), M12 connector	Cable entry M20 × 1.5 (1- or 3-way), M12 connector	Cable or M12 connector, top, bottom, at wall side	Cable entry M20 × 1.5 (3-way)
	Certifications				
<b>Functions</b>	Function	Safety switches with separate actuator	Safety switches with plunger and roll actuator	Safety switches and door hinge in one component	Safety switches with guard locking
	Integration in safety circuit	Positive-opening contacts for integration in a safety circuit	Positive-opening contacts for integration in a safety circuit	Positive-opening contacts for integration in a safety circuit	Positive-opening contacts for integration in the safety circuit
	Actuator	Up to 8 different actuators	6 different plunger and roll actuators		Multiple heavy-duty actuators
	Status indicator				LED status display (L200)
	Escape release				Models with escape unlocking (L200)
	Special functions		Switching direction selectable	Additional hinge (without contacts)	
<b>Features</b>		Universal use with 5 actuator approach directions	Universal use with individually set actuator approach directions and angles in 10° grid	High protection against tampering through encapsulated position switch	Universal use with 5 actuator approach directions
		Easy mounting with standard construction	Extremely durable / robust	Elegant design for discreet and effective integration in the system	Robust design for big machinery and systems in harsh ambient conditions (L200)
		High-quality silver contacts for long life expectancy	Various contact blocks	Hidden cable routing thanks to connection on rear side	
		Various contact blocks		180° maximum opening angle of the protective device, adjustable switching point	
			Model S410 with wide fork dimension for special materials, e.g., glass		

Safety locking device



L250

Safety locking device



L300

Type 4 interlock device with guard interlocking	Type 4 interlock device with guard interlocking
Performance Level PL e / SIL 3 with a single device	Performance Level PL e / SIL 3 with a single device
Technopolymer IP 67 / IP 69K	Metal, IP 67 / IP 69K, IP 65 for integrated operational controls
Mechanical tongue with RFID-encoded actuator in accordance with EN ISO 14119; AC-L250-SCA: low AC-L250-UCA: high	Mechanical tongue with RFID-encoded actuator in accordance with EN ISO 14119; AC-L300-SCA: low AC-L300-UCA: high
With either quiescent current principle or open circuit current principle, F <sub>1max</sub> 2,100 N	With either quiescent current principle or open circuit current principle, F <sub>1max</sub> 9,750 N
M12 connector, various outgoing lines	Cable entry M20 × 1.5 (3-way), M12 (8- or 12-pin), M23 (19-pin)
Safety switches with guard locking	Safety switches with guard locking
OSSD safety-related switching outputs	OSSD safety-related switching outputs
Contactless actuation through RFID technology	Contactless actuation through RFID technology
LED status display	LED status display
Models with escape unlocking	Models with escape unlocking
	Models with up to three integrated operational controls
Large center opening for actuator shaft	Large center opening for actuator shaft
Flexibly mounted actuator enables secure closing even with warped doors	Flexibly mounted actuator enables secure closing even with warped doors
Variable installation options: Front and side mounting with just two screws   Flexible and independent alignment of connection unit and escape unlocking	Variable installation options: Flexible and independent alignment of device head and escape unlocking
	Lock-out/tag-out functionality
	Door handle for simple mounting of switches and actuators

Safety proximity sensors, magnetically coded



MC 300

Safety proximity sensors, RFID-coded



RD 800

<b>General</b>	Type in accordance with EN ISO 14119	Type 4 interlock device without guard interlocking	Type 4 interlock device without guard interlocking
	Category in accordance with EN ISO 13849-1	Up to 4 (depending on the number of sensors)	4
	Performance Level (PL) in accordance with EN ISO 13849-1	Up to PL e (depending on the number of sensors)	PL e with a single device
	Dimensions (housing)	M30 × 36 mm (MC 330) 36 × 26 × 13 mm (MC 336) 88 × 25 × 13 mm (MC 388)	87.5 × 25 × 18 mm (sensor) 45 × 25 × 18 mm (actuator)
	Assured operating distances (Seo, Sar)	< 6 mm, > 14 mm (MC 330) < 3 mm, > 11 mm (MC 336) < 6 mm, > 30 mm (MC 388)	12 mm, 10 mm
	Switching tolerance	± 1 mm	
	Contact type	2 NC or 1 NC + 1 NO	
	Code type	Actuator with low coding level in accordance with EN ISO 14119	
	Connection type	M8, M12, cable, cable+M12	
	Min. approach speed of actuator towards sensor	50 mm/s	
Response time	3 ms	3 ms	
Protection class	IP 67	IP 67 / IP 69K	
Certifications			
<b>Functions</b>	Encoding	Magnetically coded	RFID coded, for maximum protection against manipulation
	Status indicator	LED	4 LEDs
	Signalling contact	X	X
	Programming input		For teaching-in actuators
<b>Features</b>		Contactless actuation without mechanical contacts   Long life expectancy   Insensitive to soiling	Contactless actuation without mechanical contacts   Long life expectancy   Insensitive to soiling   Series connection possible



Safety control



MSI 410



MSI 420  
MSI 430

Extension modules



MSI-EM-I8  
MSI-EM-IO84



MSI-FB-EtherCAT  
MSI-FB-PROFIBUS  
MSI-FB-CANopen

	MSI 410	MSI 420 MSI 430	MSI-EM-I8 MSI-EM-IO84	MSI-FB-EtherCAT MSI-FB-PROFIBUS MSI-FB-CANopen	
<b>General</b>	Device type/function	Safety control base module	Safety control base module	Safe extension module	Gateway
	Category / Performance Level (PL) in accordance with EN ISO 13849-1	4 / PL e	4 / PL e	4 / PL e	
	SIL in accordance with IEC 61508 and EN IEC 62061 (SILCL)	3	3	3	
	Inputs / outputs / Inputs or outputs, configurable	20 / 4 / -	16 / 4 / 4	8 / - / - (EM-I8) 8 / 4 / - (EM-IO84)	
	Maximum switching power per output	4 A	4 A	4 A	
	Test outputs / signal generators	4 / 4	4 / 4	8 / 2 (EM-I8) 2 / 2 (EM-IO84)	
	Interfaces for configuration and diagnosis	USB mini	USB mini, Ethernet TCP/IP		
	Fieldbus protocols		MSI 430: PROFINET IO, EtherNet/IP and Modbus TCP integrated		EtherCAT PROFIBUS-DP CANopen
	Connection	Screw or spring-cage terminals, pluggable	Screw or spring-cage terminals, pluggable	Screw or spring-cage terminals, pluggable	2x RJ45 sockets 1x RS485 (Sub-D) Screw terminals, 5-pin
	Dimensions	45 x 96 x 115 mm	45 x 96 x 115 mm	22.5 x 93.7 x 120.8 mm	22.5 x 96.5 x 121 mm
Certifications					
<b>Functions</b>	Modular expansion	Expandable to up to 116 safe inputs   56 safe outputs and 2 gateway modules	Expandable to up to 116 safe inputs   56 safe outputs and 2 gateway modules	Each base module can be expanded by up to 12 freely selectable extension modules	Each base module can be expanded with up to 2 gateway modules
	Function indicator	1 LED per I/O and 4 LEDs for module status	1 LED per I/O and 4 LEDs for module status	1 LED per I/O and 1 LED for module status	3-5 LEDs for module status
	Memory	Removable program memory in SD card format, 512 MB	Removable program memory in SD card format, 512 MB		
	Options	F50 model with special function blocks for press control and safe movement monitoring, such as SLS, SSM and SSR acc. to EN 61800-5-2	F50 model with special function blocks for press control and safe movement monitoring, such as SLS, SSM and SSR acc. to EN 61800-5-2	MSI-EM-IO84NP non-safe extension module with 4 inputs   4 outputs   4 inputs or outputs, configurable   For economical actuation of non-safety relevant elements, e.g., signal lights	
<b>Software</b>	Configuration	Via MSI.designer configuration software (license-free)	Via MSI.designer configuration software (license-free)		
	Function blocks	40 certified function blocks	40 certified function blocks		
	Function blocks per project	Up to 300	Up to 300		
	Other functions	Integrated simulation with logic analyzer   Configurable report   Online diagnosis	Integrated simulation with logic analyzer   Configurable report   Online diagnosis		

Safety relays



		MSI-SR-2H21	MSI-SR-ES31	MSI-SR-LC21 / DT03 / DT30	MSI-SR-LC31AR MSI-SR-LC31MR	MSI-SR4B MSI-SR5B	MSI-RM2 MSI-SR-CM32	MSI-SR-CM42R	MSI-SR-CM43 MSI-CM52	MSI-TR1/2 MSI-TRM
<b>General</b>	Device type/function	Evaluation unit					Output extension for OSSDs	Contact extension		Evaluation unit, for periodic testing
	Sensors/ application (Input signals)	Two-hand control device Type III C, EN 574	E-Stop, safety switches with relay contacts	E-Stop Safety switches: – with relay contacts – with OSSD outputs – with Reed contacts Safety light curtain Safety laser scanner			Safety light barrier, Safety laser scanner, Safety switch with OSSD outputs. Extension for safety controls (CM32)	Extension for safety controls		Testable optoelectronic protective devices of type 2 (MSI-TR1/2) Testable optoelectronic protective devices of type 4 (MSI-TRM)
<b>Functions</b>	Category/ Performance Level (PL) in accordance with EN ISO 13849-1	4/PL e	3/PL d	4/PL e	4/PL e	4/PL e	4/PL e	4/PL e	3/PL d (CM43) 4/PL e (CM52)	4/PL e
	SIL in accordance with IEC 61508 and EN IEC 62061 (SILCL)	3	2	3	3	3	3	3	2 (CM43) 3 (CM52)	3
	Number of release contacts (NC)	2	3	2	3	3 (SR4) 2 (SR5)	2 (RM2, change-over contact) 3 (CM32)	2 x 2	4 (CM43) 5 (CM52)	2
	Number of signal contacts (NO)	1	2	1	1	1 (SR4) – (SR5)	1 (RM2) 2 (CM32)	2 x 1	3 (CM43) 2 (CM52)	2 (semi-conductor)
	Manual/automatic restart	Through synchronous actuation	M/A	M/A	M (MR) A (AR)	M/A	A	A	A	M/A
	Contact monitoring (EDM)	X	X	X	X	X				X
	Release time	50 ms	60 ms	25 ms	10 ms	10 ms	10 ms (RM2) 20 ms (CM32)	15 ms	40 ms (CM43) 20 ms (CM52)	20 ms (TR) 30 ms (TRM)
	Max. continuous current per path	6 A	8 A	6 A	8 A	3 A (SR4) 2 A (SR5)	3 A (RM2) 6 A (CM32)	6 A	6 A	3 A
	Special functions			Delay DT03: 0.15 – 3 s DT30: 0.1 – 30 s		SR5: Parallel evaluation of 2 sensors		2 extensions in one device		1 or 2 input circuits, up to 3 sensors each

# Suitable products

## Product-specific mounting brackets



### For simple mounting and alignment of the sensors

Example for MLD multiple light beam safety devices



Example for MLC safety light curtains



Example for SLS single light beam safety devices



### Connection boxes

For simple connection of muting sensors

## Accessories for RSL 400 safety laser scanner



### Mounting system

For horizontal and vertical alignment



### Loop guard

To protect the optics cover, in conjunction with the mounting system



### Mounting bracket for floor mounting

For scanning heights of 150 mm, 300 mm and 75–375 mm



### Alignment aids

For easy alignment over large distances



### Optical / acoustic signaling devices

For status visualization, pre-mounted or modular



### Power supplies

PSU power supply units and PLM redundancy modules for optimum power supply of the sensors, 1- and 3-pin



### Connection and interconnection cables

With standard M8 and M12 connection



### User-configurable connectors and Y distribution boxes

With M12 connection



### Passive distribution boxes

MD distribution box for signal bundling and distribution

# Our company

## Everything at a glance

In a constantly changing industrial world, we work together with our customers to find the best solution for their sensor applications: innovatively, precisely and efficiently.

### Key figures

<b>Foundation</b>	1963
<b>Company structure</b>	GmbH + Co. KG, wholly family-owned
<b>Executive management</b>	Ulrich Balbach
<b>Headquarters</b>	Owen, Germany
<b>Distribution companies</b>	21
<b>Production locations</b>	5
<b>Technological competence centers</b>	3
<b>Distributors</b>	40
<b>Employees</b>	> 1,200

### Product range

- Switching sensors
- Measuring sensors
- Safety
- Identification
- Data transmission
- Network and connection technology
- Industrial image processing
- Accessories and supplementary products

### Focus industries

- Intralogistics
- Packaging industry
- Machine tools
- Automotive industry
- Laboratory automation



### Leuze electronic GmbH + Co. KG

In der Braike 1  
73277 Owen  
Phone: +49 7021 573-0  
Fax: +49 7021 573-199  
E-mail: [info@leuze.com](mailto:info@leuze.com)  
[www.leuze.com](http://www.leuze.com)











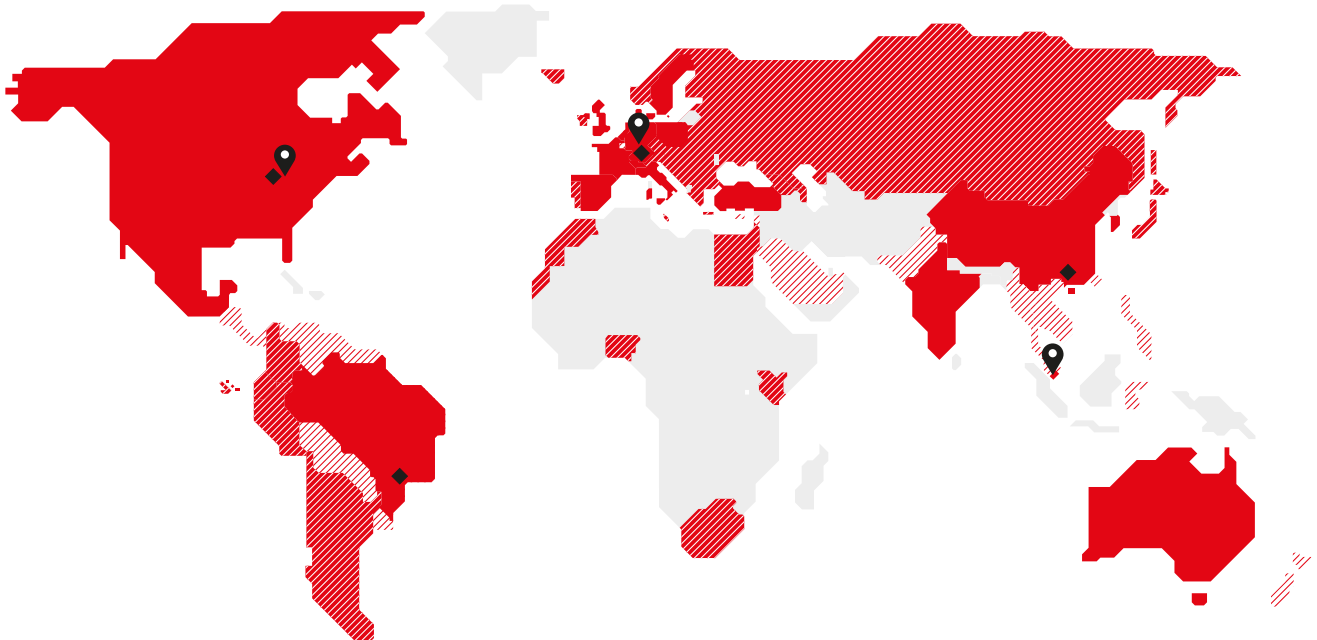

# Our Locations

## At work for you around the world

Your success is our motivation. We therefore place great value on always being personally, quickly, and easily accessible to you. We produce on four continents, allowing us to offer you reliable product availability.



-  Technological competence centers
-  Production locations
-  Subsidiaries
-  Distributor
-  Distribution through neighboring country

### Technological competence centers

Owen, Germany  
 New Hudson/Detroit, USA  
 Singapore

### Production locations

Owen, Germany  
 Unterstadion, Germany  
 New Hudson/Detroit, USA  
 Shenzhen, China  
 São Paulo, Brazil

### Distribution companies

Australia/New Zealand	Italy
Belgium	Mexico
Brazil	Poland
China	Singapore
Denmark/Sweden	South Korea
France	Spain
Germany – headquarters	Switzerland
Germany – distribution company	The Netherlands
Great Britain	Turkey
Hong Kong	USA/Canada
India	

## Our product range at a glance

### Switching sensors

- Optical sensors
- Inductive switches
- Capacitive sensors
- Ultrasonic sensors
- Fiber optic sensors
- Forked sensors
- Light curtains
- Special sensors

### Measuring sensors

- Distance sensors
- Sensors for positioning
- 3D sensors
- Light curtains
- Bar code positioning systems
- Forked sensors

### Safety

- Safety laser scanners
- Safety light curtains
- Single and multiple light beam safety devices
- Safe locking devices, switches and proximity sensors
- Safety PLCs and relays
- Machine safety services

### Identification

- Bar code identification
- 2D-code identification
- RF identification

### Data transmission

- Optical data transmission systems

### Network and connection technology

- Connection technology
- Modular connection units

### Industrial image processing

- Light section sensors
- Smart camera

### Accessories and supplementary products

- Signaling devices
- Mounting systems
- Reflectors

## Your contact with us

### Leuze electronic GmbH + Co. KG

In der Braike 1, 73277 Owen

Phone +49 7021 573-0

Fax +49 7021 573-199

info@leuze.com

[www.leuze.com](http://www.leuze.com)