

Technical data sheet

Polarized retro-reflective photoelectric

Part no.: 50117925

PRK28/4P

Contents

- Technical data
- Dimensioned drawings
- Electrical connection
- Diagrams
- Operation and display
- Reflectors & reflective tapes
- Part number code
- Notes
- Further information
- Accessories



Figure can vary



Technical data

Basic data

| | |
|---------------------|----------------------|
| Series | 28 |
| Operating principle | Reflection principle |

Optical data

| | |
|--------------------------|---|
| Operating range | Guaranteed operating range |
| Operating range | 0.02 ... 4.5 m, With reflector TK(S) 100x100 |
| Operating range limit | Typical operating range |
| Operating range limit | 0.02 ... 6 m, With reflector TK(S) 100x100 |
| Light source | LED, Red |
| LED light wavelength | 620 nm |
| LED group | Exempt group (in acc. with EN 62471) |
| Transmitted-signal shape | Pulsed |

Electrical data

| | |
|--------------------|------------------------------|
| Protective circuit | Polarity reversal protection |
| | Short circuit protected |

Performance data

| | |
|----------------------|--|
| Supply voltage U_B | 10 ... 30 V, DC, Incl. residual ripple |
| Residual ripple | 0 ... 15 %, From U_B |
| Open-circuit current | 0 ... 20 mA |

Outputs

| | |
|-------------------------------------|------------|
| Number of digital switching outputs | 2 Piece(s) |
|-------------------------------------|------------|

Switching outputs

| | |
|-------------------------|--------------------------|
| Voltage type | DC |
| Switching current, max. | 100 mA |
| Switching voltage | high: $\geq(U_B - 2.5V)$ |
| | low: $\leq 2.5V$ |

Switching output 1

| | |
|---------------------|---------------------------|
| Assignment | Connection 1, conductor 4 |
| Switching element | Transistor, PNP |
| Switching principle | Light switching |

Switching output 2

| | |
|---------------------|---------------------------|
| Assignment | Connection 1, conductor 2 |
| Switching element | Transistor, PNP |
| Switching principle | Dark switching |

Timing

| | |
|---------------------|--------|
| Switching frequency | 500 Hz |
| Response time | 1 ms |
| Readiness delay | 300 ms |

Connection 1

| | |
|----------------------|---------------------|
| Function | Signal OUT |
| | Voltage supply |
| Type of connection | Cable |
| Cable length | 2,000 mm |
| Sheathing material | PUR |
| Cable color | Black |
| Number of conductors | 4 -wire |
| Wire cross section | 0.2 mm ² |

Mechanical data

| | |
|-----------------------|-----------------|
| Dimension (W x H x L) | 15 mm x 46.5 mm |
| Thread size | M18 |
| Length | 31.8 mm |
| Housing material | Plastic |
| Plastic housing | ABS |
| Lens cover material | Plastic |
| Net weight | 75 g |
| Housing color | Black |
| | Red |

Operation and display

| | |
|-----------------|------------|
| Type of display | LED |
| Number of LEDs | 2 Piece(s) |

Environmental data

| | |
|--------------------------------|---------------|
| Ambient temperature, operation | -40 ... 60 °C |
| Ambient temperature, storage | -40 ... 70 °C |

Certifications

| | |
|----------------------|---------------|
| Degree of protection | IP 67 |
| Protection class | III |
| Certifications | c UL US |
| Standards applied | IEC 60947-5-2 |

Classification

| | |
|-----------------------|----------|
| Customs tariff number | 85365019 |
| eCl@ss 5.1.4 | 27270902 |
| eCl@ss 8.0 | 27270902 |
| eCl@ss 9.0 | 27270902 |
| eCl@ss 10.0 | 27270902 |
| eCl@ss 11.0 | 27270902 |
| ETIM 5.0 | EC002717 |
| ETIM 6.0 | EC002717 |
| ETIM 7.0 | EC002717 |

Dimensioned drawings

All dimensions in millimeters

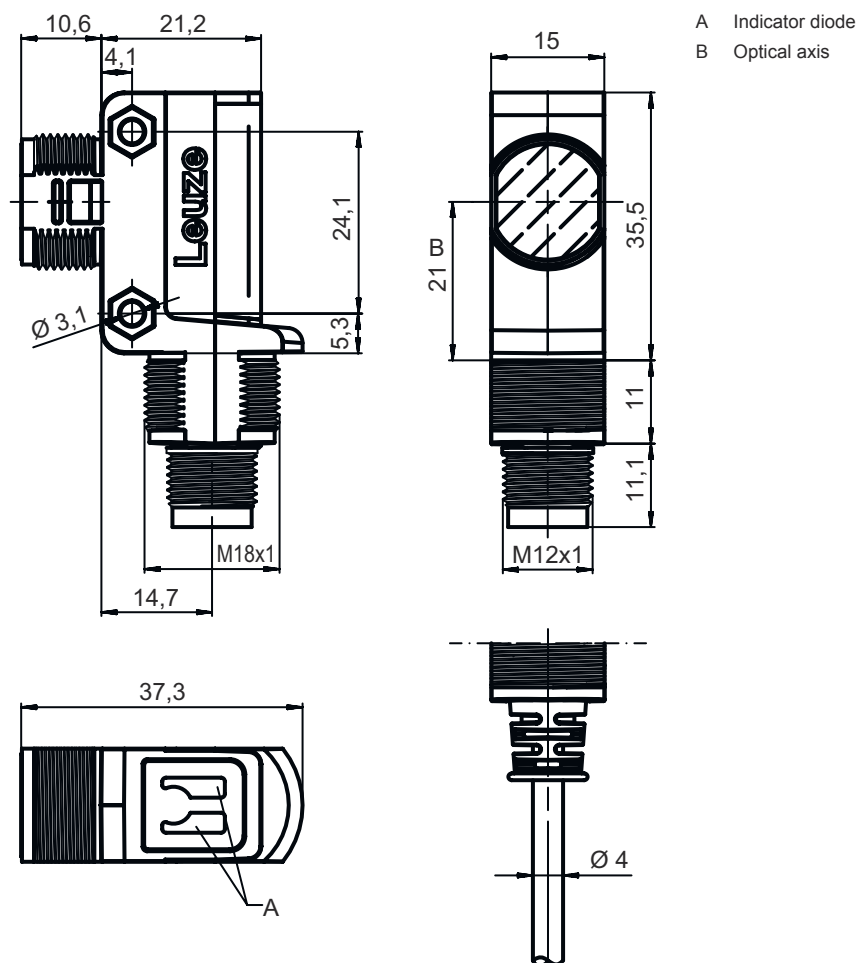

Electrical connection

Connection 1

| | |
|----------------------|---------------------|
| Function | Signal OUT |
| | Voltage supply |
| Type of connection | Cable |
| Cable length | 2,000 mm |
| Sheathing material | PUR |
| Cable color | Black |
| Number of conductors | 4 -wire |
| Wire cross section | 0.2 mm ² |

Conductor color

Conductor assignment

| | |
|-------|-------|
| Brown | V+ |
| White | OUT 2 |
| Blue | GND |
| Black | OUT 1 |

Diagrams

Typ. response behavior (TKS100x100)

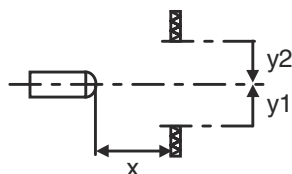
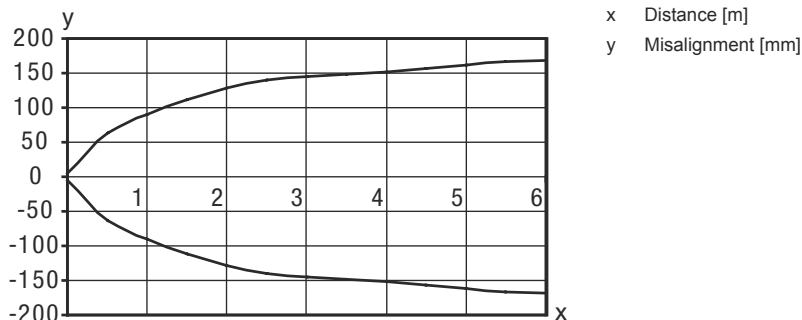

Typ. function reserve

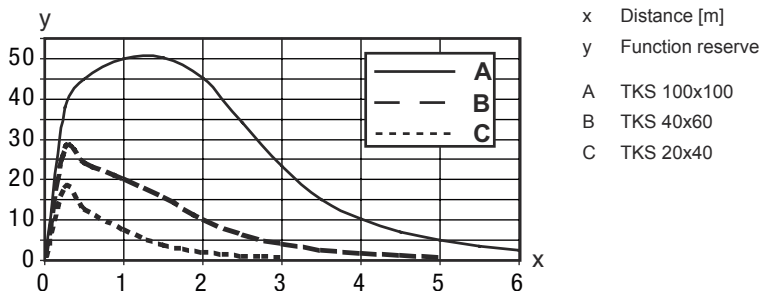

Operation and display

| LED | Display | Meaning |
|-----|--------------------------|-----------------------|
| 1 | Green, continuous light | Operational readiness |
| 2 | Yellow, continuous light | Light path free |
| | Yellow, flashing | No function reserve |

Reflectors & reflective tapes

| Part no. | Designation | Operating range Operating range | Description |
|----------|---------------|------------------------------------|---|
| 50108300 | REF 4-A-50x50 | 0.08 ... 1.4 m 0.08 ... 2 m | Design: Rectangular Reflective surface: 50 mm x 50 mm Material: Plastic Chemical designation of the material: PMMA Fastening: Self-adhesive |



Reflectors & reflective tapes

| | Part no. | Designation | Operating range Operating range | Description |
|---|----------|-------------|------------------------------------|--|
|  | 50003192 | TK 100x100 | 0.02 ... 4.5 m 0.02 ... 6 m | Design: Rectangular Reflective surface: 96 mm x 96 mm Triple reflector size: 4 mm Material: Plastic Base material: Plastic Chemical designation of the material: PMMA8N Fastening: Adhesive |
|  | 50003189 | TK 30x50 | 0.03 ... 1.9 m 0.03 ... 2.5 m | Design: Rectangular Reflective surface: 29 mm x 45 mm Triple reflector size: 4 mm Material: Plastic Base material: Plastic Chemical designation of the material: PMMA8N Fastening: Adhesive |
|  | 50024127 | TK 82.2 | 0.05 ... 3.6 m 0.05 ... 4.5 m | Design: Round Triple reflector size: 4 mm Reflection surface diameter: 79 mm Material: Plastic Base material: Plastic Chemical designation of the material: PMMA8N Fastening: Through-hole mounting, Adhesive |
|  | 50022816 | TKS 100X100 | 0.02 ... 4.5 m 0.02 ... 6 m | Design: Rectangular Reflective surface: 96 mm x 96 mm Triple reflector size: 4 mm Material: Plastic Base material: Plastic Chemical designation of the material: PMMA8N Fastening: Through-hole mounting, Adhesive |
|  | 50081283 | TKS 20X40 | 0.04 ... 1.6 m 0.04 ... 2.2 m | Design: Rectangular Reflective surface: 16 mm x 38 mm Triple reflector size: 2.3 mm Material: Plastic Base material: Plastic Chemical designation of the material: PMMA8N Fastening: Through-hole mounting, Adhesive |
|  | 50023525 | TKS 30X50 | 0.03 ... 1.9 m 0.03 ... 2.5 m | Design: Rectangular Reflective surface: 27 mm x 44 mm Triple reflector size: 3 mm Material: Plastic Base material: Plastic Chemical designation of the material: PMMA8N Fastening: Through-hole mounting, Adhesive |
|  | 50040820 | TKS 40X60 | 0.02 ... 3 m 0.02 ... 4 m | Design: Rectangular Reflective surface: 37 mm x 56 mm Triple reflector size: 4 mm Material: Plastic Base material: Plastic Chemical designation of the material: PMMA8N Fastening: Through-hole mounting, Adhesive |

Part number code

Part designation: AAA28d.E/ ff-hh

AAA28

Operating principle / construction

LS28: throughbeam photoelectric sensor transmitter
 LE28: throughbeam photoelectric sensor receiver
 ET28: energetic diffuse reflection sensor
 FT28: diffuse reflection sensor with fading
 PRK28: retro-reflective photoelectric sensor with polarization filter

Part number code

| | |
|-----------|---|
| d | Light type n/a: red light l: infrared light |
| E | Equipment 3: teach-in via button |
| ff | Switching output / function / OUT1OUT2 (OUT1 = pin 4, OUT2 = pin 2) 2: NPN transistor output, light switching N: NPN transistor output, dark switching 4: PNP transistor output, light switching P: PNP transistor output, dark switching D: deactivation input (deactivation with low signal) 9: deactivation input (deactivation with high signal) |
| hh | n/a: cable, standard length 2000 mm, 4-wire 200-M12: cable, length 200 mm with M12 connector, 4-pin, axial (plug) |

| Note | |
|------|--|
| | A list with all available device types can be found on the Leuze website at www.leuze.com . |

Notes

| ⚠ Observe intended use! | |
|-------------------------|---|
| | <ul style="list-style-type: none"> This product is not a safety sensor and is not intended as personnel protection. The product may only be put into operation by competent persons. Only use the product in accordance with its intended use. |

| For UL applications: | |
|----------------------|---|
| | <ul style="list-style-type: none"> For UL applications, use is only permitted in Class 2 circuits in accordance with the NEC (National Electric Code). These proximity switches shall be used with UL Listed Cable assemblies rated 30V, 0.5A min, in the field installation, or equivalent (categories: CYJV/ CYJV7 or PVVA/PVVA7) |

Further information

- Sum of the output currents for both outputs, 50 mA for ambient temperatures > 40 °C

Accessories

Mounting technology - Mounting brackets



| | Part no. | Designation | Article | Description |
|--|----------|---------------|---------------------|--|
| | 50124651 | BT 205M-10SET | Mounting device set | Design of mounting device: Angle, L-shape Fastening, at system: Through-hole mounting Mounting bracket, at device: Screw type Type of mounting device: Rigid Material: Metal |

Accessories

Mounting technology - Rod mounts

| | Part no. | Designation | Article | Description |
|---|----------|--------------|-----------------|--|
|  | 50117255 | BTU 200M-D12 | Mounting system | Design of mounting device: Mounting system Fastening, at system: For 12 mm rod, Sheet-metal mounting Mounting bracket, at device: Screw type, Suited for M3 screws Type of mounting device: Clampable, Adjustable, Turning, 360° Material: Metal |

Standard reflectors

| | Part no. | Designation | Article | Description |
|--|----------|-------------|-----------|--|
|  | 50081283 | TKS 20X40 | Reflector | Design: Rectangular Reflective surface: 16 mm x 38 mm Triple reflector size: 2.3 mm Material: Plastic Base material: Plastic Chemical designation of the material: PMMA8N Fastening: Through-hole mounting, Adhesive |
|  | 50040820 | TKS 40X60 | Reflector | Design: Rectangular Reflective surface: 37 mm x 56 mm Triple reflector size: 4 mm Material: Plastic Base material: Plastic Chemical designation of the material: PMMA8N Fastening: Through-hole mounting, Adhesive |

Reflective tapes for standard applications

| | Part no. | Designation | Article | Description |
|---|----------|---------------|-----------------|---|
|  | 50108300 | REF 4-A-50x50 | Reflective tape | Design: Rectangular Reflective surface: 50 mm x 50 mm Material: Plastic Chemical designation of the material: PMMA Fastening: Self-adhesive |

Note



A list with all available accessories can be found on the Leuze website in the Download tab of the article detailed page.