

Technical data sheet

Contour measurement system

Part no.: 50143556
CMS748i-ENC1-0480-0960

Contents

- Set consists of
- Technical data
- Dimensioned drawings
- Electrical connection
- Diagrams
- Notes
- Accessories



Figure can vary



Set consists of

	Quantity	Part no.	Designation	Article	Description
	2	424417	BT-2P40	Mounting bracket set	Bore hole 1: M6 Bore hole 2: M6 Design of mounting device: Mounting clamp Fastening, at system: Groove mounting Mounting bracket, at device: Groove mounting Type of mounting device: Clampable Material: Metal
	1	50118742	CML730i-R05-480.A/L-M12	Light curtain receiver	Operating range: 0.1 ... 4.5 m Interface: IO-Link Connection: Connector, M12, Axial, 8 -pin
	1	50118748	CML730i-R05-960.A/L-M12	Light curtain receiver	Operating range: 0.1 ... 4.5 m Interface: PROFINET, IO-Link Connection: Connector, M12, Axial, 8 -pin
	1	50118581	CML730i-T05-480.A-M12	Light curtain transmitter	Operating range: 0.1 ... 4 m Connection: Connector, M12, Axial, 5 -pin
	1	50118587	CML730i-T05-960.A-M12	Light curtain transmitter	Operating range: 0.1 ... 4 m Connection: Connector, M12, Axial, 5 -pin
	2	50129781	KDS DN-M12-5A-M12-5A-P3-050	Interconnection cable	Suitable for interface: IO-Link, DeviceNet, CANopen Connection 1: Connector, M12, Axial, Female, A-coded, 5 -pin Connection 2: Connector, M12, Axial, Male, A-coded, 5 -pin Shielded: Yes Cable length: 5,000 mm Sheathing material: PUR
	3	50135146	KDS S-M12-8A-M12-8A-P1-050	Interconnection cable	Connection 1: Connector, M12, Axial, Female, A-coded, 8 -pin Connection 2: Connector, M12, Axial, Male, A-coded, 8 -pin Shielded: Yes Cable length: 5,000 mm Sheathing material: PUR
	1	50144568	LMSMA35500024KH 10M16	Rotary encoder	
	1	50142931	LSC748-ENC-100	Switch cabinet	Supply voltage: 100 ... 263 V, AC Switching inputs: 4 Piece(s) Switching outputs: 4 Piece(s) Connections: 8 Piece(s)

Technical data

Basic data

Series	CMS 7xxi
Contains	1x dongle CMS700 1x rotary encoder
Order guide	Additional models on request

Functions

Functions	For a minimum object height ≥ 5 mm
-----------	---

Optical data

Operating range	Guaranteed operating range
Operating range	0.1 ... 4.5 m
Operating range, transparent media	0.1 ... 1.75 m
Operating range limit	Typical operating range
Operating range limit	0.1 ... 6 m
Measurement field length 1	480 mm
Measurement field length 2	960 mm
Beam spacing	5 mm

Electrical data

Protective circuit	Polarity reversal protection
	Short circuit protected
	Transient protection
Output current, continuous current per channel, max.	100 mA

Performance data

Supply voltage U_B	100 ... 263 V, AC
Open-circuit current	250 mA

Inputs

Number of digital switching inputs	4 Piece(s)
------------------------------------	------------

Switching inputs

Type	Digital switching input
Voltage type	DC
Switching voltage	24 V, VIN

Outputs

Number of digital switching outputs	4 Piece(s)
-------------------------------------	------------

Switching outputs

Type	Digital switching output
Voltage type	AC
Switching voltage	24 V, VIN

Interface

Type	EtherNet TCP/IP, PROFINET
Ethernet Function	Configuration / process data
Profinet Function	Configuration / process data

Connection

Number of connections	8 Piece(s)
-----------------------	------------

Connection 1

Function	Earthing
Type of connection	Earthing strap
Material	Metal

Connection 2

Function	Voltage supply
Type of connection	Harting connector
Material	Metal

Connection 3

Function	Width measuring light curtain connection
Type of connection	Connector
Thread size	M12
Type	Male
Material	Metal
No. of pins	8 -pin
Encoding	A-coded

Connection 4

Function	Height measuring light curtain connection
Type of connection	Connector
Thread size	M12
Type	Male
Material	Metal
No. of pins	8 -pin
Encoding	A-coded

Connection 5

Function	Rotary encoder connection (not in combination with length measuring light curtain)
Type of connection	Connector
Thread size	M12
Type	Male
Material	Metal
No. of pins	8 -pin
Encoding	A-coded

Connection 6

Function	External Ethernet TCP/IP connection
Type of connection	Connector
Thread size	M12
Type	Male
Material	Metal
No. of pins	4 -pin
Encoding	A-coded

Connection 7

Function	PROFINET IN connection (optional)
Type of connection	Connector
Thread size	M12
Type	Male
Material	Metal
No. of pins	4 -pin
Encoding	A-coded

Technical data

Connection 8

Function	PROFINET OUT connection (optional)
Type of connection	Connector
Thread size	M12
Type	Male
Material	Metal
No. of pins	4 -pin
Encoding	A-coded

Mechanical data

Design	Cubic
Housing material	Metal
Metal housing	Aluminum
Lens cover material	Plastic
Housing color	Gray
	Red

Note Dimensions of individual set items, see dimensioned drawings

Operation and display

Note	This information refers to the switch cabinet
Type of display	LED
Number of LEDs	3 Piece(s)
Type of configuration	performed via webConfig
Operational controls	Rotary switch

Environmental data

Ambient temperature, operation	0 ... 45 °C
Ambient temperature, storage	-20 ... 70 °C

Classification

Customs tariff number	90314990
eCl@ss 5.1.4	27270910
eCl@ss 8.0	27270910
eCl@ss 9.0	27270910
eCl@ss 10.0	27270910
eCl@ss 11.0	27270910
ETIM 5.0	EC002549
ETIM 6.0	EC002549
ETIM 7.0	EC002549

Dimensioned drawings

All dimensions in millimeters

Light curtain transmitter and receiver



- | | | | |
|---|--|---|--|
| A | Beam spacing 5 mm | L | Profile length 1 = 488 mm
Profile length 2 = 968 mm |
| B | Measurement field length 1 = 480 mm
Measurement field length 2 = 960 mm | T | Transmitter |
| F | M6 thread | R | Receiver |
| G | Fastening groove | Y | 2.5 mm |

Dimensioned drawings

Switch cabinet

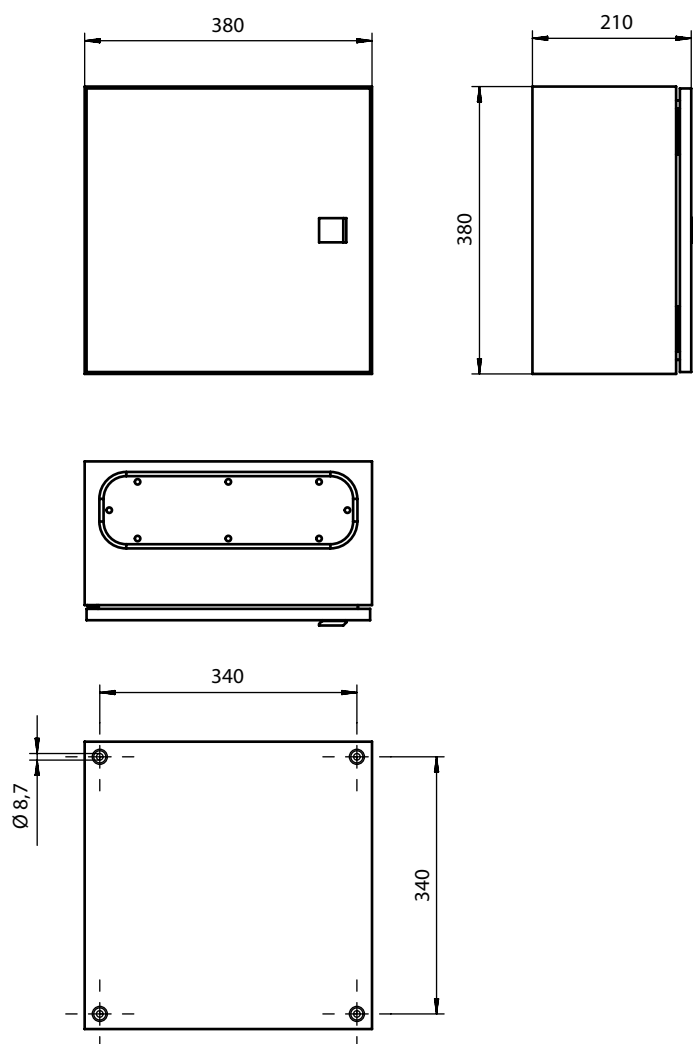

Dimensioned drawings

Rotary encoders

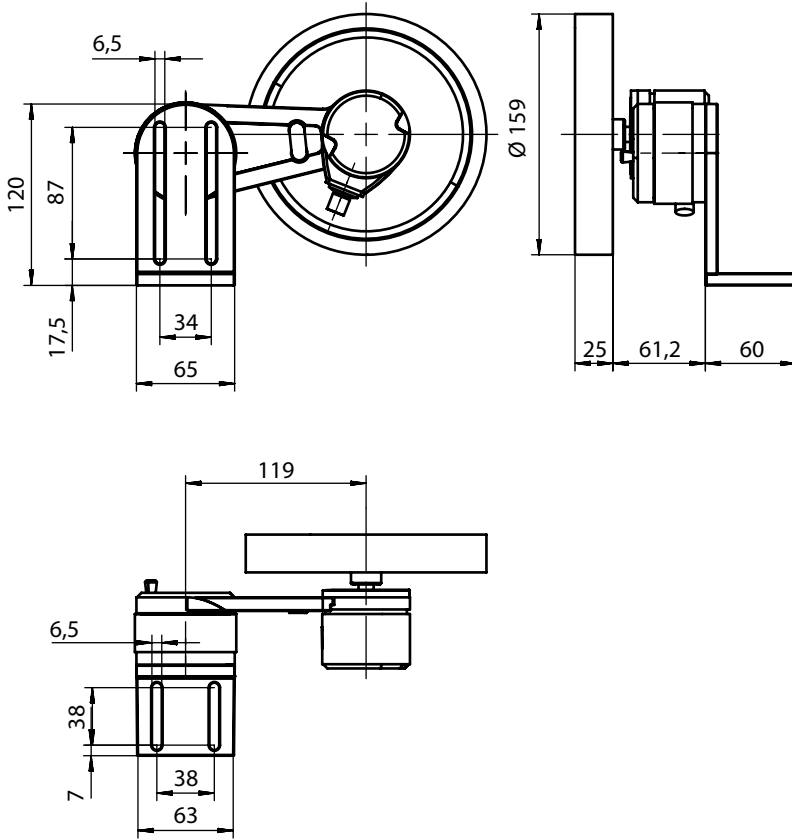

Dimensioned drawings

Rotary encoders



Electrical connection

Connection 1

Function	Earthing
Type of connection	Earthing strap
Material	Metal

Connection 2

XS1000

Function	Voltage supply
Type of connection	Harting connector
Material	Metal

Connection 3

XS1301

Function	Width measuring light curtain connection
Type of connection	Connector
Thread size	M12
Type	Male
Material	Metal
No. of pins	8 -pin
Encoding	A-coded

Electrical connection

Pin Pin assignment

1	V+
2	IO1
3	GND
4	IO-Link
5	IO2
6	IO3
7	IO4
8	GND

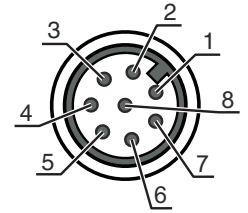

Connection 4

XS1302

Function	Height measuring light curtain connection
Type of connection	Connector
Thread size	M12
Type	Male
Material	Metal
No. of pins	8 -pin
Encoding	A-coded

Pin Pin assignment

1	V+
2	IO1
3	GND
4	IO-Link
5	IO2
6	IO3
7	IO4
8	GND

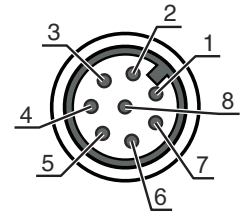

Connection 5

XS1400

Function	Rotary encoder connection (not in combination with length measuring light curtain)
Type of connection	Connector
Thread size	M12
Type	Male
Material	Metal
No. of pins	8 -pin
Encoding	A-coded

Pin Pin assignment

1	U-
2	U+
3	A
4	B
5	N
6	A inv.
7	B inv.
8	N inv.
9	Shield

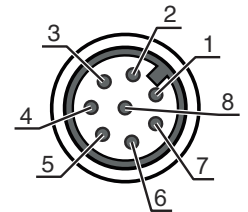

Electrical connection

Connection 6

XETH1

Function	External Ethernet TCP/IP connection
Type of connection	Connector
Thread size	M12
Type	Male
Material	Metal
No. of pins	4 -pin
Encoding	A-coded

Pin	Pin assignment
-----	----------------

1	TD+
2	RD+
3	TD-
4	RD-



Connection 7

XS1100

Function	PROFINET IN connection (optional)
Type of connection	Connector
Thread size	M12
Type	Male
Material	Metal
No. of pins	4 -pin
Encoding	A-coded

Pin	Pin assignment
-----	----------------

1	TD+
2	RD+
3	TD-
4	RD-

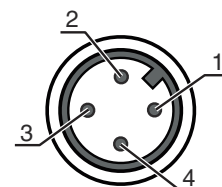

Connection 8

XS1101

Function	PROFINET OUT connection (optional)
Type of connection	Connector
Thread size	M12
Type	Male
Material	Metal
No. of pins	4 -pin
Encoding	A-coded

Pin	Pin assignment
-----	----------------

1	TD+
2	RD+
3	TD-
4	RD-

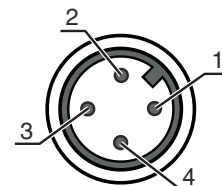

Diagrams



x Total measuring length from width and height measuring light curtain [mm]
 y Max. conveyor speed [m/s]





Notes

⚠ Observe intended use!

- ⚠ This product is not a safety sensor and is not intended as personnel protection.
- ⚠ The product may only be put into operation by competent persons.
- ⚠ Only use the product in accordance with its intended use.

Accessories

Connection technology - Interconnection cables

	Part no.	Designation	Article	Description
   	50135082	KSS ET-M12-4A-RJ45-A-P7-100	Interconnection cable	Suitable for interface: Ethernet Connection 1: Connector, M12, Axial, Male, D-coded, 4 -pin Connection 2: RJ45 Shielded: Yes Cable length: 10,000 mm Sheathing material: PUR

Accessories

	Part no.	Designation	Article	Description
	50135083	KSS ET-M12-4A-RJ45-A-P7-150	Interconnection cable	Suitable for interface: Ethernet Connection 1: Connector, M12, Axial, Male, D-coded, 4 -pin Connection 2: RJ45 Shielded: Yes Cable length: 15,000 mm Sheathing material: PUR
	50135084	KSS ET-M12-4A-RJ45-A-P7-300	Interconnection cable	Suitable for interface: Ethernet Connection 1: Connector, M12, Axial, Male, D-coded, 4 -pin Connection 2: RJ45 Shielded: Yes Cable length: 30,000 mm Sheathing material: PUR

Mounting technology - Other

Part no.	Designation	Article	Description
50143670	BT 708M-MRSET	Mounting device set	Design of mounting device: Profile kit Fastening, at system: Screw type / vertical Mounting bracket, at device: Groove mounting Type of mounting device: Rigid Material: Aluminum
50143671	BT 70EM-MRSET	Mounting device set	Design of mounting device: Profile kit Fastening, at system: Screw type / vertical Mounting bracket, at device: Groove mounting Type of mounting device: Rigid Material: Aluminum
50143669	BT 710M-MRSET	Mounting device set	Design of mounting device: Profile kit Fastening, at system: Screw type / vertical Mounting bracket, at device: Groove mounting Type of mounting device: Rigid Material: Aluminum
50142039	BT 712M-MRSET	Mounting device set	Design of mounting device: Profile kit Fastening, at system: Screw type / vertical Mounting bracket, at device: Groove mounting Type of mounting device: Rigid Material: Aluminum

Note



A list with all available accessories can be found on the Leuze website in the Download tab of the article detailed page.