

**IT 1450g**

**Hand-held bar code scanner**

en 01-2015/09 50130033



- Hand-held scanner for bar codes
- Large reading field for detecting codes
- Robust trigger button
- Built-in decoder
- Indicator upon successful read
- RS 232, USB and PS/2 interface
- Operating temperature from 0 to 40 °C
- Degree of protection IP 40

**Dimensioned drawing**

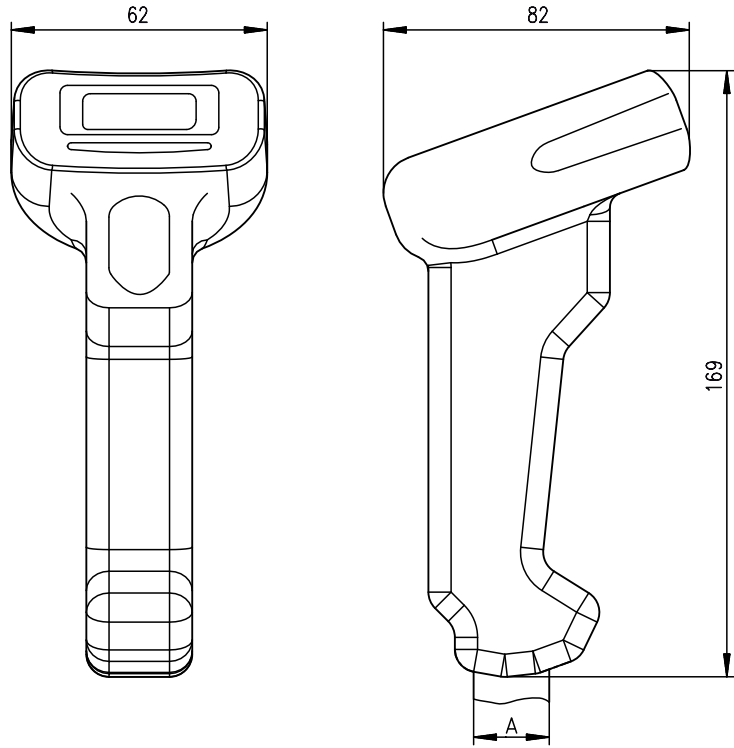

**A** Cable entry:  
depending on cable max. diameter 20mm,  
cable diameter 5mm

**Electrical connection**

for RS 232 cable

9-pin Sub-D	Signal	Connection for power supply unit	IT 1450g RJ41
2	TXD		4
3	RXD		5
5	GND	external	3
7	CTS		6
8	RTS		8
9	5VDC	internal	7

for USB cable

USB type A	Signal	IT 1450g RJ41
1	5VDC	7
2	Data -	10
3	Data +	9
4	GND	3

for PS/2 cable

Mini DIN connector	Mini DIN socket	Signal	IT 1450g RJ41
1	-	PC Data	4
2	2	NC	
3	3	GND	3
4	4	5VDC	7
5	-	PC Clock	5
6	6	NC	
-	1	KB data	8
-	5	KB clock	6



**Accessories**

- **RS 232 cable**  
Part no. 50115105
- **TTL-RS 232 cable**  
Part no. 50114517
- **PS/2 cable**  
Part no. 50114519
- **USB cable, 3m**  
Part no. 50114521
- **USB helix cable, 5m**  
Part no. 50114523
- **Power supply unit**  
Part no. 50114525

We reserve the right to make changes • DS\_IT1450g\_en\_50130033.fm

**Specifications**

**Electrical data**

Operating voltage  $U_B$  5VDC  
 Power consumption max. 2W

**Interfaces**

Interface type RS 232, PS/2 and USB  
 Trigger via button or serial command

**Types of codes**

Bar codes 2/5 Interleaved, Code 39, Code 128, Code 93, Codabar, UPC/EAN, GS1 Databar, Codablock

**Optical data**

Optical system Area Imager 640px x 480px  
 Contrast 35% (black/white)  
 Light source integrated diffuse LED 630nm  
 Reading distance 37 ... 260mm (UPC 100%)  
 Reading angle various tilt and rotational angles up to 70°

**Mechanical data**

Housing UL94V0 straight  
 Weight approx. 130g (without cable)  
 Dimensions 169x82x62mm  
 Shock resistance 30 falls from a height of 1.5m

**Environmental data**

Ambient temp. (operation) 0°C ... +40°C  
 Ambient temp. (storage) -40°C ... +60°C  
 Relative humidity 0 ... 95% (non-condensing)  
 Degree of protection IP 40  
 Certifications IEC 60950-1 (US-20771-UL)

**Reading field**

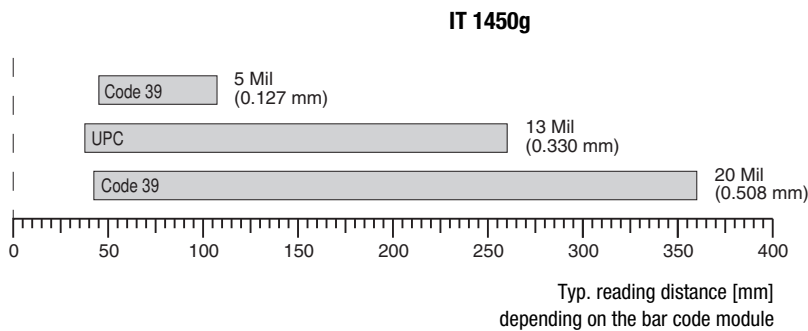

**Tables**

**Remarks**

**Operate in accordance with intended use!**

- ☞ The product may only be put into operation by competent persons.
- ☞ Only use the product in accordance with the intended use.

Ergonomically shaped hand-held scanner with integrated decoder for bar codes.

Data transmission via configurable RS 232 interface.

Or keyboard-wedge operation via PS/2 or USB interface.

**Order guide**

**Hand-held reader for bar codes (Standard Range)**

IT 1450g 1D-2 IT 1450g with RS 232, KBW and USB interface

**Part no.**

50130504

## Switching off the computer

Information on switching off and shutting down the connected computer - which must always be performed before connecting peripheral devices, such as a scanner - can be found in the appropriate operating instructions for your computer.

## Connecting the IT 1450g

The individual steps for installing the cable on the scanner are shown in the adjacent figure, which are described below.

1. To secure the interface cable to the scanner, proceed as follows:  
plug the RJ 41 connector into the socket on the bottom of the hand-held scanner.
2. Connect the interface cable to the appropriate connection socket on the computer.
3. You may need a power supply unit for supplying voltage; alternatively, you can use a cable which supplies voltage from the computer system. Use the pin assignments (see "Electrical connection" on page 1) to select the appropriate cable for your application.
4. Connect the power supply unit to the power socket (not necessary if voltage is supplied from the computer).
5. Use the code for the respective application to configure the hand-held scanner, see chapter "Parameterization".
6. Check the operational readiness of the scanner by pointing the scanning surface towards a flat surface and pulling the trigger. A red target line should now be visible. Now scan a sample label. The scanner emits an audible signal to confirm that the label has been read; if necessary, the data is now passed on to the computer.



Cable interlock

## Parameterization

The hand-held scanner can always be configured using bar codes. To do this, the bar code must first be selected on the package insert and then the trigger actuated in order to read the code. The configuration is then immediately accepted and executed.

Several of the most important configurations are listed in the following.

A second option is to configure the hand-held scanner with the USB and RS 232 interfaces with the aid of the **EZ Config** PC program. You can download and install this program from our homepage at [www.leuze.com](http://www.leuze.com).

The program can be used to make settings and transfer them to the hand-held scanner. The configuration can also be stored so that it can be reused at a later time.

More information can also be found in the user's guide.

The standard applications are described and summarized below.



### **Notice!**

Additional information on the device and short instructions can be found on the Internet at [www.leuze.com](http://www.leuze.com).

## Resetting the IT 1450g to factory settings

To reset all parameters to factory settings, scan the adjacent bar code.



### **Attention!**

All settings are lost!!!

You may then continue making settings or operation of the device.

## Trigger

To activate the read process, a trigger signal is to be sent via the serial RS 232 interface or USB interface (COM port emulation only). The command is to be sent at the set baud rate, parity, and data and stop bits.

The command for activation is: **SYN T CR** ASCII decimal values: 022; 084; 013

To cancel read readiness, send a deactivation.

The command for deactivation is: **SYN U CR** ASCII decimal values: 022; 085; 013

Following a successful read operation, the hand-held scanner deactivates itself.

The second option is activation via the built-in trigger button.

## Configuration for the Leuze standard protocol

Scan the adjacent 2D-code.

The hand-held scanner is set to the following transmission parameters:  
RS 232 transmission with 9,600 baud, 8 data bits, 1 stop bit, no parity,  
prefix <STX>, postfixes <CR><LF>.



**IT 1450g**

**Hand-held bar code scanner**

**Connecting the IT 1450g to the serial interface**

With voltage supply via PIN 9

Required parts:

- 1x IT 1450g 1D-2
- 1x 50114517 TTL RS 232 cable

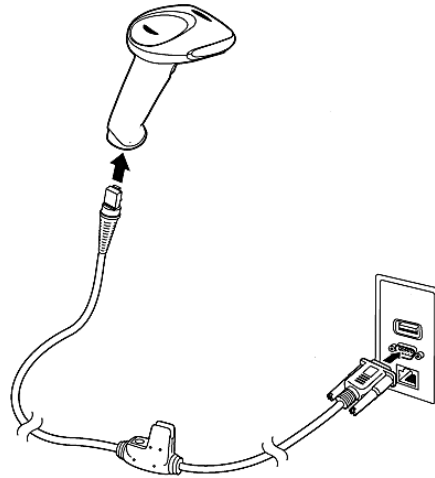

With voltage supply via power supply unit

Required parts:

- 1x IT 1450g 1D-2
- 1x 50114517 TTL RS 232 cable
- 1x 50114525 Power supply unit

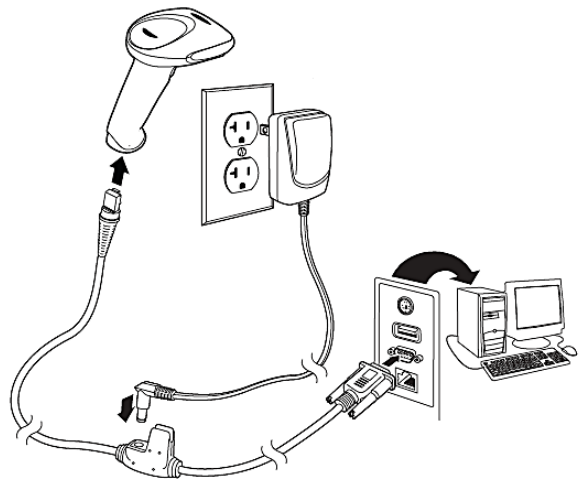

**Procedure:**

1. Switch off the PC.
2. Connect the interface cable to a free COM port (RS 232) on the computer, to the hand-held scanner as well as to the power supply unit.
3. Switch the PC back on.
4. Scan the adjacent bar code.

The hand-held scanner is set to the following transmission parameters:

RS 232 transmission with 9,600 baud, 8 data bits, 1 stop bit, no parity, postfixes <CR><LF>.

5. If necessary, adjust the transmission parameters of the used COM port to those of the hand-held scanner.



**Attention!**

We recommend connecting the hand-held scanner directly to a PC or to the MA 21 or MA 41... connection units. If connecting to other components, please note that a voltage level range of -12 ... +12V is maintained on the data lines!

## Connecting the IT 1450g to the MA 2xxi

### Required parts:

- 1x IT 1450g 1D-2
- 1x 50115105 RS 232 cable
- 1x 50113397 KB JST-HS-300
- 1x Connection unit **MA 2xxi** for the respective fieldbus system:
  - 50112893 MA 204i for PROFIBUS or
  - 50112892 MA 208i for Ethernet or
  - 50112891 MA 248i for PROFINET

### Procedure:

1. Insert the KB JST-HS-300 cable into the MA 2xxi.
2. Connect the interface cable to cable KB JST-HS-300.
3. Scan the adjacent 2D code.  
The hand-held scanner is set to the following transmission parameters:  
RS 232 transmission with 9600 baud, 8 data bits, 1 stop bit, no parity, postfixes <CR><LF>.



### Connecting the IT 1450g to the PS/2 interface

The operation of the IT 1450g in keyboard emulation mode is described in this section. With this operating mode, a PC keyboard is emulated. The read data are written directly into the currently activated program. The data can thereby be further processed in all standard programs.

#### Required parts:

- 1x **IT 1450g 1D-2**
- 1x **50114519 PS/2 cable**

#### **Procedure:**

1. Switch off the PC.
2. Disconnect the keyboard.
3. Plug in the IT 1450g hand-held scanner between the keyboard and the PC.
4. Switch the PC back on.
5. Scan the 2D code shown below.

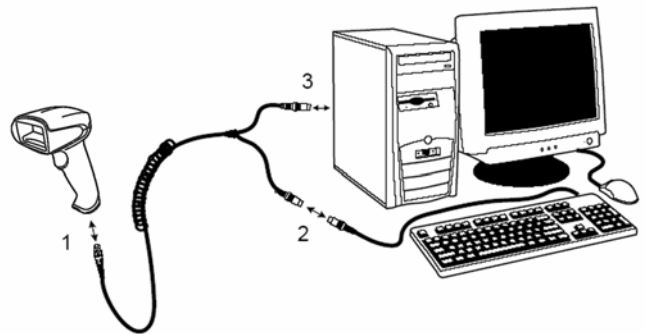
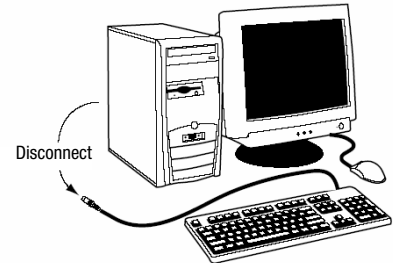

## Connecting the IT 1450g to the USB interface (keyboard emulation)

The operation of the IT 1450g in keyboard emulation mode on a USB port is described in this section. With this operating mode, a PC keyboard is emulated. The read data are written directly into the currently activated program. The data can thereby be further processed in all standard programs.

### Required parts:

- 1x IT 1450g 1D-2
- 1x 50114521 KB USB-1 IT190x (3m, straight)
- or
- 1x 50114523 KB USB-2 IT190x (5m, spiral)

### **Procedure:**

1. Plug the IT 1450g hand-held scanner into a free USB port.
2. The scanner acknowledges this connection with a beep.
3. Scan the 2D code shown below.

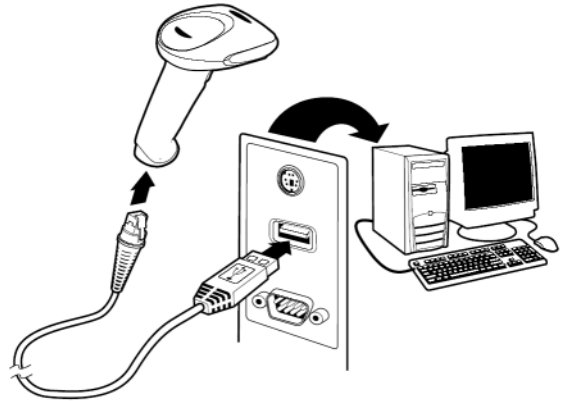



## Connecting the IT 1450g to the USB interface (COM port emulation)

The operation of the IT 1450g as a serial interface on a USB port is described in this chapter. With this operating mode, a COM interface is emulated. The read data are sent to a new COM interface. The drivers with which this COM interface is emulated can be downloaded from our homepage at [www.leuze.com](http://www.leuze.com). Thus, the data can be processed further in programs which expect data via COM interfaces.

### Required parts:

- 1x **IT 1450g 1D-2**
- 1x **50114521 KB USB-1 IT190x (3m, straight)**
- or
- 1x **50114523 KB USB-2 IT190x (5m, spiral)**

### Procedure:

1. Install the USB serial driver  
(current version available at [www.leuze.com](http://www.leuze.com)).
2. Plug the IT 1450g hand-held scanner into a free USB port.
3. The scanner acknowledges this connection with a beep.
4. Scan the 2D code shown below.
5. Open a terminal program or your program for the serial interface, select the new COM port, and make the following settings: baud rate 38,400, 8 data bits, 1 stop bit, no parity, postfix <CR>.

