

Technical data sheet

Stationary bar code reader

Part no.: 50116298
BCL 301i SF 100

Contents

- Technical data
- Dimensioned drawings
- Electrical connection
- Diagrams
- Operation and display
- Part number code
- Notes
- Accessories



Figure can vary



RS485



Technical data

Basic data

| | |
|--------|----------|
| Series | BCL 300i |
|--------|----------|

Functions

| | |
|-----------|---------------------------|
| Functions | Alignment mode |
| | AutoConfig |
| | AutoControl |
| | AutoReflAct |
| | Code fragment technology |
| | LED indicator |
| | Reference code comparison |

Characteristic parameters

| | |
|------|-----------|
| MTTF | 110 years |
|------|-----------|

Read data

| | |
|---|-----------------------------|
| Code types, readable | 2/5 Interleaved |
| | Codabar |
| | Code 128 |
| | Code 39 |
| | Code 93 |
| | EAN 8/13 |
| | GS1 Databar Expanded |
| | GS1 Databar Limited |
| | GS1 Databar Omnidirectional |
| | UPC |
| Scanning rate, typical | 1,000 scans/s |
| Bar codes per reading gate, max. number | 64 Piece(s) |

Optical data

| | |
|--|---|
| Reading distance | 70 ... 445 mm |
| Light source | Laser, Red |
| Laser light wavelength | 655 nm |
| Laser class | 2, IEC/EN 60825-1:2007 |
| Transmitted-signal shape | Continuous |
| Usable opening angle (reading field opening) | 60 ° |
| Modulus size | 0.3 ... 0.5 mm |
| Reading method | Line scanner with deflecting mirror |
| Beam deflection | By means of rotating polygon mirror wheel + deflecting mirror |
| Light beam exit | Lateral with deflecting mirror |

Electrical data

| | |
|-------------------------------------|------------------------------|
| Protective circuit | Polarity reversal protection |
| Performance data | |
| Supply voltage U_B | 18 ... 30 V, DC |
| Power consumption, max. | 4.5 W |
| Inputs/outputs selectable | |
| Output current, max. | 60 mA |
| Number of inputs/outputs selectable | 2 Piece(s) |
| Input current, max. | 8 mA |

Interface

| | |
|------|-----------------------|
| Type | MultiNet Plus, RS 485 |
|------|-----------------------|

RS 485

| | |
|-----------------------|----------------------|
| Function | Process |
| Transmission speed | 4,800 ... 115,200 Bd |
| Data format | Adjustable |
| Start bit | 1 |
| Data bit | 7, 8, 9 data bits |
| Stop bit | 1, 2 stop bits |
| Parity | Adjustable |
| Transmission protocol | Adjustable |
| Data encoding | ASCII |

Service interface

| | |
|------|-----|
| Type | USB |
|------|-----|

USB

| | |
|----------|----------------------------|
| Function | Configuration via software |
|----------|----------------------------|

Connection

| | |
|-----------------------|------------|
| Number of connections | 1 Piece(s) |
|-----------------------|------------|

Connection 1

| | |
|--------------------|----------------------|
| Function | BUS IN |
| | BUS OUT |
| | Connection to device |
| | Data interface |
| | PWR / SW IN / OUT |
| | Service interface |
| Type of connection | Plug connector |
| No. of pins | 32 -pin |
| Type | Male |

Mechanical data

| | |
|-----------------------|------------------------------|
| Design | Cubic |
| Dimension (W x H x L) | 103 mm x 44 mm x 96 mm |
| Housing material | Metal |
| Metal housing | Diecast aluminum |
| Lens cover material | Glass |
| Net weight | 350 g |
| Housing color | Black |
| | Red |
| Type of fastening | Dovetail grooves |
| | Fastening on back |
| | Via optional mounting device |

Operation and display

| | |
|-----------------------|-----------------|
| Type of display | LED |
| Number of LEDs | 2 Piece(s) |
| Type of configuration | Via web browser |

Environmental data

| | |
|------------------------------------|---------------|
| Ambient temperature, operation | 0 ... 40 °C |
| Ambient temperature, storage | -20 ... 70 °C |
| Relative humidity (non-condensing) | 0 ... 90 % |

Technical data

Certifications

| | |
|---|--------------------------------------|
| Degree of protection | IP 65 |
| Protection class | III |
| Certifications | c UL US |
| Test procedure for EMC in accordance with standard | EN 55022 EN 61000-4-2, -3, -4, -6 |
| Test procedure for shock in accordance with standard | IEC 60068-2-27, test Ea |
| Test procedure for continuous shock in accordance with standard | IEC 60068-2-29, test Eb |
| Test procedure for vibration in accordance with standard | IEC 60068-2-6, test Fc |

Classification

| | |
|-----------------------|----------|
| Customs tariff number | 84719000 |
| eCl@ss 5.1.4 | 27280102 |
| eCl@ss 8.0 | 27280102 |
| eCl@ss 9.0 | 27280102 |
| eCl@ss 10.0 | 27280102 |
| eCl@ss 11.0 | 27280102 |
| ETIM 5.0 | EC002550 |
| ETIM 6.0 | EC002550 |
| ETIM 7.0 | EC002550 |

Dimensioned drawings

All dimensions in millimeters

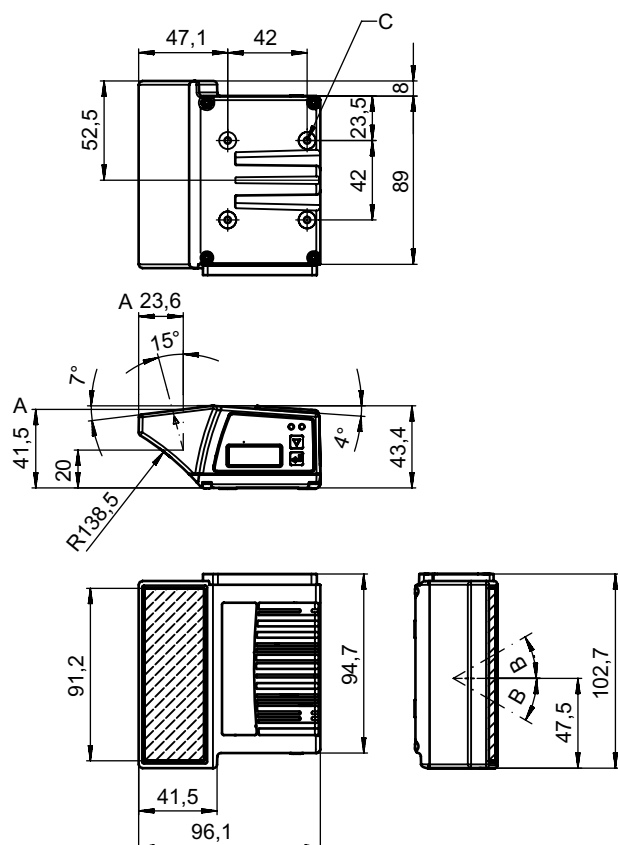

- A Optical axis
- B Deflection angle of the laser beam: $\pm 30^\circ$
- C M4 thread (5 deep)

Electrical connection

Connection 1

| | |
|---------------------------|----------------------|
| Function | BUS IN |
| | BUS OUT |
| | Connection to device |
| | Data interface |
| | PWR / SW IN / OUT |
| | Service interface |
| Type of connection | Plug connector |
| No. of pins | 32 -pin |
| Type | Male |

Diagrams

Reading field curve

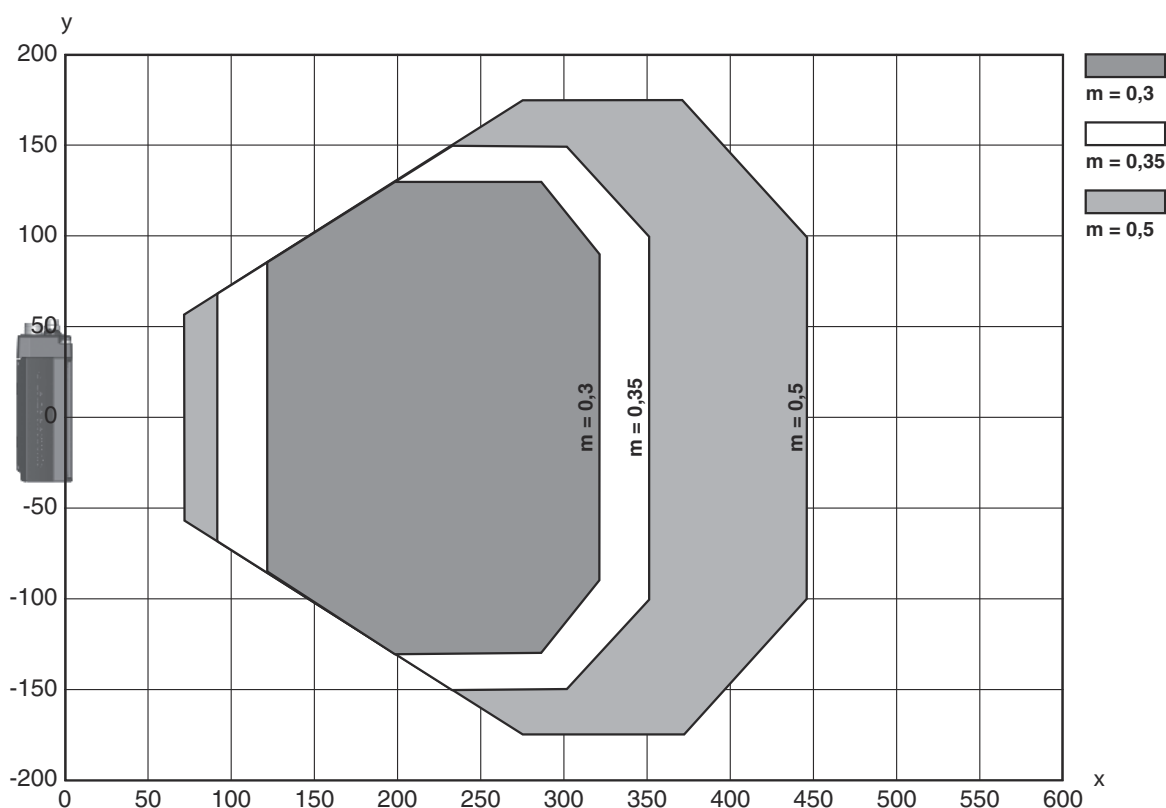

x Reading field distance [mm]
 y Reading field width [mm]

Operation and display

| LED | Display | Meaning |
|-------|---------------------------------------|---------------------------------|
| 1 PWR | Green, flashing | Device ok, initialization phase |
| | Green, continuous light | Device OK |
| | Green, briefly off - on | Reading successful |
| | green, briefly off - briefly red - on | Reading not successful |
| | Orange, continuous light | Service mode |
| | Red, flashing | Device OK, warning set |
| | Red, continuous light | Error, device error |

Operation and display

| LED | Display | Meaning |
|-------|-------------------------|---------------------|
| 2 BUS | Green, flashing | Initialization |
| | Green, continuous light | Bus operation ok |
| | Red, flashing | Communication error |
| | Red, continuous light | Bus error |

Part number code

Part designation: **BCL XXXX YYZ AAA BB CCCC**

| | |
|-------------|---|
| BCL | Operating principle BCL: bar code reader |
| XXXX | Series/interface (integrated fieldbus technology) 300i: RS 232 / RS 422 (stand-alone) 301i: RS 485 (multiNet slave) 304i: PROFIBUS DP 308i: EtherNet TCP/IP, UDP 348i: PROFINET RT 358i: EtherNet/IP |
| YY | Scanning principle S: line scanner (single line) R1: line scanner (raster) O: oscillating-mirror scanner (oscillating mirror) |
| Z | Optics N: High Density (close) M: Medium Density (medium distance) F: Low Density (remote) L: Long Range (very large distances) J: ink-jet (depending on the application) |
| AAA | Beam exit 100: lateral 102: front |
| BB | Special equipment D: with display H: with heating DH: optionally with display and heating P: plastic exit window |
| CCCC | Functions F007: optimized process data structure |

Note



A list with all available device types can be found on the Leuze website at www.leuze.com.

Notes



Observe intended use!



- ⌘ This product is not a safety sensor and is not intended as personnel protection.
- ⌘ The product may only be put into operation by competent persons.
- ⌘ Only use the product in accordance with its intended use.

Notes

WARNING! LASER RADIATION – CLASS 2 LASER PRODUCT

Do not stare into beam!
 The device satisfies the requirements of IEC 60825-1:2007 (EN 60825-1:2007) safety regulations for a product of laser class 2 as well as the U.S. 21 CFR 1040.10 regulations with deviations corresponding to "Laser Notice No. 50" from June 24, 2007.

- ☞ Never look directly into the laser beam or in the direction of reflected laser beams! If you look into the beam path over a longer time period, there is a risk of injury to the retina.
- ☞ Do not point the laser beam of the device at persons!
- ☞ Interrupt the laser beam using a non-transparent, non-reflective object if the laser beam is accidentally directed towards a person.
- ☞ When mounting and aligning the device, avoid reflections of the laser beam off reflective surfaces!
- ☞ CAUTION! Use of controls or adjustments or performance of procedures other than specified herein may result in hazardous light exposure.
- ☞ Observe the applicable statutory and local laser protection regulations.
- ☞ The device must not be tampered with and must not be changed in any way.
 There are no user-serviceable parts inside the device.
 Repairs must only be performed by Leuze electronic GmbH + Co. KG.

NOTE

Affix laser information and warning signs!
 Laser information and warning signs are affixed to the device. In addition, self-adhesive laser information and warning signs (stick-on labels) are supplied in several languages.

- ☞ Affix the laser information sheet to the device in the language appropriate for the place of use. When using the device in the US, use the stick-on label with the "Complies with 21 CFR 1040.10" note.
- ☞ Affix the laser information and warning signs near the device if no signs are attached to the device (e.g. because the device is too small) or if the attached laser information and warning signs are concealed due to the installation position.
- ☞ Affix the laser information and warning signs so that they are legible without exposing the reader to the laser radiation of the device or other optical radiation.



Accessories

Connection technology - Connection cables

| | Part no. | Designation | Article | Description |
|--|----------|---------------------|------------------|---|
| | 50135243 | KD PB-M12-4A-P3-050 | Connection cable | Suitable for interface: PROFIBUS DP Connection 1: Connector, M12, Axial, Female, B-coded, 4 -pin Connection 2: Open end Shielded: Yes Cable length: 5,000 mm Sheathing material: PUR |
| | 50132079 | KD U-M12-5A-V1-050 | Connection cable | Connection 1: Connector, M12, Axial, Female, A-coded, 5 -pin Connection 2: Open end Shielded: No Cable length: 5,000 mm Sheathing material: PVC |
| | 50135248 | KS PB-M12-4A-P3-050 | Connection cable | Suitable for interface: PROFIBUS DP Connection 1: Connector, M12, Axial, Male, B-coded, 4 -pin Connection 2: Open end Shielded: Yes Cable length: 5,000 mm Sheathing material: PUR |

Accessories

Connection technology - Interconnection cables

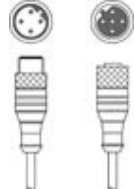
| | Part no. | Designation | Article | Description |
|---|------------|-----------------------------|-----------------------|---|
|  | 50114571 * | KB 301-3000 | Interconnection cable | Suitable for interface: RS 232, RS 422, RS 485 Connection 1: Socket connector Connection 2: JST ZHR, 10 -pin, 6 -pin Shielded: Yes Cable length: 3,000 mm Sheathing material: PVC |
|  | 50117011 | KB USB A - USB miniB | Service line | Suitable for interface: USB Connection 1: USB Connection 2: USB Shielded: Yes Cable length: 1,500 mm Sheathing material: PVC |
|  | 50135254 | KDS PB-M12-4A-M12-4A-P3-050 | Interconnection cable | Suitable for interface: PROFIBUS DP Connection 1: Connector, M12, Axial, Female, B-coded, 2 -pin Connection 2: Connector, M12, Axial, Male, B-coded, 4 -pin Shielded: Yes Cable length: 5,000 mm Sheathing material: PUR |

* Necessary accessories, please order separately

Connection technology - Terminating resistors

| | Part no. | Designation | Article | Description |
|--|----------|-------------|-----------------|---|
|  | 50038539 | TS 02-4-SA | Terminator plug | Suitable for: MultiNet Plus, PROFIBUS DP Connection 1: Connector, M12, Axial, Male, B-coded, 4 -pin Function: Bus termination |

Mounting technology - Mounting brackets

| | Part no. | Designation | Article | Description |
|---|----------|-------------|-----------------|---|
|  | 50121433 | BT 300 W | Mounting device | Design of mounting device: Angle, L-shape Fastening, at system: Through-hole mounting Mounting bracket, at device: Screw type Type of mounting device: Adjustable Material: Metal |

Mounting technology - Rod mounts

| | Part no. | Designation | Article | Description |
|--|----------|-------------|-----------------|---|
|  | 50121435 | BT 56 - 1 | Mounting device | Functions: Static applications Design of mounting device: Mounting system Fastening, at system: For 12 mm rod, For 14 mm rod, For 16 mm rod Mounting bracket, at device: Clampable Material: Metal Tightening torque of the clamping jaws: 8 N·m |

Accessories





Mounting technology - Other

| | Part no. | Designation | Article | Description |
|---|----------|-------------|-----------------|---|
|  | 50124941 | BTU 0300M-W | Mounting device | Fastening, at system: Through-hole mounting Mounting bracket, at device: Clampable, Groove mounting, Suited for M4 screws Material: Metal |

Reflective tapes for standard applications

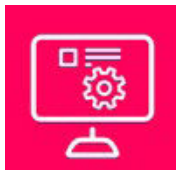
| | Part no. | Designation | Article | Description |
|---|----------|-----------------|-----------------|---|
|  | 50106119 | REF 4-A-100x100 | Reflective tape | Design: Rectangular Reflective surface: 100 mm x 100 mm Material: Plastic Chemical designation of the material: PMMA Fastening: Self-adhesive |

Services

| | Part no. | Designation | Article | Description |
|--|----------|-------------|--|---|
|  | S981020 | CS30-E-212 | Hourly rate for "Configuration" | Details: Compilation of the application data, selection and suggestion of suitable sensor system, drawing prepared as assembly sketch. Conditions: Completed questionnaire or project specifications with a description of the application have been provided. Restrictions: Travel and accommodation charged separately and according to expenditure. |
|  | S981014 | CS30-S-110 | Start-up support | Details: Performed at location of customer's choosing, duration: max. 10 hours. Conditions: Devices and connection cables are already mounted, price not including travel costs and, if applicable, accommodation expenses. Restrictions: No mechanical (mounting) and electrical (wiring) work performed, no changes (attachments, wiring, programming) to third-party components in the nearby environment. |
|  | S981019 | CS30-T-110 | Product training | Details: Location and content to be agreed upon, duration: max. 10 hours. Conditions: Price not including travel costs and, if applicable, accommodation expenses. Restrictions: Travel costs and accommodation expenses charged separately and according to expenditure. |
|  | S981021 | CS30-V-212 | Hourly rate for "Bar code qualification" | Details: REA evaluation with creation of a test report, evaluation of the code quality. Conditions: Original bar codes to be provided by the client. |

Note



A list with all available accessories can be found on the Leuze website in the Download tab of the article detailed page.