

Technical data sheet

Stationary 2D-code reader

Part no.: 50141796
DCR 202i FIX-M1-102-I3-G

Contents

- Technical data
- Dimensioned drawings
- Electrical connection
- Diagrams
- Operation and display
- Part number code
- Notes
- Accessories



Figure can vary



Technical data

Basic data

| | |
|--------|----------|
| Series | DCR 200i |
| Chip | CMOS |

Functions

| | |
|--------------------|---------------------|
| Software functions | Reading of 1D codes |
| | Reading of 2D codes |

Read data

| | |
|----------------------|-----------------------------|
| Code types, readable | 2/5 Interleaved |
| | Aztec |
| | Codabar |
| | Code 128 |
| | Code 32 |
| | Code 39 |
| | Code 93 |
| | Data Matrix Code |
| | EAN 128 |
| | EAN 8/13 |
| | GS1 Databar |
| | GS1 Databar Omnidirectional |
| | GS1 Databar QR code |
| | GS1 Databar Stacked |
| | PDF417 |
| | Pharma Code |
| | QR code |
| | UPC |

Optical data

| | |
|-------------------------------|-----------------|
| Reading distance | 50 ... 220 mm |
| Light source | LED, Infrared |
| Transmitted-signal shape | Pulsed |
| Camera resolution, horizontal | 1,280 px |
| Camera resolution, vertical | 960 px |
| Modulus size | 0.19 ... 0.5 mm |
| Electronic shutter speed | 0.068 ... 5 ms |
| Camera type | Monochrome |

Electrical data

| | |
|--------------------|------------------------------|
| Protective circuit | Polarity reversal protection |
| | Short circuit protected |

Performance data

| | |
|---------------------------|-----------------|
| Supply voltage U_B | 18 ... 30 V, DC |
| Average power consumption | 8 W |

Inputs

| | |
|------------------------------------|------------|
| Number of digital switching inputs | 1 Piece(s) |
|------------------------------------|------------|

Switching inputs

| | |
|--------------|----|
| Voltage type | DC |
|--------------|----|

Outputs

| | |
|-------------------------------------|------------|
| Number of digital switching outputs | 1 Piece(s) |
|-------------------------------------|------------|

Switching outputs

| | |
|-------------------------|--------|
| Voltage type | DC |
| Switching current, max. | 100 mA |

Switching output 1

| | |
|---------------------|----------------------|
| Switching element | MOSFET semiconductor |
| Switching principle | +24 V switching |

Inputs/outputs selectable

| | |
|-------------------------------------|------------|
| Number of inputs/outputs selectable | 2 Piece(s) |
| Voltage type, outputs | DC |
| Voltage type, inputs | DC |

Interface

| | |
|------|--------------------------|
| Type | RS 232, RS 422, Ethernet |
|------|--------------------------|

RS 232

| | |
|-----------------------|----------------------|
| Function | Process |
| Transmission speed | 4,800 ... 115,200 Bd |
| Data format | Adjustable |
| Start bit | 1 |
| Data bit | 8 |
| Stop bit | 1 |
| Parity | None |
| Transmission protocol | <STX><data><CR><LF> |
| Data encoding | ASCII |
| | Binary |

RS 422

| | |
|--------------------|----------------------|
| Function | Process |
| Transmission speed | 4,800 ... 115,200 Bd |
| Data format | Adjustable |
| Start bit | 1 |
| Data bit | 7, 8 data bits |
| Stop bit | 1, 2 stop bits |
| Parity | Adjustable |
| Data encoding | ASCII |
| | Binary |

Ethernet

| | |
|-----------------------|---------------------------|
| Architecture | Client |
| | Server |
| Address assignment | DHCP |
| | Manual address assignment |
| Transmission speed | 10 Mbit/s |
| | 100 Mbit/s |
| Function | Process |
| Switch functionality | None |
| Transmission protocol | TCP/IP, UDP |

Service interface

| | |
|------|----------|
| Type | Ethernet |
|------|----------|

Ethernet

| | |
|----------|---------|
| Function | Service |
|----------|---------|

Connection

| | |
|-----------------------|------------|
| Number of connections | 2 Piece(s) |
|-----------------------|------------|

Technical data

Connection 1

| | |
|---------------------------|----------------|
| Function | Data interface |
| | Signal IN |
| | Signal OUT |
| | Voltage supply |
| Type of connection | Connector |
| Thread size | M12 |
| Type | Male |
| Material | Metal |
| No. of pins | 12 -pin |
| Encoding | A-coded |

Connection 2

| | |
|---------------------------|-------------------------|
| Function | Configuration interface |
| | Data interface |
| Type of connection | Connector |
| Thread size | M12 |
| Type | Female |
| Material | Metal |
| No. of pins | 4 -pin |
| Encoding | D-coded |

Mechanical data

| | |
|------------------------------|------------------------------|
| Design | Cubic |
| Dimension (W x H x L) | 43 mm x 61 mm x 44 mm |
| Housing material | Metal |
| | Plastic |
| Metal housing | Diecast aluminum |
| Plastic housing | PC |
| Lens cover material | Glass |
| Net weight | 120 g |
| Housing color | Silver |
| Type of fastening | Mounting thread |
| | Via optional mounting device |

Operation and display

| | |
|--|---------------------|
| Type of display | LED |
| Number of LEDs | 10 Piece(s) |
| Type of configuration | Configuration codes |
| | Teach-in |
| | Via web browser |
| Operational controls | Button(s) |
| Function of the operational control | Adjustment mode |
| | Auto-setup |
| | Trigger |

Environmental data

| | |
|---|---------------|
| Ambient temperature, operation | 0 ... 50 °C |
| Ambient temperature, storage | -20 ... 70 °C |
| Relative humidity (non-condensing) | 90 % |

Certifications

| | |
|--|-------------------------|
| Degree of protection | IP 65 |
| Protection class | III |
| Certifications | c UL US |
| Test procedure for EMC in accordance with standard | EN 61000-6-2 |
| | EN 61000-6-4 |
| Test procedure for continuous shock in accordance with standard | IEC 60068-2-29, test Eb |
| Test procedure for vibration in accordance with standard | IEC 60068-2-6, test Fc |

Classification

| | |
|------------------------------|----------|
| Customs tariff number | 84719000 |
| eCl@ss 5.1.4 | 27280103 |
| eCl@ss 8.0 | 27280103 |
| eCl@ss 9.0 | 27280103 |
| eCl@ss 10.0 | 27280103 |
| eCl@ss 11.0 | 27280103 |
| ETIM 5.0 | EC002550 |
| ETIM 6.0 | EC002999 |
| ETIM 7.0 | EC002999 |

Dimensioned drawings

All dimensions in millimeters

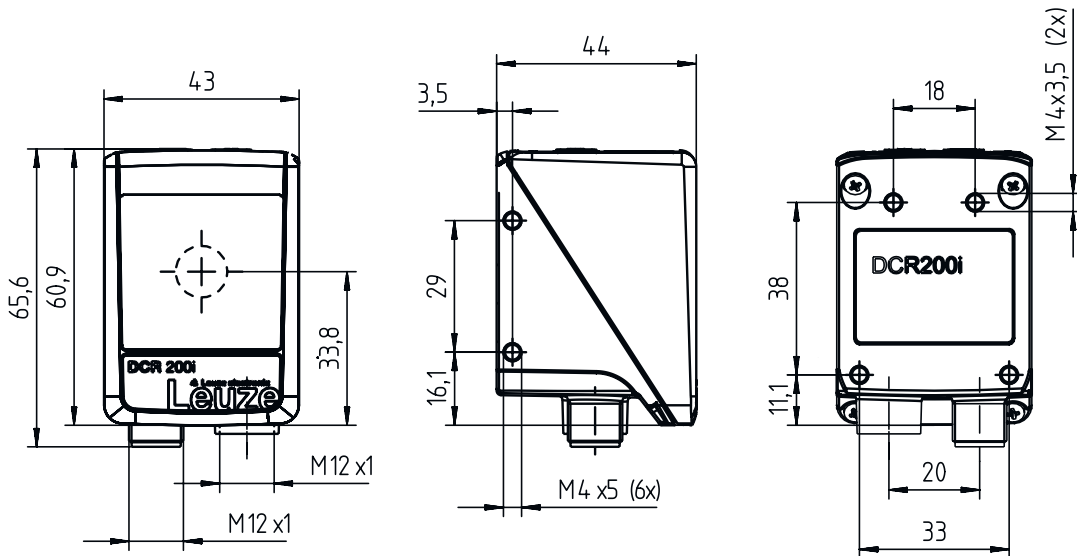

Electrical connection

Connection 1

PWR / SWIO

| | |
|---------------------------|----------------|
| Function | Data interface |
| | Signal IN |
| | Signal OUT |
| | Voltage supply |
| Type of connection | Connector |
| Thread size | M12 |
| Type | Male |
| Material | Metal |
| No. of pins | 12 -pin |
| Encoding | A-coded |

Pin Pin assignment

| Pin | Pin assignment |
|-----|-------------------------|
| 1 | VIN |
| 2 | GNDIN |
| 3 | SWIN 1 |
| 4 | SWOUT 2 |
| 5 | FE |
| 6 | GND RS 232 / GND RS 422 |
| 7 | Rx- |
| 8 | Tx- |
| 9 | RxD/Rx+ |
| 10 | TxD/Tx+ |
| 11 | SWIO 3 |
| 12 | SWIO 4 |

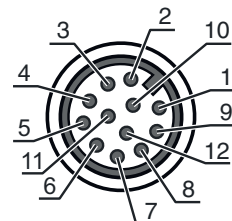

Electrical connection

| Connection 2 | HOST |
|--------------------|---|
| Function | Configuration interface Data interface |
| Type of connection | Connector |
| Thread size | M12 |
| Type | Female |
| Material | Metal |
| No. of pins | 4 -pin |
| Encoding | D-coded |

| Pin | Pin assignment |
|-----|----------------|
| 1 | TD+ |
| 2 | RD+ |
| 3 | TD- |
| 4 | RD- |

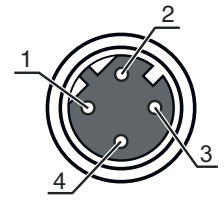

Diagrams

Reading distances

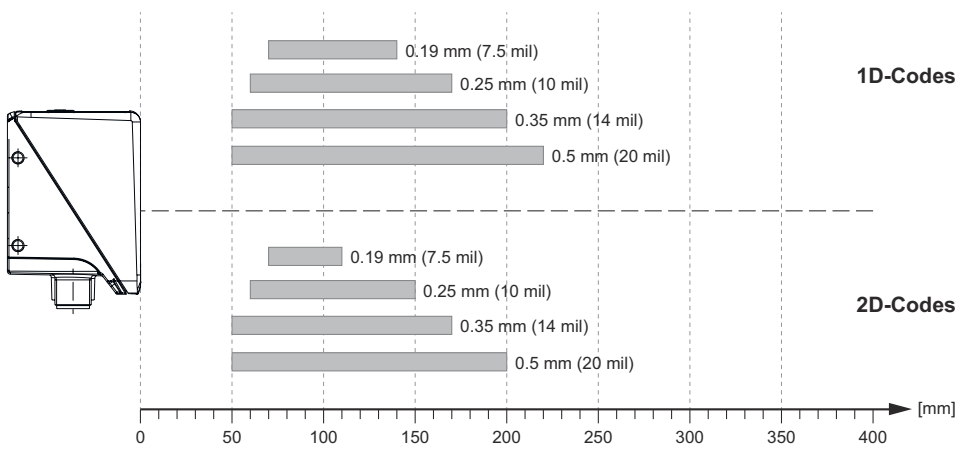

Relationship between camera distance and reading field size



Diagrams



Operation and display

| LED | Display | Meaning |
|---------|-------------------------------------|--|
| 1 PWR | Off | No supply voltage |
| | Green, flashing | Initialization |
| | Green, continuous light | Operational readiness |
| | Orange, continuous light | Service operation |
| | Red, flashing | Device OK, warning set |
| | Red, continuous light | Device error |
| 2 NET | Off | No supply voltage |
| | Green, flashing | Initialization |
| | Green, continuous light | Operational readiness |
| | Red, flashing | Communication error |
| 3 LINK | Red, continuous light | Network error |
| | Green, continuous light | Ethernet connection is established |
| 4 TRIG | Yellow, flashing | Data exchange active |
| | Green, flashing | Trigger and display of the read quality |
| 5 AUTO | Green, flashing | Auto-setup and display of the read quality |
| 6 ADJ | Green, flashing | Alignment mode and display of the read quality |
| 7 TEACH | Green, flashing | Teach-in and display of the read quality |
| 8 | Green, flashing | Display of the read quality |
| 9 | Green, flashing | Display of the read quality |
| 10 | Green, flashing (behind lens cover) | Reading successful |

Part number code

Part designation: DCR XXX YYY-Z-AAA-BC-D-EEEE

| | |
|------|--|
| DCR | Operating principle DCR: Dual Code Reader |
| XXXX | Series/interface (integrated fieldbus technology) 202i: Ethernet TCP/IP, UDP, RS 232/RS 422 248i: PROFINET-IO, Ethernet TCP/IP, UDP, RS 232/RS 422 202iC: Ethernet TCP/IP, UDP, RS 232/RS 422 (IoT / Industry 4.0 connectivity) 248iC: PROFINET-IO, Ethernet TCP/IP, UDP, RS 232/RS 422 (IoT / Industry 4.0 connectivity) |

Part number code

| | |
|-------------|--|
| YYY | Equipment FIX: Fixed focal length |
| Z | Optics U: Ultra high density (very close) N: High Density (close) M: Medium Density (medium distance) F: Low Density (remote) L: Ultra low density (very large distance) |
| AAA | Beam exit 102: front |
| B | Illumination R: Red light I: infrared light |
| C | Resolution range 3: 1280 x 960 pixels |
| D | Protective screen n/a: plastic G: Glass P: Polarization filter |
| EEEE | Special equipment V: Stainless steel housing F001: NPN inputs/outputs F099: OPC-UA function H: with heating Xxxx: customer-specific model |

Note



A list with all available device types can be found on the Leuze website at www.leuze.com.

Notes



Observe intended use!



- ⌘ This product is not a safety sensor and is not intended as personnel protection.
- ⌘ The product may only be put into operation by competent persons.
- ⌘ Only use the product in accordance with its intended use.

Accessories

Connection technology - Connection cables

| | Part no. | Designation | Article | Description |
|--|----------|--------------------|------------------|---|
|  | 50130281 | KD S-M12-CA-P1-020 | Connection cable | Connection 1: Connector, M12, Axial, Female, A-coded, 12 -pin Connection 2: Open end Shielded: Yes Cable length: 2,000 mm Sheathing material: PUR |

Accessories

| | Part no. | Designation | Article | Description |
|---|----------|---------------------|------------------|--|
|  | 50135073 | KS ET-M12-4A-P7-020 | Connection cable | Suitable for interface: Ethernet Connection 1: Connector, M12, Axial, Male, D-coded, 4 -pin Connection 2: Open end Shielded: Yes Cable length: 2,000 mm Sheathing material: PUR |

Connection technology - Interconnection cables

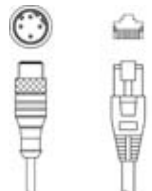
| | Part no. | Designation | Article | Description |
|--|----------|-----------------------------|-----------------------|--|
|  | 50135080 | KSS ET-M12-4A-RJ45-A-P7-020 | Interconnection cable | Suitable for interface: Ethernet Connection 1: Connector, M12, Axial, Male, D-coded, 4 -pin Connection 2: RJ45 Shielded: Yes Cable length: 2,000 mm Sheathing material: PUR |

Mounting technology - Mounting brackets

| | Part no. | Designation | Article | Description |
|---|----------|-------------|------------------|--|
|  | 50132151 | BT 320M | Mounting bracket | Design of mounting device: Angle, L-shape Fastening, at system: Through-hole mounting Mounting bracket, at device: Screw type Type of mounting device: Rigid Material: Metal |

Mounting technology - Rod mounts

| | Part no. | Designation | Article | Description |
|---|----------|--------------|-----------------|--|
|  | 50132150 | BTU 320M-D12 | Mounting system | Design of mounting device: Mounting system Fastening, at system: For 12 mm rod Mounting bracket, at device: Screw type Type of mounting device: Clampable, Adjustable, Turning, 360° Material: Metal |

General

| | Part no. | Designation | Article | Description |
|--|----------|------------------------|--------------|--|
|  | 50144030 | IL AL 034/031 IR 110 H | Illumination | Special version: Heating Functions: Strobed operation (edge-triggered), no continuous operation |

Accessories

Services

| | Part no. | Designation | Article | Description |
|--|----------|-------------|------------------|--|
|  | S981014 | CS30-S-110 | Start-up support | <p>Details: Performed at location of customer's choosing, duration: max. 10 hours.</p> <p>Conditions: Devices and connection cables are already mounted, price not including travel costs and, if applicable, accommodation expenses.</p> <p>Restrictions: No mechanical (mounting) and electrical (wiring) work performed, no changes (attachments, wiring, programming) to third-party components in the nearby environment.</p> |
|  | S981019 | CS30-T-110 | Product training | <p>Details: Location and content to be agreed upon, duration: max. 10 hours.</p> <p>Conditions: Price not including travel costs and, if applicable, accommodation expenses.</p> <p>Restrictions: Travel costs and accommodation expenses charged separately and according to expenditure.</p> |

Note



A list with all available accessories can be found on the Leuze website in the Download tab of the article detailed page.