

Technical data sheet

Throughbeam photoelectric sensor

Part no.: 50127443

LE49C.UC1/M4-TB



Figure can vary

Contents

- Technical data
- Dimensioned drawings
- Electrical connection
- Circuit diagrams
- Diagrams
- Operation and display
- Suitable transmitters
- Part number code
- Notes
- Further information
- Accessories



Technical data

Basic data

Series	49C
Operating principle	Throughbeam principle
Device type	Receiver

Optical data

Operating range	Guaranteed operating range
Operating range	0 ... 120 m
Operating range limit	Typical operating range
Operating range limit	0.5 ... 150 m

Electrical data

Protective circuit	Polarity reversal protection
	Short circuit protected
	Transient protection

Performance data

Supply voltage U_B	20 ... 250 V, AC/DC
Power consumption (with AC)	1.5 V·A

Outputs

Number of digital switching outputs	1 Piece(s)
-------------------------------------	------------

Switching outputs

Voltage type	AC/DC
Switching current, max.	400 mA
Switching power	100 V·A
Switching voltage	250 V AC/DC

Switching output 1

Assignment	Connection 1, pin 4
Switching element	MOSFET semiconductor, NO (normally open)
Switching principle	Light/dark reversible

Timing

Switching frequency	150 Hz
Response time	3.3 ms
Readiness delay	300 ms

Connection

Connection 1

Function	Signal OUT
	Voltage supply
Type of connection	Terminal
Type of terminal	Spring-cage terminal
No. of pins	5 -pin

Mechanical data

Dimension (W x H x L)	31 mm x 104 mm x 55.5 mm
Housing material	Plastic
Plastic housing	PC
Lens cover material	Plastic
Net weight	150 g
Housing color	Red
Type of fastening	Through-hole mounting Via optional mounting device

Operation and display

Type of display	LED
Number of LEDs	3 Piece(s)
Operational controls	270° potentiometer
	Teach button
Function of the operational control	Activation of the time module for dropout delay
	Light/dark switching
	Sensitivity adjustment

Environmental data

Ambient temperature, operation	-40 ... 60 °C
Ambient temperature, storage	-40 ... 70 °C

Certifications

Degree of protection	IP 67
Protection class	II
Certifications	c UL US
Standards applied	IEC 60947-5-2

Classification

Customs tariff number	85365080
eCl@ss 5.1.4	27270901
eCl@ss 8.0	27270901
eCl@ss 9.0	27270901
eCl@ss 10.0	27270901
eCl@ss 11.0	27270901
ETIM 5.0	EC002716
ETIM 6.0	EC002716
ETIM 7.0	EC002716

Dimensioned drawings

All dimensions in millimeters

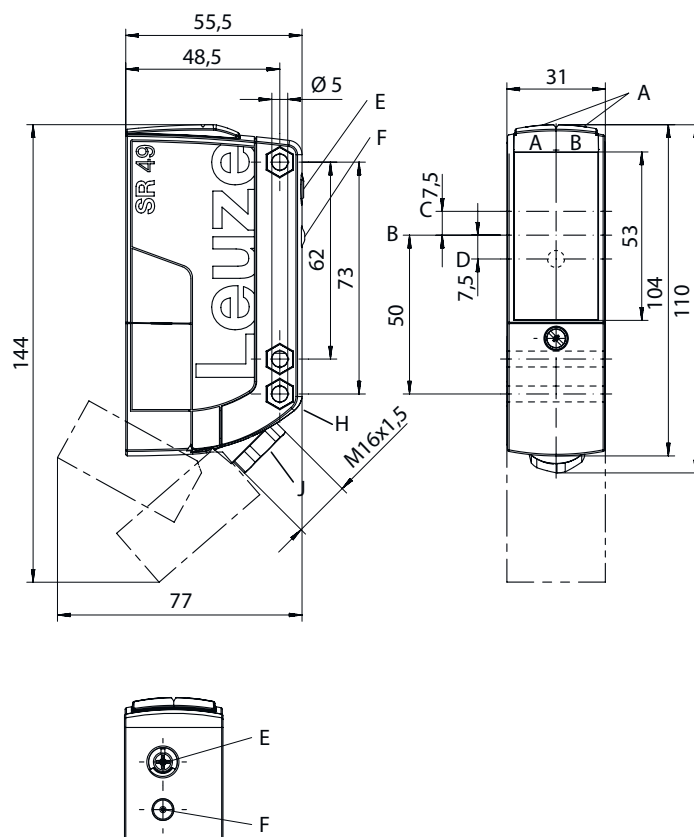

- | | | |
|----------------|---|---|
| AA Green LED | D Yellow LED | J Cable entry with M16x 1.5 screw fitting for Ø 5 ... 10 mm |
| AB Yellow LED | E Sensitivity adjustment | |
| B Optical axis | F Teach button | |
| C Receiver | G Countersinking for SK nut M5, 4.2 mm deep | |

Electrical connection

Connection 1

Function	Signal OUT
	Voltage supply
Type of connection	Terminal
Type of terminal	Spring-cage terminal
No. of pins	5-pin

Pin Pin assignment

	1
1	+ / L1
	2
2	- / N
	3
3	n.c.
	4
4	OUT 1
	5
5	COM

Circuit diagrams

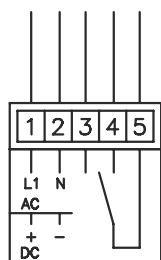

Diagrams

Typ. response behavior

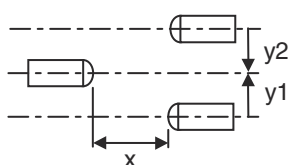
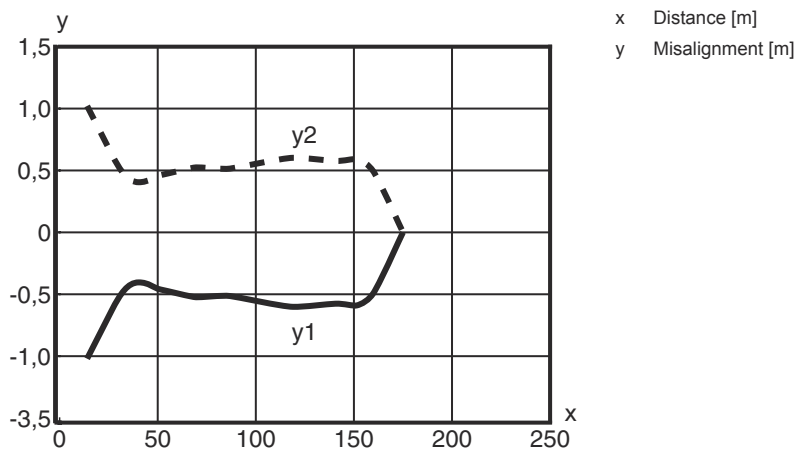

Operation and display

LED	Display	Meaning
1	Green, continuous light	Operational readiness
2	Yellow, continuous light	Light path free
	Yellow, flashing	Light path free, no function reserve
3	Yellow, continuous light (behind lens cover)	Light path free
	Yellow, flashing (behind lens cover)	Light path free, minimum function reserve

Suitable transmitters

	Part no.	Designation	Article	Description
	50127437	LS49C.UC-TB	Throughbeam photoelectric sensor transmitter	Operating range limit: 0 ... 150 m Light source: LED, Red Supply voltage: AC/DC Connection: Terminal, 2 -pin

Part number code

Part designation: **AAA49Cd.EEfG/iJ-KL**

AAA49C	Operating principle / construction PRK49C: retro-reflective photoelectric sensor with polarization filter HT49C: diffuse reflection sensor with background suppression LS49C: throughbeam photoelectric sensor transmitter LE49C: throughbeam photoelectric sensor receiver
d	Light type n/a: red light l: infrared light
EE	Operating voltage n/a: 10 ... 30 V, DC UC: 20 ... 250V AC/DC (all-mains design)
f	Equipment H: with heating D: depolarizing media 1: 270° potentiometer 8: activation input (activation with high signal)
iJ	Switching output / Function / OUT1/OUT2 2: NPN transistor output, light switching N: NPN transistor output, dark switching 4: PNP transistor output, light switching P: PNP transistor output, dark switching W: warning output TS: Relay, NC contact/NO contact M4: Low impedance MOSFET semiconductor switching output, NO contact
KL	Electrical connection TB: Terminal block - terminal compartment with spring terminals (5 x 1.5mm ²) n/a: cable, standard length 2000 mm

Note



A list with all available device types can be found on the Leuze website at www.leuze.com.

Notes



Observe intended use!



- ⚠ This product is not a safety sensor and is not intended as personnel protection.
- ⚠ The product may only be put into operation by competent persons.
- ⚠ Only use the product in accordance with its intended use.

Further information

- All-insulated, rating voltage 250 VAC
- With inductive or capacitive load, provide suitable spark extinction (snubber)

Accessories

Mounting technology - Mounting brackets

	Part no.	Designation	Article	Description
	50025570	BT 96	Mounting device	Design of mounting device: Angle, L-shape Fastening, at system: Through-hole mounting Mounting bracket, at device: Screw type Type of mounting device: Rigid Material: Metal

Mounting technology - Rod mounts

	Part no.	Designation	Article	Description
	50128380	BTU 460M-D12	Mounting system	Design of mounting device: Mounting system Fastening, at system: For 12 mm rod Mounting bracket, at device: Screw type Type of mounting device: Adjustable, Turning, 360° Material: Metal

Note



A list with all available accessories can be found on the Leuze website in the Download tab of the article detailed page.