

Technical data sheet

Throughbeam photoelectric sensor

Part no.: 50132822

LS318BI/9D

Contents

- Technical data
- Dimensioned drawings
- Electrical connection
- Diagrams
- Operation and display
- Suitable receivers
- Part number code
- Notes
- Further information
- Accessories



Figure can vary



Technical data

Basic data

Series	318B
Operating principle	Throughbeam principle
Device type	Transmitter

Special version

Special version	Deactivation input
-----------------	--------------------

Optical data

Operating range	Guaranteed operating range
Operating range	0 ... 16 m
Operating range limit	Typical operating range
Operating range limit	0 ... 23 m
Light source	LED, Infrared
LED light wavelength	850 nm
LED group	Exempt group (in acc. with EN 62471)
Transmitted-signal shape	Pulsed

Electrical data

Protective circuit	Polarity reversal protection Short circuit protected
--------------------	---

Performance data

Supply voltage U_B	10 ... 30 V, DC, Incl. residual ripple
Residual ripple	0 ... 15 %, From U_B
Open-circuit current	0 ... 15 mA

Inputs

Number of deactivation inputs	2 Piece(s)
-------------------------------	------------

Deactivation inputs

Deactivation input 1 Active switching state

Low

Deactivation input 2 Active switching state

High

Outputs

Switching outputs

Switching voltage	high: $\geq(U_B - 2V)$ Low: $\leq 2V$
-------------------	--

Switching output 1 Switching element

Transistor

Function Deactivation input (deactivation with high signal)

Switching output 2 Switching element

Transistor

Function Deactivation input (deactivation with low signal)

Timing

Readiness delay	300 ms
-----------------	--------

Connection

Connection 1

Function	Signal IN Voltage supply
Type of connection	Cable
Cable length	2,000 mm
Sheathing material	PUR
Cable color	Black
Number of conductors	4 -wire
Wire cross section	0.2 mm ²

Mechanical data

Thread size	M18 x 1 mm
Dimension (\varnothing x L)	18 mm x 46 mm
Housing material	Plastic
Plastic housing	ABS
Lens cover material	Plastic
Net weight	70 g
Housing color	Black Red

Operation and display

Type of display	LED
Number of LEDs	1 Piece(s)

Environmental data

Ambient temperature, operation	-40 ... 50 °C
Ambient temperature, storage	-40 ... 70 °C

Certifications

Degree of protection	IP 67
Protection class	III
Certifications	c UL US
Standards applied	IEC 60947-5-2

Classification

Customs tariff number	85365019
eCl@ss 5.1.4	27270901
eCl@ss 8.0	27270901
eCl@ss 9.0	27270901
eCl@ss 10.0	27270901
eCl@ss 11.0	27270901
ETIM 5.0	EC002716
ETIM 6.0	EC002716
ETIM 7.0	EC002716

Dimensioned drawings

All dimensions in millimeters

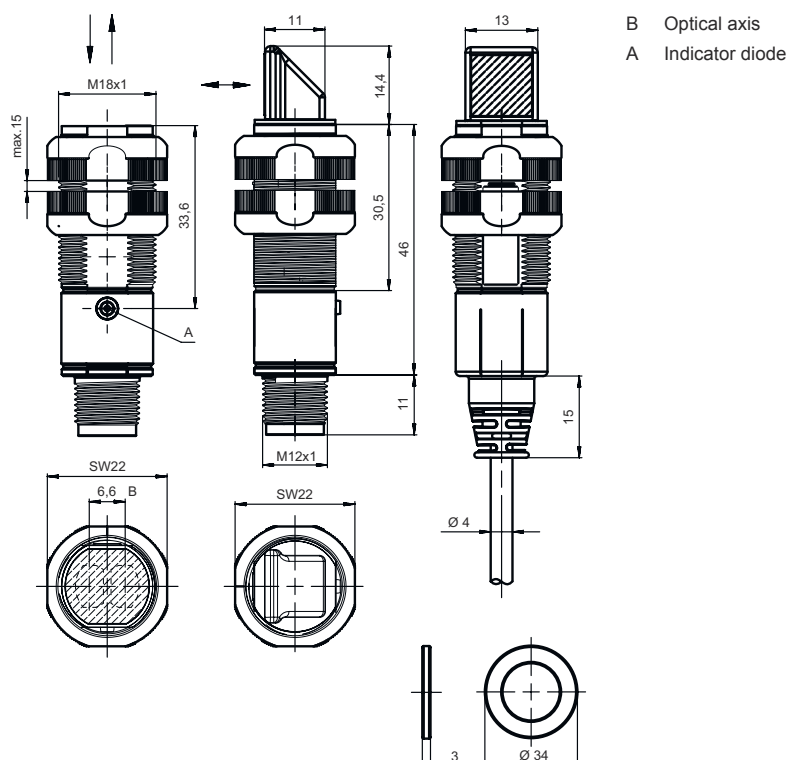

Electrical connection

Connection 1

Function	Signal IN Voltage supply
Type of connection	Cable
Cable length	2,000 mm
Sheathing material	PUR
Cable color	Black
Number of conductors	4 -wire
Wire cross section	0.2 mm ²

Conductor color

Conductor assignment

Brown	V+
White	IN 2
Blue	GND
Black	IN 1

Diagrams

Typ. response behavior

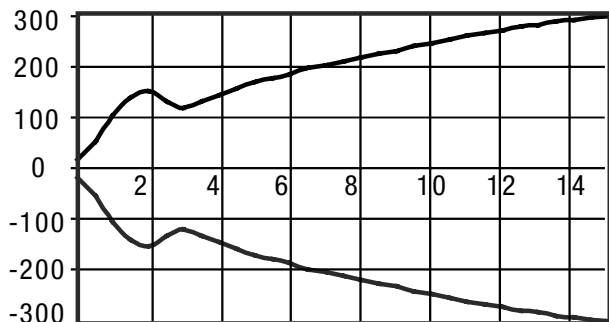

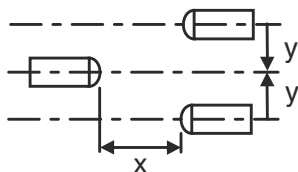

x Distance [m]
y Misalignment [mm]



Operation and display

LED	Display	Meaning
1	Green, continuous light	Operational readiness
	Yellow, continuous light	Transmitted beam active

Suitable receivers

	Part no.	Designation	Article	Description
	50116844	LE318B/2N	Throughbeam photoelectric sensor receiver	Operating range limit: 0 ... 15 m Supply voltage: DC Digital switching outputs: 2 Piece(s) Switching output 1: Transistor, NPN, Light switching Switching output 2: Transistor, NPN, Dark switching Switching frequency: 500 Hz Connection: Cable, 2,000 mm, 4 -wire
	50116846	LE318B/4P	Throughbeam photoelectric sensor receiver	Operating range limit: 0 ... 15 m Supply voltage: DC Digital switching outputs: 2 Piece(s) Switching output 1: Transistor, PNP, Light switching Switching output 2: Transistor, PNP, Dark switching Switching frequency: 500 Hz Connection: Cable, 2,000 mm, 4 -wire

Part number code

Part designation: **XXX318BY-AAAF.BB/CC-DDD**

XXX318B	<p>Operating principle</p> <p>PRK: retro-reflective photoelectric sensor with polarization filter</p> <p>ET: energetic diffuse reflection sensor</p> <p>FT: diffuse reflection sensor with fading</p> <p>LE: throughbeam photoelectric sensor receiver</p> <p>LS: throughbeam photoelectric sensor transmitter</p>
Y	<p>Light type</p> <p>n/a: red light</p> <p>I: infrared light</p>

Part number code

AAAF	Preset range (optional) n/a: operating range acc. to data sheet xxxF: preset range [mm]
BB	Equipment n/a: axial optics W: 90° angular optics 3: teach-in via button X: reinforced fading
CC	Switching output / function (OUT1 = pin 4, OUT2 = pin 2): 4: PNP transistor output, light switching P: PNP transistor output, dark switching 2: NPN transistor output, light switching N: NPN transistor output, dark switching 9: input for transmitter deactivation (deactivation with HIGH signal) D: input for transmitter deactivation (deactivation with LOW signal) X: pin not used
DDD	Electrical connection n/a: cable, standard length 2000 mm, 4-wire M12: M12 connector, 4-pin (plug) 5000: cable, standard length 5000 mm, 4-wire 200-M12: cable, length 200 mm with M12 connector, 4-pin, axial (plug)

Note



A list with all available device types can be found on the Leuze website at www.leuze.com.

Notes



Observe intended use!



- ⌘ This product is not a safety sensor and is not intended as personnel protection.
- ⌘ The product may only be put into operation by competent persons.
- ⌘ Only use the product in accordance with its intended use.

For UL applications:



- ⌘ For UL applications, use is only permitted in Class 2 circuits in accordance with the NEC (National Electric Code).
- ⌘ These proximity switches shall be used with UL Listed Cable assemblies rated 30V, 0.5A min, in the field installation, or equivalent (categories: CYJV/ CYJV7 or PVVA/PVVA7)

Further information

- Sum of the output currents for both outputs, 50 mA for ambient temperatures > 40 °C

Accessories

Mounting technology - Mounting brackets

	Part no.	Designation	Article	Description
	50113548	BT D18M.5	Mounting bracket	Diameter, inner: 18 mm Design of mounting device: Angle, L-shape Fastening, at system: Through-hole mounting Mounting bracket, at device: Screw type Type of mounting device: Rigid Material: Stainless steel

Mounting technology - Rod mounts

	Part no.	Designation	Article	Description
	50117490	BTU D18M-D12	Mounting system	Design of mounting device: Mounting system Fastening, at system: Through-hole mounting Mounting bracket, at device: Screw type Type of mounting device: Clampable, Adjustable, Turning, 360° Material: Metal

Note



A list with all available accessories can be found on the Leuze website in the Download tab of the article detailed page.