

## Technical data sheet

### Polarized retro-reflective photoelectric

Part no.: 50133731

PRK3CL1.BTT3/LP



#### Contents

- Technical data
- Dimensioned drawings
- Electrical connection
- Operation and display
- Reflectors & reflective tapes
- Part number code
- Notes
- Further information
- Accessories



## Technical data

### Basic data

|                     |   |
|---------------------|---|
| Series              | 3C  |
| Operating principle | Reflection principle  |
| Application         | Detection of highly transparent bottles<br>Detection of transparent films |

### Special version

|                 |                                      |
|-----------------|--------------------------------------|
| Special version | Autocollimation<br>Tracking function |
|-----------------|--------------------------------------|

### Optical data

|                                      |                            |
|--------------------------------------|----------------------------|
| Operating range                      | Guaranteed operating range |
| Operating range                      | 0 ... 0.4 m                |
| Operating range limit                | Typical operating range    |
| Operating range limit                | 0 ... 0.5 m                |
| Beam path                            | Collimated                 |
| Light source                         | Laser, Red                 |
| Laser light wavelength               | 655 nm                     |
| Laser class                          | 1, IEC/EN 60825-1:2007     |
| Max. laser power                     | 0.0017 W                   |
| Transmitted-signal shape             | Pulsed                     |
| Pulse duration                       | 5.3 µs                     |
| Light spot size [at sensor distance] | 1 mm [500 mm]              |
| Type of light spot geometry          | Round                      |
| Shift angle                          | Typ. ± 2°                  |

### Electrical data

|                    |   |
|--------------------|---|
| Protective circuit | Polarity reversal protection<br>Short circuit protected |
|--------------------|---|

### Performance data

|                      |  |
|----------------------|--|
| Supply voltage $U_B$ | 10 ... 30 V, DC, Incl. residual ripple |
| Residual ripple      | 0 ... 15 %, From $U_B$                 |
| Open-circuit current | 0 ... 15 mA                            |

### Outputs

|                                     |            |
|-------------------------------------|------------|
| Number of digital switching outputs | 2 Piece(s) |
|-------------------------------------|------------|

### Switching outputs

|                         |  |
|-------------------------|--|
| Voltage type            | DC                                       |
| Switching current, max. | 100 mA                                   |
| Switching voltage       | high: $\geq(U_B - 2V)$<br>Low: $\leq 2V$ |

### Switching output 1

|                     |  |
|---------------------|--|
| Switching element   | Transistor, Push-pull                                |
| Switching principle | IO-Link / light switching (PNP)/dark switching (NPN) |

### Switching output 2

|                     |                 |
|---------------------|-----------------|
| Switching element   | Transistor, PNP |
| Switching principle | Dark switching  |

### Timing

|                     |          |
|---------------------|----------|
| Switching frequency | 3,000 Hz |
| Response time       | 0.17 ms  |
| Readiness delay     | 300 ms   |

### Interface

|      |         |
|------|---------|
| Type | IO-Link |
|------|---------|

### IO-Link

|                  |               |
|------------------|---------------|
| COM mode         | COM2          |
| Frame type       | 2.5           |
| Specification    | V1.1          |
| SIO-mode support | Yes           |
| Min. cycle time  | COM2 = 2.3 ms |

### Connection

#### Connection 1

|                      |   |
|----------------------|---|
| Function             | Signal IN<br>Signal OUT<br>Voltage supply |
| Type of connection   | Cable                                     |
| Cable length         | 2,000 mm                                  |
| Sheathing material   | PUR                                       |
| Cable color          | Black                                     |
| Number of conductors | 4 -wire                                   |
| Wire cross section   | 0.2 mm <sup>2</sup>                       |

### Mechanical data

|                            |   |
|----------------------------|---|
| Dimension (W x H x L)      | 11.4 mm x 34.2 mm x 18.3 mm                             |
| Housing material           | Plastic   |
| Plastic housing            | PC-ABS  |
| Lens cover material        | Plastic / PMMA  |
| Net weight                 | 50 g  |
| Housing color              | Red   |
| Type of fastening          | Two M3 threaded sleeves<br>Via optional mounting device |
| Compatibility of materials | ECOLAB  |

### Operation and display

|                                     |                        |
|-------------------------------------|------------------------|
| Type of display                     | LED                    |
| Number of LEDs                      | 2 Piece(s)             |
| Operational controls                | Teach button           |
| Function of the operational control | Sensitivity adjustment |

### Environmental data

|                                |               |
|--------------------------------|---------------|
| Ambient temperature, operation | -10 ... 55 °C |
| Ambient temperature, storage   | -40 ... 70 °C |

### Certifications

|                      |                 |
|----------------------|-----------------|
| Degree of protection | IP 67<br>IP 69K |
| Protection class     | III             |
| Certifications       | c UL US         |
| Standards applied    | IEC 60947-5-2   |

### Classification

|                       |          |
|-----------------------|----------|
| Customs tariff number | 85365019 |
| eCl@ss 5.1.4          | 27270902 |
| eCl@ss 8.0            | 27270902 |
| eCl@ss 9.0            | 27270902 |
| eCl@ss 10.0           | 27270902 |
| eCl@ss 11.0           | 27270902 |
| ETIM 5.0              | EC002717 |
| ETIM 6.0              | EC002717 |
| ETIM 7.0              | EC002717 |

# Dimensioned drawings

All dimensions in millimeters

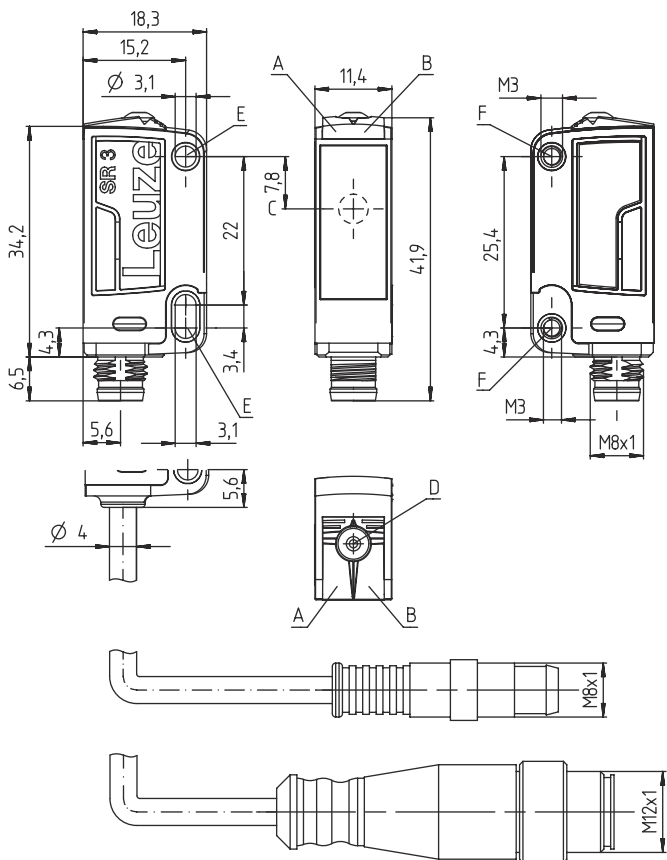

- A Green LED
- B Yellow LED
- C Optical axis
- D Teach button
- E Mounting sleeve (standard)
- F Threaded sleeve (3C.B series)

## Electrical connection

### Connection 1

|                      |   |
|----------------------|---|
| Function             | Signal IN<br>Signal OUT<br>Voltage supply |
| Type of connection   | Cable                                     |
| Cable length         | 2,000 mm                                  |
| Sheathing material   | PUR                                       |
| Cable color          | Black                                     |
| Number of conductors | 4 -wire                                   |
| Wire cross section   | 0.2 mm <sup>2</sup>                       |

### Conductor color

### Conductor assignment

|       |                 |
|-------|-----------------|
| Brown | V+              |
| White | OUT 2           |
| Blue  | GND             |
| Black | IO-Link / OUT 1 |



## Operation and display

| LED | Display                 | Meaning               |
|-----|-------------------------|-----------------------|
| 1   | Green, continuous light | Operational readiness |

## Operation and display

| LED | Display                  | Meaning                              |
|-----|--------------------------|--------------------------------------|
| 2   | Yellow, continuous light | Light path free                      |
|     | Yellow, flashing         | Light path free, no function reserve |

## Reflectors & reflective tapes

|  | Part no. | Designation   | Operating range<br>Operating range | Description   |
|--|----------|---------------|------------------------------------|---|
|   | 50110191 | REF 6-A-25x25 | 0 ... 0.4 m<br>0 ... 0.5 m         | Design: Rectangular<br>Reflective surface: 25 mm x 25 mm<br>Triple reflector size: 0.3 mm<br>Material: Plastic<br>Chemical designation of the material: PMMA<br>Fastening: Self-adhesive  |
|   | 50114185 | REF 6-S-20x40 | 0 ... 0.4 m<br>0 ... 0.5 m         | Design: Rectangular<br>Reflective surface: 16 mm x 38 mm<br>Triple reflector size: 0.3 mm<br>Material: Plastic<br>Base material: Plastic<br>Chemical designation of the material: PMMA8N<br>Fastening: Screw type                   |
|  | 50112142 | TK BR 53      | 0 ... 0.4 m<br>0 ... 0.5 m         | Design: Rectangular<br>Reflective surface: 29 mm x 10 mm<br>Triple reflector size: 0.3 mm<br>Material: Plastic<br>Base material: Stainless steel<br>Chemical designation of the material: Stainless steel<br>Fastening: Housing fit |

## Part number code

Part designation: AAA 3C d EE-f.GG H/i J-K

|              |   |
|--------------|---|
| <b>AAA3C</b> | <b>Operating principle / construction</b><br>HT3C: diffuse reflection sensor with background suppression<br>LS3C: throughbeam photoelectric sensor transmitter<br>LE3C: throughbeam photoelectric sensor receiver<br>PRK3C: retro-reflective photoelectric sensor with polarization filter  |
| <b>d</b>     | <b>Light type</b><br>n/a: red light<br>l: infrared light  |
| <b>EE</b>    | <b>Light source</b><br>n/a: LED<br>L1: laser class 1<br>L2: laser class 2   |
| <b>f</b>     | <b>Preset range (optional)</b><br>n/a: operating range acc. to data sheet<br>xxxF: preset range [mm]  |
| <b>GG</b>    | <b>Equipment</b><br>n/a: standard<br>A: autocollimation principle (single lens) for positioning tasks<br>B: housing model with two M3 threaded sleeves, brass<br>F: permanently set range<br>L: long light spot<br>S: small light spot<br>T: autocollimation principle (single lens) for highly transparent bottles without tracking<br>TT: autocollimation principle (single lens) for highly transparent bottles with tracking<br>V: V-optics<br>XL: extra long light spot<br>X: extended model |

## Part number code

|          |  |
|----------|--|
| <b>H</b> | <b>Operating range adjustment</b><br>n/a with HT: range adjustable via 8-turn potentiometer<br>n/a with retro-reflective photoelectric sensors (PRK): operating range not adjustable<br>1: 270° potentiometer<br>3: teach-in via button<br>6: auto-teach   |
| <b>i</b> | <b>Switching output/function OUT 1/IN: Pin 4 or black conductor</b><br>2: NPN transistor output, light switching<br>N: NPN transistor output, dark switching<br>4: PNP transistor output, light switching<br>P: PNP transistor output, dark switching<br>6: push-pull switching output, PNP light switching, NPN dark switching<br>G: push-pull switching output, PNP dark switching, NPN light switching<br>L: IO-Link interface (SIO mode: PNP light switching, NPN dark switching)<br>8: activation input (activation with high signal)<br>X: pin not used<br>1: IO-Link / light switching (NPN) / dark switching (PNP) |
| <b>J</b> | <b>Switching output / function OUT 2/IN: pin 2 or white conductor</b><br>2: NPN transistor output, light switching<br>N: NPN transistor output, dark switching<br>4: PNP transistor output, light switching<br>P: PNP transistor output, dark switching<br>6: push-pull switching output, PNP light switching, NPN dark switching<br>G: push-pull switching output, PNP dark switching, NPN light switching<br>W: warning output<br>X: pin not used<br>8: activation input (activation with high signal)<br>9: deactivation input (deactivation with high signal)<br>T: teach-in via cable                                 |
| <b>K</b> | <b>Electrical connection</b><br>n/a: cable, standard length 2000 mm, 4-wire<br>5000: cable, standard length 5000 mm, 4-wire<br>M8: M8 connector, 4-pin (plug)<br>M8.3: M8 connector, 3-pin (plug)<br>200-M8: cable, length 200 mm with M8 connector, 4-pin, axial (plug)<br>200-M8.3: cable, length 200 mm with M8 connector, 3-pin, axial (plug)<br>200-M12: cable, length 200 mm with M12 connector, 4-pin, axial (plug)   |

### Note



A list with all available device types can be found on the Leuze website at [www.leuze.com](http://www.leuze.com).

## Notes



### Observe intended use!



- ⌘ This product is not a safety sensor and is not intended as personnel protection.
- ⌘ The product may only be put into operation by competent persons.
- ⌘ Only use the product in accordance with its intended use.

### For UL applications:



- ⌘ For UL applications, use is only permitted in Class 2 circuits in accordance with the NEC (National Electric Code).
- ⌘ These proximity switches shall be used with UL Listed Cable assemblies rated 30V, 0.5A min, in the field installation, or equivalent (categories: CYJV/ CYJV7 or PVVA/PVVA7)

## Notes

### WARNING! LASER RADIATION – CLASS 1 LASER PRODUCT



The device satisfies the requirements of IEC 60825-1:2007 (EN 60825-1:2007) safety regulations for a product of **laser class 1** as well as the **U.S. 21 CFR 1040.10 regulations with deviations corresponding to "Laser Notice No. 50" from June 24, 2007.**

- ☞ Observe the applicable statutory and local laser protection regulations.
- ☞ The device must not be tampered with and must not be changed in any way.  
There are no user-serviceable parts inside the device.  
Repairs must only be performed by Leuze electronic GmbH + Co. KG.

## Further information

- Light source: Average life expectancy 50,000 h at an ambient temperature of 25 °C
- Response time: For short decay times, an ohmic load of approx. 5kOhm is recommended
- Sum of the output currents for both outputs, 50 mA for ambient temperatures > 40 °C
- Permissible operating temperature range during IO-Link operation: -10 °C to +40 °C

## Accessories

### Mounting technology - Mounting brackets

|   | Part no. | Designation | Article         | Description  |
|---|----------|-------------|-----------------|--|
|  | 50060511 | BT 3        | Mounting device | Design of mounting device: Angle, L-shape<br>Fastening, at system: Through-hole mounting<br>Mounting bracket, at device: Screw type<br>Type of mounting device: Rigid<br>Material: Metal |

### Mounting technology - Rod mounts

|   | Part no. | Designation  | Article         | Description  |
|---|----------|--------------|-----------------|--|
|  | 50117255 | BTU 200M-D12 | Mounting system | Design of mounting device: Mounting system<br>Fastening, at system: For 12 mm rod, Sheet-metal mounting<br>Mounting bracket, at device: Screw type, Suited for M3 screws<br>Type of mounting device: Clampable, Adjustable, Turning, 360°<br>Material: Metal |

### Micro-triad-type reflectors

|   | Part no. | Designation   | Article   | Description   |
|---|----------|---------------|-----------|---|
|  | 50114185 | REF 6-S-20x40 | Reflector | Design: Rectangular<br>Reflective surface: 16 mm x 38 mm<br>Triple reflector size: 0.3 mm<br>Material: Plastic<br>Base material: Plastic<br>Chemical designation of the material: PMMA8N<br>Fastening: Screw type |

## Accessories

### Reflective tapes for laser and clear-glass applications

|   | Part no. | Designation   | Article         | Description  |
|---|----------|---------------|-----------------|--|
|  | 50110191 | REF 6-A-25x25 | Reflective tape | Design: Rectangular<br>Reflective surface: 25 mm x 25 mm<br>Triple reflector size: 0.3 mm<br>Material: Plastic<br>Chemical designation of the material: PMMA<br>Fastening: Self-adhesive |

#### Note



A list with all available accessories can be found on the Leuze website in the Download tab of the article detailed page.