

## Technical data sheet Stationary bar code reader

Part no.: 50040229

BCL 8 SM 100

### Contents

- Technical data
- Dimensioned drawings
- Electrical connection
- Diagrams
- Operation and display
- Notes
- Accessories



Figure can vary



## Technical data

### Basic data

Series	BCL 8
--------	-------

### Functions

Functions	Alignment mode
	AutoConfig
	AutoRefAct
	Daisy Chain
	I/O
	LED indicator
	Multiple read
	Output format selectable
	Reading gate control
	Reference code comparison

### Read data

Code types, readable	2/5 Interleaved
	Codabar
	Code 128
	Code 39
	Code 93
	EAN 128
	EAN 8/13
	EAN Addendum
	Pharma Code
	Pharmacode (available upon consultation)
	UPC
Scanning rate, typical	600 scans/s
Bar codes per reading gate, max. number	63 Piece(s)

### Optical data

Reading distance	25 ... 145 mm
Light source	Laser, Red
Laser light wavelength	655 nm
Laser class	2, IEC / EN 60825-1:2014
Transmitted-signal shape	Continuous
Usable opening angle (reading field opening)	60 °
Modulus size	0.15 ... 0.5 mm
Reading method	Line scanner
Scanning rate	600 scans/s
Beam deflection	Via rotating polygon wheel
Light beam exit	Lateral with deflecting mirror

### Electrical data

Protective circuit	Short circuit protected
--------------------	-------------------------

#### Performance data

Supply voltage $U_B$	4.75 ... 5.5 V, DC
Current consumption, max.	250 mA

### Inputs/outputs selectable

Output current, max.	20 mA
Number of inputs/outputs selectable	1 Piece(s)
Voltage type, outputs	DC
Switching voltage, outputs	Typ. $U_B / 0$ V
Voltage type, inputs	DC
Switching voltage, inputs	Max. 24 V DC
	Typ. $U_B / 0$ V
Input current, max.	20 mA

#### Input/output 1

Function	Freely configurable
----------	---------------------

### Interface

Type	RS 232
------	--------

#### RS 232

Function	Process
Transmission speed	4,800 ... 57,600 Bd
Data format	Adjustable
Start bit	1
Data bit	7,8
Stop bit	1.2
Parity	Adjustable
Transmission protocol	Adjustable
Data encoding	ASCII
	HEX

### Service interface

Type	RS 232
------	--------

#### RS 232

Function	Service
----------	---------

### Connection

Number of connections	1 Piece(s)
-----------------------	------------

#### Connection 1

Function	Data interface
	PWR / SW IN / OUT
Type of connection	Connector
Thread size	M12
Type	Male
Material	Metal
No. of pins	5 -pin
Encoding	A-coded

### Mechanical data

Design	Cubic
Dimension (W x H x L)	58 mm x 75 mm x 17.4 mm
Housing material	Metal
Metal housing	Zinc
Lens cover material	Glass
Net weight	120 g
Housing color	Red
Type of fastening	Dovetail grooves
	Mounting thread
	Through-hole mounting
	Via optional mounting device

## Technical data

### Operation and display

Type of display	LED
Number of LEDs	2 Piece(s)

### Environmental data

Ambient temperature, operation	0 ... 40 °C
Ambient temperature, storage	-20 ... 60 °C
Relative humidity (non-condensing)	0 ... 90 %

### Certifications

Degree of protection	IP 67
Protection class	III
Certifications	c UL US
Test procedure for EMC in accordance with standard	EN 61000-6-2, -3
Test procedure for shock in accordance with standard	IEC 60068-2-27, test Ea
Test procedure for vibration in accordance with standard	IEC 60068-2-6, test Fc
US patents	US 6,735,007 B
	US 6,822,774 B

### Classification

Customs tariff number	84719000
eCl@ss 5.1.4	27280102
eCl@ss 8.0	27280102
eCl@ss 9.0	27280102
eCl@ss 10.0	27280102
eCl@ss 11.0	27280102
ETIM 5.0	EC002550
ETIM 6.0	EC002550
ETIM 7.0	EC002550

# Dimensioned drawings

All dimensions in millimeters

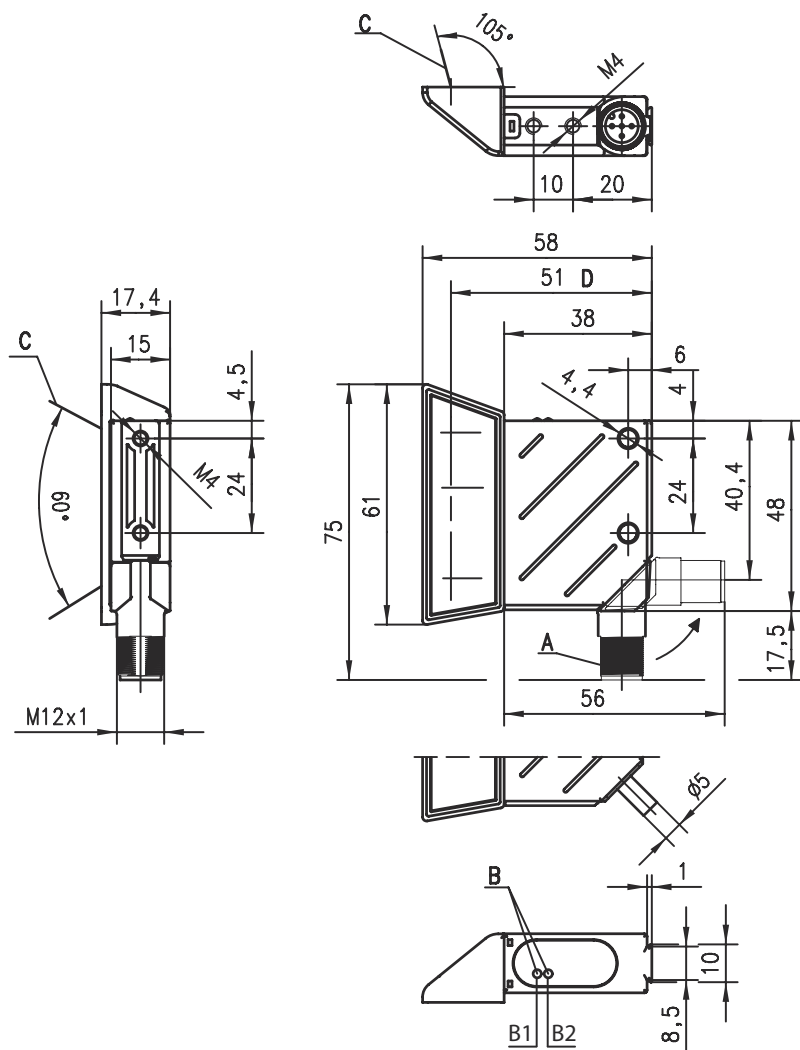

- A Turning connector, turnable by 90°
- B1 Status LED
- B2 Decode LED
- C Laser beam
- D Optical axis

## Electrical connection

### Connection 1

Function	Data interface
	PWR / SW IN / OUT
Type of connection	Connector
Thread size	M12
Type	Male
Material	Metal
No. of pins	5 -pin
Encoding	A-coded

# Electrical connection

Pin	Pin assignment
1	+5 V DC
2	RS 232 TxD
3	GND
4	RS 232 RxD
5	SW IN/OUT

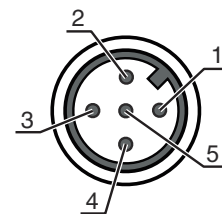

## Diagrams

### Reading field curve

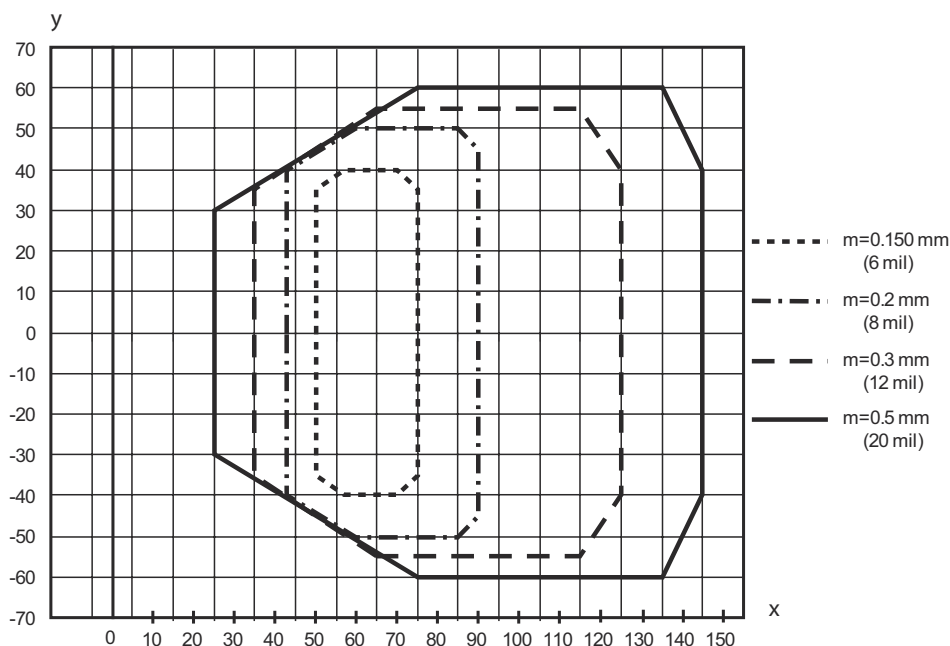

x Reading field distance [mm]  
 y Reading field width [mm]

## Operation and display

LED	Display	Meaning
1	Green, flashing	Device ok, initialization phase
	Green, continuous light	Operational readiness
	Red, flashing	Device OK, warning set
	Red, continuous light	Device error
	Orange, flashing	Service operation
2	Green, continuous light	Reading successful
	Red, continuous light	No reading result
	Orange, continuous light	Reading gate active

## Notes

<b>Observe intended use!</b>	
	<ul style="list-style-type: none"> <li>⌘ This product is not a safety sensor and is not intended as personnel protection.</li> <li>⌘ The product may only be put into operation by competent persons.</li> <li>⌘ Only use the product in accordance with its intended use.</li> </ul>



<b>For UL applications:</b>	
	<ul style="list-style-type: none"> <li>⌘ For UL applications, use is only permitted in Class 2 circuits in accordance with the NEC (National Electric Code).</li> </ul>

<b>WARNING! LASER RADIATION – CLASS 2 LASER PRODUCT</b>	
	<p><b>Do not stare into beam!</b>  <b>The device satisfies the requirements of IEC/EN 60825-1:2014 safety regulations for a product of laser class 2 as well as the U.S. 21 CFR 1040.10 regulations with deviations corresponding to "Laser Notice No. 56" from May 08, 2019.</b></p> <ul style="list-style-type: none"> <li>⌘ Never look directly into the laser beam or in the direction of reflected laser beams! If you look into the beam path over a longer time period, there is a risk of injury to the retina.</li> <li>⌘ Do not point the laser beam of the device at persons!</li> <li>⌘ Interrupt the laser beam using a non-transparent, non-reflective object if the laser beam is accidentally directed towards a person.</li> <li>⌘ When mounting and aligning the device, avoid reflections of the laser beam off reflective surfaces!</li> <li>⌘ CAUTION! Use of controls or adjustments or performance of procedures other than specified herein may result in hazardous light exposure.</li> <li>⌘ Observe the applicable statutory and local laser protection regulations.</li> <li>⌘ The device must not be tampered with and must not be changed in any way.                      There are no user-serviceable parts inside the device.                      Repairs must only be performed by Leuze electronic GmbH + Co. KG.</li> <li>⌘ If the scanner motor fails during the emission of laser radiation, the limit value of laser class 2 in accordance with IEC 60825-1:2014 could be exceeded.                      The device has safeguards to prevent this occurrence.</li> <li>⌘ If the emitted laser beam is at a standstill, immediately disconnect the faulty bar code reader from the voltage supply.</li> <li>⌘ The BCL8 emits scanned optical radiation at a wavelength of 655 nm (red).</li> <li>⌘ Looking at the device's mirror and operating at the lowest scanning rate (500 scans/s) at a viewing distance of 100 mm results in pulses with a pulse duration shorter than 420 µs on the retina of the eye. The total pulse peak power at the exit window is less than 1.7 mW.</li> <li>⌘ The average laser power is less than 1 mW in accordance with laser class 2 acc. to IEC 60825-1:2014</li> </ul>



NOTE	
	<p><b>Affix laser information and warning signs!</b>  <b>Laser information and warning signs are affixed to the device. In addition, self-adhesive laser information and warning signs (stick-on labels) are supplied in several languages.</b></p> <ul style="list-style-type: none"> <li>⌘ Affix the laser information sheet to the device in the language appropriate for the place of use. When using the device in the US, use the stick-on label with the "Complies with 21 CFR 1040.10" note.</li> <li>⌘ Affix the laser information and warning signs near the device if no signs are attached to the device (e.g. because the device is too small) or if the attached laser information and warning signs are concealed due to the installation position.</li> <li>⌘ Affix the laser information and warning signs so that they are legible without exposing the reader to the laser radiation of the device or other optical radiation.</li> </ul>

## Accessories

### Connection technology - Connection unit

	Part no.	Designation	Article	Description
	50104790	MA 8-01	Modular connection unit	Supply voltage: 10 ... 30 V Current consumption, max.: 50 mA Interface: RS 485 Connections: 3 Piece(s) Degree of protection: IP 67
	50101699	MA 8.1	Modular connection unit	Supply voltage: 10 ... 30 V Current consumption, max.: 50 mA Interface: RS 232 Connections: 3 Piece(s) Degree of protection: IP 67

### Connection technology - Connection cables

	Part no.	Designation	Article	Description
	50040757	KB 008-3000 A	Connection cable	Connection 1: Connector, M12, Axial, Female, A-coded, 5 -pin Connection 2: Open end Shielded: Yes Cable length: 3,000 mm Sheathing material: PUR
	50101941	KB-008-3000 A-S	Connection cable	Connection 1: Connector, M12, Axial, Male, A-coded, 5 -pin Connection 2: Open end Shielded: Yes Cable length: 3,000 mm Sheathing material: PUR

### Connection technology - Interconnection cables



	Part no.	Designation	Article	Description
	50133891	KDS S-M12-5A-M12-5A-P1-030	Interconnection cable	Connection 1: Connector, M12, Axial, Female, A-coded, 5 -pin Connection 2: Connector, M12, Axial, Male, A-coded, 5 -pin Shielded: Yes Cable length: 3,000 mm Sheathing material: PUR

### Mounting technology - Rod mounts

	Part no.	Designation	Article	Description
	50127177	BTU 008M-D10	Mounting system	Design of mounting device: Mounting system Fastening, at system: Sheet-metal mounting, For 10 mm rod Mounting bracket, at device: Screw type Type of mounting device: Turning, 360°, Adjustable, Clampable Material: Metal

## Accessories

### Mounting technology - Other

	Part no.	Designation	Article	Description
	50036196	BT 8-0	Mounting device	Design of mounting device: Mounting clamp Fastening, at system: Mounting thread Mounting bracket, at device: Clampable Type of mounting device: Rigid Material: Metal
	50104791	BT 8-01	Mounting device	Fastening, at system: Through-hole mounting Mounting bracket, at device: Screw type Material: Metal

#### Note



A list with all available accessories can be found on the Leuze website in the Download tab of the article detailed page.