

## Technical data sheet

### Smart camera

Part no.: 50137969

IPS 248i FIX-M3-102-I3-H

#### Contents

- Technical data
- Dimensioned drawings
- Electrical connection
- Diagrams
- Operation and display
- Part number code
- Notes
- Accessories



Figure can vary



Ethernet



## Technical data

### Basic data

Series	IPS 200i
Application	Single compartment depth
Chip	CMOS

### Special version

Special version	Heating
-----------------	---------

### Functions

Software functions	Compartment fine positioning
--------------------	------------------------------

### Optical data

Working range	100 ... 600 mm
Light source	LED, Infrared
Transmitted-signal shape	Pulsed
Camera resolution, horizontal	1,280 px
Camera resolution, vertical	960 px
Marker size (round)	5 ... 20 mm
Electronic shutter speed	0.068 ... 5 ms
Camera type	Monochrome

### Measurement data

Reproducibility (1 sigma)	0.1 mm, depending on the application
---------------------------	--------------------------------------

### Electrical data

Protective circuit	Polarity reversal protection Short circuit protected
--------------------	---------------------------------------------------------

#### Performance data

Supply voltage $U_B$	18 ... 30 V, DC
Average power consumption	8 W

#### Inputs

Number of digital switching inputs	3 Piece(s)
------------------------------------	------------

#### Switching inputs

Type	Digital switching input
Voltage type	DC

#### Outputs

Number of digital switching outputs	5 Piece(s)
-------------------------------------	------------

#### Switching outputs

Type	Digital switching output
Voltage type	DC
Switching current, max.	100 mA

#### Switching output 1

Switching principle	+24 V switching
---------------------	-----------------

#### Switching output 2

Switching principle	+24 V switching
---------------------	-----------------

#### Switching output 3

Switching principle	+24 V switching
---------------------	-----------------

#### Switching output 4

Switching principle	+24 V switching
---------------------	-----------------

#### Switching output 5

Switching principle	+24 V switching
---------------------	-----------------

### Interface

Type	Ethernet, PROFINET
------	--------------------

#### Ethernet

Architecture	Client Server
Address assignment	DHCP Manual address assignment
Transmission speed	10 Mbit/s 100 Mbit/s
Function	Process
Switch functionality	None
Transmission protocol	TCP/IP, UDP

#### Profinet

Function	Process
Conformance class	B
Protocol	PROFINET RT
Transmission speed	100 Mbit/s

### Service interface

Type	Ethernet
------	----------

#### Ethernet

Function	Service
----------	---------

### Connection

Number of connections	2 Piece(s)
-----------------------	------------

#### Connection 1

Function	Signal IN Signal OUT Voltage supply
Type of connection	Connector
Thread size	M12
Type	Male
Material	Metal
No. of pins	12 -pin
Encoding	A-coded

#### Connection 2

Function	Configuration interface Data interface
Type of connection	Connector
Thread size	M12
Type	Female
Material	Metal
No. of pins	4 -pin
Encoding	D-coded

## Technical data

### Mechanical data

Design	Cubic
Dimension (W x H x L)	43 mm x 61 mm x 44 mm
Housing material	Metal Plastic
Metal housing	Diecast aluminum
Plastic housing	PC
Lens cover material	Plastic
Net weight	120 g
Housing color	Silver
Type of fastening	Mounting thread Via optional mounting device

### Operation and display

Type of display	LED
Number of LEDs	9 Piece(s)
Type of configuration	Configuration codes Teach-in Via web browser
Operational controls	Button(s)
Function of the operational control	Adjustment mode Auto-setup

### Environmental data

Ambient temperature, operation	-30 ... 50 °C
Ambient temperature, storage	-20 ... 70 °C
Relative humidity (non-condensing)	90 %

### Certifications

Degree of protection	IP 65
Protection class	III
Certifications	c UL US
Test procedure for EMC in accordance with standard	EN 61000-6-2 EN 61000-6-4
Test procedure for continuous shock in accordance with standard	IEC 60068-2-29, test Eb
Test procedure for vibration in accordance with standard	IEC 60068-2-6, test Fc

### Classification

Customs tariff number	84719000
eCl@ss 5.1.4	27310101
eCl@ss 8.0	27310101
eCl@ss 9.0	27310201
eCl@ss 10.0	27310101
eCl@ss 11.0	27310101
ETIM 5.0	EC002550
ETIM 6.0	EC002550
ETIM 7.0	EC002550

## Dimensioned drawings

All dimensions in millimeters

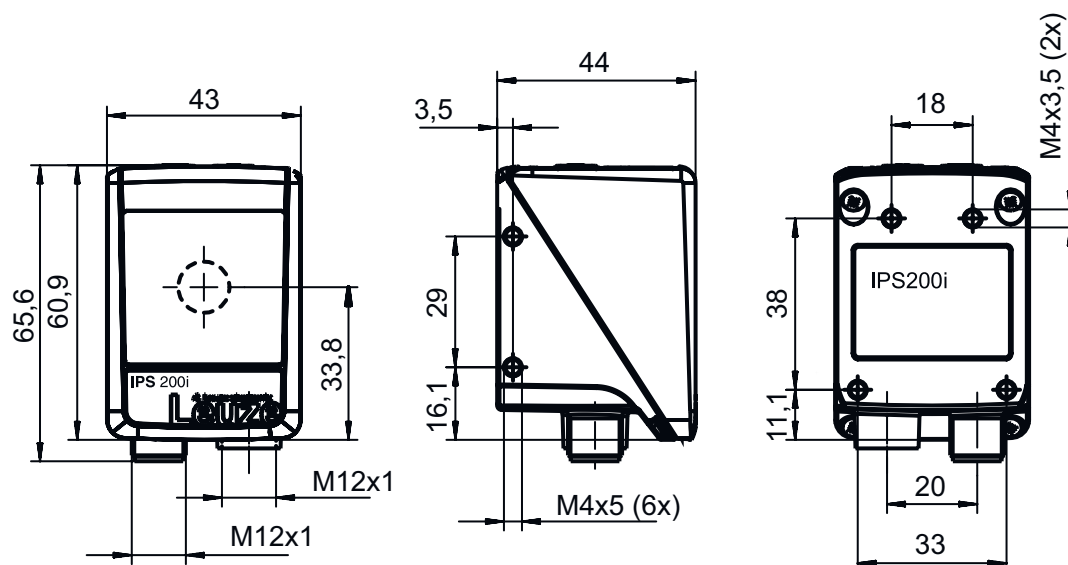

# Electrical connection

## Connection 1

## PWR / SWI / SWO

<b>Function</b>	Signal IN Signal OUT Voltage supply
<b>Type of connection</b>	Connector
<b>Thread size</b>	M12
<b>Type</b>	Male
<b>Material</b>	Metal
<b>No. of pins</b>	12 -pin
<b>Encoding</b>	A-coded

Pin	Pin assignment
-----	----------------

1	VIN
2	GND
3	SWIN 1
4	SWOUT 2
5	FE
6	n.c.
7	SWOUT 5
8	SWOUT 6
9	SWOUT 7
10	SWOUT 8
11	SWIO 3
12	SWIO 4

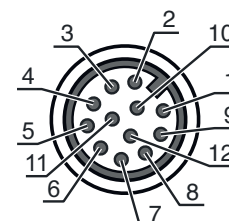

## Connection 2

## HOST

<b>Function</b>	Configuration interface Data interface
<b>Type of connection</b>	Connector
<b>Thread size</b>	M12
<b>Type</b>	Female
<b>Material</b>	Metal
<b>No. of pins</b>	4 -pin
<b>Encoding</b>	D-coded

Pin	Pin assignment
-----	----------------

1	TD+
2	RD+
3	TD-
4	RD-

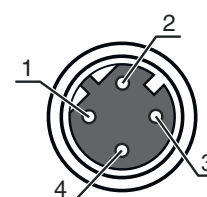

## Diagrams

Typical working distances for markers with different marker diameters

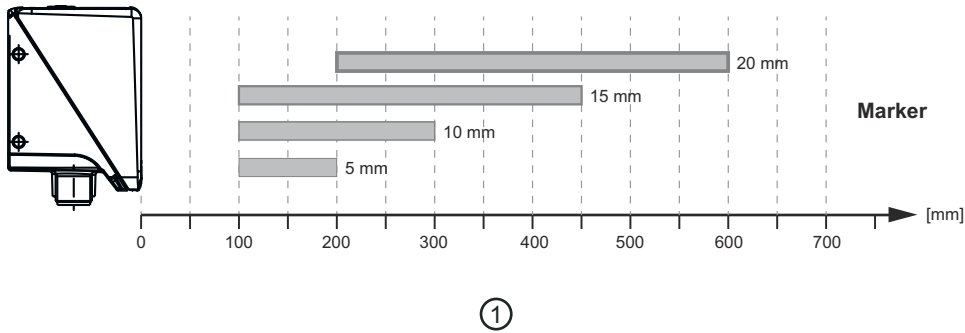

1 Distance [mm]

Mode of operation of the positioning sensor

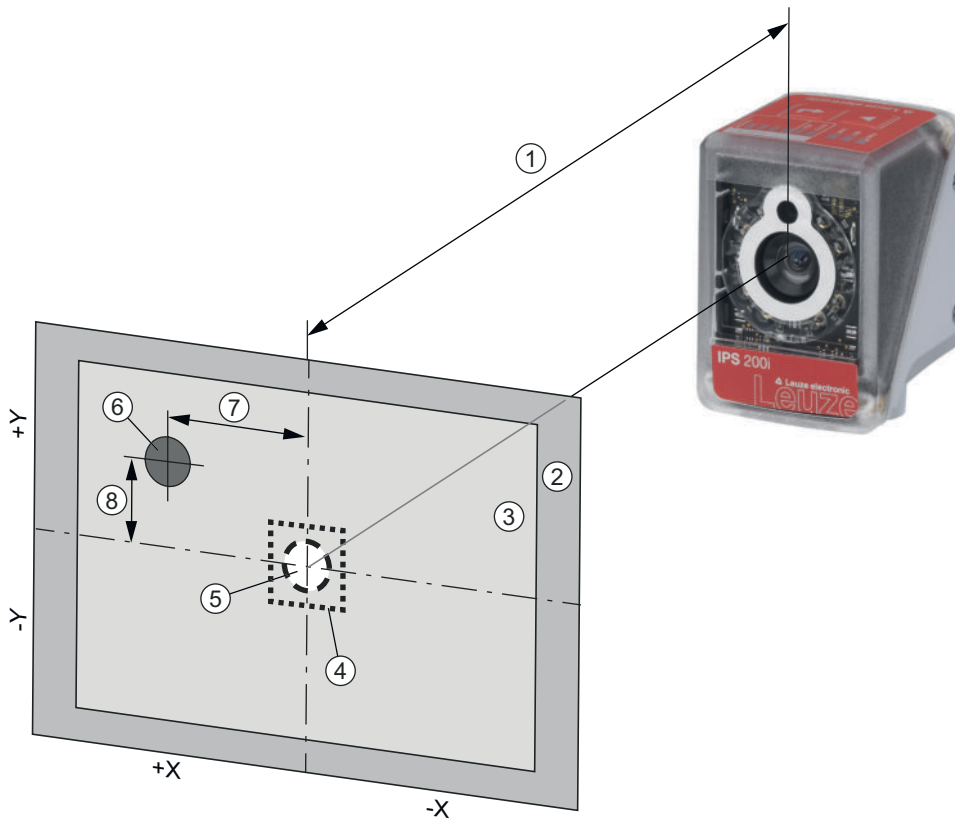

- |                            |                             |
|----------------------------|-----------------------------|
| 1 Working distance         | 5 Nominal position (marker) |
| 2 Field of view (FOV)      | 6 Actual position (marker)  |
| 3 Region of interest (ROI) | 7 X deviation               |
| 4 Tolerance range          | 8 Y deviation               |

## Diagrams

Typical fields of view (width x height in mm)

A	IPS 2xxi	IPS 4xxi ..F2	IPS 4xxi ..F4
100 mm	68 x 51	--	--
200 mm	136 x 102	--	--
250 mm	170 x 127	81 x 61	--
300 mm	204 x 153	98 x 73	74 x 57
350 mm	238 x 178	114 x 86	86 x 66
400 mm	272 x 204	131 x 98	99 x 76
450 mm	306 x 229	148 x 111	111 x 85
500 mm	340 x 255	164 x 123	123 x 95
1,300 mm	--	430 x 322	321 x 246
1,400 mm	--	463 x 347	345 x 265
1,500 mm	--	496 x 371	370 x 284
1,600 mm	--	530 x 396	395 x 303
1,700 mm	--	563 x 421	419 x 321
1,800 mm	--	596 x 446	444 x 340
1,900 mm	--	629 x 471	469 x 359
2,400 mm	--	--	592 x 454

A Working distance

NOTE The working range (capture range) of the camera results from the field of view minus the marker diameter

## Operation and display

LED	Display	Meaning
1 PWR	Off	No supply voltage
	Green, flashing	Initialization
	Green, continuous light	Operational readiness
	Orange, continuous light	Service operation
	Orange, flashing	Wave function
	Red, flashing	Device OK, warning set
	Red, continuous light	Device error
2 NET	Off	No supply voltage
	Green, flashing	Initialization
	Green, continuous light	Operational readiness
	Red, flashing	Communication error
3 LINK	Red, continuous light	Network error
	Green, continuous light	Ethernet connection is established
4 AUTO	Yellow, flashing	Data exchange active
	Green, flashing	Auto setup and teach-in of position
5 ADJ	Green, flashing	Alignment mode and teach-in of position
6 ---	Green, flashing	Flashing frequency signals the marker distance to the nominal position
	Green, continuous light	Marker is in nominal position
7 ---	Green, flashing	Flashing frequency signals the marker distance to the nominal position
	Green, continuous light	Marker is in nominal position
8 ---	Green, flashing	Flashing frequency signals the marker distance to the nominal position
	Green, continuous light	Marker is in nominal position
9 ---	Green, flashing	Flashing frequency signals the marker distance to the nominal position
	Green, continuous light	Marker is in nominal position

## Part number code

Part designation: **IPS AAAA BBB-DC-EEE-FG-H-J**

<b>IPS</b>	<b>Operating principle</b> Imaging Positioning Sensor (camera-based)
<b>AAAA</b>	<b>Series/interface (integrated fieldbus technology)</b> 208i: Ethernet TCP/IP 248i: PROFINET-IO, Ethernet TCP/IP, UDP
<b>BBB</b>	<b>Equipment</b> FIX: Fixed focal length
<b>C</b>	<b>Focus position</b> M: Medium Density (medium distance)
<b>D</b>	<b>Lens</b> 3: 4.1 mm
<b>EEE</b>	<b>Beam exit</b> 102: front
<b>F</b>	<b>Illumination</b> I: infrared light
<b>G</b>	<b>Resolution range</b> 3: 1280 x 960 pixels
<b>H</b>	<b>Protective screen</b> n/a: plastic G: Glass
<b>J</b>	<b>Special equipment</b> H: with heating

### Note



A list with all available device types can be found on the Leuze website at [www.leuze.com](http://www.leuze.com).

## Notes



### Observe intended use!



- ⌘ This product is not a safety sensor and is not intended as personnel protection.
- ⌘ The product may only be put into operation by competent persons.
- ⌘ Only use the product in accordance with its intended use.

## Accessories

### Connection technology - Connection cables

	Part no.	Designation	Article	Description
	50130281	KD S-M12-CA-P1-020	Connection cable	Connection 1: Connector, M12, Axial, Female, A-coded, 12 -pin Connection 2: Open end Shielded: Yes Cable length: 2,000 mm Sheathing material: PUR



## Accessories

	Part no.	Designation	Article	Description
	50135073	KS ET-M12-4A-P7-020	Connection cable	Suitable for interface: Ethernet Connection 1: Connector, M12, Axial, Male, D-coded, 4 -pin Connection 2: Open end Shielded: Yes Cable length: 2,000 mm Sheathing material: PUR

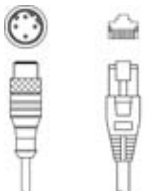

## Connection technology - Interconnection cables

	Part no.	Designation	Article	Description
	50135080	KSS ET-M12-4A-RJ45-A-P7-020	Interconnection cable	Suitable for interface: Ethernet Connection 1: Connector, M12, Axial, Male, D-coded, 4 -pin Connection 2: RJ45 Shielded: Yes Cable length: 2,000 mm Sheathing material: PUR

## Mounting technology - Mounting brackets

	Part no.	Designation	Article	Description
	50132151	BT 320M	Mounting bracket	Design of mounting device: Angle, L-shape Fastening, at system: Through-hole mounting Mounting bracket, at device: Screw type Type of mounting device: Rigid Material: Metal
	50144298	BT 330M	Mounting bracket	Design of mounting device: Angle, L-shape Fastening, at system: Through-hole mounting Mounting bracket, at device: Screw type Type of mounting device: Adjustable Material: Metal



## Mounting technology - Rod mounts

	Part no.	Designation	Article	Description
	50132150	BTU 320M-D12	Mounting system	Design of mounting device: Mounting system Fastening, at system: For 12 mm rod Mounting bracket, at device: Screw type Type of mounting device: Clampable, Adjustable, Turning, 360° Material: Metal
	50144299	BTU 330M-1	Mounting device	Design of mounting device: Mounting system Fastening, at system: For 10-16 mm rods Mounting bracket, at device: Screw type Type of mounting device: Adjustable, Turning, 360° Material: Metal



## Accessories

### Standard reflectors

	Part no.	Designation	Article	Description
	50130343	MTKZ 13-30 SET	Reflector	Design: Round Reflection surface diameter: 15 mm Material: Plastic Base material: Plastic Chemical designation of the material: PA Fastening: Clip Suitable for bore hole diameter: 12.5 ... 13.5 mm Suitable for material thickness: 0.8 ... 5 mm Processing temperature: 5 ... 45 °C
	50129092	MTKZ 15-30 SET	Reflector	Design: Round Reflection surface diameter: 15 mm Material: Plastic Base material: Plastic Chemical designation of the material: PA Fastening: Clip Suitable for bore hole diameter: 14.5 ... 15.5 mm Suitable for material thickness: 0.8 ... 5 mm Processing temperature: 5 ... 45 °C

### General

	Part no.	Designation	Article	Description
	50144030	IL AL 034/031 IR 110 H	Illumination	Special version: Heating Functions: Strobed operation (edge-triggered), no continuous operation

#### Note



A list with all available accessories can be found on the Leuze website in the Download tab of the article detailed page.