

Technical data sheet

Single beam safety device receiver

Part no.: 66553000

MLD520-R1

Contents

- Technical data
- Dimensioned drawings
- Electrical connection
- Operation and display
- Suitable transmitters
- Part number code
- Accessories



Figure can vary



Technical data

Basic data

Series	MLD 500
--------	---------

Functions

Functions	Contactor monitoring (EDM), selectable Start/restart interlock (RES), selectable
-----------	---

Characteristic parameters

Type	4, IEC/EN 61496
SIL	3, IEC 61508
SILCL	3, IEC/EN 62061
Performance Level (PL)	e, EN ISO 13849-1
MTTF _d	204 years, EN ISO 13849-1
PFH _D	6.6E-09 per hour
Mission time T _M	20 years, EN ISO 13849-1
Category	4, EN ISO 13849

Electrical data

Protective circuit	Overvoltage protection Short circuit protected
--------------------	---

Performance data

Supply voltage U _B	24 V, DC, -20 ... 20 %
Current consumption, max.	150 mA, Without external load
Fuse	External with max. 3 A

Inputs

Number of digital switching inputs	3 Piece(s)
------------------------------------	------------

Switching inputs

Type	Digital switching input
Switching voltage high, min.	18.2 V
Switching voltage low, max.	2.5 V
Switching voltage, typ.	23 V
Voltage type	DC
Switching current, max.	5 mA

Outputs

Number of safety-related switching outputs (OSSDs)	2 Piece(s)
Number of digital switching outputs	1 Piece(s)

Safety-related switching outputs

Type	Safety-related switching output OSSD
Switching voltage high, min.	18.2 V
Switching voltage low, max.	2.5 V
Switching voltage, typ.	23 V
Voltage type	DC
Current load, max.	380 mA
Load inductivity	2,200,000 µH
Load capacity	0.3 µF
Residual current, max.	0.2 mA
Residual current, typ.	0.002 mA
Voltage drop	1 V

Safety-related switching output 1

Switching element	Transistor, PNP
-------------------	-----------------

Safety-related switching output 2

Switching element	Transistor, PNP
-------------------	-----------------

Switching outputs

Switching voltage high, min.	18.2 V
Switching voltage low, max.	2.5 V
Switching voltage, typ.	23 V
Voltage type	DC

Switching output 1

Assignment	Connection 1, pin 1
Switching element	Transistor, PNP
Switching principle	+24 V switching
Function	"State of OSSDs" signal output

Timing

Response time	25 ms
Restart delay time	100 ms

Connection

Number of connections	1 Piece(s)
-----------------------	------------

Connection 1

Function	Machine interface
Type of connection	Connector
Thread size	M12
Material	Metal
No. of pins	8 -pin

Cable properties

Permissible conductor cross section, typ.	0.25 mm ²
Permissible cable resistance to load, max.	200 Ω

Mechanical data

Design	Cubic
Dimension (W x H x L)	52 mm x 193 mm x 64.7 mm
Housing material	Metal
Metal housing	Aluminum
Lens cover material	Plastic / PMMA
Material of end caps	Diecast zinc
Net weight	600 g
Housing color	Yellow, RAL 1021
Type of fastening	Groove mounting Swivel mount

Operation and display

Type of display	LED
Number of LEDs	1 Piece(s)

Environmental data

Ambient temperature, operation	-30 ... 55 °C
Ambient temperature, storage	-40 ... 75 °C
Relative humidity (non-condensing)	0 ... 95 %

Technical data

Certifications

Degree of protection	IP 67
Protection class	III
Certifications	c CSA US c TÜV NRTL US TÜV Süd
US patents	US 6,418,546 B US 7,741,595 B

Classification

Customs tariff number	85365019
eCl@ss 5.1.4	27272701
eCl@ss 8.0	27272701
eCl@ss 9.0	27272701
eCl@ss 10.0	27272701
eCl@ss 11.0	27272701
ETIM 5.0	EC001831
ETIM 6.0	EC001831
ETIM 7.0	EC001831

Dimensioned drawings

All dimensions in millimeters

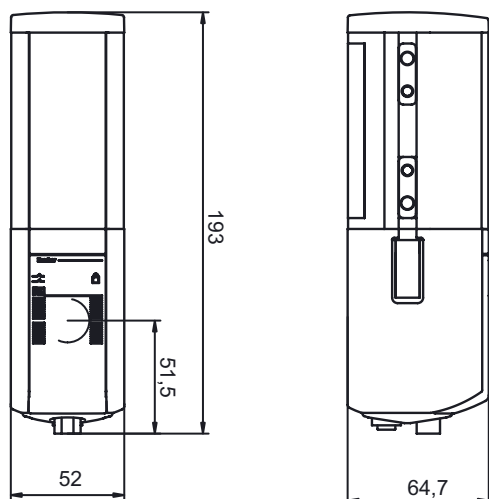

Electrical connection

Connection 1

Function	Machine interface
Type of connection	Connector
Thread size	M12
Type	Male
Material	Metal
No. of pins	8 -pin
Encoding	A-coded

Electrical connection

Pin	Pin assignment	Conductor color
1	RES/OSSD status signal	White
2	+24V	Brown
3	EDM	Green
4	MODE	Yellow
5	OSSD2	Gray
6	OSSD1	Pink
7	0 V	Blue
8	n.c.	Red



Operation and display

LED	Display	Meaning
1	Red, continuous light	OSSD off.
	Green, continuous light	OSSD on
	Red, flashing, 1 Hz	External error
	Red, flashing, 10 Hz	Internal error
	Green, flashing, 1 Hz	Weak signal, device not optimally aligned or soiled.
2	Yellow, continuous light	Start/restart interlock locked.

Suitable transmitters

	Part no.	Designation	Article	Description
	66501000	MLD500-T1	Single beam safety device transmitter	Operating range: 0.5 ... 70 m Light source: LED, Infrared Connection: Connector, M12, Metal, 5 -pin

Part number code

Part designation: MLDxyy-zab/t

MLD	Multiple light beam safety device
x	Series 3: MLD 300 5: MLD 500
yy	Function classes 00: transmitter 10: automatic restart 12: external testing 20: EDM/RES 30: muting 35: timing controlled 4-sensor muting
z	Device type T: transmitter R: receiver RT: transceiver xT: transmitter with high range xR: receiver for high range
a	Number of beams

Part number code

MLD Multiple light beam safety device

b	Option L: integrated laser alignment aid (for transmitter/receiver) M: integrated status indicator (MLD 320, MLD 520) or integrated status and muting indicator (MLD 330, MLD 335, MLD 510/A, MLD 530, MLD 535) E: connection socket for external muting indicator (AS-i models only)
----------	---

/t	Safety-related switching outputs (OSSDs), connection technology -: transistor output, M12 plug A: integrated AS-i interface, M12 plug, (safety bus system)
-----------	---





Note



A list with all available device types can be found on the Leuze website at www.leuze.com.

Accessories

Connection technology - Connection cables

	Part no.	Designation	Article	Description
	50137014	KD S-M12-5A-P1-150	Connection cable	Connection 1: Connector, M12, Axial, Female, A-coded, 5 -pin Connection 2: Open end Shielded: Yes Cable length: 15,000 mm Sheathing material: PUR
	50135129	KD S-M12-8A-P1-100	Connection cable	Connection 1: Connector, M12, Axial, Female, A-coded, 8 -pin Connection 2: Open end Shielded: Yes Cable length: 10,000 mm Sheathing material: PUR
	50135130	KD S-M12-8A-P1-150	Connection cable	Connection 1: Connector, M12, Axial, Female, A-coded, 8 -pin Connection 2: Open end Shielded: Yes Cable length: 15,000 mm Sheathing material: PUR
	50135131	KD S-M12-8A-P1-250	Connection cable	Connection 1: Connector, M12, Axial, Female, A-coded, 8 -pin Connection 2: Open end Shielded: Yes Cable length: 25,000 mm Sheathing material: PUR
	50135132	KD S-M12-8A-P1-500	Connection cable	Connection 1: Connector, M12, Axial, Female, A-coded, 8 -pin Connection 2: Open end Shielded: Yes Cable length: 50,000 mm Sheathing material: PUR

Accessories

Muting - Mounting systems

	Part no.	Designation	Article	Description
	424421	BT-SB10	Mounting bracket set	Design of mounting device: Mounting clamp Fastening, at system: Through-hole mounting Mounting bracket, at device: Clampable Type of mounting device: Swiveling Swivel range: -8 ... 8 ° Material: Metal

Services

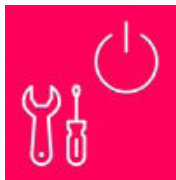
	Part no.	Designation	Article	Description
	S981050	CS40-I-140	Safety inspection "Safety light barriers"	Details: Checking of a safety light barrier application in accordance with current standards and guidelines. Inclusion of the device and machine data in a database, production of a test log per application. Conditions: It must be possible to stop the machine, support provided by customer's employees and access to the machine for Leuze employees must be ensured. Restrictions: Travel costs and accommodation expenses charged separately and according to expenditure.
	S981046	CS40-S-140	Start-up support	Details: For safety devices including stopping time measurement and initial inspection. Conditions: Devices and connection cables are already mounted, price not including travel costs and, if applicable, accommodation expenses. Restrictions: Max. 2 h., no mechanical (mounting) and electrical (wiring) work performed, no changes (attachments, wiring, programming) to third-party components in the nearby environment.

Note



A list with all available accessories can be found on the Leuze website in the Download tab of the article detailed page.