

IT 1911i / IT 1981i 2D-code hand-held scanner with Bluetooth for industrial use

en 03-2015/09 50123747-02

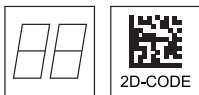

- Very sturdy hand-held scanner for 2D-codes and bar codes
- Transmission to base station via Bluetooth class 1 V2.1
- Very large range with high resolution and improved decoding
- Robust trigger button
- Acoustic signal, LED and vibration alarm following successful reading
- RS 232, USB and PS/2 interface
- Operating temperature from -20°C through 50°C
- Degree of protection IP 65



Accessories

- **TTL-RS 232 cable**
Part no. 50114517
- **PS/2 cable**
Part no. 50114519
- **USB cable, 3m**
Part no. 50114521
- **USB helix cable, 5m**
Part no. 50114523
- **Power supply unit for Base IT 19x1i**
Part no. 50123862

Dimensioned drawing

Electrical connection

for RS 232 cable

9-pin Sub-D	Signal	Base for IT 19x1i RJ41
2	TXD	4
3	RXD	5
5	GND	3
7	CTS	6
8	RTS	8
9	5VDC	7

for USB cable

USB type A	Signal	Base for IT 19x1i RJ41
1	5VDC	7
2	Data -	10
3	Data +	9
4	GND	3

for PS/2 cable

Mini DIN connector	Mini DIN socket	Signal	Base for IT 19x1i RJ41
1	-	PC Data	4
2	2	NC	
3	3	GND	3
4	4	5VDC	7
5	-	PC Clock	5
6	6	NC	
-	1	KB data	8
-	5	KB clock	6

We reserve the right to make changes

Specifications

Electrical data

Operating voltage U_B
Power consumption

IT 19x1i ...

3.7VDC internal battery

Base for IT 19x1i

4.5 ... 5.5VDC
max. 5W @ 5VDC

Li-ion battery

Capacity
Max. number of scans
Max. operating time
Charging time at 9VDC

2,000mAh
50,000
14h at 1 scan/s
4.5h for complete charge following complete discharge

Radio transmission

Frequency

Typ. operating range
Transmission speed

2.4 ... 2.4835GHz (ISM band)
frequency hopping, Bluetooth® V2.1, Class 1
100m
up to 1 Mbit/s

Interfaces

Interface type
Trigger

RS 232, PS/2 and USB
via button or serial command

Types of codes

2D-codes

Data Matrix ECC 200, MaxiCode, PDF417, MicroPDF, QR Code, Aztec, Aztec Mesas, Code 49, EAN/UCC Composite
2/5 Interleaved, Code 39, Code 128, Code 93, Codabar, UPC/EAN, Codablock, GS1 Databar

Bar codes

Optical data

Optical system
Symbol contrast
Light source
Read direction
Alignment aid

high-resolution pixel array 838x640
PCS 20% minimum
integrated diffuse LED, wavelength 617nm ± 18nm
omnidirectional, various tilt and rotational angles up to 45°
laser pattern 630 ... 680nm; IEC 60825-1:2007 Class 2

Mechanical data

Weight

Dimensions
Shock resistance

IT 19x1i...

IT 1911i...: approx. 380g,
IT 1981i...: approx. 420g
133 x 75 x 195mm
50 falls from a height of 2 m

Base for IT 19x1i

290g (without cable)
250 x 103 x 65mm
50 falls from a height of 1.2m

Environmental data

Ambient temp. (operation)
Ambient temp. (storage)
Relative humidity
Degree of protection

-20°C ... +50°C
-40°C ... +70°C
0 ... 95% (non-condensing)
IP 65

-20°C ... +50°C
-40°C ... +60°C
0 ... 95% (non-condensing)
IP 51

Reading field

IT 1911i ER-3

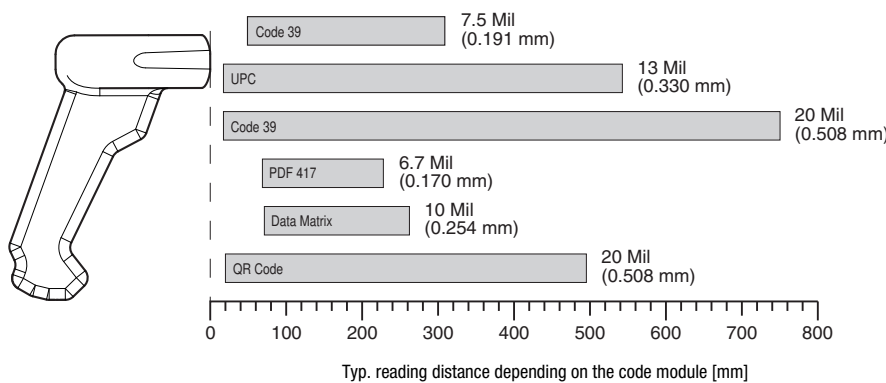

IT 1981i FR-3

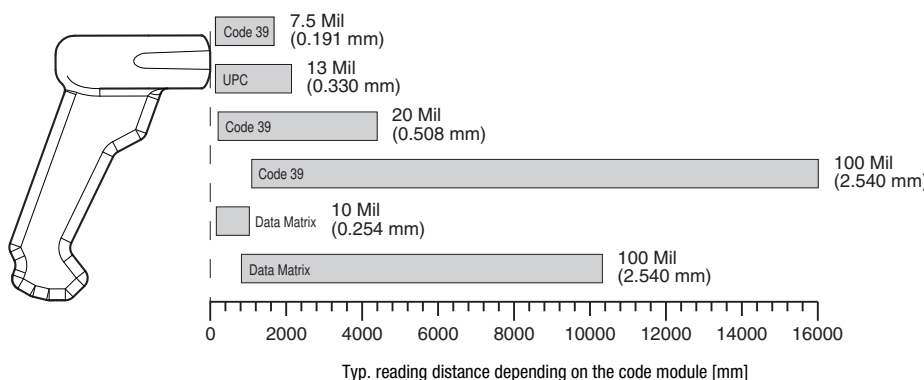

Tables

Remarks

Operate in accordance with intended use!

- ☞ The product may only be put into operation by competent persons.
- ☞ Only use the product in accordance with the intended use.

Hand-held scanner with integrated decoder for high-contrast codes suitable for industrial use.

Data transmission via configurable RS 232 interface.

Or keyboard-wedge operation via PS/2 or USB interface.

For a functional unit, an IT 19x1i hand-held scanner and a Base for IT 19x1i base station as well as a power supply unit and corresponding cable must be ordered.



Bluetooth is a trademark owned by Bluetooth SIG, Inc., U.S.A. and licensed to Honeywell.

IT 1911i / IT 1981i 2D-code hand-held scanner with Bluetooth for industrial use**Order guide****2D-code hand-held scanner (Extended Range optics with large operating range)**

IT 1911i ER-3 with Bluetooth data transmission

Part no.

50122434

2D-code hand-held scanner (Full Range optics with very large operating range)

IT 1981i FR-3 with Bluetooth data transmission

Part no.

50130495

Base station for 2D-code hand-held scanner with Bluetooth data transmission

Base for IT 19x1i with RS 232, PS/2 and USB interface

Part no.

50122431

Laser safety notices



ATTENTION, LASER RADIATION – LASER CLASS 2

Never look directly into the beam!

The device fulfills the EN 60825-1:2007 safety regulations for a product in **laser class 2** as well as the U.S. 21 CFR 1040.10 regulations with deviations corresponding to "Laser Notice No. 50" from June 24th, 2007.

- ↳ Never look directly into the laser beam or in the direction of reflecting laser beams!
If you look into the beam path over a longer time period, there is a risk of injury to the retina.
- ↳ Do not point the laser beam of the device at persons!
- ↳ Interrupt the laser beam using a non-transparent, non-reflective object if the laser beam is accidentally directed towards a person.
- ↳ When mounting and aligning the device, avoid reflections of the laser beam off reflective surfaces!
- ↳ **CAUTION!** Use of controls or adjustments or performance of procedures other than specified herein may result in hazardous light exposure.
- ↳ Observe the applicable statutory and local laser protection regulations.
- ↳ The device must not be tampered with and must not be changed in any way.
There are no user-serviceable parts inside the device.
Repairs must only be performed by Leuze electronic GmbH + Co. KG.

NOTICE

Laser information and warning signs firmly attached to the device.

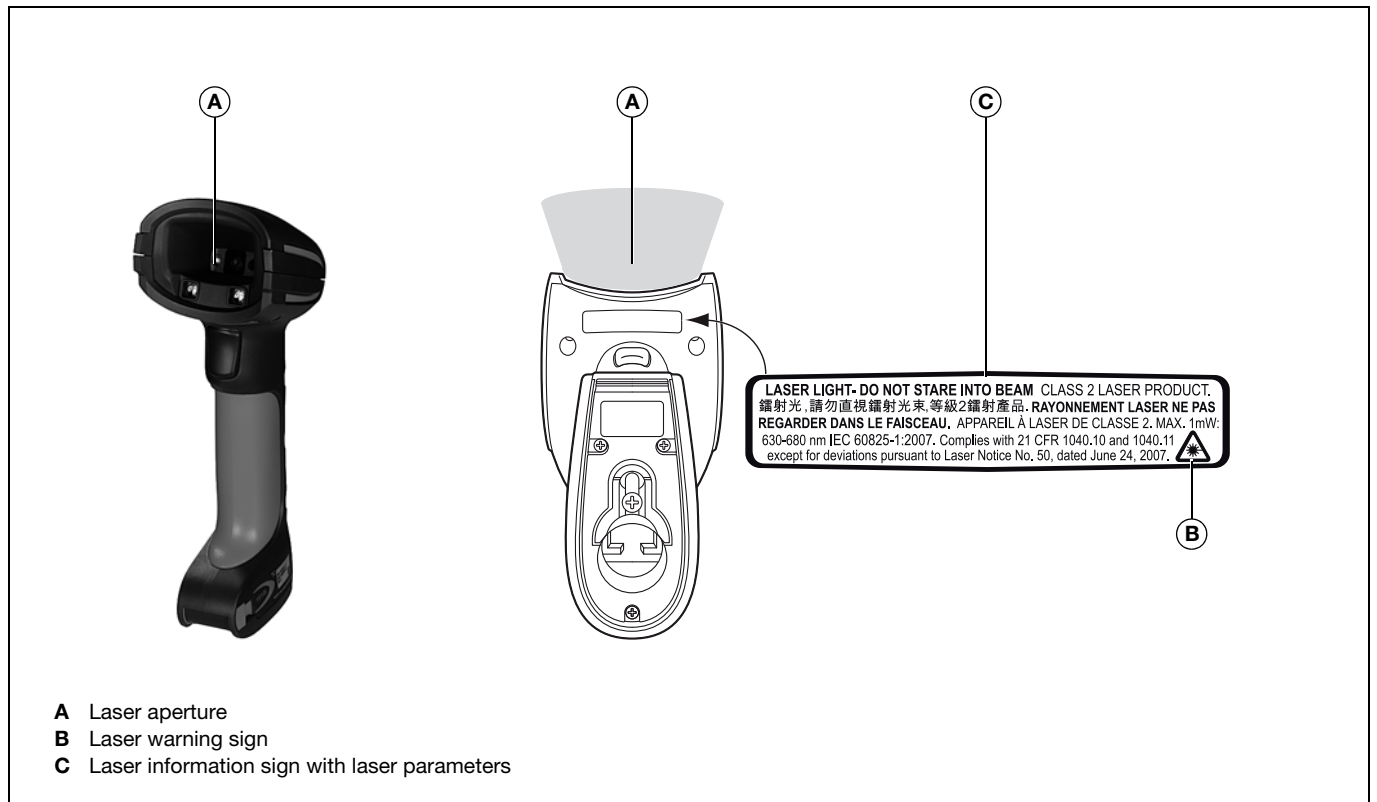

IT 1911i / IT 1981i 2D-code hand-held scanner with Bluetooth for industrial use

Switching off the computer

Information on switching off and shutting down the connected computer - which must always be performed before connecting peripheral devices, such as a scanner - can be found in the appropriate operating instructions for your computer.

Connecting the base station

Shown in the adjacent figure are the locations for installing the cables on the base station. The individual installation steps are described in the following.

1. To secure the interface cable to the base station, proceed as follows: plug the RJ 41 connector into the socket on the bottom of the base station until the cable clicks into place.
2. Connect the interface cable to the appropriate connection socket on the computer.
3. You may need a power supply unit for supplying voltage if you would like to charge the hand-held scanner via the base station or use an RS 232 interface. Use the pin assignments (see "Electrical connection" on page 1) to select the appropriate cable for your application.
4. Connect the power supply unit to the power socket.
5. Use the code for the respective application to configure the hand-held scanner, see chapter "Parameterization".
6. Check the operational readiness of the scanner by pointing the scanning surface towards a flat surface and pulling the trigger. A red laser pattern as well as the red illumination should now be visible. Now scan a sample label.
The scanner emits an audible signal to confirm that the label has been read; if necessary, the data are now passed on to the computer.

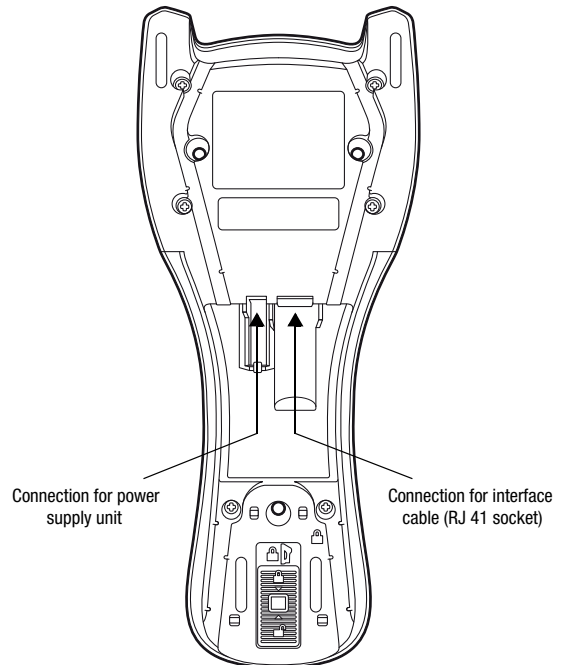

Notice!

To charge the hand-held scanner, the power supply unit must be plugged in and the hand-held scanner placed in the base station.

Parameterization

The hand-held scanner can always be configured using bar codes. To do this, the bar code must first be selected on the package insert and then the trigger actuated in order to read the code. The configuration is then immediately accepted and executed.

Several of the most important configurations are listed in the following.

A second option is to configure the hand-held scanner with the USB and RS 232 interfaces with the aid of the **EZ Config PC** program. You can download and install this program from our homepage at www.leuze.com.

The program can be used to make settings and transfer them to the hand-held scanner. The configuration can also be stored so that it can be reused at a later time.

More information can also be found in the user's guide.

The standard applications are described and summarized below.



Notice!

Additional information on the device and short instructions can be found on the Internet at www.leuze.com.

Resetting the IT 1911i / IT 1981i to factory settings

To reset all parameters to factory settings, scan the adjacent bar code.



Attention!
All settings are lost!!!

Return the hand-held scanner to the base station to apply the settings. This procedure is concluded with audible confirmation signals.

You may then continue making settings or operation of the device.

Trigger

To activate the read process, a trigger signal is to be sent via the serial RS 232 interface or USB interface (COM port emulation only). The command is to be sent at the set baud rate, parity, and data and stop bits.

The command for activation is: **SYN T CR** ASCII decimal values: 022; 084; 013

To cancel read readiness, send a deactivation.

The command for deactivation is: **SYN U CR** ASCII decimal values: 022; 085; 013

Following a successful read operation, the hand-held scanner deactivates itself.

The second option is activation via the built-in trigger button.

Configuration for the Leuze standard protocol

Scan the adjacent 2D-code.

The hand-held scanner is set to the following transmission parameters:
RS 232 transmission with 9,600 baud, 8 data bits, 1 stop bit, no parity, prefix <STX>, postfixes <CR><LF>.

Return the hand-held scanner to the base station to apply the settings. This procedure is concluded with audible confirmation signals.

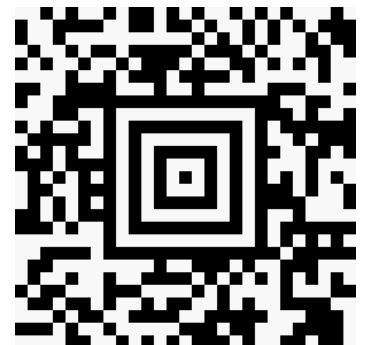

Notice!
To charge the hand-held scanner, the power supply unit must be plugged in and the hand-held scanner placed in the base station.

IT 1911i / IT 1981i 2D-code hand-held scanner with Bluetooth for industrial use

Connecting the IT 1911i / IT 1981i to the serial PC interface

With TTL-RS232 cable (part no. 50114517)

Required parts:

- 1x IT 1911i ER-3 or IT 1981i FR-3
- 1x 50122431 Base for IT 19x1i
- 1x 50114517 KB 232-1 IT 190x
- 1x 50123862 Power supply unit for Base for IT 19x1i

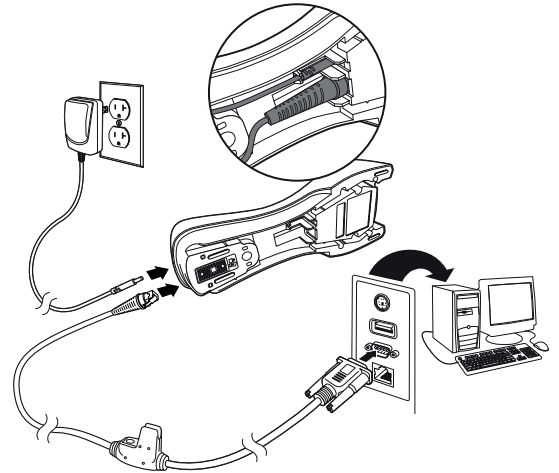

Notice!

Cable **KB 232-1 IT190x** (part no. 50114517) uses TTL-level (0V...5V) for data transmission. As an alternative to this, cable **KB 232-2 IT190x** (part no. 50115105) can be used. This cable works with the regular RS232 level (-12V...+12V) and therefore features a higher interference rejection. Both cables are connection compatible.

Procedure:

1. Switch off the PC.
2. Connect the interface cable to a free COM port (RS 232) on the computer and to the base station.
3. Plug one end of the power supply unit cable into the base station and the other end into a free power socket.
4. Switch the PC back on.
5. Scan the adjacent bar code.
The hand-held scanner is set to the following transmission parameters:
RS 232 transmission with 115,200 baud, 8 data bits, 1 stop bit, no parity, postfixes <CR><LF>.
6. Return the hand-held scanner to the base station to apply the settings. This procedure is concluded with optical confirmation signals (green LED on the base station).
7. If necessary, adjust the transmission parameters of the used COM port to those of the hand-held scanner.



Attention!

We recommend connecting the base station directly to a PC or to the MA 21 or MA 41... connection units. If connecting to other components, please note that a voltage level range of 0 ... +5V (TTL level) is maintained on the data lines!



Notice!

To charge the hand-held scanner, the power supply unit must be plugged in and the hand-held scanner placed in the base station.

Connecting the IT 1911i / IT 1981i to the MA 2xxi

Required parts:

1x	IT 1911i ER-3 or IT 1981i FR-3
1x	50122431 Base for IT 1911i
1x	50114517 KB 232-1 IT 190x
1x	50123862 Power supply unit for Base for IT 1911i
1x	50113397 KB JST-HS-300
1x	MA 2xxi for the respective fieldbus system

Procedure:

1. Connect cable KB JST-HS-300 to the system connector on the MA 2xxi.
2. Connect the interface cable to cable KB JST-HS-300. Connect the interface cable and the power supply unit to the base station (see "Connecting the IT 1911i / IT 1981i to the serial PC interface").
3. Scan the adjacent 2D code.
The hand-held scanner is set to the following transmission parameters:
RS 232 transmission with 9,600 baud, 8 data bits, 1 stop bit, no parity, postfixes <CR><LF>.
4. Return the hand-held scanner to the base station to apply the settings. This procedure is concluded with audible confirmation signals.

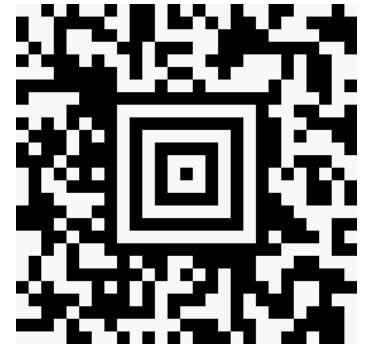

Notice!

To charge the hand-held scanner, the power supply unit must be plugged in and the hand-held scanner placed in the base station.

IT 1911i / IT 1981i 2D-code hand-held scanner with Bluetooth for industrial use

Connecting the IT 1911i / IT 1981i to the MA 21

Required parts:

1x	IT 1911i ER-3 or IT 1981i FR-3
1x	50122431 Base for IT 19x1i
1x	50114517 KB 232-1 IT 190x
1x	50123862 Power supply unit for Base for IT 19x1i
1x	50035421 KB 021 Z
1x	50030481 MA 21 100

Pin assignments KB021 Z:

Core color:	Signal	Terminal in the MA 21:
Brown	(RXD)	26
White	(TXD)	27
Blue	(GND)	28
Red	(VCC)	⊗
Black	(GND)	⊗
Bare (shield)	(PE)	21

Procedure:

1. Connect cable KB 021 Z to the MA 21... acc. to the above pin assignments.
2. Connect the interface cable to cable KB 021 Z. Connect the interface cable and the power supply unit to the base station (see "Connecting the IT 1911i / IT 1981i to the serial PC interface").
3. Scan the adjacent 2D code.
The hand-held scanner is set to the following transmission parameters:
RS 232 transmission with 9,600 baud, 7 data bits, 1 stop bit, even parity, postfixes <CR><LF>.
4. Return the hand-held scanner to the base station to apply the settings. This procedure is concluded with audible confirmation signals.



Notice!

To charge the hand-held scanner, the power supply unit must be plugged in and the hand-held scanner placed in the base station.

Connecting the IT 1911i / IT 1981i to the PS/2 interface

The operation of the hand-held scanner in keyboard emulation mode is described in this section. With this operating mode, a PC keyboard is emulated. The read data are written directly into the currently activated program. The data can thereby be further processed in all standard programs.

Required parts:

- 1x **IT 1911i ER-3 or IT 1981i FR-3**
- 1x **50122431 Base for IT 19x1i**
- 1x **50123862 Power supply unit for Base for IT 19x1i**
- 1x **50114519 KB PS2-1 IT 19xx**

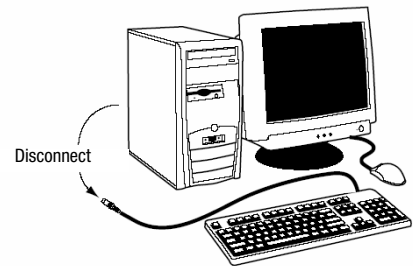

Procedure:

1. Switch off the PC.
2. Disconnect the keyboard.
3. Connect the cable for the base station between the keyboard and the PC.
4. Switch the PC back on.
5. Scan the 2D code shown below.
6. Return the hand-held scanner to the base station to apply the settings. This procedure is concluded with audible confirmation signals.

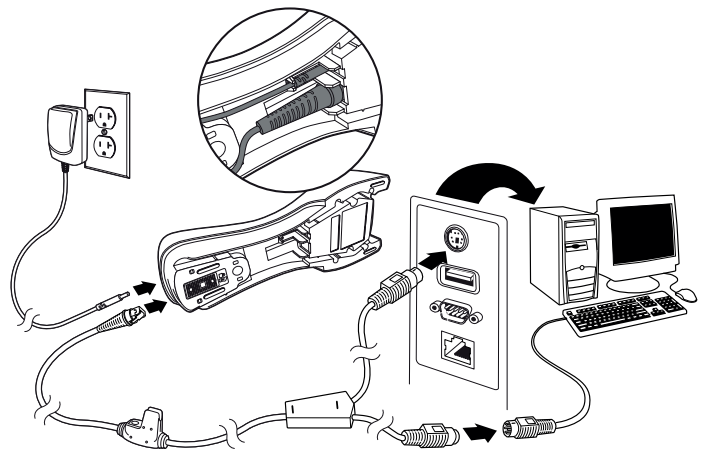

Notice!

To charge the hand-held scanner, the power supply unit must be plugged in and the hand-held scanner placed in the base station.

IT 1911i / IT 1981i 2D-code hand-held scanner with Bluetooth for industrial use

Connecting the IT 1911i / IT 1981i to the USB interface (keyboard emulation)

Operating the hand-held scanner in keyboard emulation mode on a USB port is described in this section. With this operating mode, a PC keyboard is emulated. The read data is written directly into the currently activated program. The data can therefore be further processed in all standard programs.

Required parts:

1x	IT 1911i ER-3 or IT 1981i FR-3
1x	50122431 Base for IT 19x1i
1x	50123862 Power supply unit for Base for IT 19x1i
1x	50114521 KB USB-1 IT190x (3m, straight)
or	
1x	50114523 KB USB-2 IT190x (5m, spiral)

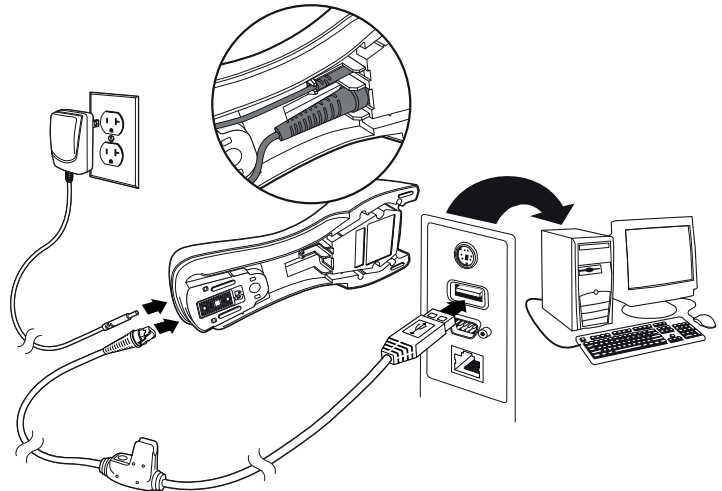

Procedure:

1. Connect the cable for the base station to a free USB port.
2. The scanner acknowledges this connection with a beep.
3. Scan the adjacent 2D code.
4. Return the hand-held scanner to the base station to apply the settings. This procedure is concluded with audible confirmation signals.



Notice!

To charge the hand-held scanner, the power supply unit must be plugged in and the hand-held scanner placed in the base station.

Connecting the IT 1911i / IT 1981i to the USB interface (COM port emulation)

The operation of the hand-held scanner as a serial interface on a USB port is described in this chapter. With this operating mode, a COM interface is emulated. The read data are sent to a new COM interface. The drivers with which this COM interface is emulated can be downloaded from our homepage at www.leuze.com. Thus, the data can be processed further in programs which expect data via COM interfaces.

Required parts:

- 1x **IT 1911i ER-3 or IT 1981i FR-3**
- 1x **50122431 Base for IT 19x1i**
- 1x **50123862 Power supply unit for Base for IT 19x1i**
- 1x **50114521 KB USB-1 IT190x (3m, straight)**
- or
- 1x **50114523 KB USB-2 IT190x (5m, spiral)**

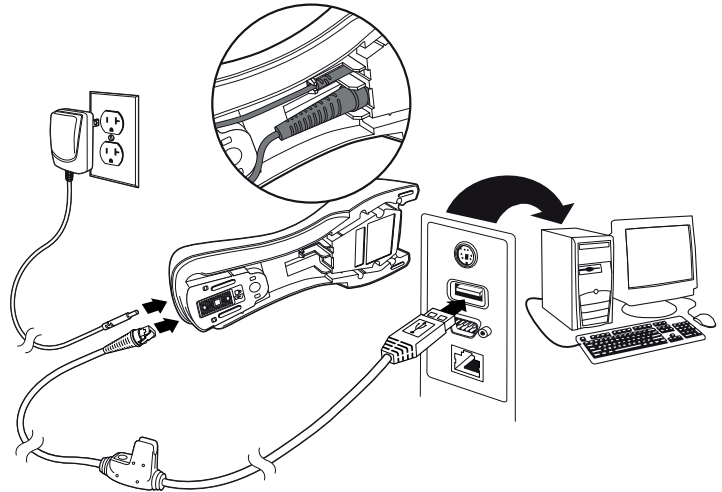

Procedure:

1. Install the USB serial driver (current version available at www.leuze.com).
2. Connect the cable for the base station to a free USB port.
3. The scanner acknowledges this connection with a beep.
4. Scan the adjacent 2D code.
5. Open a terminal program or your program for the serial interface, select the new COM port, and make the following settings: baud rate 115,200, 8 data bits, 1 stop bit, no parity, postfix <CR>.
6. Return the hand-held scanner to the base station to apply the settings. This procedure is concluded with audible confirmation signals.

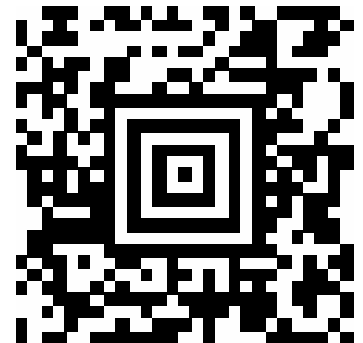

Notice!

To charge the hand-held scanner, the power supply unit must be plugged in and the hand-held scanner placed in the base station.