

Technical data sheet

Single beam safety device transmitter

Part no.: 50121914

SLS46CI-40.K28



Figure can vary

Contents

- Technical data
- Dimensioned drawings
- Electrical connection
- Operation and display
- Suitable receivers
- Notes
- Further information
- Accessories



Technical data

Basic data

Series	46C
--------	-----

Functions

Functions	Activation input
-----------	------------------

Characteristic parameters

Type	2, IEC/EN 61496, in combination with a suitable test monitoring unit, e.g. MSI-TR1B
SIL	1, IEC 61508, in combination with a suitable test monitoring unit, e.g. MSI-TR1B
SILCL	1, IEC/EN 62061, in combination with a suitable test monitoring unit, e.g. MSI-TR1B
Performance Level (PL)	c, EN ISO 13849-1:2008, In combination with a suitable test monitoring unit, e.g. MSI-TR1B
MTTF _d	400 years, EN ISO 13849-1
PFH _D	3E-10 per hour
Mission time T _M	20 years, EN ISO 13849-1
Category	2, EN ISO 13849, In combination with a suitable test monitoring unit, e.g. MSI-TR1B

Optical data

Operating range	0.5 ... 40 m
Operating range limit	0.5 ... 48 m
Light source	LED, Infrared
LED light wavelength	940 nm
LED group	1
Transmitted-signal shape	Pulsed
Opening angle, max.	-5 ... 5 °

Electrical data

Protective circuit	Polarity reversal protection Short circuit protected
--------------------	---

Performance data

Supply voltage U _B	24 V, DC, -20 ... 20 %, Incl. residual ripple
Residual ripple	10 %, From U _B
Open-circuit current	0 ... 40 mA

Inputs

Number of activation inputs	1 Piece(s)
-----------------------------	------------

Activation inputs

Voltage type	DC
Switching voltage	high: ≥8V low: ≤1.5V
Switching voltage high, min.	8 V
Switching voltage low, max.	1.5 V
Activation/disable delay	1 ms
Input resistance	10,000 Ω, -30 ... 30 %

Activation input 1

Assignment	Connection 1, conductor 4
Active switching state	High

Timing

Switching frequency	250 Hz
Response time	2.5 ms
Readiness delay	300 ms

Connection

Number of connections	1 Piece(s)
-----------------------	------------

Connection 1

Function	Signal IN Voltage supply
Type of connection	Cable
Cable length	2,000 mm
Sheathing material	PUR
Number of conductors	4 -wire
Wire cross section	0.21 mm ²

Mechanical data

Design	Cubic
Dimension (W x H x L)	20.5 mm x 76.3 mm x 44 mm
Housing material	Plastic
Plastic housing	PC-PBT
Lens cover material	Plastic / PMMA
Net weight	50 g
Housing color	Red
Type of fastening	Through-hole mounting
Compatibility of materials	ECOLAB

Operation and display

Type of display	LED
Number of LEDs	2 Piece(s)

Environmental data

Ambient temperature, operation	-30 ... 60 °C
Ambient temperature, storage	-30 ... 70 °C

Certifications

Degree of protection	IP 67 IP 69K
Protection class	III, Rating voltage 50V
Certifications	c TÜV NRTL US c UL US TÜV Süd
Standards applied	IEC 60947-5-2, IEC/EN 61496

Classification

Customs tariff number	85365019
eCl@ss 5.1.4	27272701
eCl@ss 8.0	27272701
eCl@ss 9.0	27272701
eCl@ss 10.0	27272701
eCl@ss 11.0	27272701
ETIM 5.0	EC001831
ETIM 6.0	EC001831
ETIM 7.0	EC001831

Dimensioned drawings

All dimensions in millimeters

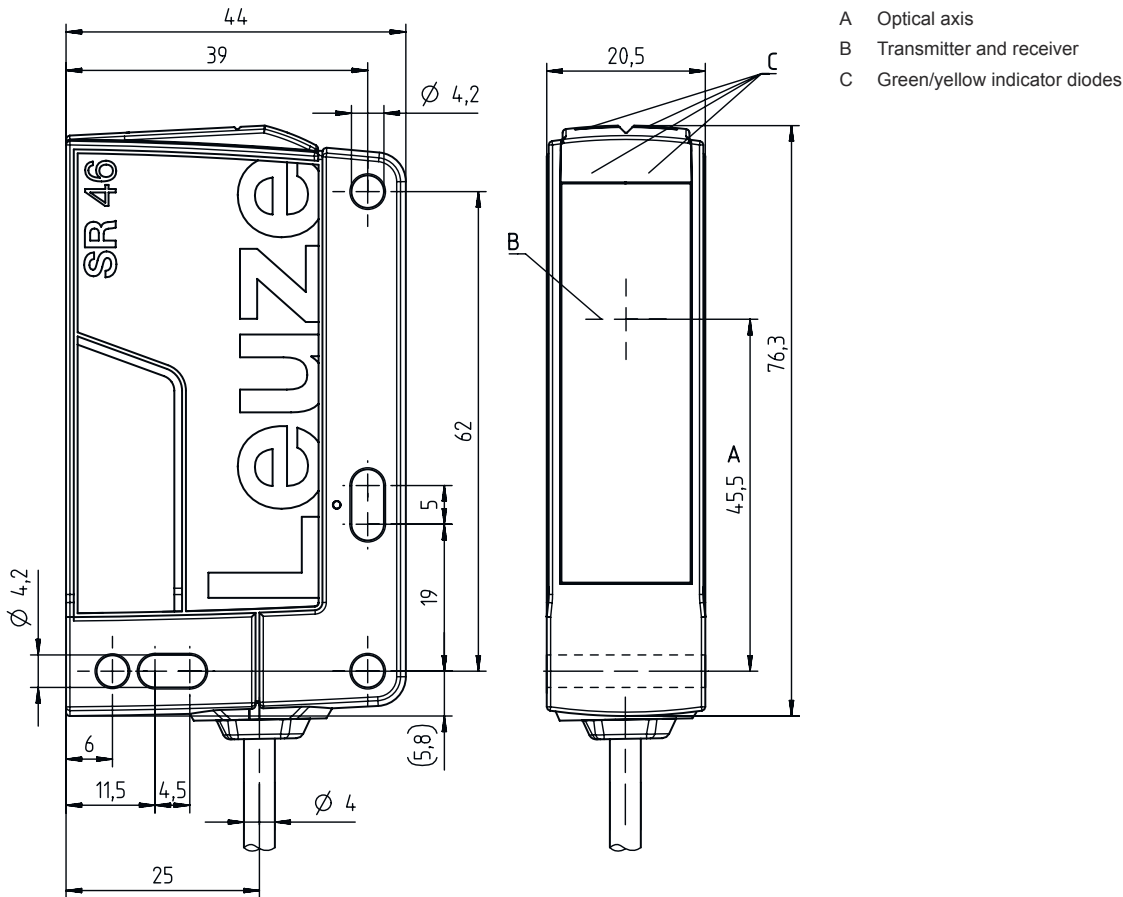

Electrical connection

Connection 1

Function	Signal IN
	Voltage supply
Type of connection	Cable
Cable length	2,000 mm
Sheathing material	PUR
Cable color	Black
Number of conductors	4 -wire
Wire cross section	0.21 mm ²

Conductor color

Conductor assignment

Brown	V+
White	n.c.
Blue	GND
Black	Active

Operation and display

LED	Display	Meaning
1	Green, continuous light	Ready

Operation and display

LED	Display	Meaning
2	Yellow, continuous light	Transmitter activated

Suitable receivers

	Part no.	Designation	Article	Description
	50121922	SLE46CI-40.K2/4P	Single beam safety device receiver	Response time: 2.5 ms Connection: Cable, 2,000 mm, PUR

Notes

⚠ Observe intended use!	
	<ul style="list-style-type: none"> ↪ The product may only be put into operation by competent persons. ↪ Only use the product in accordance with its intended use.

For UL applications:	
	<ul style="list-style-type: none"> ↪ Certification: UL 508, C22.2 No.14-13 ↪ Only for use in "class 2" circuits ↪ These proximity switches shall be used with UL Listed Cable assemblies rated 30V, 0.5A min, in the field installation, or equivalent (categories: CYJV/ CYJV7 or PVVA/PVVA7)

Further information

- Typ. operating range limit: max. attainable range without function reserve
- Operating range: recommended range with function reserve
- Light source: Average life expectancy 100,000h at an ambient temperature of 25 °C

Accessories

Connection technology - Connection unit

	Part no.	Designation	Article	Description
	547958	MSI-TR1B-01	Safety relay	

Accessories

	Part no.	Designation	Article	Description
	547959	MSI-TR1B-02	Safety relay	

Mounting technology - Mounting brackets

	Part no.	Designation	Article	Description
	50105315	BT 46	Mounting device	Design of mounting device: Angle, L-shape Fastening, at system: Through-hole mounting Mounting bracket, at device: Screw type Type of mounting device: Rigid Material: Metal

Mounting technology - Rod mounts

	Part no.	Designation	Article	Description
	50122797	BTU 346M-D12	Mounting system	Design of mounting device: Mounting system Fastening, at system: For 12 mm rod, Sheet-metal mounting Mounting bracket, at device: Screw type Type of mounting device: Turning, 360°, Adjustable, Clampable Material: Metal

Muting - Mounting systems

	Part no.	Designation	Article	Description
	50117252	BTU 300M-D12	Mounting system	Design of mounting device: Mounting system Fastening, at system: For 12 mm rod, Sheet-metal mounting Mounting bracket, at device: Screw type, Suited for M4 screws Type of mounting device: Clampable, Adjustable, Turning, 360° Material: Metal

Note



A list with all available accessories can be found on the Leuze website in the Download tab of the article detailed page.