

L46C

Red-light throughbeam photoelectric sensor with alignment display

en 01 - 2015/0650129626



150m



- Throughbeam photoelectric sensor with large operating range and high function reserve in red light version
- Sensitivity adjustment and delay before start-up for optimal adaptation to the application
- Time-saving, exact alignment and function check through additional, highly visible display on front side
- Warning output for sustained availability (preailure message)
- Activation input for sensor test
- Various switching output functions for universal connection to existing control environment
- Robust plastic housing in degrees of protection IP67 and IP69K



Accessories:

(available separately)

- Mounting systems (BT 46, BTU 300M, BT 300, BTU 346)
- M12 connectors (KD ...)
- Ready-made cables (K-D ...)
- Alignment aid (SAT 5)
- Laser alignment aid (ARH 46C)

Dimensioned drawing

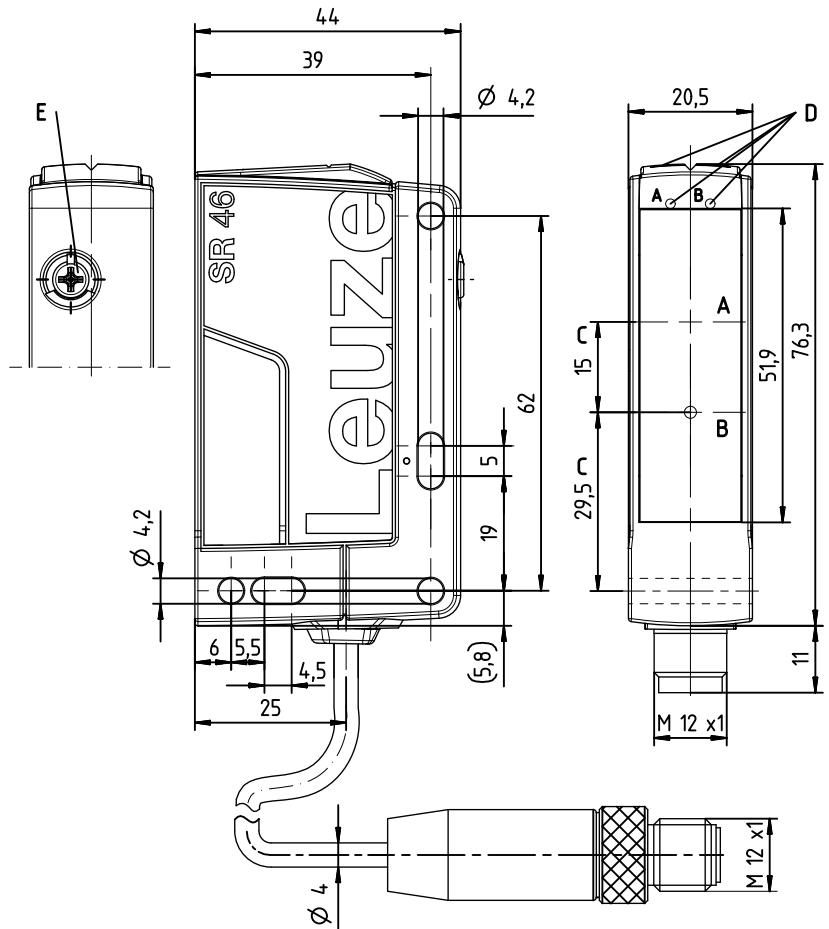

- A** Transmitter (LS) / Receiver (LE)
- B** Yellow indicator diode Transmitter: active/not active
Receiver: signal/no signal
- C** Optical axis
- D_A** Green indicator diode
- D_B** Yellow indicator diode
- E** Sensitivity adjustment (only on receiver)

Electrical connection

Transmitter, 4-pin connector

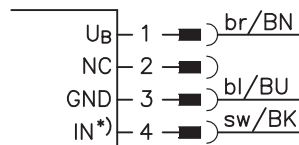

Receiver, 4-pin connector

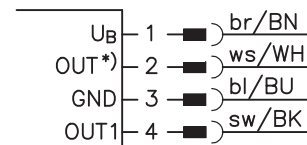

Transmitter, cable

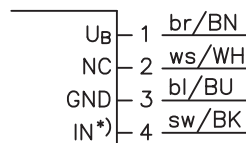

Receiver, cable

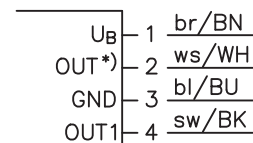

Selection pin 2/4

*)	OUT	IN
	OUT 2	Active
	Warn	NC
	NC	

We reserve the right to make changes • DS_L46C_en_50129626.fm

Specifications

Optical data

Typ. operating range limit ¹⁾	0 ... 150m
Operating range ²⁾	0.5 ... 120m
Operating range adjustment	225° potentiometer (LE46C.1... only)
Light source ³⁾	LED (modulated light)
Wavelength	630nm (visible red light)

Timing

Switching frequency	500Hz
Response time	1 ms
Delay before start-up	≤ 300ms

Electrical data

With transistor switching outputs

Operating voltage U_B ⁴⁾	10 ... 30VDC (incl. residual ripple)
Residual ripple	≤ 15% of U_B
Open-circuit current	≤ 20mA
Switching outputs/functions ⁵⁾	/4P 2 PNP switching outputs, antivalent
	/4X 1 PNP switching output, light switching
	/PX 1 PNP switching output, dark switching
	/2N 2 NPN switching outputs, antivalent
Signal voltage high/low	$\geq (U_B - 2V) \leq 2V$
Output current	max. 100mA

Indicators

Green LED	ready
Yellow LED	light path free
Yellow LED, flashing	light path free, no function reserve
Yellow LED (behind lens cover)	transmitter: active/not active
	receiver: signal/no signal
Yellow LED (behind lens cover), flashing	receiver: signal, function reserve limited

Mechanical data

Housing	plastic	
Optics cover	plastic	
Weight	with M12 connector: approx. 60g	
	with 200mm cable and M12 connector: approx. 65g	
	with 2000mm cable: approx. 100g	
Connection type	M12 connector, 4-pin	
	cable 200mm with M12 connector, 4-pin	
	cable 2000mm, 4 x 0.21 mm ²	

Environmental data

Ambient temp. (operation/storage)	-40°C ... +60°C/-40°C ... +70°C
Protective circuit ⁶⁾	1, 2, 3
VDE safety class ⁷⁾	II, all-insulated
Degree of protection	IP 67, IP 69K ⁸⁾
Light source	exempt group (in acc. with EN 62471)
Standards applied	IEC 60947-5-2
Certifications	UL 508, CSA C22.2 No.14-13 ^{4) 9)}

Options

Warning output

Signal voltage high/low	PNP transistor, counting principle
Output current	$\geq (U_B - 2V) \leq 2V$
	max. 100mA

Activation input

Transmitter active/not active	$\geq 8V \leq 2V$
Activation/disable delay	≤ 1ms
Input resistance	10KΩ ± 10%

- 1) Typ. operating range limit: max. attainable range without function reserve
- 2) Operating range: recommended range with function reserve
- 3) Average life expectancy 100,000 h at an ambient temperature of 25°C
- 4) For UL applications: for use in class 2 circuits only
- 5) See part number code
- 6) 1=transient protection, 2=polarity reversal protection, 3=short circuit protection for all outputs
- 7) Rating voltage 250VAC
- 8) IP 69K test acc. to DIN 40050 part 9 simulated, high pressure cleaning conditions without the use of additives, acids and bases are not part of the test
- 9) These proximity switches shall be used with UL Listed Cable assemblies rated 30V, 0.5A min, in the field installation, or equivalent (categories: CYJV/CYJV7 or PVVA/PVVA7)

Tables

0	0.5	120	150
---	-----	-----	-----

	Operating range [m]
	Typ. operating range limit [m]

Diagrams

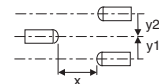
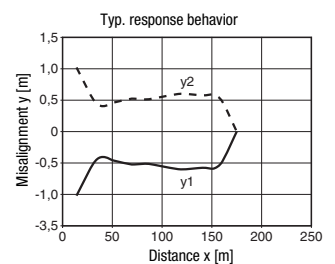

Remarks

Operate in accordance with intended use!

- ⚠ This product is not a safety sensor and is not intended as personnel protection.
- ⚠ The product may only be put into operation by competent persons.
- ⚠ Only use the product in accordance with the intended use.

- A light axis consists of a transmitter and a receiver with the following designations:

L46C... = complete light axis
 LS46C... = transmitter
 LE46C... = receiver

- Alignment indicator:

('B' see dimensioned drawing)
Yellow LED = light path free - with reserve
Yellow LED, flashing = light path free - no function reserve

L46C Red-light throughbeam photoelectric sensor with alignment display

Part number code

L	S	4	6	C	.	8				-	2	0	0	-	M	1	2
L	E	4	6	C	.	1	/	4	P	-	2	0	0	-	M	1	2

Operating principle

LS Throughbeam photoelectric sensor, transmitter
LE Throughbeam photoelectric sensor, receiver

Series

46C 46C series

Light type

Free Red light
I Infrared light

Equipment

1 Sensitivity adjustment via potentiometer on receiver
8 Activation input on transmitter (active high, connector pin 4/black cable wire)

Pin assignment of OUT1 (connector pin 4 / black cable wire)

2 NPN, light switching
N NPN, dark switching
4 PNP, light switching
P PNP, dark switching

Pin assignment of OUT2 (connector pin 2 / white cable wire)

X Not assigned
2 NPN, light switching
N NPN, dark switching
4 PNP, light switching
P PNP, dark switching
W Warning output, PNP light switching

Connection technology

M12 M12 connector, 4-pin
200-M12 Cable 200 mm with M12 connector, 4-pin
Free Cable 2000 mm

Order guide

The sensors listed here are preferred types; current information at www.leuze.com.

Red-light throughbeam photoelectric sensor with alignment display		Designation	Part no.
TRANSMITTER	With M12 connector, 4-pin		
	Standard	LS46C-M12	50127042
	With activation input	LS46C.8-M12	50127045
	Cable 0.2m with M12 connector, 4-pin		
	Standard	LS46C-200-M12	50127044
	Cable 2m		
	Standard	LS46C	50127043
RECEIVER	With M12 connector, 4-pin		
	OUT1: PNP light switching; OUT2: PNP dark switching	LE46C/4P-M12	50127033
	OUT1: PNP light switching; OUT2: warning output PNP active high	LE46C/4W-M12	50127038
	OUT1: PNP light switching; OUT2: PNP dark switching; sensitivity adjustment	LE46C.1/4P-M12	50127037
	OUT1: NPN light switching; OUT2: NPN dark switching	LE46C/2N-M12	50127036
	Cable 0.2m with M12 connector, 4-pin		
	OUT1: PNP light switching; OUT2: PNP dark switching	LE46C/4P-200-M12	50127035
	OUT1: PNP dark switching; OUT2: no contact ¹⁾	LE46C/PX-200-M12	50127039
	Cable 2m		
	OUT1: PNP light switching; OUT2: PNP dark switching	LE46C/4P	50127034

1) Direct connection to AS-i coupling modules possible

For a complete light axis, arbitrary combinations of the transmitters and receivers listed above are possible.