

Technical data sheet Light curtain transmitter

Part no.: 50131366

CSL505-T05-75-M8

Contents

- Technical data
- Dimensioned drawings
- Electrical connection
- Operation and display
- Suitable receivers
- Part number code
- Accessories



Figure can vary



Technical data

Basic data

Series	505
Operating principle	Throughbeam principle
Device type	Transmitter
Application	Precise object detection

Special version

Special version	Crossed-beam scanning
	Diagonal-beam scanning
	Parallel-beam scanning

Optical data

Operating range	Guaranteed operating range
Operating range	0.3 ... 5 m
Measurement field length	75 mm
Number of beams	16 Piece(s)
Beam spacing	5 mm
Light source	LED, Infrared
LED light wavelength	860 nm

Measurement data

Minimum object diameter	7.5 mm
-------------------------	--------

Electrical data

Protective circuit	Inductive protection
	Polarity reversal protection
	Short circuit protected

Performance data

Supply voltage U_B	18 ... 30 V, DC
----------------------	-----------------

Connection

Number of connections	1 Piece(s)
-----------------------	------------

Connection 1

Function	Deactivation input
	Voltage supply
Type of connection	Connector
Thread size	M8
Type	Male
Material	Metal
No. of pins	4 -pin
Encoding	A-coded

Mechanical data

Design	Cubic
Dimension (W x H x L)	12 mm x 160 mm x 58 mm
Housing material	Metal
Metal housing	Aluminum
Lens cover material	Plastic
Housing color	Silver
Type of fastening	Through-hole mounting

Operation and display

Type of display	LED
Number of LEDs	1 Piece(s)
Type of configuration	Software
	Via pin assignment

Environmental data

Ambient temperature, operation	-30 ... 50 °C
Ambient temperature, storage	-40 ... 65 °C

Certifications

Degree of protection	IP 65
Protection class	III

Classification

Customs tariff number	90314990
eCl@ss 5.1.4	27270910
eCl@ss 8.0	27270910
eCl@ss 9.0	27270910
eCl@ss 10.0	27270910
eCl@ss 11.0	27270910
ETIM 5.0	EC002549
ETIM 6.0	EC002549
ETIM 7.0	EC002549

Dimensioned drawings

All dimensions in millimeters

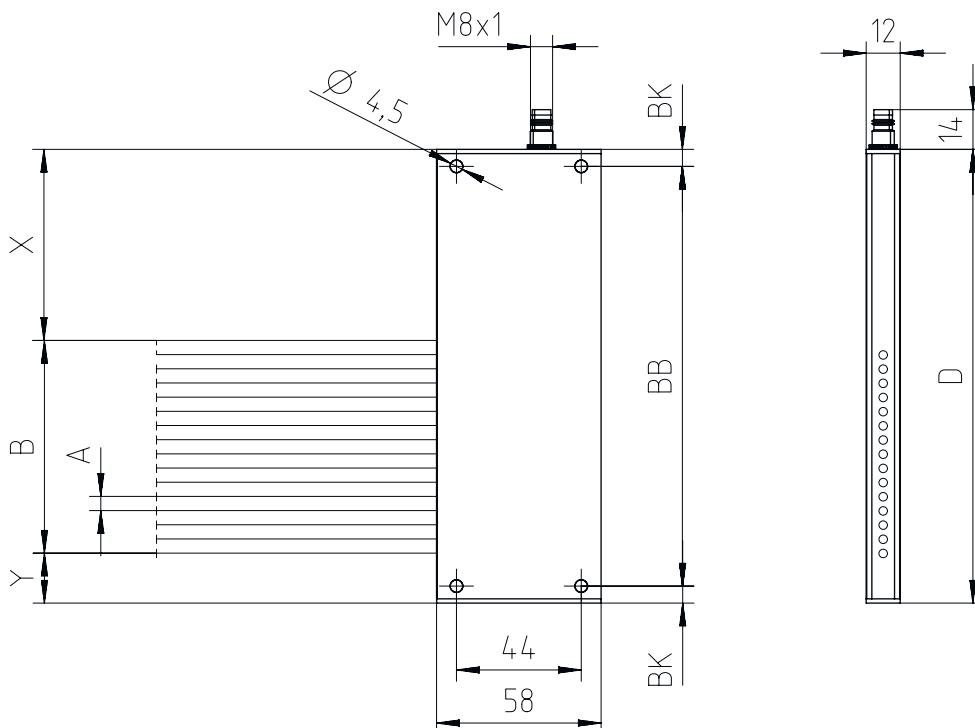

Electrical connection

Connection 1

Function	Deactivation input
	Voltage supply
Type of connection	Connector
Thread size	M8
Type	Male
Material	Metal
No. of pins	4 -pin
Encoding	A-coded

Pin	Pin assignment
1	V+
2	n.c.
3	GND
4	IN 1

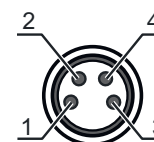

Operation and display

LED	Display	Meaning
1	Off	Off
	Red, continuous light	Operational readiness
	Red, flashing	Error

Suitable receivers

Part no.	Designation	Article	Description
50131309	CSL505-R05-75-M8	Light curtain receiver	Application: Precise object detection Special version: Parallel-beam scanning, Crossed-beam scanning, Diagonal-beam scanning, Teach input, Warning output Operating range: 0.3 ... 5 m Digital switching outputs: 2 Piece(s) Switching output: Transistor, Push-pull, Light/dark reversible Connection: Connector, M8, 4 -pin

Part number code

Part designation: **CSL505-YYYY-ZZZZ-AA-BBB**

X	Operating principle T: transmitter R: receiver
YYY	Beam spacing 05: 5 mm 12.5: 12.5 mm 25: 25 mm 50: 50 mm 100: 100 mm
ZZZZ	Measurement field length Measurement field length [mm], dependent on beam spacing
AA	Electrical connection M8: M8 connector, 4-pin (plug)

Note



A list with all available device types can be found on the Leuze website at www.leuze.com.

Accessories

Connection technology - Connection cables

Part no.	Designation	Article	Description
50130850	KD U-M8-4A-V1-050	Connection cable	Connection 1: Connector, M8, Axial, Female, 4 -pin Connection 2: Open end Shielded: No Cable length: 5,000 mm Sheathing material: PVC
50130871	KD U-M8-4W-V1-050	Connection cable	Connection 1: Connector, M8, Angled, Female, 4 -pin Connection 2: Open end Shielded: No Cable length: 5,000 mm Sheathing material: PVC

Configuration devices

Part no.	Designation	Article	Description
50132069	CSL505-Interface	Module	Connection: Sub-D Functions: Configuration and test device

Accessories

Note



🔗 A list with all available accessories can be found on the Leuze website in the Download tab of the article detailed page.