

## Technical data sheet Optical distance sensor

Part no.: 50113716

AMS 348i 300 H



Figure can vary

### Contents

- Technical data
- Dimensioned drawings
- Electrical connection
- Operation and display
- Part number code
- Notes
- Further information
- Accessories



CDRH



## Technical data

### Basic data

Series	AMS 300i
Application	Collision protection of cranes / gantry cranes Positioning of electroplating plants Positioning of high-bay storage devices Positioning of skilnet systems and side-tracking skates

### Functions

Functions	Heating
-----------	---------

### Characteristic parameters

MTTF	31 years
------	----------

### Optical data

Light source	Laser, Red
Laser class	2, IEC/EN 60825-1:2007

### Measurement data

Measurement range	200 ... 300,000 mm
Accuracy	5 mm
Reproducibility (3 sigma)	3 mm
Max. traverse rate	10 m/s

### Electrical data

Performance data	
Supply voltage $U_B$	18 ... 30 V, DC

### Interface

Type	PROFINET
Profinet	
Conformance class	B
Protocol	PROFINET RT
Switch functionality	Integrated
Transmission speed	100 Mbit/s

### Connection

Number of connections	4 Piece(s)
-----------------------	------------

Connection 1	
Function	BUS IN Data interface
Type of connection	Connector
Designation on device	BUS IN
Thread size	M12
Type	Female
No. of pins	4 -pin
Encoding	D-coded

### Connection 2

Function	BUS OUT Data interface
Type of connection	Connector
Designation on device	BUS OUT
Thread size	M12
Type	Female
No. of pins	4 -pin
Encoding	D-coded

### Connection 3

Function	PWR / SW IN / OUT Voltage supply
Type of connection	Connector
Designation on device	PWR
Thread size	M12
Type	Male
No. of pins	5 -pin
Encoding	A-coded

### Connection 4

Function	Service interface
Type of connection	Connector
Designation on device	SERVICE
Thread size	M12
Type	Female
No. of pins	5 -pin
Encoding	A-coded

### Mechanical data

Design	Cubic
Dimension (W x H x L)	84 mm x 166.5 mm x 159 mm
Housing material	Metal
Net weight	2,450 g
Type of fastening	Through-hole mounting

### Operation and display

Type of display	LC Display LED
Operational controls	Membrane keyboard

### Environmental data

Ambient temperature, operation	-30 ... 50 °C
Ambient temperature, storage	-30 ... 70 °C
Relative humidity (non-condensing)	90 %

### Certifications

Degree of protection	IP 65
Protection class	III
Certifications	c UL US

## Technical data

Customs tariff number	90318020
eCl@ss 5.1.4	27270801
eCl@ss 8.0	27270801
eCl@ss 9.0	27270801
eCl@ss 10.0	27270801
eCl@ss 11.0	27270801
ETIM 5.0	EC001825
ETIM 6.0	EC001825
ETIM 7.0	EC001825

# Dimensioned drawings

All dimensions in millimeters

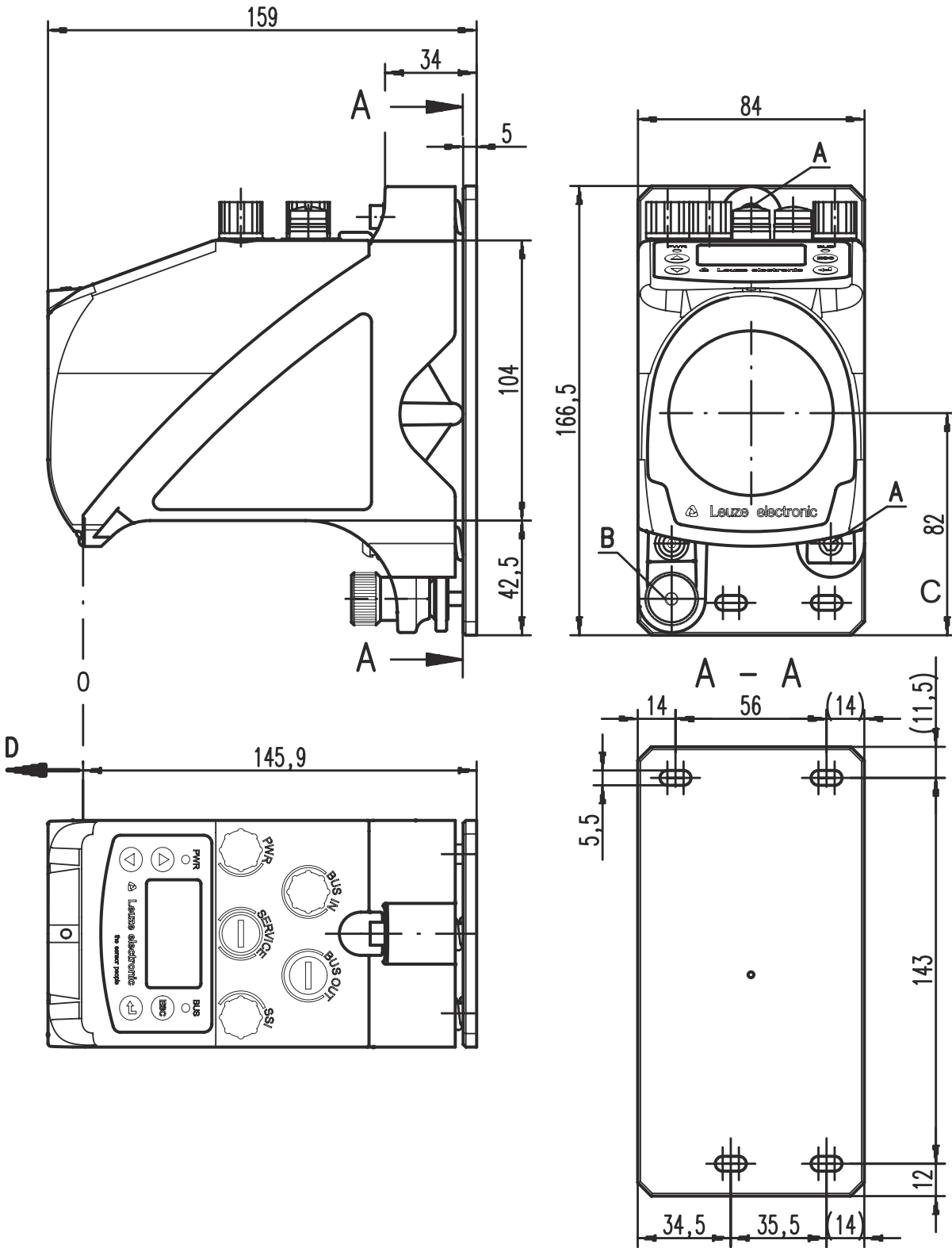

- A M5 screw for alignment
- B Knurled nut with WAF4 hexagon socket and M5 nut for securing
- C Optical axis
- D Zero point of the distance to be measured

## Electrical connection

### Connection 1

### BUS IN

Function	BUS IN Data interface
Type of connection	Connector
Thread size	M12
Type	Female
Material	Metal
No. of pins	4 -pin
Encoding	D-coded

Pin	Pin assignment
-----	----------------

1	TD+
2	RD+
3	TD-
4	RD-



### Connection 2

### BUS OUT

Function	BUS OUT Data interface
Type of connection	Connector
Thread size	M12
Type	Female
Material	Metal
No. of pins	4 -pin
Encoding	D-coded

Pin	Pin assignment
-----	----------------

1	TD+
2	RD+
3	TD-
4	RD-



### Connection 3

### PWR

Function	PWR / SW IN / OUT Voltage supply
Type of connection	Connector
Thread size	M12
Type	Male
Material	Metal
No. of pins	5 -pin
Encoding	A-coded

Pin	Pin assignment
-----	----------------

1	VIN
2	I/O 1
3	GND
4	I/O 2
5	FE



## Electrical connection

### Connection 4

### SERVICE

Function	Service interface
Type of connection	Connector
Thread size	M12
Type	Female
Material	Metal
No. of pins	5 -pin
Encoding	A-coded

### Pin Pin assignment

1	n.c.
2	RS 232-TX
3	GND
4	RS 232-RX
5	n.c.



## Operation and display

LED	Display	Meaning
1 PWR	Off	No supply voltage
	Green, flashing	Voltage connected / no measurement value output / initialization running
	Green, continuous light	Device OK, measurement value output
	Red, flashing	Device OK, warning set
	Red, continuous light	No measurement value output
	Orange, flashing	PROFINET wave function activated
	Orange, continuous light	Configuration via display
2 BUS	Off	No supply voltage
	Green, flashing	Device ok, initialization phase
	Green, continuous light	Device OK
	Red, flashing	Communication error
	Red, continuous light	Bus error
	Orange, flashing	PROFINET wave function activated
3 BUS IN	Green, continuous light	Link OK
	Orange, flashing	Data exchange active
4 BUS OUT	Green, continuous light	Link OK
	Orange, flashing	Data exchange active

## Part number code

Part designation: **AMS 3XXi YYY Z AAA**

<b>AMS</b>	<b>Operating principle</b> AMS: absolute measurement system
<b>3XXi</b>	<b>Series/interface (integrated fieldbus technology)</b> 300i: RS 422/RS 232 301i: RS 485 304i: PROFIBUS DP / SSI 308i: TCP/IP 335i: CANopen 338i: EtherCAT 348i: PROFINET RT 355i: DeviceNet 358i: EtherNet/IP 384i: Interbus

## Part number code

YYY	<b>Operating range</b> 40: max. operating range in m 120: max. operating range in m 200: max. operating range in m 300: max. operating range in m
Z	<b>Special equipment</b> H: with heating
AAA	<b>Interface</b> SSI: with SSI interface

### Note

	<ul style="list-style-type: none"> <li>A list with all available device types can be found on the Leuze website at <a href="http://www.leuze.com">www.leuze.com</a>.</li> </ul>
--	---

## Notes

### Observe intended use!

	<ul style="list-style-type: none"> <li>This product is not a safety sensor and is not intended as personnel protection.</li> <li>The product may only be put into operation by competent persons.</li> <li>Only use the product in accordance with its intended use.</li> </ul>
--	---

### WARNING! LASER RADIATION – CLASS 2 LASER PRODUCT

	<p><b>Do not stare into beam!</b> The device satisfies the requirements of IEC 60825-1:2007 (EN 60825-1:2007) safety regulations for a product of laser class 2 as well as the U.S. 21 CFR 1040.10 regulations with deviations corresponding to "Laser Notice No. 50" from June 24, 2007.</p> <ul style="list-style-type: none"> <li>Never look directly into the laser beam or in the direction of reflected laser beams! If you look into the beam path over a longer time period, there is a risk of injury to the retina.</li> <li>Do not point the laser beam of the device at persons!</li> <li>Interrupt the laser beam using a non-transparent, non-reflective object if the laser beam is accidentally directed towards a person.</li> <li>When mounting and aligning the device, avoid reflections of the laser beam off reflective surfaces!</li> <li>CAUTION! Use of controls or adjustments or performance of procedures other than specified herein may result in hazardous light exposure.</li> <li>Observe the applicable statutory and local laser protection regulations.</li> <li>The device must not be tampered with and must not be changed in any way. There are no user-serviceable parts inside the device. Repairs must only be performed by Leuze electronic GmbH + Co. KG.</li> </ul>
--	---

### NOTE



	<p><b>Affix laser information and warning signs!</b> Laser information and warning signs are affixed to the device. In addition, self-adhesive laser information and warning signs (stick-on labels) are supplied in several languages.</p> <ul style="list-style-type: none"> <li>Affix the laser information sheet to the device in the language appropriate for the place of use. When using the device in the US, use the stick-on label with the "Complies with 21 CFR 1040.10" note.</li> <li>Affix the laser information and warning signs near the device if no signs are attached to the device (e.g. because the device is too small) or if the attached laser information and warning signs are concealed due to the installation position.</li> <li>Affix the laser information and warning signs so that they are legible without exposing the reader to the laser radiation of the device or other optical radiation.</li> </ul>
--	--

## Further information



- For UL applications, use is only permitted in Class 2 circuits in accordance with the NEC (National Electric Code).
- Use as safety-related component within the safety function is possible, if the component combination is designed correspondingly by the machine manufacturer.

## Accessories

### Connection technology - Connection cables

	Part no.	Designation	Article	Description
	50104171	KB SSI/IBS-5000-BA	Connection cable	Suitable for interface: SSI, Interbus-S Connection 1: Connector, M12, Axial, Female, B-coded, 5 -pin Connection 2: Open end Shielded: Yes Cable length: 5,000 mm Sheathing material: PUR
	50132079	KD U-M12-5A-V1-050	Connection cable	Connection 1: Connector, M12, Axial, Female, A-coded, 5 -pin Connection 2: Open end Shielded: No Cable length: 5,000 mm Sheathing material: PVC
	50135074	KS ET-M12-4A-P7-050	Connection cable	Suitable for interface: Ethernet Connection 1: Connector, M12, Axial, Male, D-coded, 4 -pin Connection 2: Open end Shielded: Yes Cable length: 5,000 mm Sheathing material: PUR

### Reflective tapes for distance sensors

	Part no.	Designation	Article	Description
	50115022	Reflexfolie 914x914mm-H	Reflector	Special version: Heating Supply voltage: 230 V, AC Design: Rectangular Reflective surface: 914 mm x 914 mm Base material: Aluminum composite Fastening: Mounting plate, Through-hole mounting
	50108988	Reflexfolie 914x914mm-S	Reflective tape	Design: Rectangular Reflective surface: 914 mm x 914 mm Chemical designation of the material: PMMA Fastening: Adhesive

### Deflecting mirror

	Part no.	Designation	Article	Description
	50104479	US AMS 01	Deflecting mirror	Type of fastening: Through-hole mounting



## Accessories

### Services

	Part no.	Designation	Article	Description
	S981001	CS10-S-110	Start-up support	<p>Details: Performed at location of customer's choosing, duration: max. 10 hours.</p> <p>Conditions: Devices and connection cables are already mounted, price not including travel costs and, if applicable, accommodation expenses.</p> <p>Restrictions: No mechanical (mounting) and electrical (wiring) work performed, no changes (attachments, wiring, programming) to third-party components in the nearby environment.</p>
	S981005	CS10-T-110	Product training	<p>Details: Location and content to be agreed upon, duration: max. 10 hours.</p> <p>Conditions: Price not including travel costs and, if applicable, accommodation expenses.</p> <p>Restrictions: Travel costs and accommodation expenses charged separately and according to expenditure.</p>

#### Note



A list with all available accessories can be found on the Leuze website in the Download tab of the article detailed page.