



CR 100 Bar Code Reader



© 2015

Leuze electronic GmbH + Co. KG

In der Braike 1

D-73277 Owen / Germany

Phone: +49 7021 573-0

Fax: +49 7021 573-199

<http://www.leuze.com>

info@leuze.de

1	About this document	5
1.1	Used symbols and signal words	5
2	Safety	6
2.1	Intended use	6
2.2	Foreseeable misuse	6
2.3	Competent persons	6
2.4	Disclaimer	7
3	Device description	8
3.1	Device overview	8
3.1.1	The CR 100 bar code reader	8
3.1.2	Stand alone operation	8
3.2	Performance characteristics	8
3.3	Device construction	8
3.4	Connection technology	9
3.5	Display elements	9
3.5.1	LED indicators	9
4	Mounting	10
4.1	Selecting a mounting location	10
5	Electrical connection	11
5.1	Voltage supply	11
5.2	Pin assignment of the CR 100 connection cable	11
5.3	Switching input/Switching output	11
5.3.1	Switching input	11
5.3.2	Switching output	12
5.4	PC or terminal connection	13
5.5	Cable lengths and shielding	14
6	Configuration and diagnostic software - <i>Sensor Studio</i>	15
6.1	System requirements	15
6.2	Installing <i>Sensor Studio</i> configuration software	16
6.2.1	Downloading configuration software	16
6.2.2	Installing the <i>Sensor Studio</i> FDT frame	16
6.2.3	Intalling communication DTM and device DTM for CR 100	16
6.2.4	Connecting bar code reader to PC	17
6.3	Starting the <i>Sensor Studio</i>	17
6.4	Exiting <i>Sensor Studio</i>	19
6.5	Configuration parameters	19
6.5.1	Decode tab	20
6.5.2	Output tab	23
6.5.3	Control tab	25
6.5.4	Host interface tab	26
6.5.5	Reference code tab	28
6.5.6	Sensor tab	30
6.5.7	Switch tab	31
7	Starting up the device - Configuration	32
7.1	Measures to be performed prior to the initial commissioning	32
7.2	Starting the device	32
7.2.1	“Power On” test	32

7.2.2	Interface	32
7.2.3	“Online commands”	32
7.2.4	Problems	32
7.3	Setting the communication parameters	32
7.3.1	Parameter sets	33
7.3.2	“Service” operating mode	33
8	Online commands	34
8.1	Overview of commands and parameters	34
8.2	General online commands	34
8.3	Online commands for system control	38
8.4	Online commands for the parameter set operations	39
9	Care, maintenance and disposal	43
9.1	Cleaning	43
9.2	Servicing	43
9.3	Disposing	43
10	Diagnostics and troubleshooting	44
11	Service and support	45
11.1	What to do should servicing be required?	45
12	Technical data	46
12.1	General specifications	46
12.2	Reading fields	47
12.3	Dimensioned drawings	48
13	Ordering information and accessories	50
13.1	Type overview	50
13.2	Accessories	50
14	EC Declaration of Conformity	51
15	Appendix	52
15.1	Bar code samples	52

1 About this document

1.1 Used symbols and signal words

Table 1.1: Warning symbols and signal words

	Symbol indicating dangers to persons
NOTICE	Signal word for property damage Indicates dangers that may result in property damage if the measures for danger avoidance are not followed.

Table 1.2: Other symbols



	Symbol for tips Text passages with this symbol provide you with further information.
	Symbols for action steps Text passages with this symbol instruct you to perform actions.

Table 1.3: Terms and abbreviations

BCL	Bar code reader
CR	CCD based bar code reader (Code Reader)
DTM	Software device manager (Device Type Manager)
EMC	Electromagnetic compatibility
EN	European standard
FDT	Software frame for management of device managers (DTM) (Field Device Tool)
FE	Functional earth
GUI	Graphical User Interface
IO or I/O	Input/Output
LED	Light Emitting Diode
PLC	Programmable Logic Control

2 Safety

This sensor was developed, manufactured and tested in line with the applicable safety standards. It corresponds to the state of the art.

2.1 Intended use

The CR 100 bar code reader is designed as a stationary scanner with integrated decoder for all common bar codes used for automatic object detection.

Areas of application

The CR 100 bar code reader is intended especially for the following areas of application:

- automatic analyzers
- space-critical bar code reading tasks
- automation technology

NOTICE
<p>Comply with conditions and regulations!</p> <p>↳ Observe the locally applicable legal regulations and the rules of the employer's liability insurance association.</p>

2.2 Foreseeable misuse

Any use other than that defined under “Intended use” or which goes beyond that use is considered improper use.

In particular, use of the device is not permitted in the following cases:

- Rooms with explosive atmospheres
- Circuits relevant to safety
- Operation for medical purposes

NOTICE
<p>Do not modify or otherwise interfere with the device.</p> <p>↳ Do not carry out modifications or otherwise interfere with the device.</p> <p>The device must not be tampered with and must not be changed in any way.</p> <p>The device must not be opened. There are no user-serviceable parts inside.</p> <p>Repairs must only be performed by Leuze electronic GmbH + Co. KG.</p>

2.3 Competent persons

Connection, mounting, commissioning and adjustment of the device must only be carried out by competent persons.

Prerequisites for competent persons:

- They have a suitable technical education.
- They are familiar with the rules and regulations for occupational safety and safety at work.
- They are familiar with the technical description of the device.
- They have been instructed by the responsible person on the mounting and operation of the device.

Certified electricians

Electrical work must be carried out by a certified electrician.

Due to their technical training, knowledge and experience as well as their familiarity with relevant standards and regulations, certified electricians are able to perform work on electrical systems and independently detect possible dangers.

In Germany, certified electricians must fulfill the requirements of accident-prevention regulations BGV A3 (e.g. electrician foreman). In other countries, there are respective regulations that must be observed.

2.4 Disclaimer

Leuze electronic GmbH + Co. KG is not liable in the following cases:

- The device is not being used properly.
- Reasonably foreseeable misuse is not taken into account.
- Mounting and electrical connection are not properly performed.
- Changes (e.g., constructional) are made to the device.

3 Device description

3.1 Device overview

3.1.1 The CR 100 bar code reader

The CR 100 bar code reader is a CCD based line scanner with integrated decoder for all commonly used bar codes, e.g. 2/5 Interleaved, Code 39, Code 128, EAN etc..

The many possible configurations of the device allow it to be adapted to a multitude of reading tasks. Due to the small dimensions of the unit and its wide reading field, the CR 100 may also be used in highly constrained spaces.

Information on technical data and characteristics: see chapter 12.

3.1.2 Stand alone operation

The CR 100 bar code reader is operated as a “standalone” single device. It is equipped with a six-wire cable with open ends for the electrical connection of the supply voltage, the interface, the switching input and the switching output.

3.2 Performance characteristics

- High-performance CCD scanner with front or lateral beam exit
- Reading field optimized to a reading field height of 80 mm even at short distances
- Compact design for simple integration, even in constrained spaces
- Scanning rate of 700 scans/s facilitates reliable reading, even while in motion
- Reading of all common codes of modulus sizes 150 – 500 µm (6-20 mil) at a reading field height of ≥ 80 mm
- Robust metal housing with cable connection
- RS 232 interface, one switching input, one switching output

3.3 Device construction

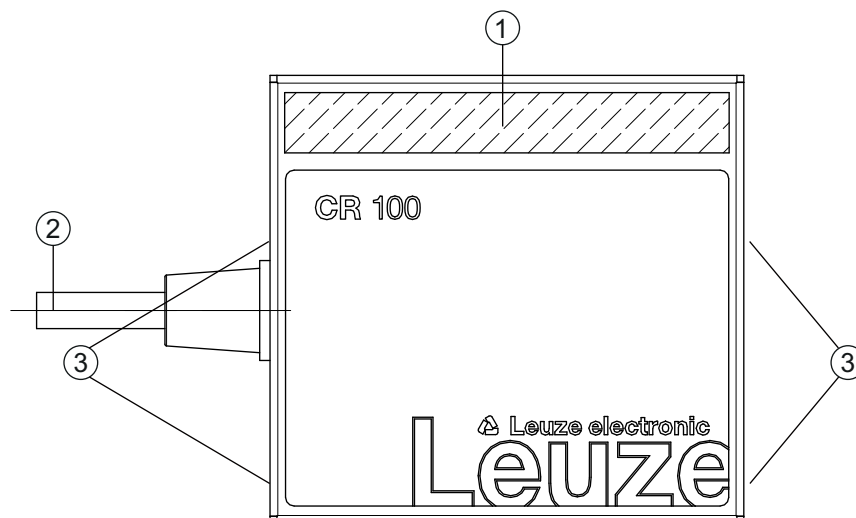

- 1 Reading window with lateral beam exit
- 2 Cable, 2000 mm
- 3 M3 mounting thread

Figure 3.1: CR 100M0 device construction

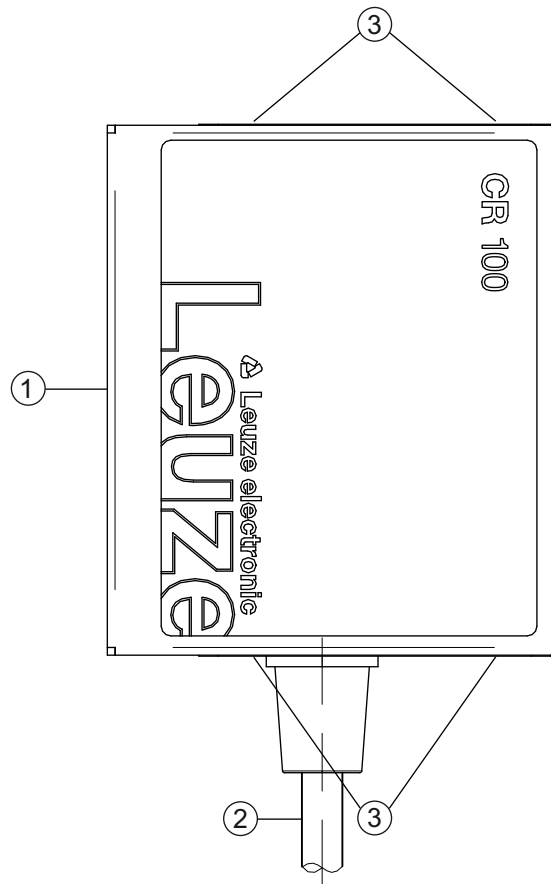

- 1 Reading window with front beam exit
- 2 Cable, 2000 mm
- 3 M3 mounting thread

Figure 3.2: CR 100M2 device construction

3.4 Connection technology

- Cable connection
- Alternative: customer-specific solutions

3.5 Display elements

On the rear of the CR 100, you will find an LED that indicates the readiness for operation and the read status of the bar code reader.

3.5.1 LED indicators

A 3-color LED on the rear of the housing indicates the device and read status:

Table 3.1: LED indicators

Color	State	Description
Orange	ON (continuous light)	Reading gate active
	Flashing	Initialization phase
Green	ON (continuous light)	Reading successful
Red	ON (continuous light)	No read result

4 Mounting

You can fasten the CR 100 at the M3 mounting threads on both sides of the device.

4.1 Selecting a mounting location



The size of the bar code module influences the maximum reading distance and the width of the reading field. Therefore, when selecting a mounting location and/or the bar code label, take into account the different reading characteristics of the scanner with various bar code modules.

NOTICE

Observe when choosing the mounting location!

- ↳ Maintaining the required environmental conditions (temperature, humidity).
- ↳ Possible soiling of the reading window due to liquids, abrasion by boxes, or packaging material residues.
- ↳ Lowest possible chance of damage to the scanner by mechanical collision or jammed parts.
- ↳ Possible extraneous light influence (no direct sunlight).

In order to select the right mounting location, several factors must be considered:

- size, orientation, and position tolerance of the bar codes on the objects to be scanned.
- the reading field of the CR 100 in relation to the bar code module width.
- the CR 100 is designed for reading codes in ladder orientation.
- the resulting minimum and maximum reading distance from the respective reading field; see figure 12.2.
- alignment of the bar code reader for avoiding reflections.
- distance between CR 100 and host system with respect to the interface.

The best read results are obtained when

- the reading distance lies in the middle area of the reading field.
- there is no direct sunlight and extraneous light is avoided.
- the bar code labels are of good print quality and have good contrast ratios.
- you do not use high-gloss labels.
- the bar code is moved past the reading window with a rotational angle of 10° to 15°.
- the red light beam is narrowed down for its respective reading task in order to avoid reflections on shiny components.



With front beam exit, the beam exit on the CR 100 is nearly vertical to the reading window; with lateral beam exit, the beam exit is at 13° from vertical. The bar code label must be rotated by > 10° to avoid a total reflection of the red light beam in the case of glossy labels.

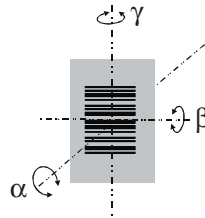

- α Azimuth angle
 - β Angle of inclination
 - γ Angle of rotation
- Recommended angle of rotation: $\gamma > 10^\circ$

Figure 4.1: Definition of the CR 100 reading angles

5 Electrical connection

 **CAUTION**

Safety notices

- ↳ The CR 100 bar code reader is completely sealed and must not be opened.
- ↳ Do not try to open the device under any circumstances, as this voids both degree of protection IP 40 and the warranty.
- ↳ Before connecting the device, be sure that the supply voltage agrees with the value printed on the name plate.
- ↳ Connection of the device and maintenance work while under voltage must only be carried out by a qualified electrician.
- ↳ The power supply unit for the generation of the supply voltage for the CR 100 and the corresponding connection units must have a secure electrical insulation according to IEC 60742 (PELV). For UL applications: only for use in "class 2" circuits according to NEC.
- ↳ If faults cannot be corrected, the device should be removed from operation and protected against possible commissioning.

5.1 Voltage supply

The CR 100 bar code reader is designed for connection to a 5 V supply voltage.

- +5 V DC (red)
- GND (violet)

Available as an accessory is an adapter circuit board with spring terminals and 9-pin SUB-D socket; see chapter 13.2 "Accessories".

- With the adapter circuit board, the conductors of the CR 100 connection cable can be contacted via the spring terminals and connected to the PC via the 9-pin SUB-D socket with an RS 232 interconnection cable.
- With the adapter circuit board, the voltage supply from 10 ... 30 V DC can be fed in via spring terminals or, alternatively, 5 V DC can be fed in via a micro USB connector.

5.2 Pin assignment of the CR 100 connection cable

Wire	Assignment	Description	
Red	+5V DC	Operating voltage 5V DC	IN
Violet	GND	Operating voltage 0V DC / reference ground	IN
Black	SW OUT	Switching output	OUT
Orange	SW IN	Switching input	IN
White	RS 232 RxD	RxD signal line of the RS 232 interface	IN
Green	RS 232 TxD	TxD signal line of the RS 232 interface	OUT

5.3 Switching input/Switching output

The CR 100 is provided with a switching input **and** a switching output. You can configure the functions of the switching input or switching output according to your needs via the *Sensor Studio* configuration software; see chapter 6.

5.3.1 Switching input

By means of the SW IN switching input connection, you can trigger a read process in the **standard setting** (low = active) with the connection SW IN (orange) and GND (violet). The 2.2 kΩ "pull-up" resistor must be connected externally; see figure 5.1.

Depending on how the switching input is actuated, you can operate it both as NPN (low = active) as well as PNP (high = active).

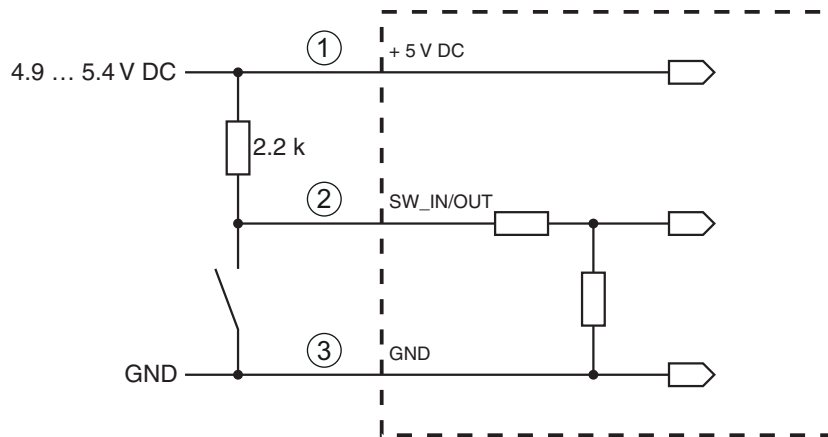

- 1 Red
- 2 Orange
- 3 Violet

Connection version **NPN**: standard setting (low = active); input resistance: 36 kΩ

Figure 5.1: Switching input for CR 100 connection version NPN (standard setting)

PNP actuation: With the **"inverted" setting** (high = active), you can trigger a read process by applying a voltage of +5 V DC (red) at SW IN (orange) (see figure 5.2).

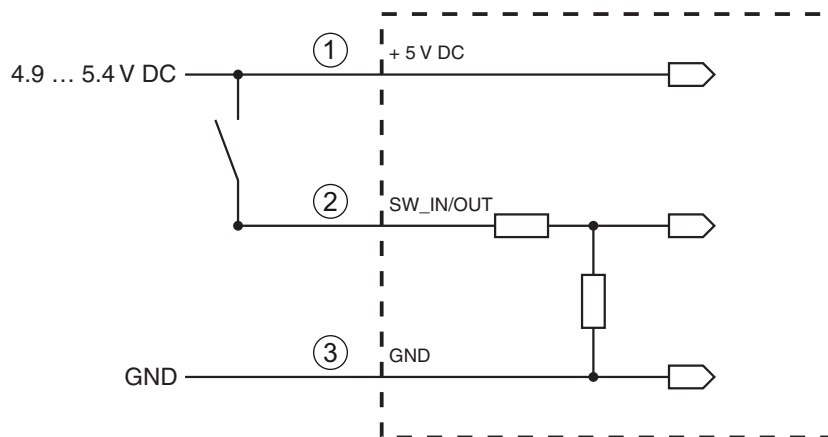

- 1 Red
- 2 Orange
- 3 Violet

Connection version **PNP**: "inverted" setting (high = active); input resistance: 36 kΩ

Figure 5.2: Switching input for CR 100 connection version PNP (setting "inverted")

5.3.2 Switching output

The NPN switching output connection between SW OUT (black) and GND (violet) can be activated in the scanner setup.

In the basic setting, the SW OUT switching output is switched to GND if a code is detected.

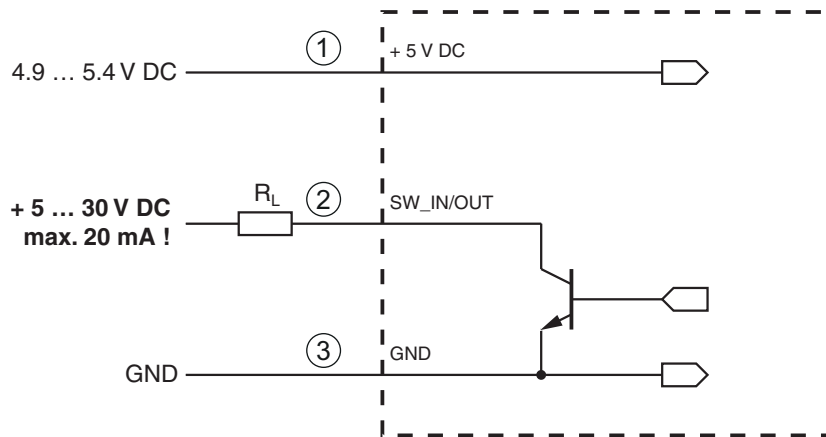

- 1 Red
- 2 Orange
- 3 Violet

Figure 5.3: Switching output CR 100

NOTICE
Maximum loading of the switching output
⚠ Do not load the switching output of the CR 100 with more than 20 mA at +5 ... 30V DC!

5.4 PC or terminal connection

Via the serial interface, you can configure the CR 100 by means of a PC or terminal. For this, you need an RS 232 connection that establishes the RxD, TxD and GND connections between PC and CR 100.

The RS 232 connection can be established in the following ways:

- Direct connection of the CR 100 connection wires to the PC or terminal via its own connector.
- Connection via an MA-CR adapter circuit board
 To simplify the connection of the connection wires to the PC interface, an adapter circuit board (MA-CR) is available for implementing individual wire contacting to SUB-D, 9-pin; see chapter 13.2.

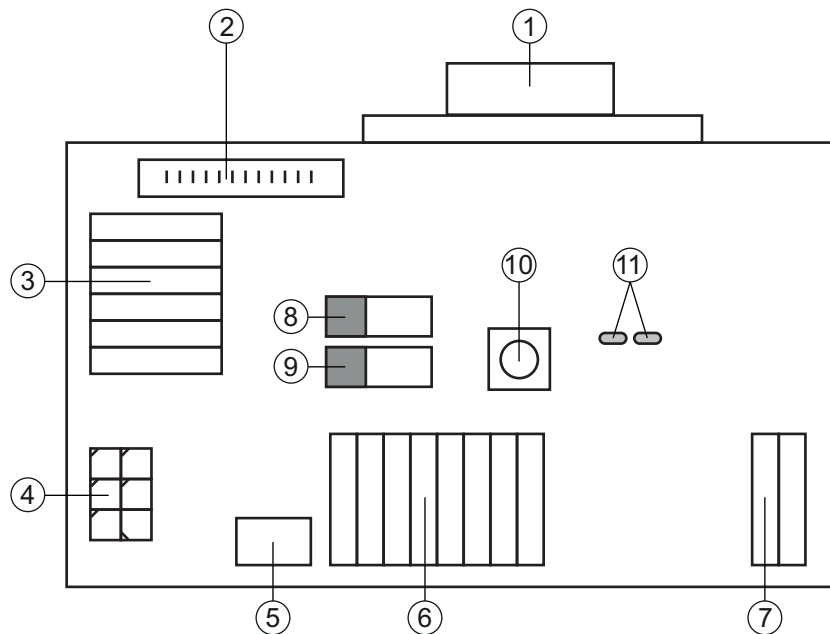

- 1 RS 232 connection
- 2 CR 50 connection
- 3 CR 100 or CR 55 connection
- 4 Molex Micro-Fit, 6-pin
- 5 USB connection
- 6 Connection to machine control, PLC, external voltage supply 5 VDC
- 7 External voltage supply 10 ... 30 VDC
- 8 SWIN DIP switch (level for trigger button; 5 V if the scanner high switching input is active, GND if the low input is active)
- 9 USB/PWR DIP switch (USB position if voltage is supplied via USB; PWR position if voltage is supplied via (7))
- 10 Trigger button
- 11 Status LEDs

Figure 5.4: Connection options for MA-CR adapter circuit board

5.5 Cable lengths and shielding

The maximum cable length is 3 m.

Should a cable extension be necessary, make certain that the cables of the RS 232 interface are shielded.

6 Configuration and diagnostic software - *Sensor Studio*

The *Sensor Studio* configuration software provides a graphical user interface for the operation, configuration and diagnosis of the device via the RS 232 interface.

A device that is not connected to the PC can be configured offline.

Configurations can be saved and reopened as projects for transferring back to the device at a later time.



Only use the *Sensor Studio* configuration software for products manufactured by **Leuze electronic**.

The *Sensor Studio* configuration software is offered in the following languages: German, English, French, Italian and Spanish.

The FDT frame application of the *Sensor Studio* supports all languages; all languages may not be supported in the device DTM (Device Type Manager).

The *Sensor Studio* configuration software is designed according to the FDT/DTM concept:

- You make the individual configuration settings for the CR 100 bar code reader in the Device Type Manager (DTM).
- The individual DTM configurations of a project can be called up via the frame application of the Field Device Tool (FDT).
- Communication DTM for bar code readers: *LeCommInterface*
- Device DTM for bar code readers CR 100

Procedure for the installation of the software and hardware:

↗ Install the *Sensor Studio* configuration software on the PC.

↗ Install the communication and device DTM.

Communication and device DTM are included in the *LeAnalysisCollectionSetup* installation package.

↗ Create CR 100-DTM in the project tree of the *Sensor Studio* FDT frame.

↗ Connect the CR 100 to the PC; see chapter 5.4

↗ Activate the service interface on the CR 100; see chapter 7.3.2

6.1 System requirements

To use the *Sensor Studio* configuration software, you need a PC or laptop with the following specifications:

Table 6.1: *System requirements for Sensor Studio* installation

Operating system	Windows XP or higher (32 bit, 64 bit) Windows Vista Windows 7 Windows 8
Computer	<ul style="list-style-type: none"> • Processor type: 1 GHz or higher • Serial COM interface • CD drive • Main memory (RAM): at least 64 MB • Keyboard and mouse or touchpad
Graphics card	At least 1024 x 768 pixels
Required hard disk capacity for <i>Sensor Studio</i> and communication DTM	35 MB



Administrator privileges on the PC are necessary for installing *Sensor Studio*.

6.2 Installing *Sensor Studio* configuration software



The installation files of the *Sensor Studio* configuration software must be downloaded from the Internet at www.leuze.com.

For subsequent updates, you can find the most recent version of the *Sensor Studio* installation software on the Internet at www.leuze.com.

6.2.1 Downloading configuration software

- ↵ Call up the Leuze home page: www.leuze.com
- ↵ Enter the type designation or part number of the device as the search term.
- ↵ The configuration software can be found on the product page for the device under the *Downloads* tab.

6.2.2 Installing the *Sensor Studio* FDT frame

NOTICE
<p>First install the software!</p> <p>↵ Do not yet connect the device to the PC. First install the software.</p>



If FDT frame software is already installed on your PC, you do not need the *Sensor Studio* installation.

You can install the communication DTM and the device DTM in the existing FDT frame. Communication DTM and device DTM are included in the *LeAnalysisCollectionSetup* installation package.

- ↵ Start the PC.
 - ↵ Download the configuration software from the Internet to the PC; see chapter 6.2.1.
Unpack the installation package.
 - ↵ Start the *SensorStudioSetup.exe* file.
 - ↵ Follow the instructions on the screen.
- The Installation Wizard installs the software and places a shortcut on the desktop ().

6.2.3 Installing communication DTM and device DTM for CR 100

Prerequisites:

- An FDT frame is installed on the PC.

- ↵ Start the *LeAnalysisCollection.exe* file from the installation package and follow the instructions on the screen.

The Installation Wizard installs communication DTM and device DTM for CR 100.

6.2.4 Connecting bar code reader to PC

The bar code reader is connected to the PC via the RS 232 interface. For this, you need an RS 232 connection that establishes the RxD, TxD and GND connections between PC and CR 100; see chapter 5.4.

- You need an RS 232 connection that establishes the RxD, TxD and GND connections between PC and CR 100; see chapter 5.4.
- The 5 V DC voltage supply is to be fed in externally; see chapter 5.1.



The MA-CR adapter circuit board with spring terminals for connecting the CR 100, as well as 9-pin SUB-D socket for connecting an RS 232 interconnection cable, is available as an accessory. An RS 232 interconnection cable to the PC is also available as an accessory; see chapter 13 "Ordering information and accessories".

The adapter circuit board requires 10 V ... 30 V DC as external voltage supply, which can be fed in via spring terminals. Alternatively, 5 V DC can be fed in via a micro USB connector.

6.3 Starting the *Sensor Studio*

configuration software

Prerequisites:

- The CR 100 bar code reader has been mounted (see chapter 4) and connected (see chapter 5) correctly.
- The CR 100 bar code reader is connected to the PC via the RS 232 interface (see chapter 6.2.4).
- The service interface is activated on the CR 100 bar code reader; see chapter 7.3.2
- The *Sensor Studio* configuration software is installed on the PC (see chapter 6.2 "Installing Sensor Studio configuration software").

☞ Start the *Sensor Studio* configuration software by double-clicking the *Sensor Studio* icon ().

The **mode selection** of the **Project Wizard** is displayed.

☞ Select the **Device selection without communication connection (offline)** configuration mode and click on [Next].

The **Project Wizard** displays the **device selection** list of the configurable devices.

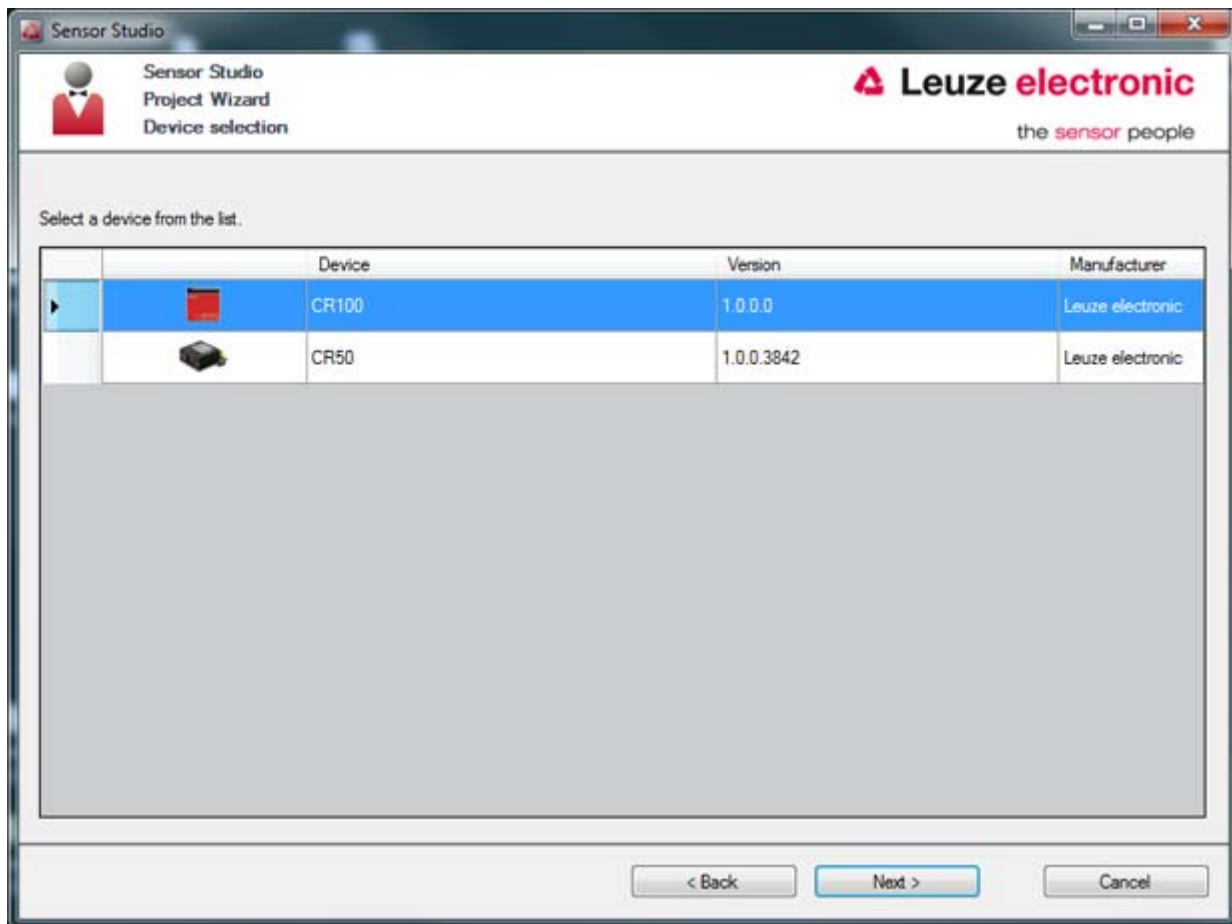



Figure 6.1: Device selection for bar code reader CR 100

☞ Select **CR 100** in the **device selection** and click on [Next].

The device manager (DTM) of the connected CR 100 starts with the offline view for the *Sensor Studio* configuration project.

☞ Establish the online connection to the connected CR 100.

In the *Sensor Studio* FDT frame, click on the [Establish connection with device] button ().

In the *Sensor Studio* FDT frame, click on the [Upload parameters to device] button ().

The current configuration data is displayed in the device manager (DTM).

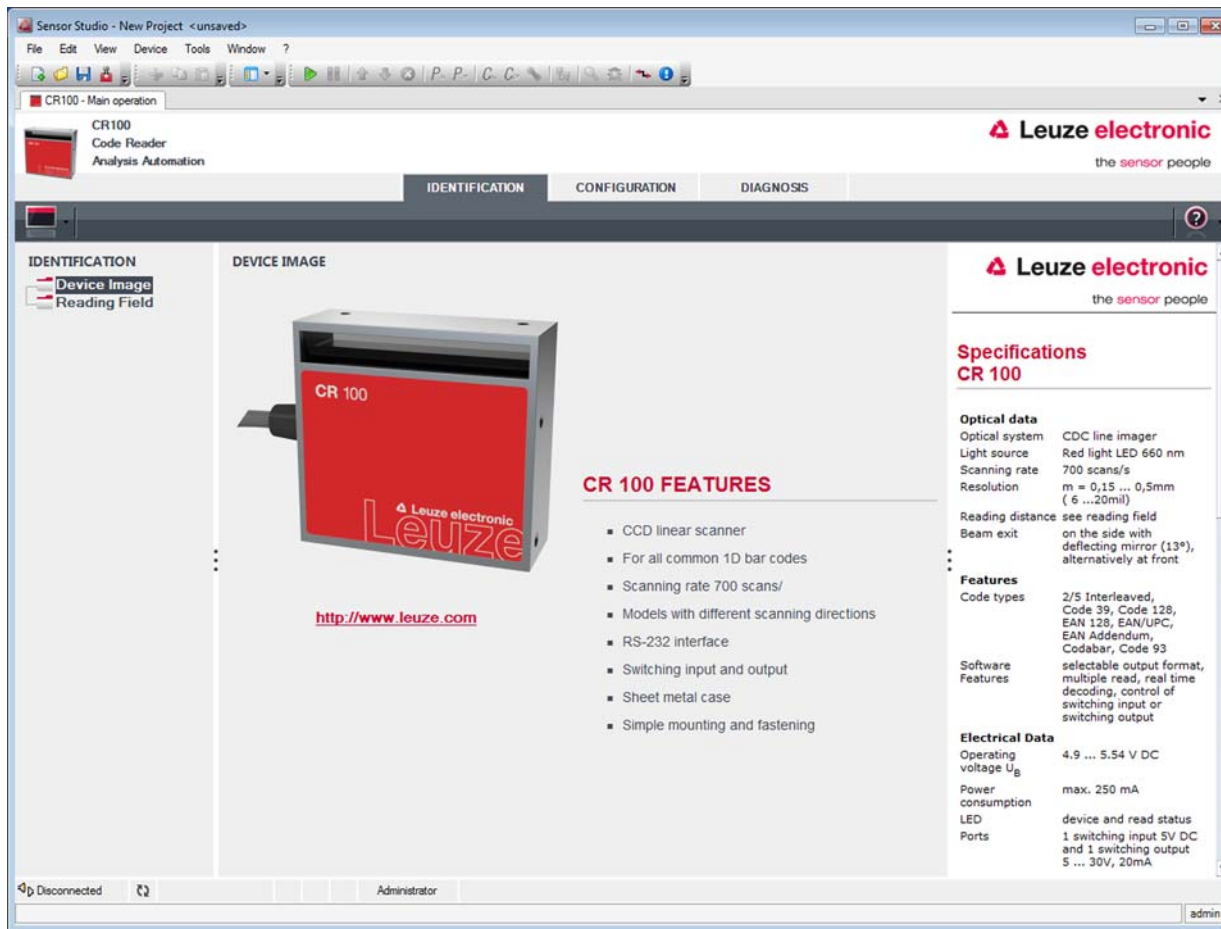



Figure 6.2: Configuration project: *Sensor Studio* device manager (DTM) for CR 100

↪ The menus of the *Sensor Studio* device manager (DTM) can be used to change or read out the configuration of the connected CR 100.

The user interface of the *Sensor Studio* device manager (DTM) is largely self-explanatory.

The online help system provides information on the menu items and adjustment parameters. Select the **Help** menu item in the menu [?] ().

↪ Transfer the modified configuration parameters to the device.

If a connection exists, click on the [Download parameters to device] button () on the task bar.

6.4 Exiting *Sensor Studio*

After completing the configuration settings, close the *Sensor Studio* configuration software

↪ Exit the program via **File > Exit**.

↪ Save the configuration settings as a configuration project on the PC.

You can open the configuration project again at later time via **File > Open** or with the *Sensor Studio* Project Wizard ().

6.5 Configuration parameters

In this chapter, you will find information and explanations on the configuration parameters of the device manager (DTM) for the CR 100 bar code reader.



This chapter does not include a complete description of the *Sensor Studio* configuration software.

Complete information on the FDT frame menu and on the functions in the device manager (DTM) can be found in the online help system.

The device manager (DTM) for CR 100 bar code readers of the *Sensor Studio* configuration software offers the following configuration functions:

- *Decode*; see chapter 6.5.1
- *Output*; see chapter 6.5.2
- *Control*; see chapter 6.5.3
- *Host Interface*; see chapter 6.5.4
- *Reference Code*; see chapter 6.5.5
- *Sensor*; see chapter 6.5.6
- *Switch*; see chapter 6.5.7



The online help system displays information on the menu items and configuration parameters for each function. Select the **Help** menu item in the menu [?]

6.5.1 Decode tab

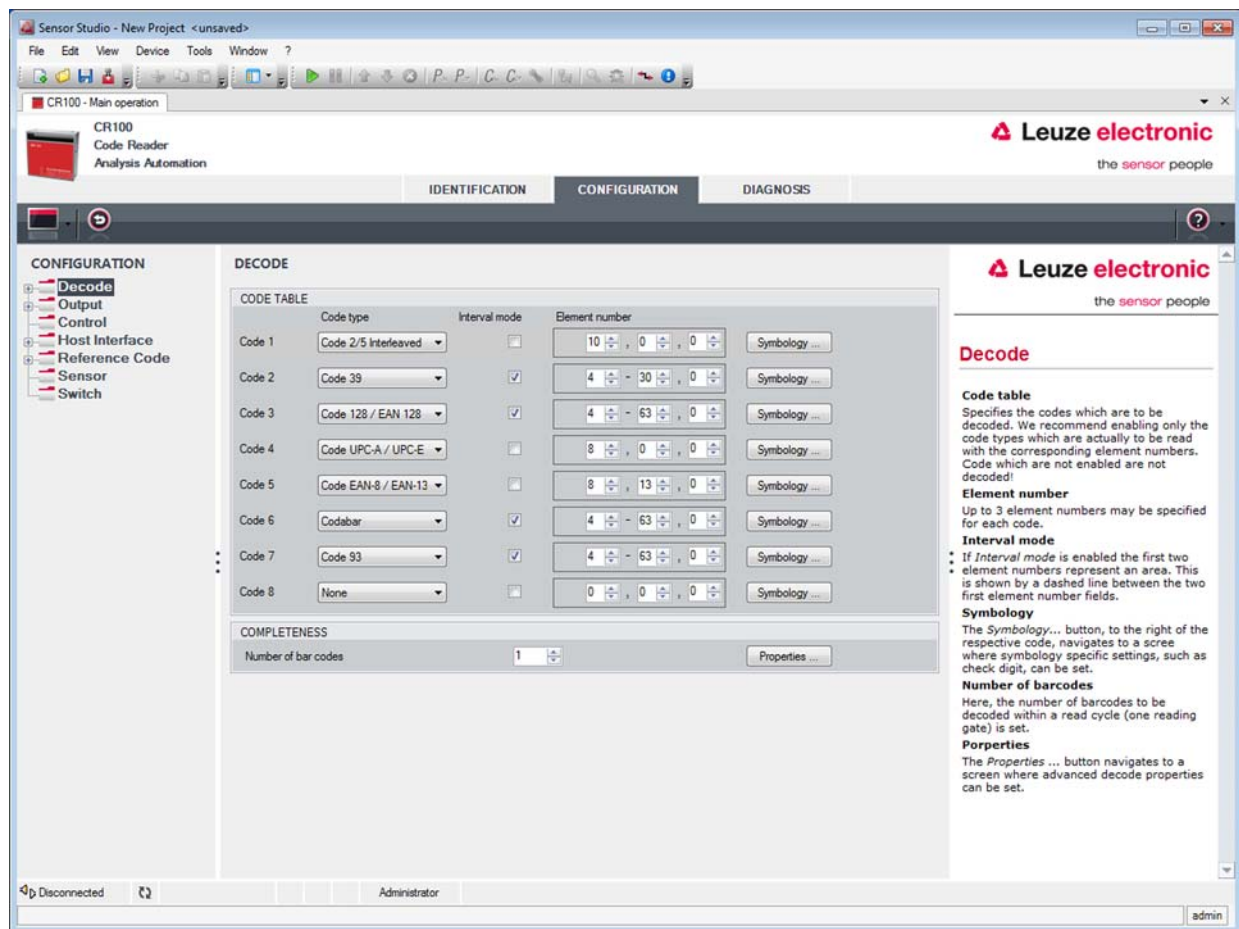

Figure 6.3: Decode tab

CODE TABLE

Here, the codes which are to be decoded are set. We recommend enabling only the code types which are to actually be read with the corresponding element numbers. Codes which are not enabled are not decoded!

Element number

In the field Element number, up to 3 element entries may be entered. A range of permissible elements is indicated by a dash: e.g., 4-40 elements. To select a range, set the checkmark under **Interval mode**. Up to three fixed element numbers with comma: e.g.: 8,13 elements. Both are also possible, but first the range must be specified (select **Interval mode**): e.g.: 4-10,20 elements.

Number of bar codes (COMPLETENESS)

Here, the number of the bar codes to be decoded within a read cycle (one reading gate) is set.



If the code EAN128 is to be read, 3 additional characters are to be set for the code identifier.

Properties (Symbologies)

In the “Symbology Properties” window to the right of the respective code, after **Element number**, the code-specific settings such as the check digit can be selected. Alternatively, the property settings can be selected directly via the navigation tree under the Symbologies button. The properties can be individually set for each **code type**.

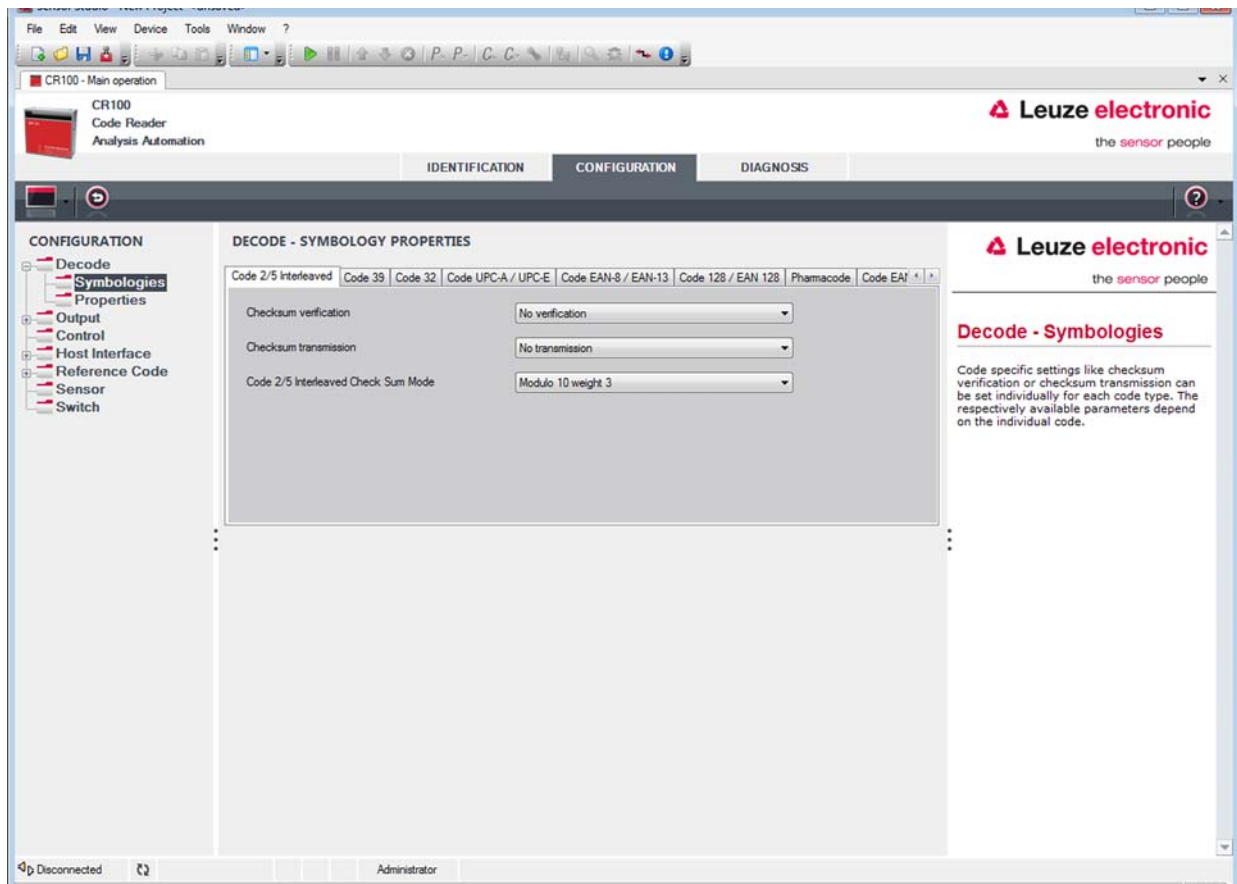

Figure 6.4: Standard settings for the Properties window (Symbology Properties) – Decode tab

Properties window – Decode tab

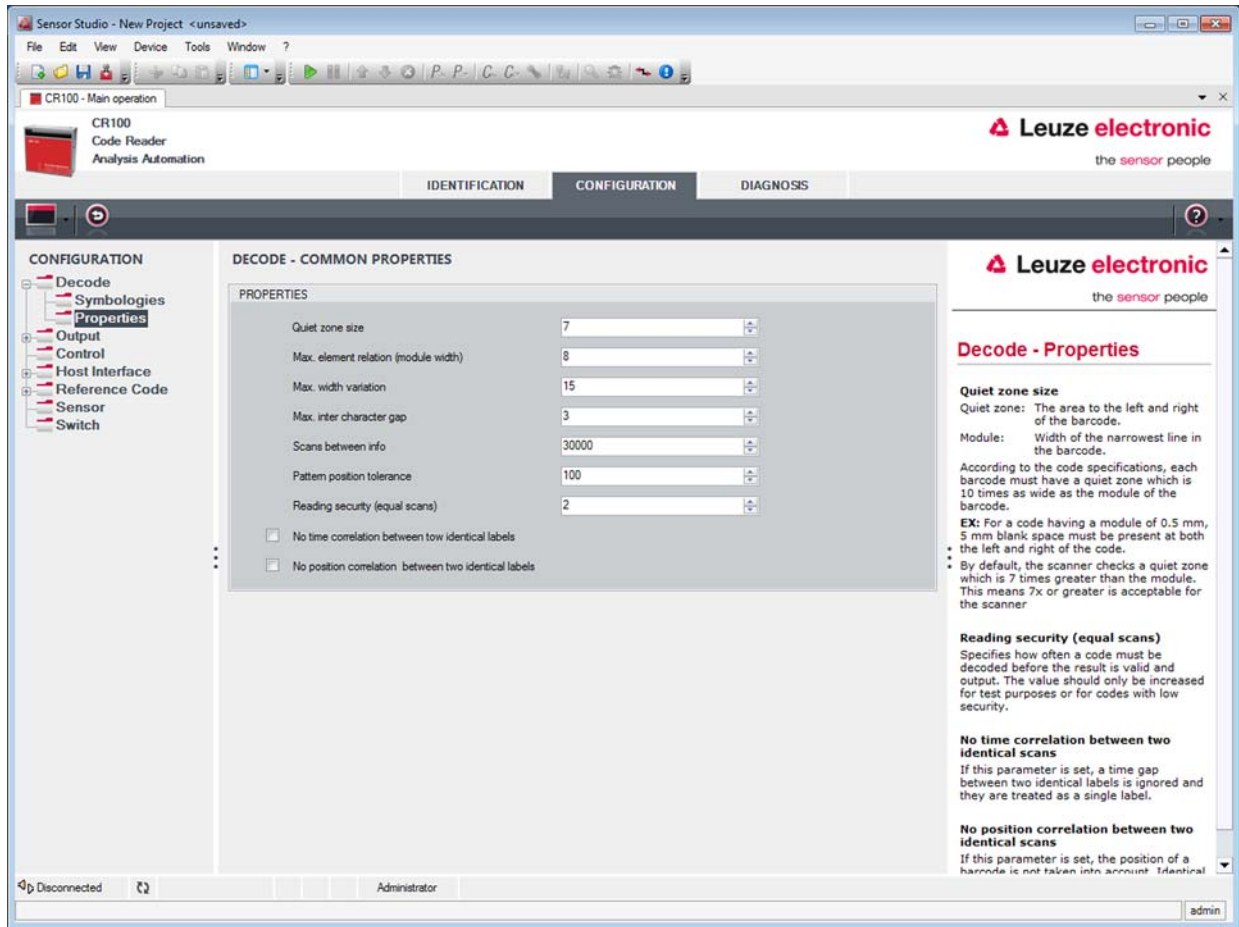

Figure 6.5: Standard settings for the Properties window – Decode tab

- Quiet zone size** Quiet zone: The area to the left and right of the bar code
 Module: width of the narrowest bar in the bar code
 According to code specifications, each bar code must have a quiet zone that is 10x as wide as the module of the bar code.
 Example: For a code with a module of 0.5 mm, there must be 5 mm of empty space to the left and right.
 By default, the scanner checks a quiet zone that is 7x greater than the module.
 This means 7x or greater is acceptable for the scanner.
- Equal scans** Specifies how often a code must be decoded before the result is valid and output.
- No time correlation between two identical labels** If this parameter is set, a gap between two identical labels is ignored and they are treated as a single label.
- No position correlation between two identical labels** If this parameter is set, then the position of a bar code label in the reading beam is not taken into account. Identical labels are treated as a single label.



In general, the remaining parameters must not be changed. In the worst case, this could corrupt the reading result!

6.5.2 Output tab

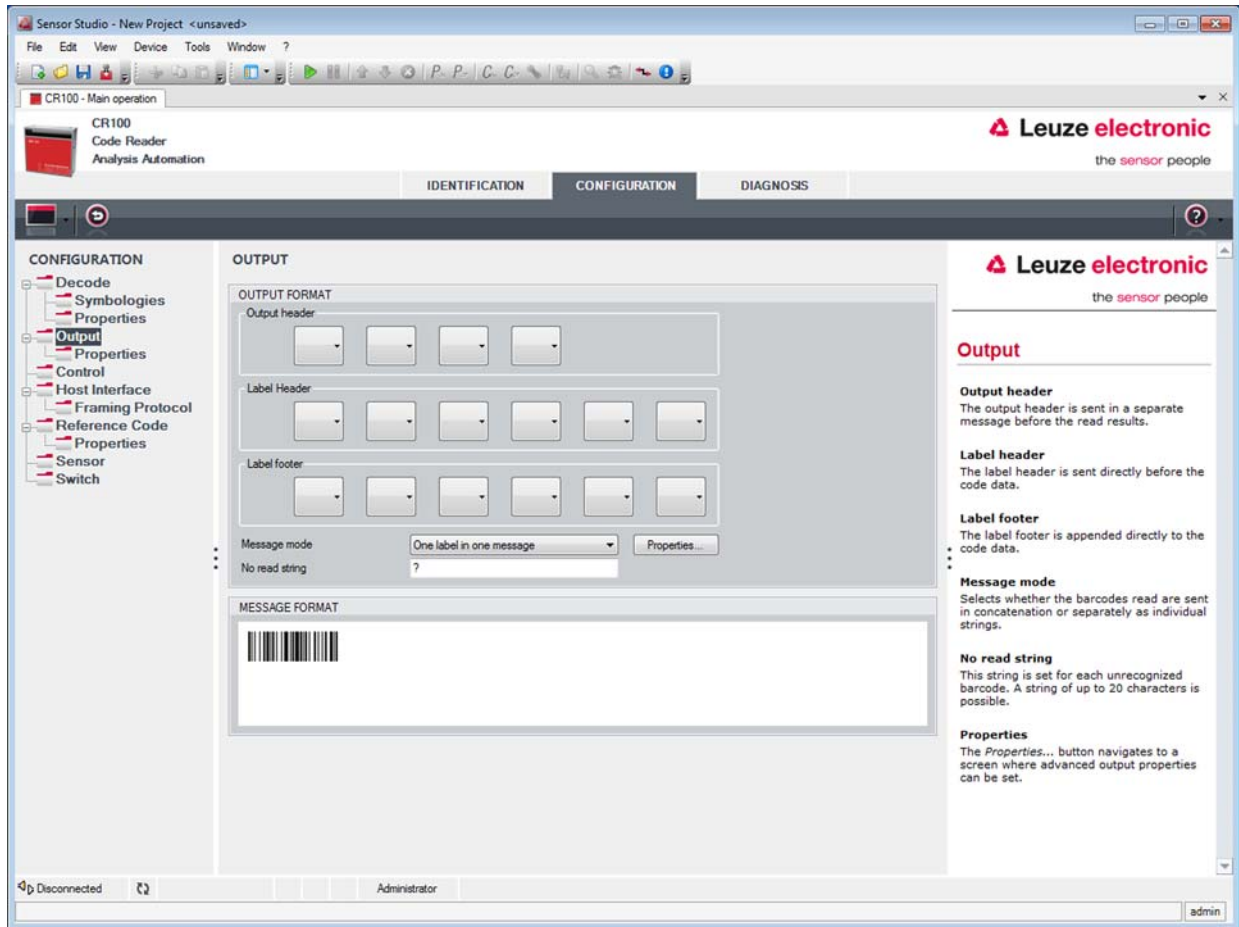

Figure 6.6: Output tab

- Output header** Select from the options listed below. The output header is sent in a separate message before the read result.
- Label header** The label header is set directly before the code data.
- Label footer** The label footer is appended directly to the code data.
- Message mode** Selects whether the bar codes read are sent in concatenation or separately as individual strings.



The structure of this message string is depicted symbolically in the preview window.

- No read string** This character is set for each unrecognized bar code. Multiple characters (=string) may be entered here. Up to 20 characters are possible.
- Output Properties** Set the desired formatting modes and formatting characters as necessary.

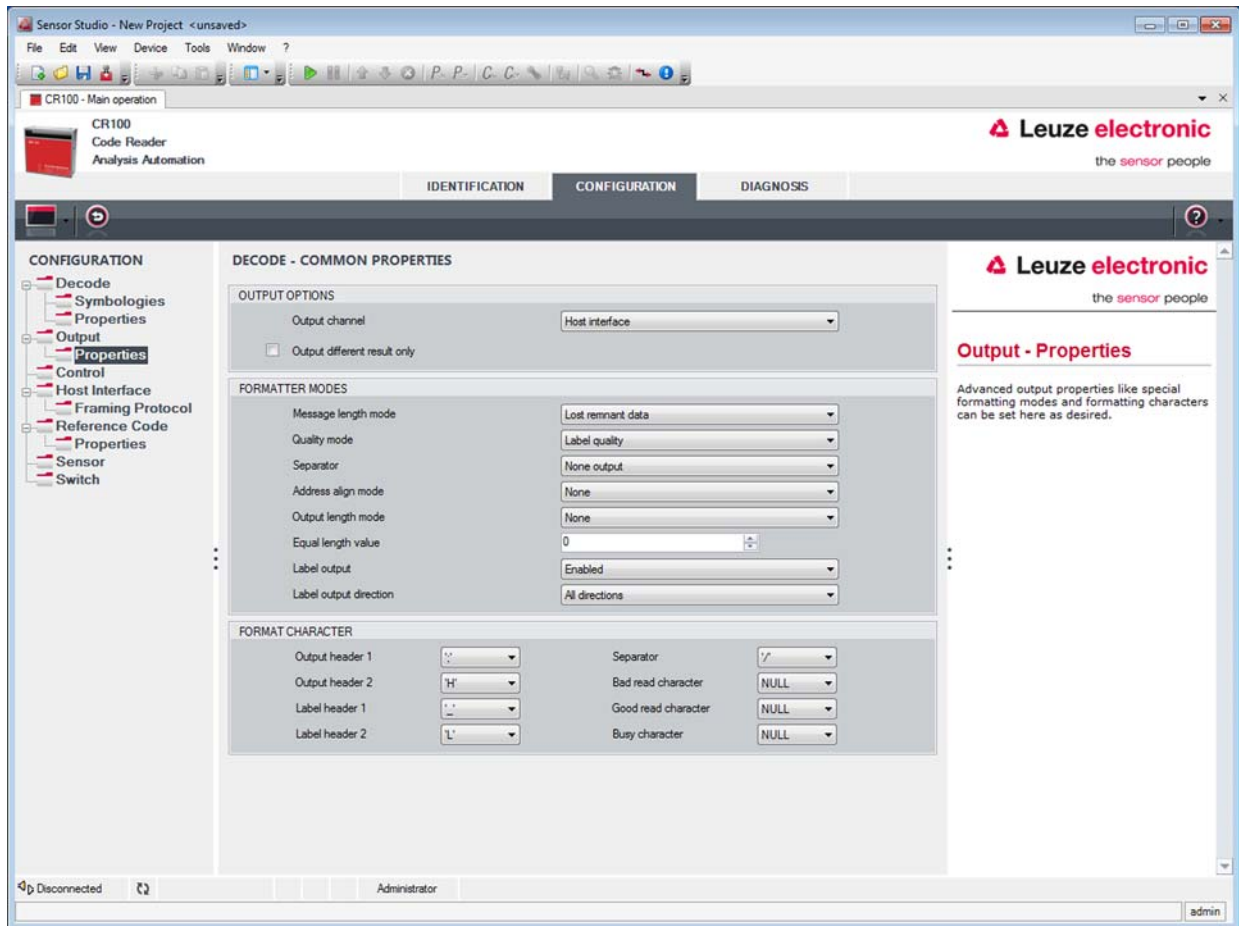

Figure 6.7: Standard settings for the Properties window – Output tab

6.5.3 Control tab

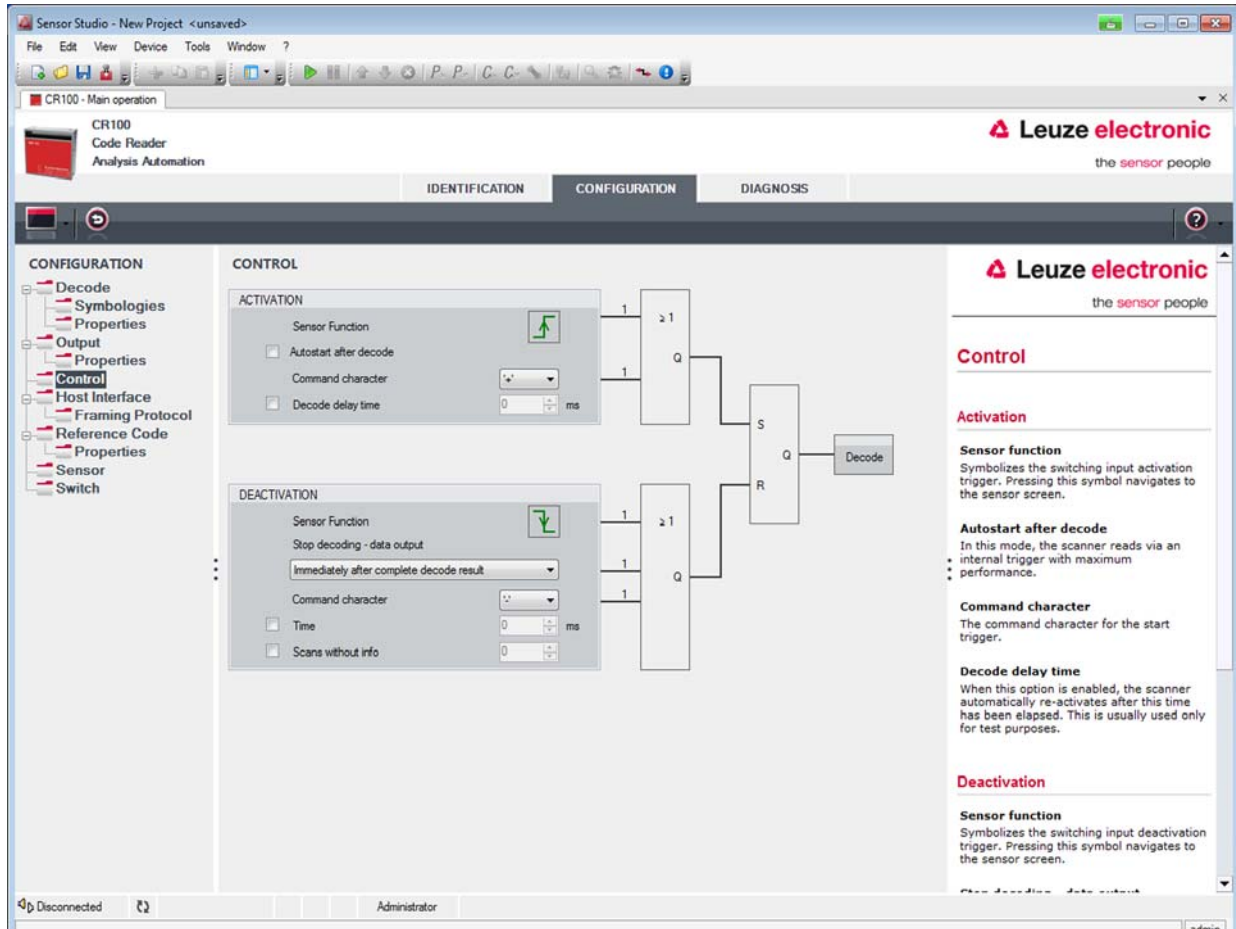

Figure 6.8: Control tab

Activation

Sensor 1 Function See menu “Sensor”

Autostart after decode In this mode, the scanner reads via an internal trigger signal with maximum performance.
Attention: Up to 100 codes per second may be transmitted.

Command character The standard online character for the trigger start is the ‘+’ character. This character can be changed only via the tree structure.

Decode delay time This point is usually used only for test purposes. After the time set here has passed, the scanner automatically reactivates itself following a reading gate end (e.g. in combination with “Autostart after decode”).

Deactivation

Sensor 1 Function See menu “Sensor”

Immediately after complete decode result If this item is activated, the read result is output immediately after the bar code is decoded.
If the item is deactivated, the read result is sent only after the trigger signal is returned (=end of reading gate).

- Command character** The standard online character for the trigger end is the ‘-’ character. This character can be changed only via the tree structure.

- Time** If the scanner is activated, the reading gate is automatically closed by the scanner after this preset time has elapsed (e.g. for test purposes).

- Scans without info** Following a successful read, the scanner waits for this number of scans (sequential scans with no read result) before it automatically deactivates itself.

6.5.4 Host interface tab

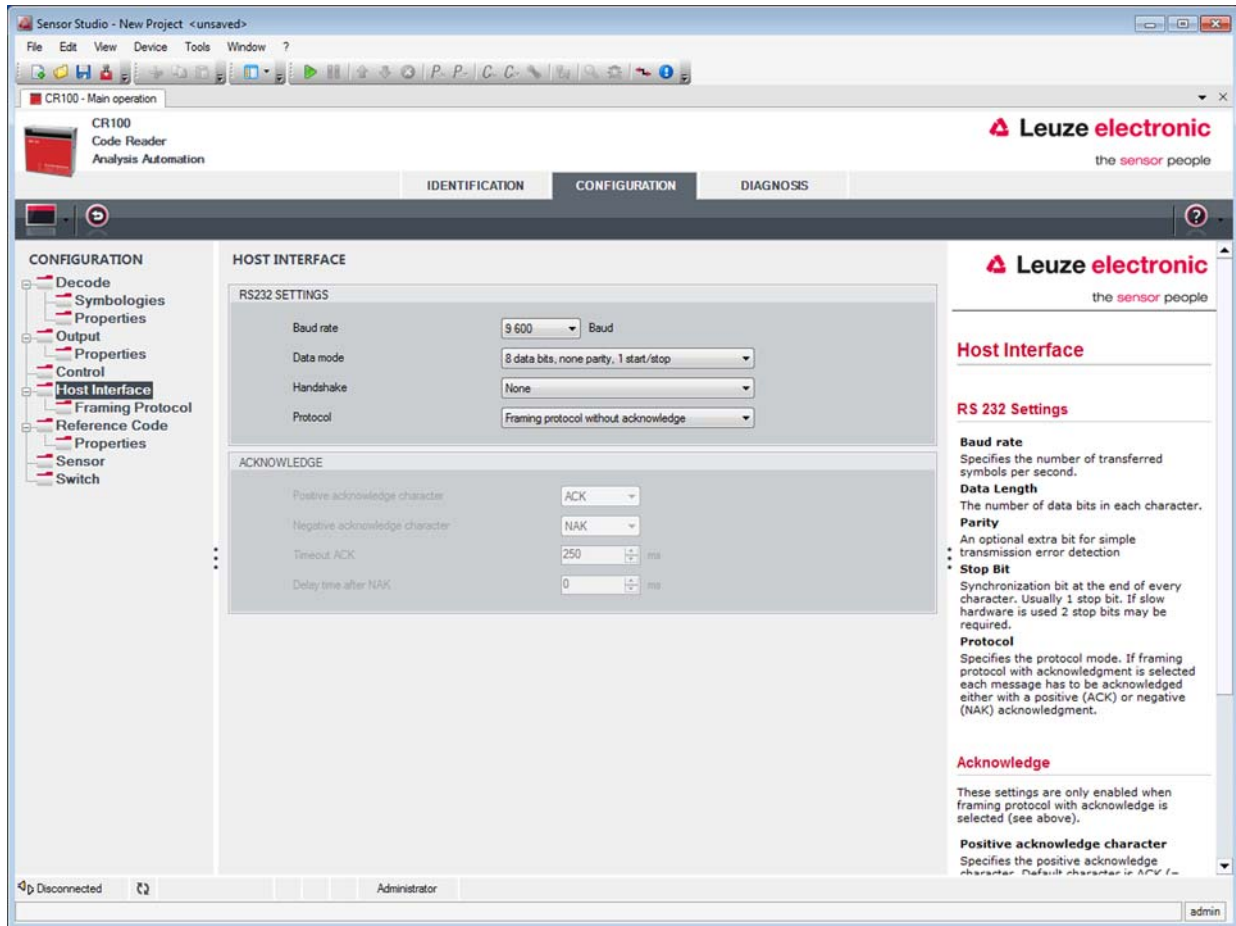

Figure 6.9: Host interface tab

Select the desired baud rate, the stop bits, the data bits, the parity and various transmission modes here. After switching on the CR 100, these parameters are not active until after the automatic “Power-On” test. The desired acknowledgment settings are also to be set in this selection window.

Properties window (Framing Protocol) – Host interface tab

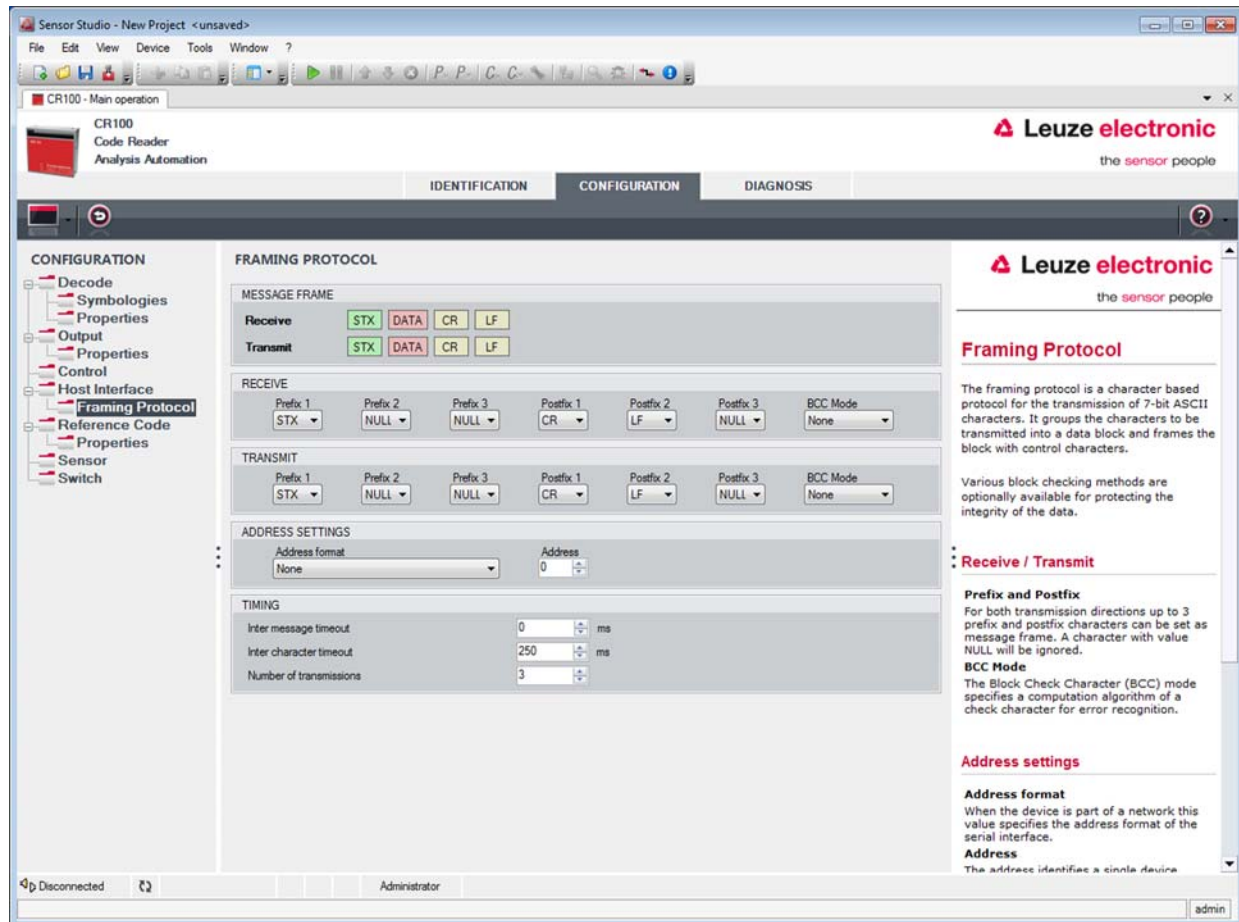

Figure 6.10: Standard settings for the Properties window (Framing Protocol) – Host interface tab

Here, you can change the address settings and the protocol for sending and receiving.

To be able to continue to communicate with a CR 100 following a parameter transfer, it may be necessary to make appropriate adjustments to the communication properties of the device in the *Sensor Studio* configuration software.

6.5.5 Reference code tab

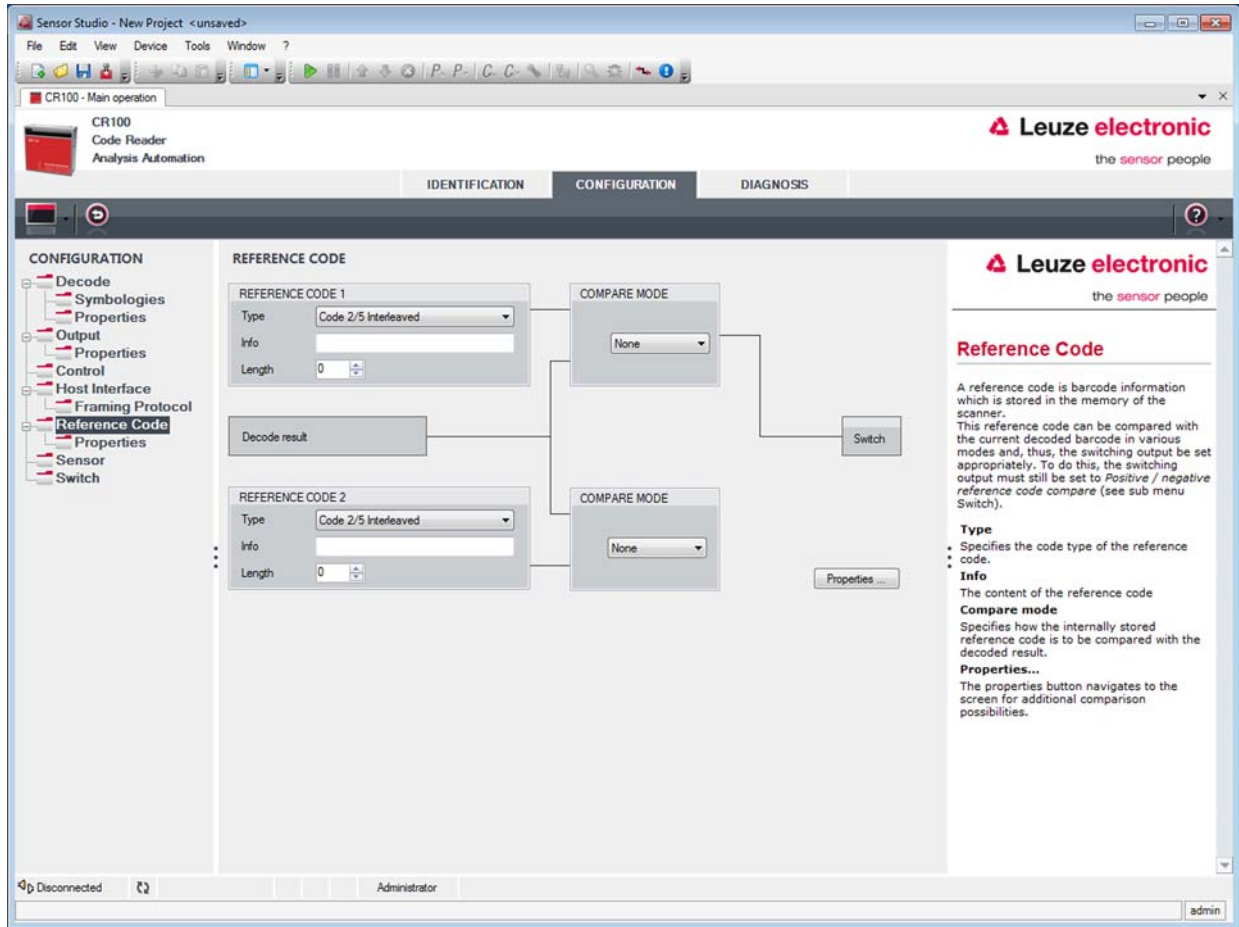

Figure 6.11: Reference code tab

A reference code is bar code information which is stored in the memory of the scanner.

This reference code can be compared with the current decoded bar code in various modes and, thus, the switching output be set appropriately. For this purpose, the switching output in the **SWITCH** menu is still set to **Reference Code Compare (Positive Reference Code Compare or Negative Reference Code Compare)**.

One possibility to save the reference code is to manually enter the value in this menu. For other possibilities offered by the reference code teach-in see chapter 8.

- Type** Select the code type.
- Info** Contents of the reference code.
- Compare mode** Select here how the internally stored reference code is to be compared with the decoded result.
For additional comparison possibilities, select the **Properties** menu

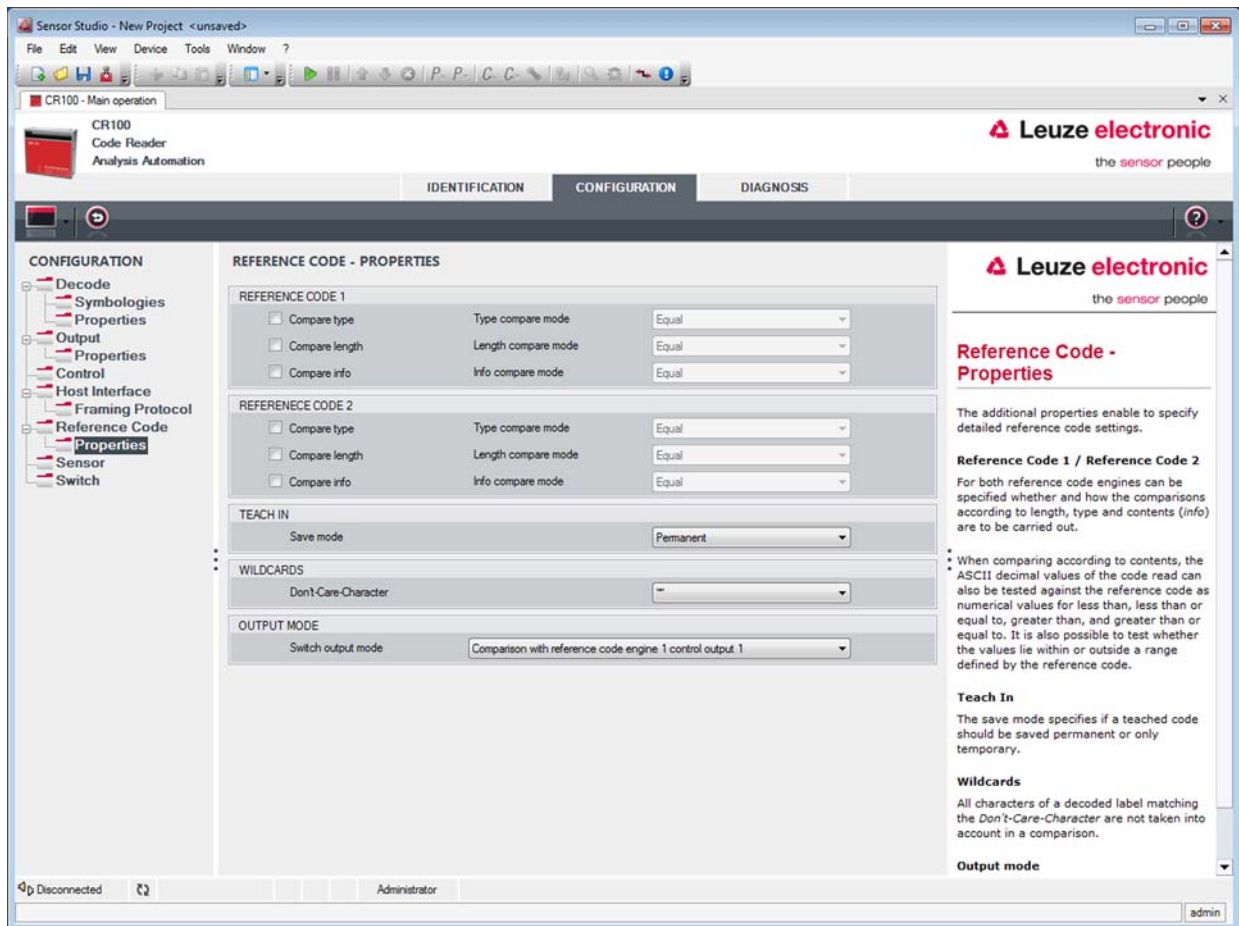

Figure 6.12: Standard settings for the Properties window – Reference code tab

6.5.6 Sensor tab

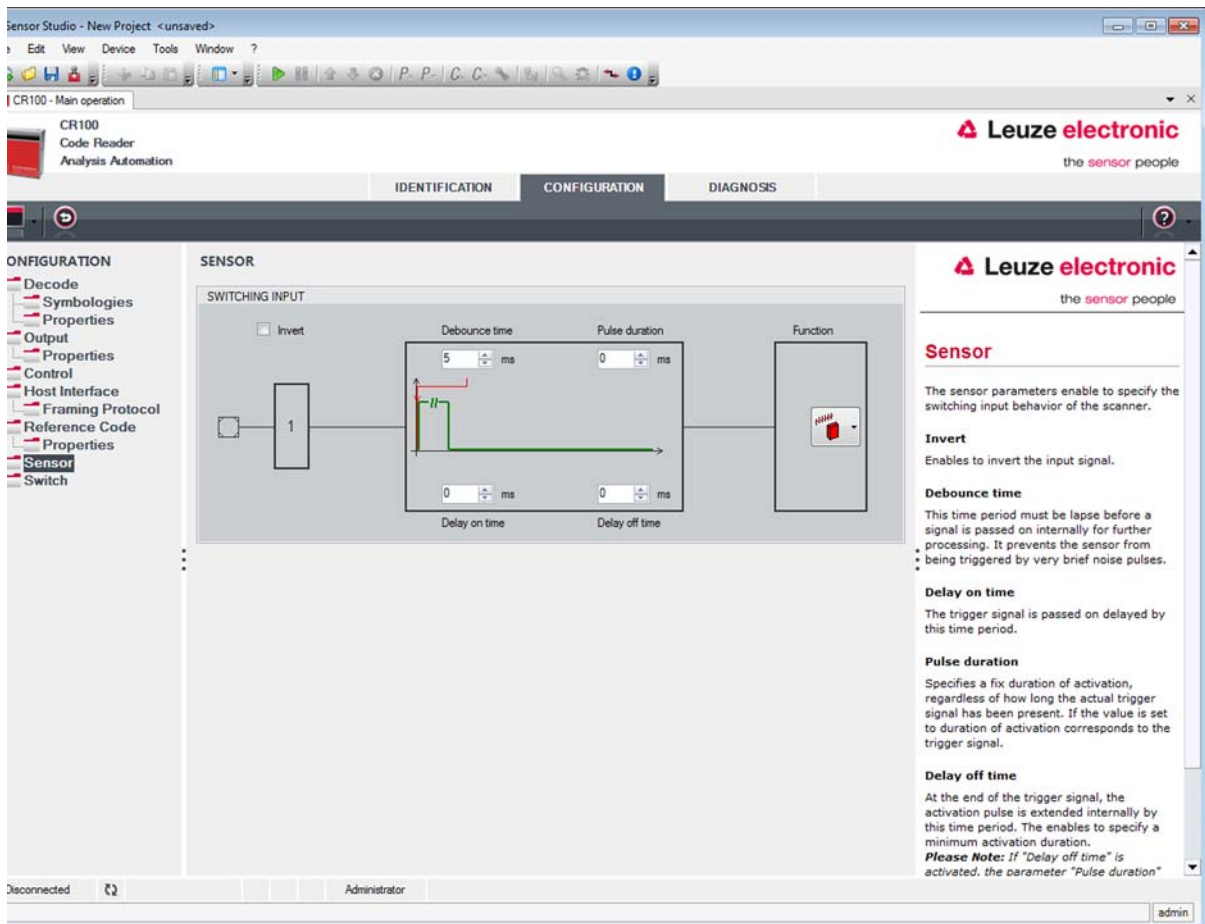

Figure 6.13: Sensor tab

- Invert** Here, the input level can be inverted.
- Debounce time** This time period must lapse until the trigger signal is regarded as valid.
- Delay on time** The trigger signal is passed on delayed by the specified time period.
- Pulse duration** If the value is higher than “0”: duration of the activation, regardless of how long the trigger signal has been present.
- Delay off time** After the end of the trigger signal, the pulse is extended internally by this time period.



If the switch-off delay is activated, the parameter “pulse duration” should be “0”.

- Function** Event that is started when the switching input is activated.

6.5.7 Switch tab

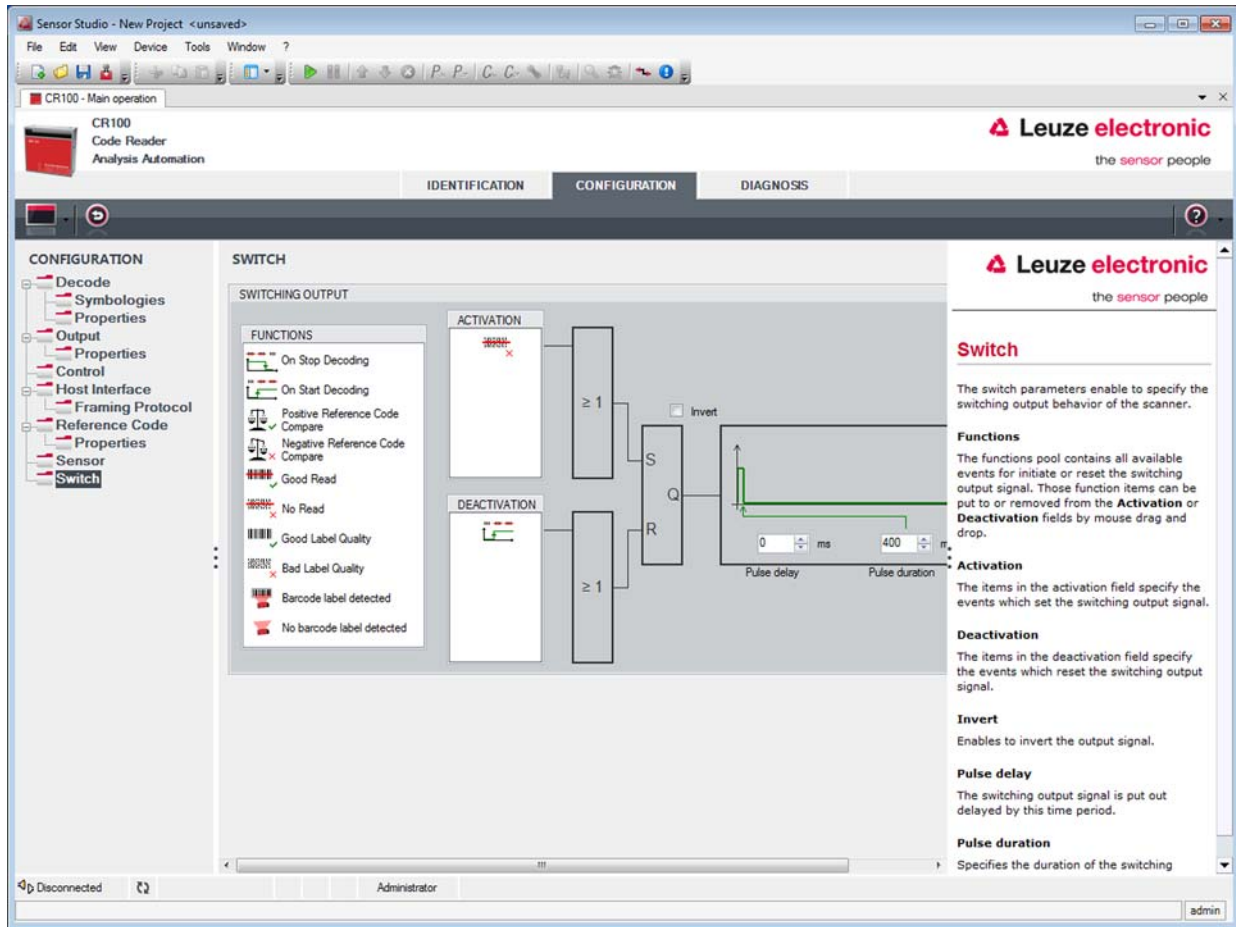

Figure 6.14: Switch tab

- Activation** Select the desired event which is to initiate the switching of the switching output here. Multiple events can also be simultaneously activated.
- Deactivation** Shown here is the event which results in the switching output being reset (if the set pulse duration has not yet expired). Multiple events can also be simultaneously activated.
- Invert** Level inverted.
- Pulse duration** Duration of the switching output impulse.
- Pulse delay** Length of time before the switching output is activated.

7 Starting up the device - Configuration

7.1 Measures to be performed prior to the initial commissioning

NOTICE

- ↳ Please observe the notices for device arrangement, see chapter 4.1.
- ↳ If possible, always trigger the scanner with the aid of commands or an external signal transmitter (photoelectric sensor).
Only then can you be certain whether a code has been read. If read, the code contents are transmitted; if not, the NoRead character is transmitted at the end of the reading gate).
- ↳ Before commissioning, familiarize yourself with the operation and configuration of the device(s).
- ↳ Before connecting the supply voltage, recheck all connections and ensure that they have been properly made.

7.2 Starting the device

7.2.1 "Power On" test

After connecting the operating voltage, the CR 100 performs an automatic "Power On" function test. During the start-up phase, the orange-colored LED on the rear of the scanner illuminates. When this switches off, customer-specific settings that may have been saved are active.

7.2.2 Interface

Proper function of the interface can be most easily tested in service operation using the serial interface with the *Sensor Studio* configuration software and a notebook computer.

7.2.3 "Online commands"

Using the "Online" commands, important device functions can be checked, e.g. reading activation.

7.2.4 Problems

For information on how to proceed in the event of problems during commissioning of the devices, see chapter 10.

If a problem occurs that cannot be rectified even after checking all electrical connections and settings on the devices and on the host, contact your responsible Leuze electronic subsidiary or Leuze electronic customer service, see chapter 11.

7.3 Setting the communication parameters

You have now commissioned the CR 100. Usually, you will have to configure it before you can use it. Using the configuration options offered in the *Sensor Studio* or by means of the device DTM of the CR 100, the bar code reader can be individually configured according to your application. For information on the various configuration options, see chapter 6 or refer to the online help.

To operate the CR 100, it is normally sufficient to set code type and code length in accordance with the bar codes that are to be read. Depending on the application, you can configure the switching input and switching output according to your requirements.

The setting of code type and code length is usually accomplished by using the *Sensor Studio* configuration software, see chapter 6.

The various parameter sets are explained in brief to understand what is happening during parameter setting, see chapter 7.3.1.

The parameters are then set using the buttons under **CONFIGURATION**. To transfer the settings to the CR 100, its RS 232 settings must be set to the "Service" operating mode, see chapter 7.3.2.

7.3.1 Parameter sets

factory default parameter set

This parameter set contains the default settings made ex works for all CR 100 parameters. It is permanently stored in the FLASH-ROM of the CR 100.

The parameter set with the factory settings is loaded into the main memory of the CR 100

- the first time the device is commissioned after delivery;
- following the command "Factory Default" in the configuration program (online command 'PC20');
- if the checksums of the current parameter set are invalid.

Current parameter set

In this parameter set, the current settings for all device parameters are stored. When the CR 100 is in operation, the parameter set is stored in the EEPROM of the CR 100.

The current set can be stored:

- by copying a valid parameter set from the host computer to the CR 100;
- by an off-line setup using the *Sensor Studio* configuration software and then subsequently copying to the CR 100.

The current parameter set is loaded into the main memory of the CR 100:

- by a parameter command, see chapter "Copying parameter set".

7.3.2 "Service" operating mode

You can connect a PC or a terminal to the CR 100 via the serial interface and configure the CR 100 through this connection; see chapter 5.4 "PC or terminal connection".

Setting the required parameters is most easily carried out in the "Service" operating mode.

The operating mode "Service" provides the following defined operating parameters on the RS 232 interface, no matter how the CR 100 is configured for standard operation:

- transmission rate: 9600 baud
- no parity
- 8 data bits
- 1 stop bit
- prefix: STX
- postfix: CR, LF

Activating the service interface

The service interface can be activated by holding a defined bar code label ("Service", see figure 7.1) in front of the reading window during power-up (initialization phase).



Figure 7.1: Bar code label "Service"

While the red light is switched on for approx. 1 s after power-up, the "Service" label is to be held up in front of the bar code reader at a suitable read distance. When the device is in "Service" mode, the status LED flashes orange.

8 Online commands

8.1 Overview of commands and parameters

Online commands can be used to send commands directly to the device for control and configuration. For this, the CR 100 has to be connected to a computer (host) via the serial interface, see chapter 7.3.2. Information about the transmission protocol: see chapter 6.5.4.

Using the “online” commands you can:

- control/decode the reading gate.
- read/write/copy parameters.
- carry out an automatic configuration.
- teach/set a reference code.
- call up error messages.
- call up statistical device information.
- carry out a software reset in order to reinitialize the device.

Syntax

“Online” commands consist of one or two ASCII characters followed by command parameters.

No separation characters may be entered between the command and the command parameter(s). Both small and capitalized letters can be used.

Example:

Command 'CA':	autoConfig function
Parameter '+':	Activation
Transmitted is:	'CA+'

Notation

Commands, parameters and returned data are enclosed between single quotation marks ' ' in the text of this manual.

Most online commands are acknowledged by the CR 100 and any requested data returned. For commands that are not acknowledged, command execution can be observed or monitored directly on the device.

8.2 General online commands

Software version number

Command	'V'
Description	Requests device version information
Parameter	None
Acknowledgment	Example: 'CR 100 V 00.16 17.11.2014' The device type appears in the first line followed by the device's version number and date. The data which is actually displayed may vary from the values given here.



You can use this command to check whether the communication between PC and scanner is functional. If you do not receive an acknowledgment, please check the interface connections or the protocol.

Software reset

Command	'H'
Description	Carries out a software reset. The device is restarted and reinitialized, leaving it in the same state as when the supply voltage is switched on.
Parameter	No
Acknowledgment	'S' (start signal)

autoConfig

Command	'CA'
Description	Activates or deactivates the autoConfig function. Certain label reading parameters are programmed automatically in the setup by the label which is read by the device while the 'autoConfig' function is active.
Parameter	'+' Activates 'autoConfig'
	'/' Rejects the last code read
	'-' Deactivates 'autoConfig' and stores the decoded data in the current parameter set
Acknowledgment	'CSx'
	x Status
	'0' Valid 'CA' command
	'1' Invalid command
	'2' 'autoConfig' could not be activated
	'3' 'autoConfig' could not be deactivated
	'4' Result could not be deleted
Description	'xx yy zzzzzz'
	xx Code type of the read code
	'01' 2/5 Interleaved
	'02' Code 39
	'06' UPC (A, E)
	'07' EAN
	'08' Code 128, EAN 128
	'09' Pharmacode
	'10' EAN/UPC
	'11' Codabar
	'12' Code 93
	yy Number of elements of the read code
	zzzz Contents of the decoded label. The appears if the label was not correctly read.
	zz

Manual definition of the reference code

Command	RS	
Description	This command can be used to define a new reference code in the CR 100 by means of direct input via the serial interface. The data is saved in the parameter set according to your input under reference code 1 or 2 and stored in the working buffer for direct further processing.	
Parameter	'RSyvxxzzzzzzzz'	
	y v x and z are placeholders (variables) for the actual input.	
	y Def. reference code no.	
	'1' (code 1)	
	'2' (code 2)	
	v Storage location for reference code:	
	'0' RAM+EEPROM	
	'3' RAM only	
Parameter	xx Def. code type (see command 'CA')	
	z Def. code information (1 ... 30 characters)	
	Acknowledgment	'RSx'
	x Status	
Acknowledgment	'0' Valid Rx command	
	'1' Invalid command	
	'2' Insufficient memory for reference code	
	'3' Reference code has not been saved	
Acknowledgment	'4' Reference code invalid	
	Example	Input = 'RS130678654331' (Code 1 (1), RAM only (3), UPC (06), code information)

Teach-In

Command	'RT'
Description	This command enables a reference code to be defined quickly by reading an example label.
Parameter	'RTy'
	y Function
	'1' Defines reference code 1
	'2' Defines reference code 2
	'+' Activates the definition of reference code 1 or 2
'-' Ends the teach event	

Command	'RT'
Acknowledgment	The CR 100 first responds with the command ' RS ' and corresponding status (see command 'RS'). After a bar code has been read, it sends the result in the following format: 'RCyvxzzzzz' y, v, x and z are placeholders (variables) for the actual input.
	y Def. reference code no.
	'1' (code 1)
	'2' (code 2)
	v Storage location for reference code:
	'0' RAM+EEPROM
	'3' RAM only
	xx Def. code type (see command 'CA')
	z Def. code information (1 ... 30 characters)

 With this function, only code types are recognized that are identified using the autoConfig function or which were set in the set-up.

⚠ After each reading via an 'RTy' command, explicitly switch off the function again since failure to do so will interfere with other commands as well as prevent execution of a new 'RTy' command.

Reading a reference code

Command	'RR'
Description	The command reads out the reference code defined in the CR 100. If no parameters are specified, all defined codes are output.
Parameter	<reference code number>
	'1' Reference code 1
	'2' Reference code 2
Acknowledgment	If no reference codes are defined, the CR 100 responds with the command ' RS ' and corresponding status (see command 'RS'). For valid codes, the output corresponds to the following format: 'RCyvxzzzzz' y, v, x and z are placeholders (variables) for the actual input.
	y Def. reference code no.
	'1' (code 1)
	'2' (code 2)
	v Storage location for reference code:
	'0' RAM+EEPROM
	'3' RAM only
	xx Def. code type (see command 'CA')
	z Def. code information (1 ... 30 characters)

Alignment mode

Command	'JP'
Description	<p>This command is used for simplified mounting and alignment of the CR 100 in static installation situations. After activating the function with 'JP+', the scanner continuously supplies status information to the serial interfaces. With this online command, the scanner is set to terminate the decoding after 100 successfully decoded labels and output the status information. Subsequently, the read process is reactivated automatically. As status, the output returns the following values:</p> <ul style="list-style-type: none"> scans which contain the valid label information on the basis of 100 scans, the decoding result. <p>These values can be used to determine the decoding quality:</p> <ul style="list-style-type: none"> If the reading quality is high, the red light beam flashes in brief, regular intervals. The worse the decoder decodes, the longer the pauses become during which the red light is switched off.
Parameter	'+' Starts the adjustment mode.
	'-' Ends the adjustment mode.
Acknowledgment	'xxxxx_yyyyy'
	xxxxx "Scans since reading gate release" (scans_with info): Number of scans that contain valid label information. The maximum value is 100.
	yyyyy Bar code information.

8.3 Online commands for system control

Activating sensor input

Command	'+'
Description	The command activates decoding.
Parameter	None
Acknowledgment	None

Deactivating sensor input

Command	'-'
Description	The command deactivates decoding.
Parameter	None
Acknowledgment	None

Activate switching output

Command	'OA'
Description	The command activates the switching output.
Parameter	'OAx': Activate switching output
	x Switching output no.
	'1' (output 1)
Acknowledgment	none

Deactivate switching output

Command	'OD'
Description	The command deactivates the switching output.
Parameter	'ODx': Deactivate switching output
	x Switching output no.
	'1' (output 1)
Acknowledgment	none

8.4 Online commands for the parameter set operations

Definitions

- **<BCC type>** Type of checksum calculation.
 '0': No checksum
 '3': XOR checksum (mode 3)
- **<PS type>** Parameter set type
 '0': Current parameter set (data stored non-volatilely in the EEPROM)
 '1': Reserved
 '2': Standard parameter set (not changeable)
 '3': Operating values (data in the RAM, will be lost after reset)
- **<Status>** Mode of parameter processing
 '0': Does not perform a reset following the write operation; no other parameters follow.
 '1': Does not perform a reset following the write operation; other parameters follow.
 '2': Subsequently performs a reset, no other parameters follow.
- **<Start address>** Relative address of the parameter within the parameter set
- **<Para0L> <Para0H>... <Para122L> <Para122H>**:
 Parameter-set data of the message. The sequence of the data is arranged identically to the CR 100, i.e. when a word is transmitted, first the low byte is sent then the high byte. The parameter-set data is converted for transmission from HEX format to a 2-byte-ASCII format. During the conversion, two ASCII characters - representing the lower and higher nibbles - are created for each HEX value.
 Example:

Decimal	Hex	Transmission
4660	0x1234	'1' '2' '3' '4' = 31h 32h 33h 34h

- Para0H = 31h, Para0L = 32h, Para1H = 33h, Para1L = 34h
 Taking into consideration the maximum message length and the remaining command parameters, a maximum of 123 bytes of parameter data (246 bytes of message data) can be transmitted in a single operation.
 Valid values: '0' ... '9', 'A' ... 'F'
- **<Acknowledgment>**:
 Acknowledgment of the transmitted message
 '0' Valid transmission
 '1' Invalid message
 '2' Invalid message length
 '3' Invalid block check type
 '4' Invalid block check checksum
 '5' Invalid data length
 '6' Invalid message data
 '7' Invalid start address
 '8' Invalid parameter set
 '9' Invalid parameter type

Copying parameter set

Command	'PC'
Description	The command copies complete parameter sets.
Parameter	'03' Copy parameters from the EEPROM into the RAM and initialize all associated functions
	'20' Copy standard parameters from the FLASH into the EEPROM and RAM and initialize all relevant functions
	'30' Copy parameters from the RAM into the EEPROM
Acknowledgment	'PSx'
	x Status
	'0' Valid transmission
	'1' Invalid message
	'2' Invalid message length
	'3' Invalid block check type
	'4' Invalid block check checksum
	'5' Invalid data length
	'6' Invalid message data
	'7' Invalid start address
	'8' Invalid parameter set
	'9' Invalid parameter type
Example	'PC20' loads the default parameters

Request parameter set from the CR 100

Command	'PR'
Description	The command requests parameter data from the CR 100. The <PS type> parameter indicates from which parameter set the data are to be transferred.
Parameter	<BCC type><PS type><Start address><Data length>

Command	'PR'
Acknowledgment	'PSx'
	x Status
	'0' Valid transmission
	'1' Invalid message
	'2' Invalid message length
	'3' Invalid block check type
	'4' Invalid block check checksum
	'5' Invalid data length
	'6' Invalid message data
	'7' Invalid start address
	'8' Invalid parameter set
	'9' Invalid parameter type
Example	'PR00102004' Beginning with address 102, four (004) bytes are read out and transmitted.

Acknowledge parameter message

Command	'PS'
Description	The command acknowledges the received message and delivers an acknowledgment status which indicates whether the message was valid or invalid.
Parameter	'PSx'
	x Status
	'0' Valid transmission
	'1' Invalid message
	'2' Invalid message length
	'3' Invalid block check type
	'4' Invalid block check checksum
	'5' Invalid data length
	'6' Invalid message data
	'7' Invalid start address
	'8' Invalid parameter set
	'9' Invalid parameter type

Transfer parameters

Command	'PT'
Description	The command transmits parameter data beginning with the set address and stores it there in an intermediate buffer. If the status indicates that further messages follow, these are also stored in the intermediate buffer before they are then stored under the corresponding parameter set type in the EEPROM. The transmission can optionally occur with a block check test of the message data.
Parameter	<BCC type> <PS type> <Status> <Start address> <Para0L> <Para0H> [... <Para122L>][<BCC>]
Acknowledgment	'PSx'
	x Status
	'0' Valid transmission
	'1' Invalid message
	'2' Invalid message length
	'3' Invalid block check type
	'4' Invalid block check checksum
	'5' Invalid data length
	'6' Invalid message data
	'7' Invalid start address
	'8' Invalid parameter set
	'9' Invalid parameter type
Example	'PT03203305' Address 33 (Equal Scans) is set to 5. Save in RAM with reset (immediate acceptance of the change and temporary storage)

9 Care, maintenance and disposal

Usually, the CR 100 bar code reader does not require any maintenance by the operator.

9.1 Cleaning

Clean the glass window of the CR 100 with a soft cloth before mounting.

NOTICE
Do not use aggressive cleaning agents!
↪ Do not use aggressive cleaning agents such as thinner or acetone to clean the device.

9.2 Servicing

Repairs to the device must only be carried out by the manufacturer.

↪ For repairs, contact your responsible Leuze electronic subsidiary or Leuze electronic customer service (see chapter 11).

9.3 Disposing

↪ For disposal observe the applicable national regulations regarding electronic components.

10 Diagnostics and troubleshooting

Error, warning and status messages of the CR 100 are transmitted via the RS 232 interface.

Troubleshooting

Isolated warnings can be ignored, since the CR 100 will continue to function properly.

Following a serious error, you should reinitialize the CR 100. It will then usually again function properly. If a hardware problem is present, the CR 100 will not reinitialize.

Frequently occurring warnings and errors can be most easily rectified via the *Sensor Studio* configuration software / CR 100 DTM .

If you cannot rectify faults and errors with the software, please contact your responsible Leuze electronic subsidiary or Leuze electronic customer service (see chapter 11).

Faults	Possible error cause	Measures
No communication possible	Incorrect wiring.	Check wiring.
	Wrong interface selected.	Select correct interface in the <i>Sensor Studio</i> tool.
	Different protocol settings.	Check protocol settings in the CR 100 and <i>Sensor Studio</i> tool or switch the CR 100 to service mode.
No code reading possible	Code reading not possible (quality).	Improve code quality! Entire code in laser line?
	Code is not enabled.	Check entries in the code table (type and length).
	Excessive reflections.	Increase angle of the laser beam to > 10° with respect to vertical.

11 Service and support

24-hour on-call service at:
+49 (0) 7021 573-0

Service hotline:
+49 (0) 7021 573-123
Monday to Friday 8.00 a.m. to 5.00 p.m. (UTC+1)

E-mail:
service.identify@leuze.de

Return address for repairs:
Service center
Leuze electronic GmbH + Co. KG
In der Braike 1
D-73277 Owen / Germany

11.1 What to do should servicing be required?

NOTICE
Please use this chapter as a master copy should servicing be required!
↪ Enter the contact information and fax the form together with your service order to the fax number given below.

Customer data (please complete)

Device type:	
Serial number:	
Firmware:	
Display messages:	
LED states:	
Error description:	
Company:	
Contact person/department:	
Phone (direct):	
Fax:	
Street/No:	
ZIP code/City:	
Country:	

Leuze Service fax number:
+49 (0) 7021 573-199

12 Technical data

12.1 General specifications

Table 12.1: Optics

Light source	LED 660 nm (visible red light)
Wavelength	660 nm
Beam exit	at front, alternatively 13° at side
Scanning rate	M-optics: 700 scans/s
Optics models / resolution	M-optics: m = 0.150 ... 0.500 mm / 6 ... 20 mil
Reading distance	see chapter 12.2 "Reading fields"
Reading field opening	see chapter 12.2 "Reading fields"
Code types	2/5 Interleaved, Code 39, Code 128, EAN 128, EAN/UPC, EAN Addendum, Codabar, Pharma Code, Code 93
Software features	selectable output format, multiple read, real time decoding, control of the switching input/output

Table 12.2: Electrical equipment

Interface type	RS 232, freely configurable
Baud rate	4800 ... 57600 baud
Data formats	data bits: 7, 8 parity: none, even, odd stop bit: 1, 2
Protocols	framing protocol with/without handshake software handshake X ON / X OFF
Service interface	RS 232 with fixed data format, 9600 Bd, 8 data bits, no parity, 1 stop bit <STX> <data> <CR><LF>
Ports	1 switching input 5 V DC 1 switching output 5 ... 30V, 20 mA
LEDs	1 device and read status
Supply voltage	4.9 ... 5.4 V DC, Safety Class III - PELV (Protective Extra Low Voltage) Notice: For UL applications: only for use in "Class 2" circuits according to NEC
Current consumption	max. 250 mA (2 W power supply unit recommended)

Table 12.3: Mechanics

Degree of protection	IP 40
Connection type	cable 2 m long, 6 x 0.081 mm ² (AWG 28)
Weight	70 g
Dimensions (HxWxD)	front beam exit: 47 x 55 x 20 mm lateral beam exit: 52 x 55 x 20 mm
Housing	metal

Table 12.4: Environmental data

Ambient temp. (operation/storage)	0 °C ... +45 °C/-25 °C ... +60 °C
Air humidity	max. 90 % rel. humidity, non-condensing
Electromagnetic compatibility	EN 55022, EN 55024 IEC 61000-4-2, -3, -4 and -6,
Conformity	CE, FCC Class B
Certifications	UL recognized under way

12.2 Reading fields



Please note that the actual reading fields are also influenced by factors such as labeling material, printing quality, scanning angle, printing contrast etc., and may thus deviate from the reading fields specified here. The origin of the read distance always refers to the front edge of the housing of the beam exit.

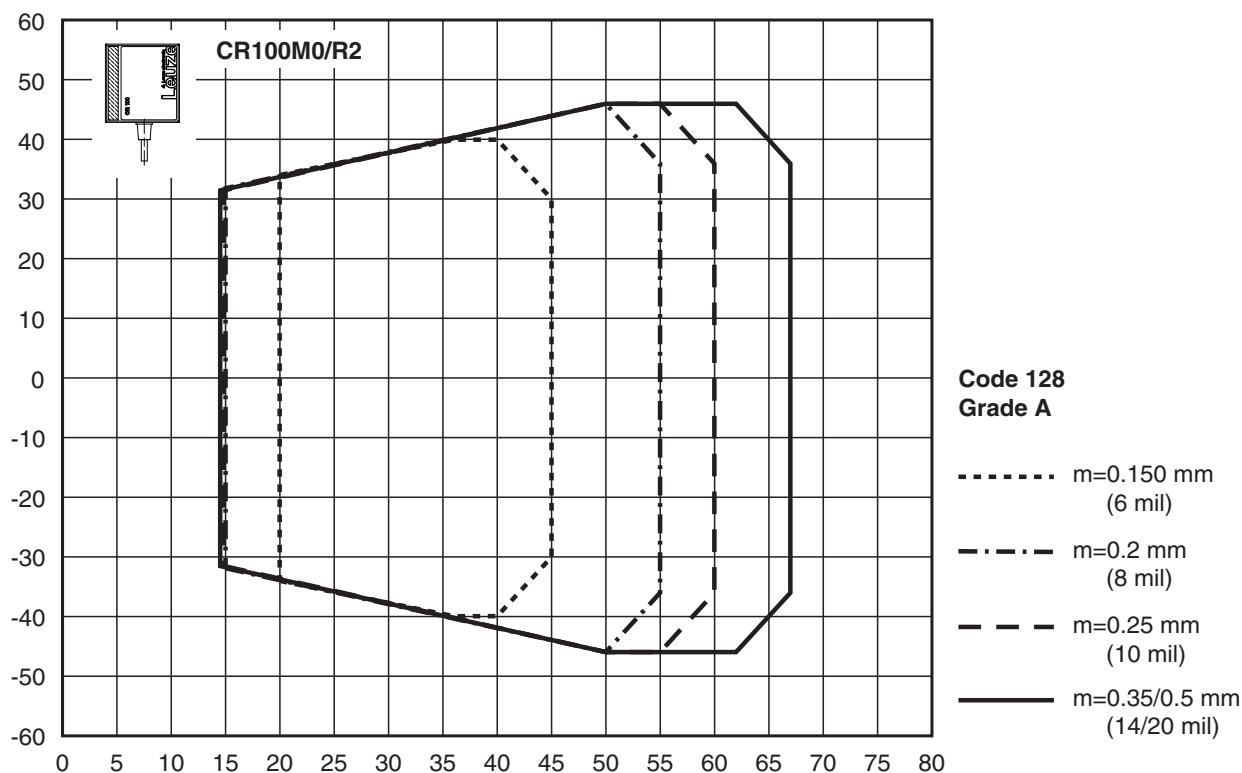

Figure 12.1: Reading field of CR 100M0/R2

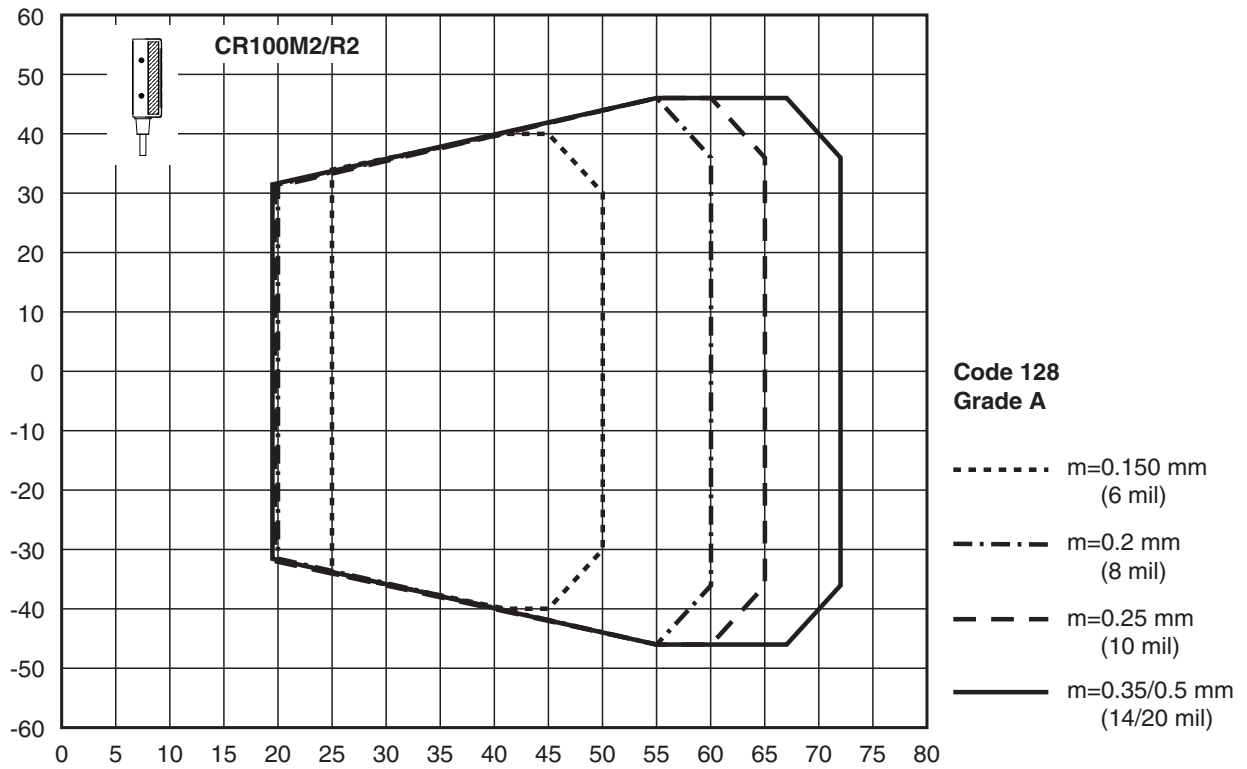

Figure 12.2: Reading field of CR 100M2/R2

12.3 Dimensioned drawings

CR 100M0/R2 with lateral beam exit

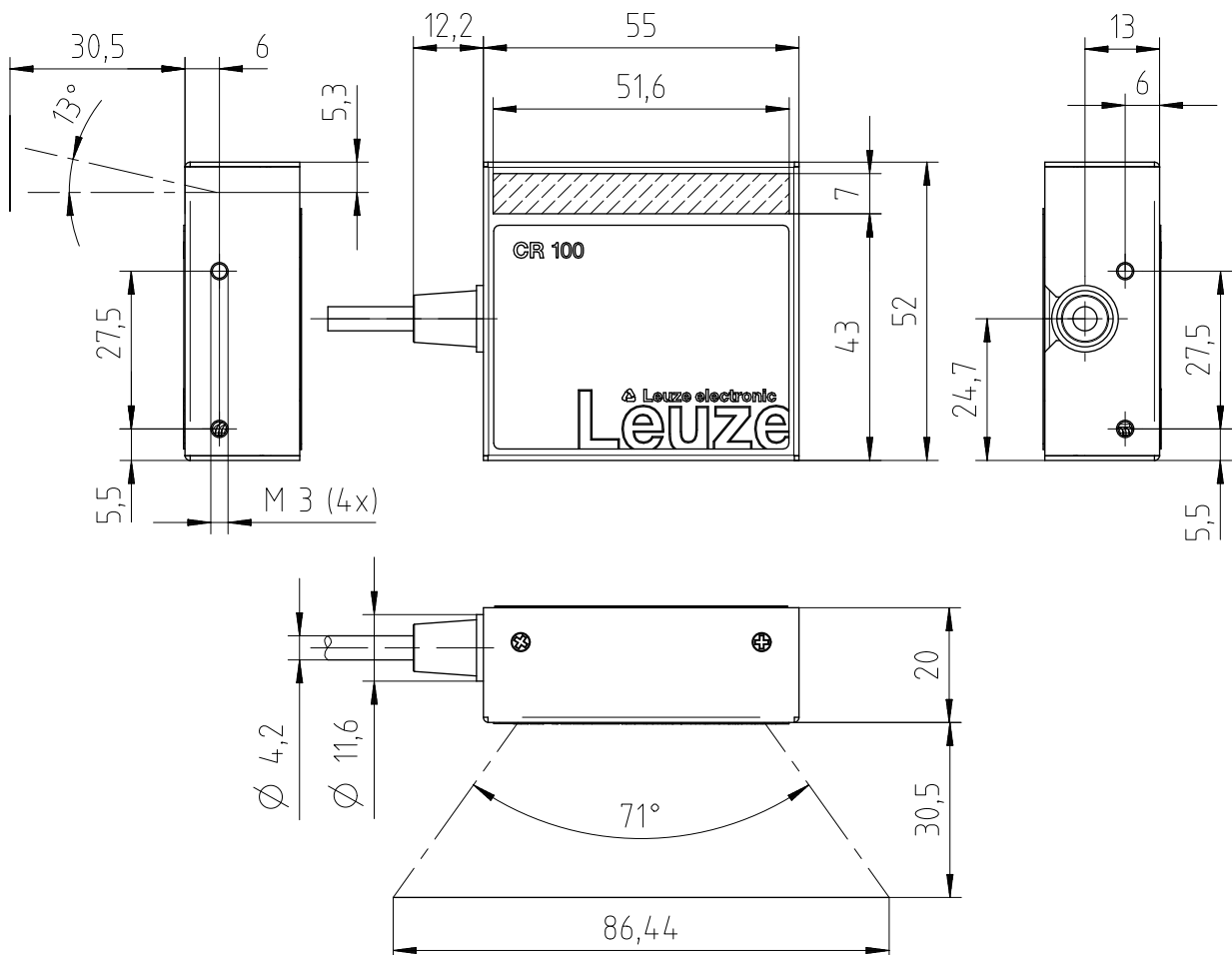

Figure 12.3: Dimensioned drawing of CR 100M0/R2 with lateral beam exit

CR 100M2/R2 with front beam exit

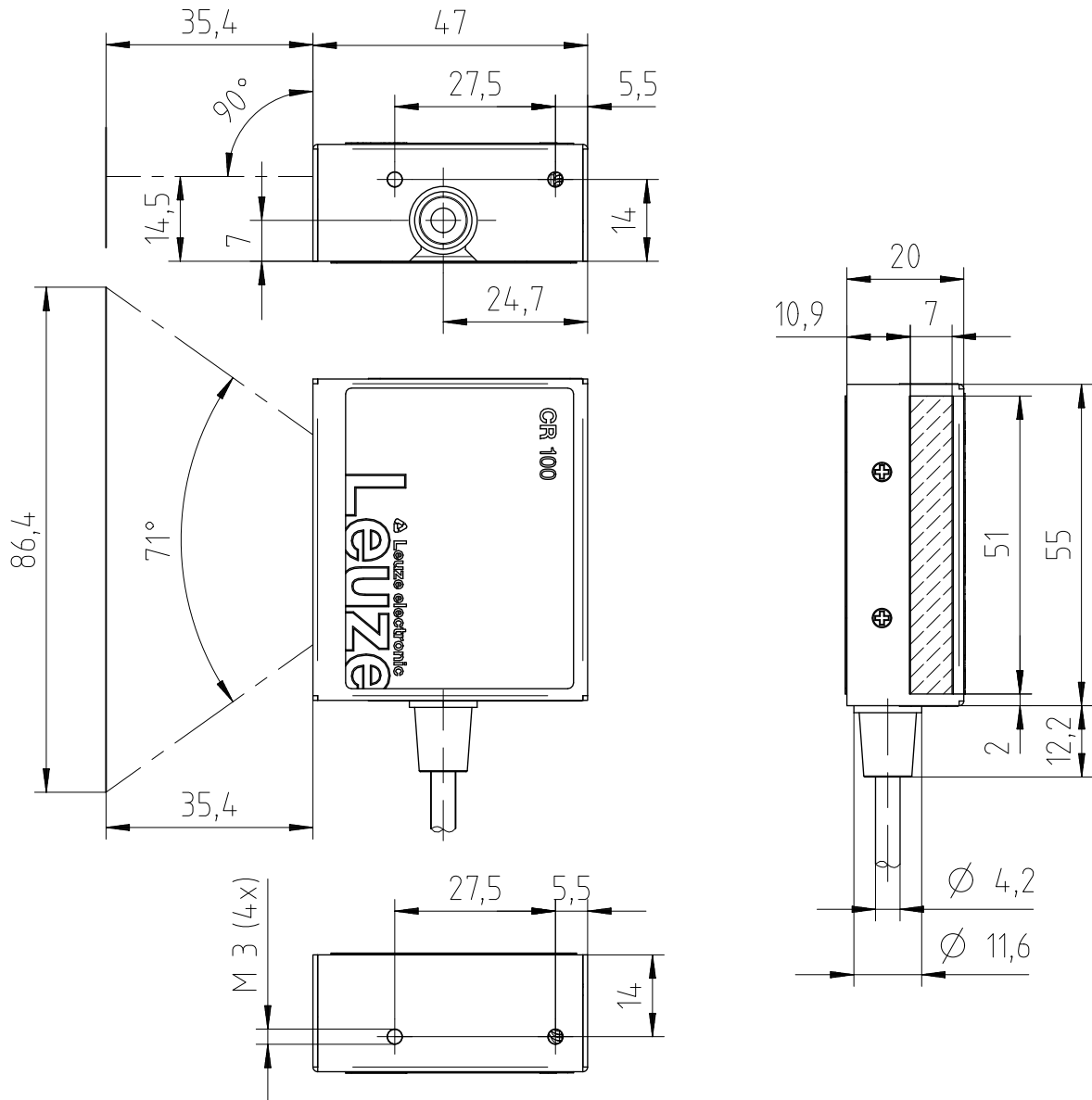

Figure 12.4: Dimensioned drawing of CR 100M2/R2 with front beam exit

13 Ordering information and accessories

13.1 Type overview

Table 13.1: Part numbers

Part no.	Part designation	Description
50127451	CR100M0/R2	Line scanner, lateral beam exit, Medium Density
50127450	CR100M2/R2	Line scanner, front beam exit, Medium Density

13.2 Accessories

Table 13.2: Accessories

Part no.	Part designation	Description
50128204	MA-CR	Adapter circuit board with spring terminals and 9-pin SUB-D socket
50113396	KB DSub-9P-3000	RS 232 interconnection cable, cable length 3 m
<i>Sensor Studio</i> configuration software Download at www.leuze.com see chapter 6.2.1 "Downloading configuration software"		<i>Sensor Studio</i> designed according to the FDT/DTM concept. Contains: communication DTM and device DTM

14 EC Declaration of Conformity

The bar code readers of the CR 100 series have been developed and manufactured in accordance with the applicable European standards and directives.



15 Appendix

15.1 Bar code samples



1122334455

Module 0.3

Figure 15.1: Code type 01: Interleaved 2 of 5



135AC

Module 0.3

Figure 15.2: Code type 02: Code 39



a121314a

Module 0.3

Figure 15.3: Code type 11: Codabar



abcde

Module 0.3

Figure 15.4: Code 128



abcde

Module 0.3

Figure 15.5: Code type 08: EAN 128



1 23456 78901 2

SC 2

Figure 15.6: Code type 06: UPC-A



3456 7890

SC 3

Figure 15.7: Code type 07: EAN 8



Figure 15.8: Code type 10: EAN 13 Add-on