

## Technical data sheet Safety light curtain receiver

Part no.: 68017313

MLC510R30-1350H/A



### Contents

- Technical data
- Dimensioned drawings
- Electrical connection
- Operation and display
- Suitable transmitters
- Part number code
- Notes
- Accessories



## Technical data

### Basic data

Series	MLC 500
Device type	Receiver
Cascading	Host
Application	Hand protection

### Characteristic parameters

Type	4, IEC/EN 61496
SIL	3, IEC 61508
SILCL	3, IEC/EN 62061
Performance Level (PL)	e, EN ISO 13849-1
PFH <sub>D</sub>	7.73E-09 per hour
Mission time T <sub>M</sub>	20 years, EN ISO 13849-1
Category	4, EN ISO 13849

### Protective field data

Resolution	30 mm
Protective field height	1,350 mm

### Optical data

Number of beams	54 Piece(s)
Synchronization	Optical between transmitter and receiver

### Electrical data

Protective circuit	Overvoltage protection Short circuit protected
--------------------	---

### Performance data

Supply voltage U <sub>B</sub>	26.5 ... 31.6 V
Current consumption from AS-i circuit	150 mA

### Timing

Response time	13 ms
Restart delay time	100 ms

### Interface

Type	AS-Interface Safety at Work
<b>AS-i</b>	
Function	Process
AS-i profile	S-0.B.F
Slave address	1..31 programmable, default=0
Cycle time acc. to AS-i specifications	Max. 5 ms

### Connection

Number of connections	2 Piece(s)
<b>Connection 1</b>	
Function	Machine interface
Type of connection	Connector
Thread size	M12
Material	Metal
No. of pins	5 -pin

### Connection 2

Function	Cascade, Guest Out Cascade, Middle Guest Out
Type of connection	Cable with connector
Cable length	330 mm
Sheathing material	PUR
Thread size	M12
Material	Plastic
No. of pins	8 -pin

### Cable properties

Permissible conductor cross section, typ.	0.25 mm <sup>2</sup>
Length of connection cable, max.	100 m
Permissible cable resistance to load, max.	200 Ω

### Mechanical data

Dimension (W x H x L)	29 mm x 1,416 mm x 35.4 mm
Housing material	Metal
Metal housing	Aluminum
Lens cover material	Plastic / PMMA
Material of end caps	Diecast zinc
Net weight	1,575 g
Housing color	Yellow, RAL 1021
Type of fastening	Groove mounting Mounting bracket Swivel mount

### Operation and display

Type of display	LED
Number of LEDs	2 Piece(s)

### Environmental data

Ambient temperature, operation	0 ... 55 °C
Ambient temperature, storage	-30 ... 70 °C
Relative humidity (non-condensing)	0 ... 95 %

### Certifications

Degree of protection	IP 65
Protection class	III
Certifications	c CSA US c TÜV NRTL US TÜV Süd
US patents	US 6,418,546 B

### Classification

Customs tariff number	85365019
eCl@ss 5.1.4	27272704
eCl@ss 8.0	27272704
eCl@ss 9.0	27272704
eCl@ss 10.0	27272704
eCl@ss 11.0	27272704
ETIM 5.0	EC002549
ETIM 6.0	EC002549
ETIM 7.0	EC002549

## Dimensioned drawings

All dimensions in millimeters

Calculation of the effective protective field height  $H_{PFE} = H_{PFN} + B + C$

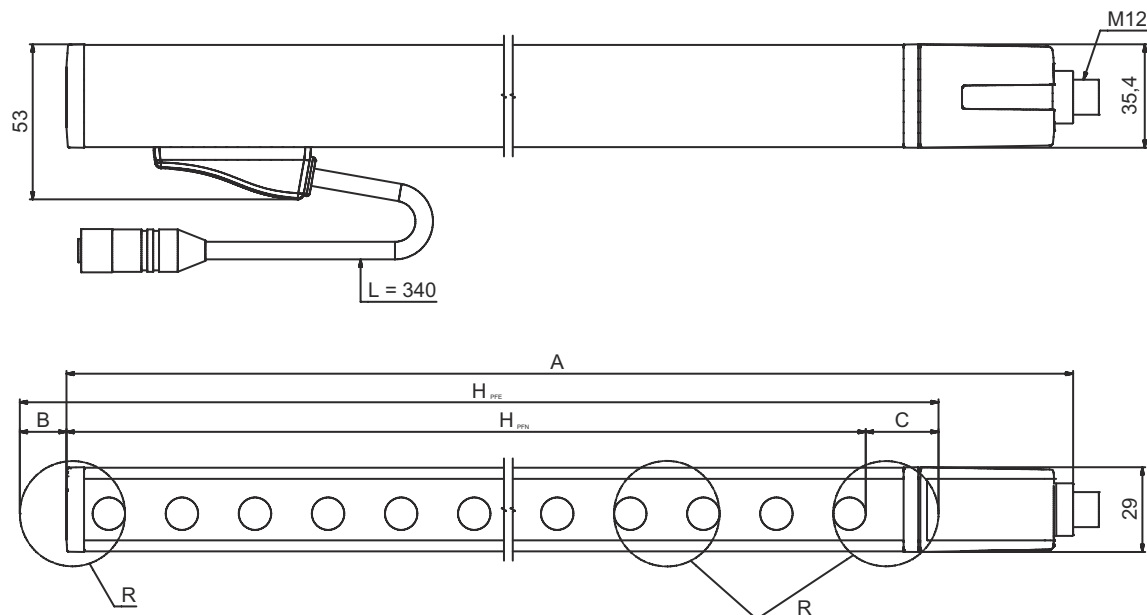

$H_{PFE}$  Effective protective field height = 1378 mm  
 $H_{PFN}$  Nominal protective field height = 1350 mm  
 A Total height = 1416 mm  
 B 19 mm

C 9 mm  
 R Effective protective field height  $H_{PFE}$  goes beyond the dimensions of the optics area to the outer borders of the circles labeled with R.

## Electrical connection

### Connection 1

Function	Machine interface
Type of connection	Connector
Thread size	M12
Type	Male
Material	Metal
No. of pins	5 -pin
Encoding	A-coded

### Pin Pin assignment

1	AS-i+
2	n.c.
3	AS-i-
4	n.c.
5	n.c.

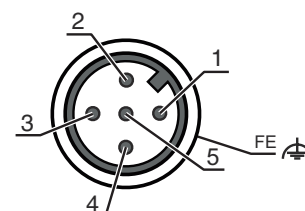

### Connection 2

Function	Cascade, Guest Out Cascade, Middle Guest Out
Type of connection	Cable with connector
Cable length	330 mm
Sheathing material	PUR
Cable color	Black

## Electrical connection

### Connection 2

Wire cross section	0.14 mm <sup>2</sup>
Type of stranding	Pair stranding (twisted pair)
Thread size	M12
Type	Female
Material	Plastic
No. of pins	8 -pin
Encoding	A-coded

## Operation and display

LED	Display	Meaning
1	Off	Device switched off
	Red, continuous light	Protective field interrupted
	Red, flashing, 1 Hz	External error
	Red, flashing, 10 Hz	Internal error
	Green, flashing, 1 Hz	Protective field free, weak signal
	Green, continuous light	Protective field free
2	Off	No voltage
	On	OSSD off, transmission channel C2
	Green, continuous light	AS-i slave communicating with AS-i master
	Red, continuous light	AS-i slave not communicating with AS-i master
	Yellow, flashing	AS-i slave has invalid address 0
	Red, flashing	AS-i slave device error or AS-i connection defective
	Red/green, flashing alternately	Periphery error

## Suitable transmitters

	Part no.	Designation	Article	Description
	68016313	MLC500T30-1350H/A	Safety light curtain transmitter	Resolution: 30 mm Protective field height: 1,350 mm Operating range: 0 ... 10 m Interface: AS-Interface Safety at Work Connection: Connector, M12, Metal, 5 -pin

## Part number code

Part designation: MLCxyy-za-hhhhei-ooo

MLC	Safety light curtain
x	<b>Series</b> 3: MLC 300 5: MLC 500
yy	<b>Function classes</b> 00: transmitter 01: transmitter (AIDA) 02: transmitter with test input 10: basic receiver - automatic restart 11: basic receiver - automatic restart (AIDA) 20: standard receiver - EDM/RES selectable 30: extended receiver - blanking/muting
z	<b>Device type</b> T: transmitter R: receiver
a	<b>Resolution</b> 14: 14 mm 20: 20 mm 30: 30 mm 40: 40 mm 90: 90 mm

## Part number code

MLC		Safety light curtain	
hhhh	<b>Protective field height</b>	150 ... 3000: from 150 mm to 3000 mm	
e	<b>Host/Guest (optional)</b>	H: Host MG: Middle Guest G: Guest	
i	<b>Interface (optional)</b>	/A: AS-i	
ooo	<b>Option</b>	/V: high Vibration-proof EX2: explosion protection (zones 2 + 22) SPG: Smart Process Gating	

**Note**



A list with all available device types can be found on the Leuze website at [www.leuze.com](http://www.leuze.com).

## Notes

 **Observe intended use!**



- The product may only be put into operation by competent persons.
- Only use the product in accordance with its intended use.

## Accessories

### Connection technology - Interconnection cables

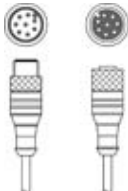
	Part no.	Designation	Article	Description
	429278	CB-M12-2000E-8TP	Interconnection cable	Connection 1: Connector, M12, Axial, Female, A-coded, 8 -pin Connection 2: Connector, M12, Axial, Male, A-coded, 8 -pin Shielded: Yes Cable length: 2,000 mm Sheathing material: PUR

### Mounting technology - Swivel mounts

	Part no.	Designation	Article	Description
	429393	BT-2HF	Mounting bracket set	Fastening, at system: Through-hole mounting Mounting bracket, at device: Clampable Type of mounting device: Turning, 360° Material: Metal, Plastic

## Accessories

## Services

	Part no.	Designation	Article	Description
	S981050	CS40-I-140	Safety inspection "Safety light barriers"	<p>Details: Checking of a safety light barrier application in accordance with current standards and guidelines. Inclusion of the device and machine data in a database, production of a test log per application.</p> <p>Conditions: It must be possible to stop the machine, support provided by customer's employees and access to the machine for Leuze employees must be ensured.</p> <p>Restrictions: Travel costs and accommodation expenses charged separately and according to expenditure.</p>
	S981046	CS40-S-140	Start-up support	<p>Details: For safety devices including stopping time measurement and initial inspection.</p> <p>Conditions: Devices and connection cables are already mounted, price not including travel costs and, if applicable, accommodation expenses.</p> <p>Restrictions: Max. 2 h., no mechanical (mounting) and electrical (wiring) work performed, no changes (attachments, wiring, programming) to third-party components in the nearby environment.</p>

### Note



A list with all available accessories can be found on the Leuze website in the Download tab of the article detailed page.