

## Technical data sheet

### Safety light curtain receiver

Part no.: 68002104  
MLC520R14-450

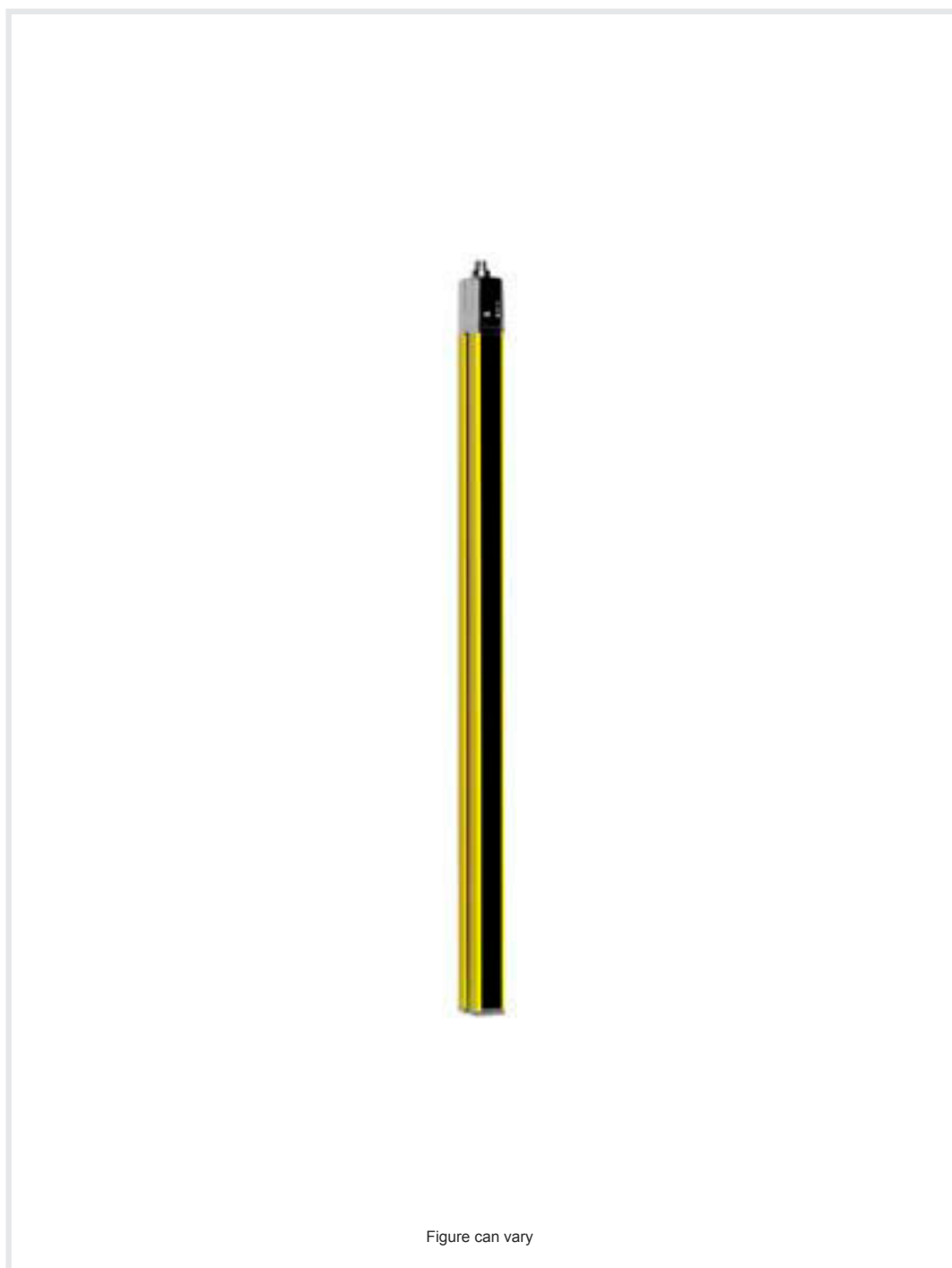

Figure can vary

#### Contents

- Technical data
- Dimensioned drawings
- Electrical connection
- Circuit diagrams
- Operation and display
- Suitable transmitters
- Part number code
- Notes
- Accessories



## Technical data

### Basic data

Series	MLC 500
Device type	Receiver
Contains	2x BT-NC sliding block
Application	Finger protection

### Functions

Function package	Standard
Functions	Contactormonitoring (EDM) Start/restart interlock (RES) Transmission channel changeover

### Characteristic parameters

Type	4, IEC/EN 61496
SIL	3, IEC 61508
SILCL	3, IEC/EN 62061
Performance Level (PL)	e, EN ISO 13849-1
PFH <sub>D</sub>	7.73E-09 per hour
Mission time T <sub>M</sub>	20 years, EN ISO 13849-1
Category	4, EN ISO 13849

### Protective field data

Resolution	14 mm
Protective field height	450 mm

### Optical data

Synchronization	Optical between transmitter and receiver
-----------------	--

### Electrical data

Protective circuit	Overvoltage protection Short circuit protected
--------------------	---

#### Performance data

Supply voltage U <sub>B</sub>	24 V, DC, -20 ... 20 %
Current consumption, max.	150 mA
Fuse	2 A semi time-lag

#### Inputs

Number of digital switching inputs	3 Piece(s)
------------------------------------	------------

#### Switching inputs

Type	Digital switching input
Switching voltage high, min.	18 V
Switching voltage low, max.	2.5 V
Switching voltage, typ.	22.5 V
Voltage type	DC

#### Outputs

Number of safety-related switching outputs (OSSDs)	2 Piece(s)
--	------------

### Safety-related switching outputs

Type	Safety-related switching output OSSD
Switching voltage high, min.	18 V
Switching voltage low, max.	2.5 V
Switching voltage, typ.	22.5 V
Voltage type	DC
Current load, max.	380 mA
Load inductivity	2,000 µH
Load capacity	0.3 µF
Residual current, max.	0.2 mA
Residual current, typ.	0.002 mA
Voltage drop	1.5 V

#### Safety-related switching output 1

Assignment	Connection 1, pin 5
Switching element	Transistor, PNP

#### Safety-related switching output 2

Assignment	Connection 1, pin 6
Switching element	Transistor, PNP

### Timing

Response time	11 ms
Restart delay time	100 ms

### Connection

Number of connections	1 Piece(s)
-----------------------	------------

#### Connection 1

Function	Machine interface
Type of connection	Connector
Thread size	M12
Material	Metal
No. of pins	8 -pin

#### Cable properties

Permissible conductor cross section, typ.	0.25 mm <sup>2</sup>
Length of connection cable, max.	100 m
Permissible cable resistance to load, max.	200 Ω

### Mechanical data

Dimension (W x H x L)	29 mm x 516 mm x 35.4 mm
Housing material	Metal
Metal housing	Aluminum
Lens cover material	Plastic / PMMA
Material of end caps	Diecast zinc
Net weight	600 g
Housing color	Yellow, RAL 1021
Type of fastening	Groove mounting Mounting bracket Mounting on Device Column Swivel mount

### Operation and display

Type of display	7-segment display LED
Number of LEDs	2 Piece(s)

## Technical data

### Environmental data

Ambient temperature, operation	-30 ... 55 °C
Ambient temperature, storage	-30 ... 70 °C
Relative humidity (non-condensing)	0 ... 95 %

### Certifications

Degree of protection	IP 65
Protection class	III
Certifications	c CSA US
	c TÜV NRTL US
	S Mark
	TÜV Süd
Vibration resistance	50 m/s <sup>2</sup>
Shock resistance	100 m/s <sup>2</sup>
US patents	US 6,418,546 B

### Classification

Customs tariff number	85365019
eCl@ss 5.1.4	27272704
eCl@ss 8.0	27272704
eCl@ss 9.0	27272704
eCl@ss 10.0	27272704
eCl@ss 11.0	27272704
ETIM 5.0	EC002549
ETIM 6.0	EC002549
ETIM 7.0	EC002549

## Dimensioned drawings

All dimensions in millimeters

Calculation of the effective protective field height  $H_{PFE} = H_{PFN} + B + C$



$H_{PFE}$  Effective protective field height = 462 mm

$H_{PFN}$  Nominal protective field height = 450 mm

A Total height = 516 mm

B 6 mm

C 6 mm

R Effective protective field height  $H_{PFE}$  goes beyond the dimensions of the optics area to the outer borders of the circles labeled with R.

## Electrical connection

### Connection 1

Function	Machine interface
Type of connection	Connector
Thread size	M12
Type	Male
Material	Metal
No. of pins	8 -pin
Encoding	A-coded
Connector housing	FE/SHIELD

# Electrical connection

Pin	Pin assignment	Conductor color
1	IO1	White
2	VIN1	Brown
3	IN3	Green
4	IN4	Yellow
5	OSSD1	Gray
6	OSSD2	Pink
7	VIN2	Blue
8	IN8	Red



## Circuit diagrams

### Connection diagram receiver

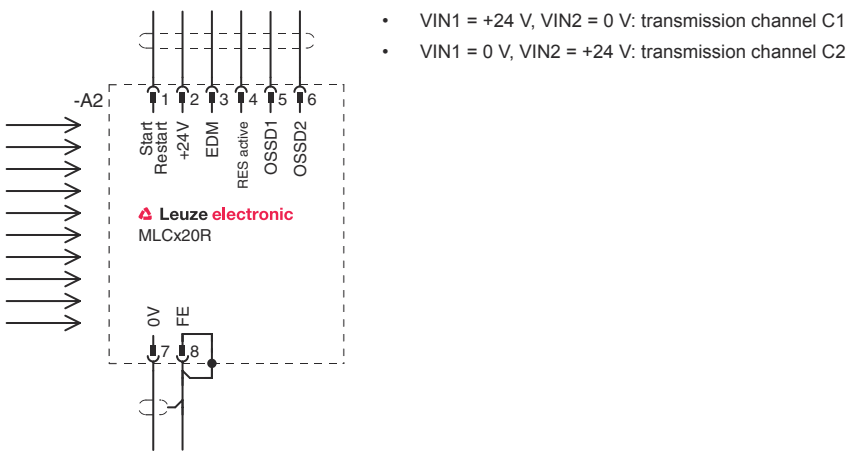

### Circuit diagram example with downstream MSI-RM2 safety relay

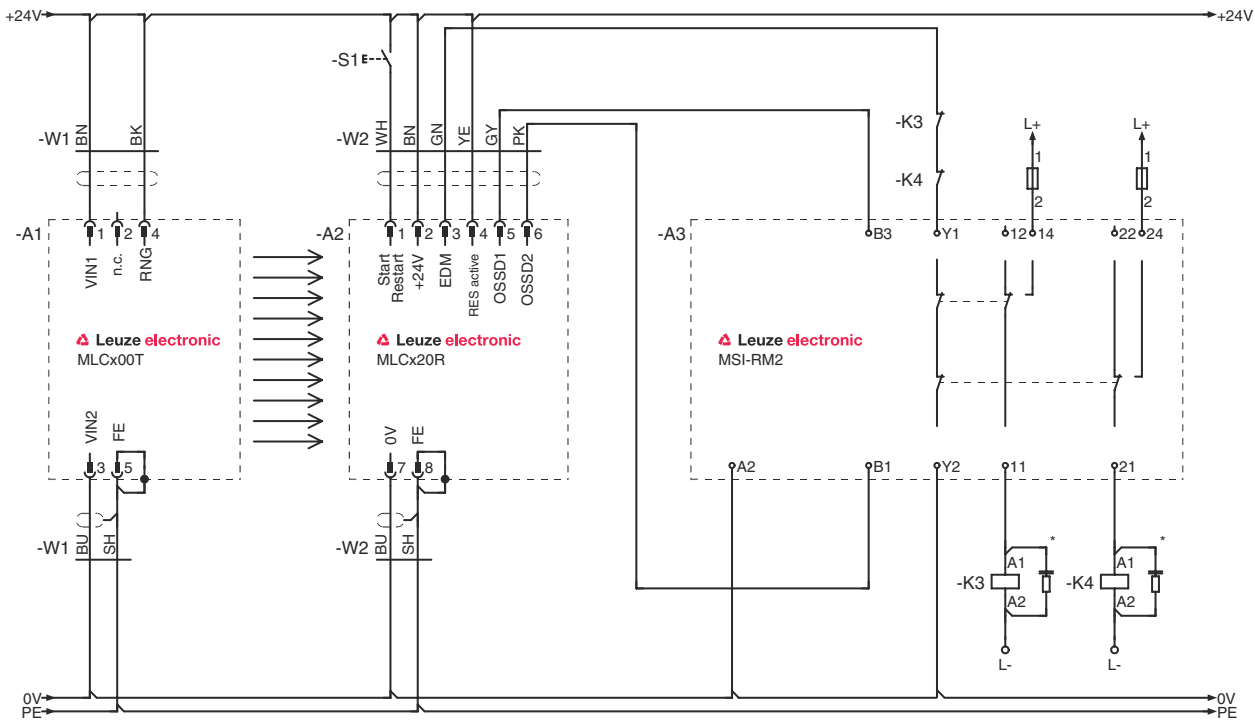

# Operation and display

LED	Display	Meaning
1	Off	Device switched off
	Red, continuous light	OSSD off
	Red, flashing, 1 Hz	External error
	Red, flashing, 10 Hz	Internal error
	Green, flashing, 1 Hz	OSSD on, weak signal
	Green, continuous light	OSSD on
2	Off	RES deactivated or RES activated and enabled or RES blocked and protective field interrupted
	Yellow, continuous light	RES activated and blocked but ready to be unlocked - protective field free and linked sensor is enabled if applicable

## Suitable transmitters

	Part no.	Designation	Article	Description
	68000104	MLC500T14-450	Safety light curtain transmitter	Resolution: 14 mm Protective field height: 450 mm Operating range: 0 ... 6 m Connection: Connector, M12, Metal, 5 -pin

## Part number code

Part designation: MLCxyy-za-hhhhei-ooo

MLC	Safety light curtain
x	<b>Series</b> 3: MLC 300 5: MLC 500
yy	<b>Function classes</b> 00: transmitter 01: transmitter (AIDA) 02: transmitter with test input 10: basic receiver - automatic restart 11: basic receiver - automatic restart (AIDA) 20: standard receiver - EDM/RES selectable 30: extended receiver - blanking/muting
z	<b>Device type</b> T: transmitter R: receiver
a	<b>Resolution</b> 14: 14 mm 20: 20 mm 30: 30 mm 40: 40 mm 90: 90 mm
hhhh	<b>Protective field height</b> 150 ... 3000: from 150 mm to 3000 mm
e	<b>Host/Guest (optional)</b> H: Host MG: Middle Guest G: Guest

## Part number code

**MLC**      **Safety light curtain**

i	<b>Interface (optional)</b> /A: AS-i
ooo	<b>Option</b> /V: high Vibration-proof EX2: explosion protection (zones 2 + 22) SPG: Smart Process Gating

Note	
	<p>↪ A list with all available device types can be found on the Leuze website at <a href="http://www.leuze.com">www.leuze.com</a>.</p>

## Notes

⚠ Observe intended use!	
	<p>↪ The product may only be put into operation by competent persons.</p> <p>↪ Only use the product in accordance with its intended use.</p>

## Accessories

### Connection technology - Connection cables

	Part no.	Designation	Article	Description
	50135128	KD S-M12-8A-P1-050	Connection cable	Connection 1: Connector, M12, Axial, Female, A-coded, 8 -pin Connection 2: Open end Shielded: Yes Cable length: 5,000 mm Sheathing material: PUR

### Mounting technology - Swivel mounts

	Part no.	Designation	Article	Description
	429393	BT-2HF	Mounting bracket set	Fastening, at system: Through-hole mounting Mounting bracket, at device: Clampable Type of mounting device: Turning, 360° Material: Metal, Plastic

## Accessories

## Services

	Part no.	Designation	Article	Description
	S981050	CS40-I-140	Safety inspection "Safety light barriers"	<p>Details: Checking of a safety light barrier application in accordance with current standards and guidelines. Inclusion of the device and machine data in a database, production of a test log per application.</p> <p>Conditions: It must be possible to stop the machine, support provided by customer's employees and access to the machine for Leuze employees must be ensured.</p> <p>Restrictions: Travel costs and accommodation expenses charged separately and according to expenditure.</p>
	S981046	CS40-S-140	Start-up support	<p>Details: For safety devices including stopping time measurement and initial inspection.</p> <p>Conditions: Devices and connection cables are already mounted, price not including travel costs and, if applicable, accommodation expenses.</p> <p>Restrictions: Max. 2 h., no mechanical (mounting) and electrical (wiring) work performed, no changes (attachments, wiring, programming) to third-party components in the nearby environment.</p>

### Note



A list with all available accessories can be found on the Leuze website in the Download tab of the article detailed page.