

1 INFORMATION ON THIS DOCUMENT

1.1 Function

The present operating instructions provide information on installation, connection and safe use for the following parts: **L300, AC-L300-xCA**

1.2 Target audience

The operations described in these operating instructions must be carried out by qualified personnel only, who are fully capable of understanding them, and with the technical qualifications required for operating the machines and systems in which the safety devices are to be installed.

1.3 Area of application

These operating instructions apply exclusively to the devices listed in section Function, and their accessories.

1.4 Original instructions

The German language version is the original set of operating instructions. Versions provided in other languages are translations of the original instructions.

2 SYMBOLS USED

 This symbol indicates any relevant complementary information

 Attention: Any failure to observe this warning note can cause damage or malfunction, including possible loss of the safety function.

3 DESCRIPTION

3.1 Device description

The safety device described in these operating instructions is defined as a coded, type-4 interlock device with guard interlocking and without contact acc. to EN ISO 14119.

The safety switches with electromagnet and RFID technology, for which these operating instructions apply, are safety devices for the monitoring of gates, safety doors, enclosures and all protective devices that safeguard the parts of machines with or without stopping time.



3.2 Intended use of the device

- The device described in these operating instructions is designed to be used on industrial machines for condition monitoring of movable protective devices.
- The direct sale of this device to the public is prohibited. Installation and use must be carried out by qualified personnel only.
- The use of the device for purposes other than those specified in these operating instructions is prohibited.
- Any use other than as expressly specified in this operating manual shall be considered unintended by the manufacturer.
- Also considered unintended use:
 - a) Using the device after having made structural, technical, or electrical modifications to it;
 - b) using the product in an area of application other than as described in section TECHNICAL DATA.

4 MOUNTING INSTRUCTIONS

 Attention: Installing a protective device is not sufficient to ensure personnel safety or compliance with machine safety standards or directives. Before installing a protective device, perform a specific risk analysis in accordance with the key health and safety requirements in the Machinery Directive. The manufacturer guarantees only the safe functioning of the device to which these operating instructions refer, and not the functional safety of the entire machine or system

4.1 Actuation directions

 The centring symbols  on the device and actuator must be aligned with each other.

4.2 Selection of the actuator type

 Attention: The switch is available with two RFID actuator types: one with a high coding level (part AC-L300-UCA) and one with a low coding level (part AC-L300-SCA). In the case where an actuator with a low coding level has been chosen, ensure that the additional specifications prescribed in section 7.2 of the EN ISO 14119:2013 standard are respected during installation.

 Attention: If the chosen actuator has a low level of coding, any other low level coded actuators present in the same place where the device has been installed must be segregated and kept under strict control in order to avoid any bypassing of the safety device. If new low level coded actuators are fitted, the original low level coded actuators must be disposed of or rendered inoperable.

 It is advisable to use actuators with a high coding level so as to make the installation safer and more flexible. This will render it unnecessary to screen the device, to fit it in non-accessible areas or to follow other prescriptions specified by the EN ISO 14119 standard for actuators with low coding level.

4.3 Selection of the operating principle

 Attention: The safety switch is available with two operating principles:

1. SLM24 operating principle (quiescent current principle – The locking element is held in the protective position by spring force): actuator locked if electromagnet is deactivated.
2. MLM24 operating principle (open circuit current principle – The locking element is held in the protective position by electromagnetic force): actuator locked if electromagnet is activated.

With the SLM24 operating principle (quiescent current principle), the actuator stays locked even if the machine is disconnected from the power supply. Therefore, if the machine has dangerous movements with inertia, inaccessibility to dangerous parts (actuator locked) is ensured, even in the event of a sudden power failure. On the contrary, if the machine structure allows a person to enter the danger area with the whole body and possibly end up being stuck inside the machine, the switch must be provided with an escape release button, in order to allow the trapped person to get out even in case of power failure.

With the MLM24 operating principle (open circuit current principle), the actuator stays locked only when the machine is connected to the power supply. Therefore, before choosing this operation principle, carefully evaluate all dangers deriving from sudden power failure with a possibly immediate actuator release.

The choice of SLM24 or MLM24 operating principle must always be made following a risk analysis of the specific application.

 In case of machines without inertia, i.e. with dangerous elements being immediately blocked as soon as the safety door is opened, for which a safety device with lock has been chosen merely to safeguard the production process, the quiescent current principle or the open circuit current principle can both be used.

4.4 Operating mode selection for activation of safety outputs

 Warning: the device is available with three different safety outputs activation modes:

- **Mode 1 (part L300-xxx-Mx1-xx):** safety outputs active if actuator is inserted and locked;
- **Mode 2 (part L300-xxx-Mx2-xx):** safety outputs active if actuator is inserted;
- **Mode 3 (part L300-xxx-Mx3-xx):** OS1 safety output active if actuator is inserted and locked and IS1 is active, OS2 safety output active if actuator is inserted and IS2 is active.

Mode 1 activates the OS safety outputs when the actuator is both inserted and locked, so that the actuator cannot be extracted with the safety outputs activated. In mode 1 the device is coded, type 4 (interlock with lock) acc. to EN ISO 14119.

In mode 2, the actuator can be locked/unlocked for special applications while still kept on the safety chain, typically for specific applications without stopping time, when the risk does not continue after the opening of the protective device. In mode 2 the device is coded, type 4 (interlock without lock) acc. to EN ISO 14119.

For specific applications, mode 3 provides a channel with "mode 1" functionality, and a channel with "mode 2" functionality. This allows emulation of electromechanical interlock devices with guard interlocking, without complex machine wiring modifications.

Using modes 2 and 3 must always follow a risk analysis on the specific application, with particular focus on the function of cascaded mode 3 devices.

4.5 Mounting the device

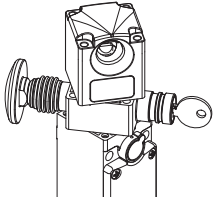

Before mounting the device: if necessary, it is possible to adjust the position of the head and the auxiliary release (if present) in order to turn the device to the most appropriate position for the specific application. Fully remove the 4 head screws in order to independently turn either the head or the auxiliary release over an arc of 270°.

⚠ Attention: Do not force rotation beyond 270° as this could cause damage to the device. Once adjustment is complete, re-tighten the head screws with a torque between 0.8 and 1.2 Nm.

Once the head of the device is in position, you must use the two safety screws supplied, in place of the two original screws, at opposite corners.

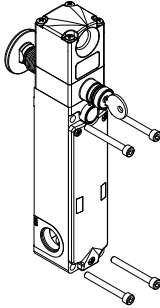

⚠ Attention: Always fix the device with 4 M5 screws with property class 8.8 or higher, and flat seating heads. Install the screws with medium thread lock, and a number of threads engaged equal to or greater than the screw diameter. The device must never be fixed with less than 4 screws. Tighten the 4 M5 screws to a torque from 2 to 3 Nm.

i It is advisable to install the device in the top part of the door, in order to prevent any dirt or work residues from getting inside the hole where the actuator is to be introduced. In order to avoid device bypassing, it is advisable to fix the device housing to the machine frame so that it cannot be removed.

4.6 Mounting the actuator to the protective device

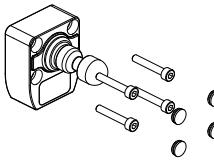

⚠ Attention: As required by EN ISO 14119, the actuator must be fixed immovably to the door frame.

Always fix the actuator with 4 M5 screws with property class 8.8 or higher, and flat seating heads. Install the screws with medium thread lock, and a number of threads engaged equal to or greater than the screw diameter. The actuator must never be fixed with less than

4 screws. Tighten the 4 M5 screws to a torque from 2 to 3 Nm.

After the fixing operation, it is mandatory to plug the holes of the 4 screws using the caps supplied. Using the caps is considered a supplementary measure to reduce the potential of actuator disassembly to a minimum, in accordance with EN ISO 14119.

For correct mounting, other means can also be used, such as rivets, non-removable one-way security screws or other equivalent mounting systems, as long as they can ensure adequate mounting.

4.7 Device-actuator alignment

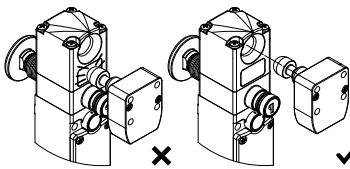

⚠ Attention: Although the device is designed to facilitate alignment between the device and actuator, excessive misalignment could damage the device. Periodically check the correct alignment between the safety device and its actuator.

Maximum misalignment permitted from the hole axis for rigid doors: ± 2 mm vertical and horizontal.

The actuator must not hit the outside of the actuator inlet area, and must not be used as a centering device for the safety door.

In the case of application on swing doors, check that the radius between the axis of the actuator and the axis of the hinge fitted on the door is greater than 150 mm.

Do not use a hammer for the adjustments, unscrew the screws and adjust the device manually, then tighten it in position.

This device is not suitable for applications in which the protective device with the permanently attached actuator allows misalignments such as the actuator shaft not entering through the corresponding hole of the device with the door completely closed.

i The device is provided with a through hole for inserting the actuator. In the case where it is used in dusty places, make sure not to obstruct the outlet hole opposite the inlet hole. This way, any dust which may go inside the hole will always be allowed to come out of the opposite side.

4.8 Escape release button

Some of the device versions are provided with an escape release button in order to allow any personnel accidentally trapped inside the machine to get out. This button, complying with the EN ISO 14119 standard, directly acts on the lock mechanism and immediately releases the actuator regardless of the operating state of the device. Pressing this button causes:

- In mode 1: immediate deactivation of the OS1, OS2 safety outputs and of the O4 signal output;
- In mode 2: immediate deactivation of the O4 signal output only;
- In mode 3: immediate deactivation of the OS1 safety output and of the O4 signal output.

i This escape release button unlocks the protective device even if the device is not powered on.

For correct installation of the escape release button, the following notes must be observed.

- The escape release button must be clearly visible from inside the machine.
- Button activation must be easy, immediate and independent from the machine operating state; for easier recognition of the button and explanation of its function, stickers are available in various languages.
- For an operator standing outside the machine, the escape release button must not be within immediate reach when the safety door is closed.
- To guarantee correct operation and safe resetting, a distance ranging from 10 to 35 mm must be kept between the wall on which the button is mounted and the escape release button.
- The release button sliding area is to be kept clean. Any ingress of dirt or chemical substance can compromise device operation.
- The personnel concerned must be adequately trained on correct button operation, so as to avoid any improper use (i.e. the button must not be used as a clothing hook).
- The escape release button must not be used as a machine emergency stop.

For installation on walls thicker than 20 mm, extensions are available for the release button.

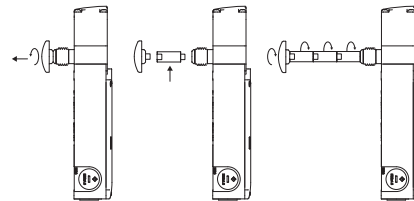

For correct installation of the extensions, the following notes must be observed:

- Do not exceed an overall length of 500 mm between the release button and the device;
- Always use medium screw locking adhesive on every screw connection between button, extensions, and safety device;
- Avoid twisting or bending the release button, if necessary use an appropriate sliding guide (pipe or bush) when the button and its extensions exceed a length of 100 mm;
- Tightening torque for button and extensions from 4 to 5 Nm.

4.9 Auxiliary release with a tool or lock

Some of the device versions are provided with an auxiliary release in order to allow easy installation (release with a screwdriver) or to permit opening for authorized personnel only (lock release). Both these mechanical release devices act inside the safety device like the escape release button previously described. Therefore they also unlock the protective device in case of power failure. These auxiliary release may only be operated by qualified personnel who has received adequate training on the dangers deriving from their use.

4.9.1 How to use the auxiliary release with a screwdriver

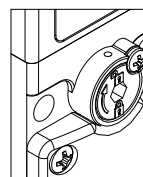

- Unscrew the locking screw with a PH1 cross-head screwdriver
- Turn the hexagon socket clockwise by 180°
- Do not force the hexagon socket beyond 180°
- To avoid any improper use of the auxiliary release with a tool, it is advisable to seal the device through the appropriate hole found in the upper part, or to seal the screw cross head with a few drops of paint.
- After each actuation, it is advisable to reseal the device.

4.9.2 How to use the auxiliary release with lock

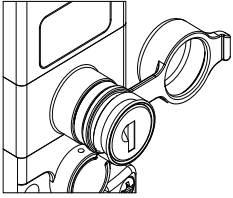

- Open the protection cap.
- Insert the key supplied with the device and turn clockwise by 180°.
- Do not force the key beyond 180°.
- Each time the key is extracted, close the rubber cap.
- The release key must only be made available to the machine maintenance engineer and kept in a secluded place.
- The release key must not be made available to the machine operator.

machine operator.

- Never leave the release key inserted in the device during normal machine operation.

i For particular applications, versions are available without any auxiliary release device.

4.10 Electrical connections of the device

All L300 device models are supplied with a wire bridge between IE1 (pin 8) and IE2 (pin 9) of the internal terminal strip. This means that they are preset for "single-channel activation of the electromagnets" via I4 (pin 3 of the internal terminal strip). If this wire bridge is removed, electromagnet activation via IE1 and IE2 is mandatory.

! Attention: The device is fitted with OSSD type semiconductor electronic safety outputs. These outputs behave differently from electromechanical contacts. Use and installation of a safety device with semiconductor outputs is only permitted if all characteristics of this particular type of outputs are known in detail.

4.10.1 Internal terminal strip for devices with standard cover

To open the device cover, use a PH2 cross-head screwdriver, and tighten the screws to a torque between 0.8 and 1.2 Nm.

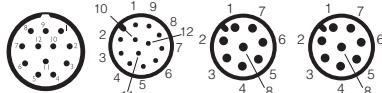
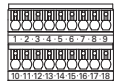

Internal terminal strip for switches	Connection		M12 connector, 12-pin			
			M23 connector, 12-pin	M12 connector, 12-pin	M12 connector, 8-pin Stand-alone connection	M12 connector 8-pin Series connection with Y-connectors
1	A2	Power supply input 0 V	3	3	3	3
2	B2	Auxiliary power supply output 0 V	3	3	3	3
3	I4	Input for activation of the electromagnet in single-channel operation (c)	10	10	8	8
4	O3	Signal output for inserted actuator (d)	5	5	2	/
5	O4	Signal output for inserted and locked actuator (b) (d)	9	9	5	5
6	I3	Actuator programming input / reset	8	8	6	/
8	IE1	Input for activation of the electromagnet in two-channel operation	10	10	/	/
9	IE2	Input for activation of the electromagnet in two-channel operation	12	12	/	/
10	A1	Power supply input +24 VDC	1	1	1	1
11	B1	Auxiliary power supply output +24 VDC, max. 8 A	1	1	1	1
12	IS1	Safety input	2	2	/	2
13	IS2	Safety input	6	6	/	6
14	I5	EDM input (a)	11	11	/	/
15	OS1	Safety output	4	4	4	4
16	OS2	Safety output	7	7	7	7

Attention: terminals 7, 17, 18, of the internal terminal strip must not be used.

(a) Only L300-xxx-M5x version available.

(b) For article L300-xxx-M6x, the output signals the error state of the device.

(c) In single-channel actuation mode, inputs IE1 and IE2 must be short-circuited.

(d) For article L300-xxx-M7x, the O3 and O4 signal outputs have negative function logic (active signal low).

4.10.2 Internal terminal strip for devices with integrated command devices

The switch can be supplied with a cover equipped with one to three integrated command devices. The following table illustrates the standard connections for these devices. Other configurations are available on request.



Internal terminal strip for integrated command devices (a)	Connection		
19	Contact 1	Device 1	
20			
21			
22	Contact 2	Device 1	
23			
24	Contact 1	Device 2	
25			
26	Contact 2	Device 2	
27			
28	Contact 1	Device 3	
29			
30	Contact 2	Device 3	
31			
31	Power supply input +24 VDC / device 1 LED		
32	Power supply input +24 VDC / device 2 LED		
33	Power supply input +24 VDC / device 3 LED		
34	Power supply input 0 V / LED		

(a) terminals 1-16, see section 4.10.1

4.10.3 Switch with integrated command devices and cable inlet

L300-Bx-xxxC3		
3 command devices	2 command devices	1 command device

4.10.4 Switch with integrated command devices and M23 connector, 19-pin



M23 connector, 19-pin	Connection		
19	A2	Power supply input 0 V	
19	B2	Auxiliary power supply input 0 V	
1	I4	Input for activation of electromagnet (c)	
8	O3	Signal output for inserted actuator (d)	
9	O4	Signal output for inserted and locked actuator (b) (d)	
7	I3	Programming input for teaching in a new code	
6	A1	Power supply input +24 VDC	
6	B1	Auxiliary power supply output +24 VDC, max. 8 A	
2	IS1	Safety input	
3	IS2	Safety input	
12	I5	EDM input (a)	
4	OS1	Safety output	
5	OS2	Safety output	
17	Contact 1	Device 1	
6			
/	Contact 2	Device 1	
/			
15	Contact 1	Devices 2	
6			
/	Contact 2	Devices 2	
/			
10	Contact 1	Devices 3	
11			
13	Contact 2	Devices 3	
14			
18	Power supply input +24 VDC / device 1 LED		
16	Power supply input +24 VDC / device 2 LED		
/	Power supply input +24 VDC / device 3 LED		
19	Power supply input 0 V / LED		

Attention: terminals 7, 17, 18, of the internal terminal strip must not be used.

(a) Only L300-xxx-M5x version available.

(b) For article L300-xxx-M6x, the output signals the error state of the device.

(c) IE1 and IE2 are not available for this connector version.

(d) For article L300-xxx-M7x, the O3 and O4 signal outputs have negative function logic (active signal low).

signal low).

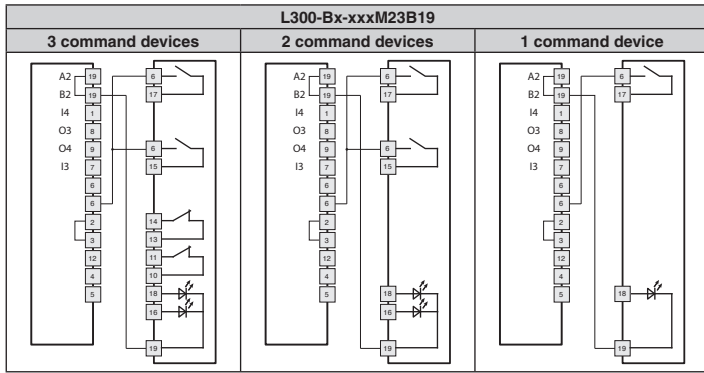

4.11 RFID sensor switching points

The RFID sensor on the device recognizes the actuator when placed in front of it. Within this field, the O3 signal output and the ACT LED are activated to signal the "protective device closed" state. In this state, it is possible to obtain protective device locking via the I4 (or IE1/IE2) input. After the locking operation, the LOCK LED and the O4 output are activated; at the same time the RFID sensor increases its switching distance, so as to ensure that no vibrations or impacts occurring with the protective device locked may cause the OS1, OS2 and O4 outputs to open accidentally. If the I4 input (or IE1/IE2) is activated or deactivated, without the actuator being present, the device does not carry out any locking and does not activate any of the OS1, OS2, or O4 outputs. In order to open the protection, I4 input (or IE1/IE2) must be used; with the protection released, the O4 output will be deactivated and the LOCK LED will be switched off. At this point, the RFID sensor will bring its intervention distance back to the initial values and, after the protective device has been opened, the O3 output and the ACT LED will be deactivated.

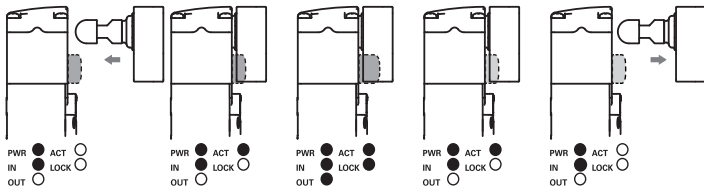

5 OPERATION

5.1 Access monitoring

These safety devices alone are not sufficient to protect any operators or maintenance engineers in the event of fully entering the danger zone, since any unintentional closing of a safety door behind them could allow the machine to be restarted. In case the machine restarting control is entirely entrusted to these switches, a device must be provided to avoid that risk, such as a lock-out/tag-out system which stops the machine from being restarted. A specifically designed lock-out/tag-out device is available as an accessory for this safety switch, which prevents any unintentional machine start up with the operator still inside (AC-L300-SH-LCK1-A3-P safety door handle; part number 50133287).

5.2 Definitions

Switch operating states:

- OFF: the device is off, not powered.
- POWER ON: status immediately following switching on, when the device carries out internal tests.
- RUN: status in which the device works normally.
- ERROR: error status in which the safety outputs are deactivated. Indicates that a fault is present inside or outside the device, such as:
 - short circuit between safety outputs (OS1 and OS2),
 - short circuit between a safety output and ground,
 - short circuit between a safety output and the supply voltage,
 - excessive misalignment between a switch and a locked actuator,
 - excess of maximum holding force with failure of the relating device in locked condition,
 - excess of maximum or minimum ambient temperature admitted,
 - internal error.

- The safety functions are defined as follows.

- Mode 1:
 - 1.1 The OS safety outputs must be deactivated when the actuator is detected as unlocked.
 - 1.2 The OS safety outputs must be deactivated when the actuator is no longer detected.
 - 1.3 The OS safety outputs must be deactivated when at least one safety input (IS1 or IS2) is not active.
- Mode 2:
 - 2.1 The OS safety outputs must be deactivated when the actuator is no longer detected.
 - 2.2 The OS safety outputs must be deactivated when at least one safety input (IS1 or IS2) is not active.
- Mode 3:
 - 3.1 The OS1 safety output must be deactivated when the actuator is detected as unlocked.
 - 3.2 The OS2 safety output must be deactivated when the actuator is no longer detected.
 - 3.3 The OS1 safety output must be deactivated when the IS1 safety input is not active.
 - 3.4 The OS2 safety output must be deactivated when the IS2 safety input is not active.

In all operating modes, the device must keep the protective device closed and locked when the electromagnet is active (MLM24 operating principle) or inactive (SLM24 operating principle) and the applied force is lower than the declared FZh value.

- External Device Monitoring (EDM) is a function (available depending on the device model) that allows the device to monitor the state of external contactors. Activation and deactivation of external contactors must follow the state of the L300 switch safety outputs within a maximum delay.

5.3 Operation description

Note: The following operation description refers to a device with safety outputs active when the protection is closed and locked (mode 1).

A device with safety outputs activated by closing the protective device (mode 2) differs from the above operating mode for the fact that the safety outputs OS1 and OS2 are activated without the f4 function verifying the protective device locking.

Mode 3 differs, in that OS1 is activated when the protective device is closed and locked, and OS2 with protective device closed.

After being correctly installed by following the present instructions, the safety device can be supplied with power. The block diagram below shows 5 logically linked sub-functions of the safety device.

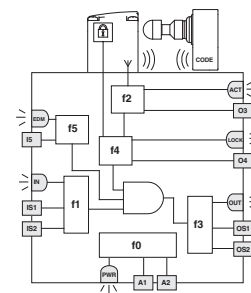

In the initial "POWER ON" status, function f0 of the safety device carries out an internal self-diagnosis which, if successfully completed, brings the device to the "RUN" operating state. If the test is not passed due to an internal fault, the device enters the "ERROR" status.

On EDM versions, at power on, the EDM signal is checked and it must be active within 500 ms from device startup. If the EDM signal is not present after this time span has elapsed, function f5 puts the device in the "FAULT" operating state.

The "RUN" operating state indicates normal operation: Function f1 evaluates the state of the IS1 and

IS2 inputs, while at the same time function f2 checks that the actuator is present, and function f4 checks that the actuator has been locked.

In the EDM versions the f5 function verifies the coherence of the EDM signal during operating state changes and when the safety outputs are off.

When these three conditions occur, function f3 of the device activates the OS1 and OS2 safety outputs.

The IS1 and IS2 inputs of the device are usually actuated simultaneously and therefore they are monitored, in terms of their state and their coherence. The device deactivates the safety outputs and signals the state of non-coherent inputs by means of IN LED green/orange flashing, in the case where only one of the two inputs is deactivated. In order to reactivate the safety outputs, both inputs have to be deactivated and subsequently reactivated.

During the RUN state, function f0 cyclically carries out internal tests in order to detect any faults. Any internal error being detected brings the device to the "ERROR" state (PWR LED with red fixed light), which immediately deactivates the safety outputs.

The "ERROR" state can be reached even in the case of short circuits occurring between the safety outputs (OS1 and OS2) or a short circuit of an output towards earth or towards the power supply. Also in this case, function f3 deactivates the safety outputs, and the error status is indicated by the OUT LED red flashing light.

The O3 signal output is activated during the "RUN" state when the actuator is inserted in the device, regardless of the state of the IS1 and IS2 inputs. The state of this output is displayed by means of the ACT LED.

The O4 signal output is activated during the "RUN" state when the actuator has been inserted and locked inside the device, regardless of the state of the IS1 and IS2 inputs. The state of this output is displayed by means of the LOCK LED.

The actuator lock or unlock command is transmitted to the device through the I4 input. I3 input has different functions, depending on the state of the L300:

- Actuator inserted but not locked: I3 activates the "Teaching an actuator" function (see section 5.4).
- L300 in error state: I3 activates the reset function (see section 5.5)
- Actuator inserted and locked: I3 without function.

5.4 Actuator replacement

Attention: The machine manufacturer must restrict access to the sensor programming mode to authorized personnel only.

The I3 input can be used, at all times, to replace the coded actuator with a second actuator. By activating this input, the device gets ready for programming mode with the IN LED orange light flashing, it deactivates all the OS1, OS2, O3 and O4 outputs and then releases the actuator. Keep the input active while inserting the second actuator. Acquisition of the second actuator is confirmed by the IN LED switching off and by four flashes of the ACT LED. At this point, it is possible to deactivate the I3 input. The device will automatically be brought to the restart state and the first actuator is no longer detected.

The second actuator will have to be adequately fixed to the protective device as explained in section MOUNTING INSTRUCTIONS.

This operation must not be carried out as a repair or maintenance operation. In the case where the device stops working correctly, replace the entire device and not just the actuator.

5.5 Reset input

The following error states due to a device external failure can be reset using the I3 input:

- a short circuit or overload of safety outputs (OS1 and OS2),
- short circuit between a safety output and the supply voltage,
- excessive misalignment between a safety device and a locked actuator.

5.6 Series connection with safety modules

It is possible to install several devices in cascade connection up to a maximum number of 32 units, while maintaining safety category 4 / PL e according to EN ISO 13849-1 and SIL CL 3 integrity level according to EN 62061.

Check that the PFHd and MTTFd values of the system comprising the series connection of devices and the whole safety circuit meet the SIL/PL requirements prescribed for the application.

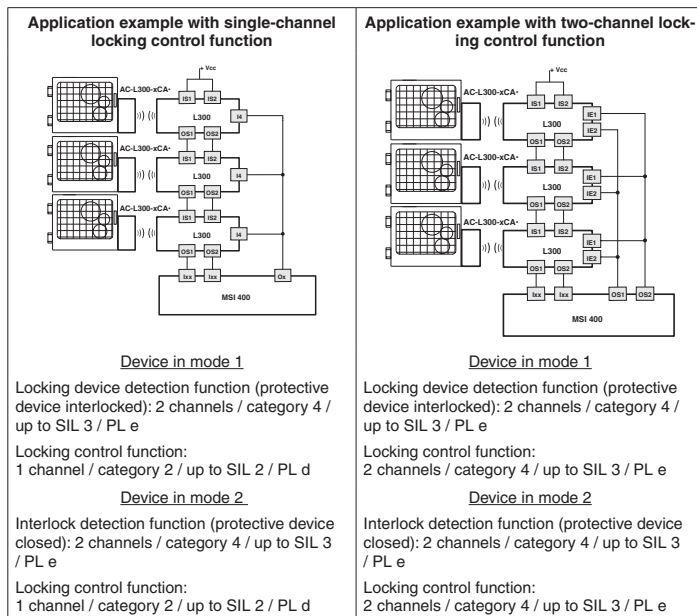

When connecting the devices in series as described above, observe the following:

- Connect the inputs of the first device in the chain to the power supply.
- The OS1 and OS2 safety outputs of the last device in the chain must be connected to the safety circuit of the machine.
- Where a safety module is used, check that the properties of OS1/OS2 safety outputs are compatible with the safety module inputs (see section INTERFACING).
- Observe the limits of the output cable stray capacitance, as specified in the electrical data (see section TECHNICAL DATA).
- Check that the cascade response time fulfills the requirements of the safety function to be obtained.
- The chain response time must be calculated taking into account the response time of each device.
- When using Y-cables for series connection, special attention must be paid to the flowing currents, cable cross-sections and cable lengths in order to ensure that the supply voltage of the components at the end of the series connection is within the specified electrical limits of the L300 during operation.

5.7 Operating states

PWR LED	IN LED	OUT LED	ACT LED	LOCK LED	EDM ^a	Device status	Description
O	O	O	O	O	O	OFF	Device switched off.
Flashing green/red	Flashing green/red	Flashing green/red	Flashing green/red	Flashing green/red	Flashing green/red	POWER ON	Internal tests at switching on.
Green	O	O	*	*	Green	RUN	Safety inputs of the device not active.
Green	Green	*	*	*	*	RUN	Activation of safety inputs.
Green	Green / orange, flashing	O	*	*	*	RUN	Noncoherent safety inputs. Recommended action: check input signal activation and/or wiring of inputs.

PWR LED	IN LED	OUT LED	ACT LED	LOCK LED	EDM ^a	Device status	Description
Green	*	*	Green	*	*	RUN	Actuator in safe area. O3 signal output active.
Green	*	*	*	Red, flashing	*	RUN	Noncoherent inputs IE1 and IE2 for electromagnet activation. Recommended action: check input signal activation and/or wiring of inputs.
Green	*	*	Green	Green	O	RUN	Actuator in safe area and locked, O3 and O4 outputs active.
Green	Green	Green	Green	Green	O	RUN	Mode 1: activation of IS1 and IS2 safety inputs. Actuator in safe area and locked, O3, O4, OS1 and OS2 outputs active.
Green	Green	Green	Green	*	O	RUN	Mode 2: activation of IS1 and IS2 safety inputs. Actuator in safe area, O3, OS1, and OS2 outputs active.
Green	Orange	Orange	Green	Green	O	RUN	Mode 3: Actuator present, protective device closed and locked, IS1 active, IS2 not active, OS1 active, OS2 not active
Green	Green	Orange	Green	O	O	RUN	Mode 3: Actuator present, protective device closed and not locked, IS1 and IS2 active, OS1 not active, OS2 active
Green	*	Red, flashing	*	*	*	ERROR	Error on safety outputs. Recommended action: check for any short circuits between the outputs, outputs and ground or outputs and power supply, then restart the device.
Green	O	O	Red, flashing	O	O	ERROR	Actuator detection error. Check for physical integrity of the device. In case of damage, please replace the entire device. If undamaged, realign the actuator and restart the device.
Red	O	O	O	O	O	ERROR	Internal error. Recommended action: restart the device. If the fault persists, replace the device.
Red, flashing	O	O	O	O	O	ERROR	Temperature error: outside the permissible range
Green	*	O	*	*	Green	RUN	EDM signal active (external relay off) ^a
Green	Green	Green	Green	Green	O	RUN	EDM signal not active (external relay on) ^a
Green	O	O	O	O	Red, flashing	ERROR	Error in EDM function ^a

O = off * = indifferent (a) = only available with the L300-xx-M5xx version

5.8 Interfacing

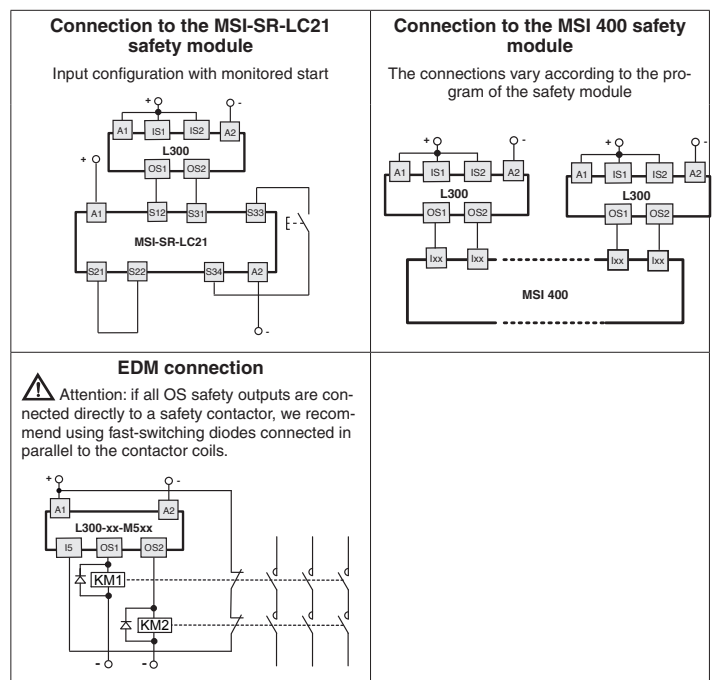

6 INSTRUCTIONS FOR PROPER USE

6.1 Installation

 Attention: The installation must exclusively be carried out by qualified personnel. The OS1 and OS2 safety outputs of the device must be connected to the safety circuit of the machine. The O3 and O4 signal outputs are not safety outputs and cannot be used individually in a safety circuit to determine the "protection closed" state.

- Do not stress the device with bending and torsion.
- Do not modify the device for any reason whatsoever.
- Do not exceed the tightening torques specified in the present operating instructions.
- The device carries out a personnel protection function. Any inadequate installation or tampering can cause people serious injuries and even death as well as property damage and financial losses.
- These devices must not be bypassed, removed, turned or disabled in any other way.
- If the machine where the device is installed is used for a purpose other than the intended use, the device may not provide efficient personnel protection.
- The safety category of the system (according to EN ISO 13849-1), including the safety device, also depends on the external devices connected to it and their type.
- Before installation, make sure the device is not damaged in any part.
- Before installation, ensure that the connection cables are not powered.
- Avoid excessive bending of connection cables in order to prevent any short circuits or power failures.
- Do not paint or varnish the device.
- Do not drill the device.
- Do not use the device as a support or rest for other structures, such as cable ducts or sliding guides.
- Before commissioning, make sure that the entire machine (or system) complies with all applicable standards and EMC directive requirements.
- The device fitting surface must always be smooth and clean.
- Should the installer be unable to fully understand the documents, the product must not be installed and the necessary assistance may be requested from the manufacturer (see section SUPPORT).
- Check for correct switching of the outputs and correct operation of the system comprising the device and associated safety module before commissioning the machine and in regular intervals.
- In proximity of the device do not carry out arc welding, plasma welding, or any other process that may generate electromagnetic fields of intensity higher than the limits prescribed by the standards, even when the device is off. Where welding operations are to be carried out in the proximity of the previously installed device, it must first be moved away from the work area.
- When the device is installed on a mobile door frame and the actuator is installed on a mobile door, check that the device isn't damaged by simultaneous opening of the frame and the door.
- After installation, check for correct operation of the auxiliary release (if present) and the escape release button.
- Always attach these operating instructions to the manual of the machine in which the device is installed.
- These operating instructions must be kept available for consultation at any time and for the whole period of use of the device.

6.2 Not to be used in the following areas

- An environment where continuous temperature changes cause condensation inside the device.
- An environment where the application causes the device to be subject to strong impact or vibration.
- An environment where explosive or flammable gases are present.
- An environment where the device may become coated with ice.
- An environment containing strongly aggressive chemicals, where the products coming into contact with the device may impair its physical or functional integrity.

6.3 Mechanical limit stop

 Attention: The door must always be provided with an independent mechanical limit stop at the end position.

Do not use the device as mechanical limit stop for the door.

6.4 Maintenance and function tests

 Attention: Do not disassemble or try to repair the device. In case of any malfunction or fault, replace the entire device.

 Attention: In case of any damage or wear, the entire device with actuator must be replaced. Correct operation cannot be guaranteed when the device is deformed or damaged.

- The device installer is responsible for establishing the sequence of function tests to which the installed device is to be subjected to before machine commissioning and during maintenance intervals.
- The testing sequence can vary according to machine complexity and circuit

diagram, therefore the functional test sequence detailed below is to be considered as minimal and not exhaustive.

- Perform the following sequence of checks before the machine is commissioned and at least once a year (or after a prolonged shutdown):
1. Lock the protective device and start the machine. It must be impossible for the protective device to be opened.
 2. Try to start the machine while the protective device is open. The machine must not start.
 3. Check correct actuator to device alignment. If the actuator insertion opening is worn, replace the entire device and actuator assembly.
 4. When the escape release button (if present) is pressed, the protective device must open freely and the machine must not start. Each time the escape release button is activated, the machine must stop and the safety door must open immediately. The escape release button must slide freely and be tightly screwed in. The signs placed inside the machine, indicating the function of the escape release button (if fitted), must be intact, clean and clearly readable.
 5. When the auxiliary release (if present) is activated, the protective device must open freely and the machine must not start (for devices with mode 3, check that the machine shows the expected behavior)
 6. If the protective device is closed but not locked, it must not be possible for the machine to start (not applicable in mode 2, for devices with mode 3, check that the machine shows the expected behavior).
 7. All external parts must be undamaged.
 8. If the device is damaged, replace it completely.
 9. The actuator must be securely locked to the safety door. Check that none of the operating personnel's tools can be used to disconnect the actuator from the door.
 10. The device has been created for applications in dangerous environment, therefore its mission time is limited. 20 years after its production date, the device must be totally replaced, even when still working. The production date is placed next to the part number (see section MARKINGS).

6.5 Wiring

 Attention: Check that the supply voltage is correct before powering the device.

- Keep the loading within the reference values of the respective electrical usage categories.
- Only connect and disconnect the device when the power is off.
- Discharge static electricity before handling the product, by making contact with a metal mass connected to earth. Any strong ESD could damage the device.
- Power the safety device and other connected components from one single SELV-type source and in conformity with the relevant standards.
- Always connect the protection fuse (or equivalent device) in series with the power supply for each device.
- During and after mounting, do not pull the electrical cables connected to the device.
- At the end of the wiring, check that no contaminating element has been introduced inside the device.
- Before closing the housing cover verify the correct positioning of the gaskets.
- Verify that the cables, wire-end sleeves, cable numbering systems and any other parts do not obstruct the cover from closing correctly or if pressed between them do not damage or compress internal parts.
- During and after mounting, do not pull the electrical cables connected to the device. If traction is applied to the cables (not supported by an appropriate cable gland), internal parts of the device may be damaged.
- The device contains two PUSH-IN spring-operated terminal strips for connecting the following electrical leads.

The cross section of wires or leads with wire-end sleeves:
at least 0.34 mm² (AWG 22) and no more than 1.5 mm² (AWG 16).

The cross section of leads with welded-on wire-end sleeves:
at least 0.34 mm² (AWG 22) and no more than 0.75 mm² (AWG 18).

Stripping length of electrical leads: min. 8 mm - max. 12 mm.

6.6 Additional prescriptions for safety applications with personal protection functions

Provided that all previous prerequisites are fulfilled, and the devices installed are intended to ensure personnel protection, the following additional regulations are also to be observed.

Device operation implies the knowledge and observation of the following standards: EN 60947-5-3, EN ISO 13849-1, EN 62061, EN 60204-1, EN ISO 14119, EN ISO 12100.

6.7 Limitations of use

- By connecting the two electromagnet activation inputs IE1, IE2 on two distinct channels to two OSSD safety outputs of a safety PLC or safety module, the device can be used as a component with interlocking functions in a safety system with safety category 4 /PL e according to EN ISO 13849-1 and safety integrity level SIL CL 3 according to EN 62061.
- By connecting both electromagnet activation inputs IE1 and IE2 to the same channel, or by connecting the I4 input only after having short-circuited the two electromagnet activation inputs IE1 and IE2, the device can be used as a component with locking functions in a safety system with safety category 2 / PL d according to EN ISO 13849-1 and safety integrity level SIL CL 2 according to EN 62061. Any fault on the single I4 activation line of the electromagnets can cause the actuator to be released, and the safety outputs switched off.
- Use the device following the operating instructions, complying with its operation

limits and the valid safety regulations.

- The devices have precise application limitations (minimum and maximum ambient temperature, mechanical working life, IP degree of protection, etc.) Each of these limitations must be met by the device.
- The manufacturer's liability is to be excluded in the following cases:
 1. Use not conforming to the intended purpose;
 2. Failure to adhere to these instructions or regulations in force;
 3. Mounting work not carried out by qualified and authorized personnel;
 4. The omission of function tests.
- Please contact customer service for the cases listed below, before proceeding with the installation (see section SUPPORT):
 - a) Nuclear power stations, trains, airplanes, motorcars, incinerators, medical appliances or any other applications where the safety of two or more persons depends on correct device operation;
 - b) Applications not contemplated in these operating instructions.
- Permanent application of maximum locking force F_{Zh} is not permitted.

7 MARKING

The outside of the device is provided with external marking positioned in a visible place. Marking includes:

- Producer trademark
- Part no.
- Batch number and production date. Example: A18 NS1-123456. The batch's first letter refers to the month of manufacture (A=January, B=February, etc.). The second and third digits indicate the production year (18 =2018, 19=2019, etc.).

8 TECHNICAL DATA

8.1 Housing

Metal housing, with powder coating.

Three M20x1.5 threaded cable inlets

Degree of protection: IP67 acc. to EN 60529, IP69K acc. to ISO 20653

Degree of protection for switch with integrated command devices: IP65 acc. to EN 60529

The degree of protection indicated above is ensured only by using a cable gland (or other equivalent connection system) with the same or higher degree of protection

8.2 General specifications

Locking with guard interlocking, contact-free, coded:

Coding level acc. to EN ISO 14119:

Type 4 according to EN ISO 14119
Low level with AC-L300-SCA actuator
High with AC-L300-UCA actuator

		SIL	PL	Cat.	PFH _D	MTTF _D
Mode 1 / Mode 2	Interlock monitoring function (protective device closed)	3	e	4	1.15E-09	3946
	Locking function (protective device locked) - Not available in mode 2	3	e	4	1.15E-09	2968
	Monitoring of the protective device locking function	3	e	4	1.51E-10	4011
	System (general)	3	e	4	1.17E-09	2725
Mode 3	Interlock monitoring function (protective device closed)	2	d	2	1.48E-09	3927
	Locking function (protective device locked)	2	d	2	1.48E-09	2957
	Monitoring of the protective device locking function	3	e	4	1.51E-10	4011
	System (general)	2	d	2	1.84E-09	2511

Note: The SIL, PL and Category values indicated are those that can be achieved by the device. The final values also always depend on the external circuit and wiring.

DC: High
Mission time: 20 years
Ambient temperature: -20°C ... +50°C
Storage temperature: -40°C ... +75°C
Maximum operation altitude: 2000 m
Time for starting the switching operation: 2 s
Maximum actuation frequency with actuator lock and release: 600 switching cycles/hours
Mechanical life expectancy: 1 million switching cycles
Max. actuation speed: 0.5 m/s
Min. actuation speed: 1 mm/s
Installation position: Any
Max. force before breakage F_{1max}: 9750 N according to EN ISO 14119
Max. locking force F_{Zh}: 7500 N according to EN ISO 14119
Play of locked actuator: 4 mm
Extraction force of unlocked actuator: ~ 30 N

8.3 Electrical data of power supply

Nominal operating voltage U_e: 24 VDC ±10% SELV
Operating current at U_e voltage:
- minimum: 40 mA
- with electromagnet activated: 0.4 A
- with electromagnet activated and all outputs at maximum power: 1.2 A
Rated insulation voltage U: 32 VDC
Rated surge withstand voltage U_{imp}: 1.5 kV
External safeguarding: 2 A type gG or equivalent safeguarding
Overvoltage category: III

Electromagnet switch-on time: 100% ED
Electromagnet power consumption: 9 W
Degree of contamination: 3 according to EN 60947-1

8.3.1 Electrical data of IS1/IS2/I3/I4/I5/IE1/IE2/EDM inputs

Nominal operating voltage U_{e1}: 24 VDC
Rated current consumption I_{e1}: 5 mA

8.3.2 Electrical data of OS1/OS2 safety outputs

Nominal operating voltage U_{e2}: 24 VDC
Output type: OSSD, PNP
Maximum current for output I_{e2}: 0.25 A
Minimum current for output I_{m2}: 0.5 mA
Therm. nominal current I_{th2}: 0.25 A
Usage category: DC-13; U_{e2}=24 VDC, I_{e2}=0.25 A
Short-circuit detection: Yes
Overcurrent protection: Yes
Internal self-resetting protection fuse: 1.1 A
Time for deactivation pulses on safety outputs: < 300 μs
Maximum permissible capacitance between outputs: < 200 nF
Maximum permissible capacitance between output and ground: < 200 nF
Response time for OS1 and OS2 safety outputs on input deactivation: Typically 7 ms, max. 15 ms
Response time on door release: Typically 7 ms, max. 12 ms
Maximum delay for EDM input signal state change: 500 ms

8.3.3 Electrical data of O3/O4 signal outputs

Nominal operating voltage U_{e3}: 24 VDC
Output type: PNP
Maximum current for output I_{e3}: 0.1 A
Usage category: DC-13; U_{e3}=24 VDC, I_{e3}=0.1 A
Short-circuit detection: No
Overvoltage protection: Yes
Internal self-resetting protection fuse: 1.1 A

8.3.4 RFID sensor data

Assured operating distance S_{ao}: 2 mm
Assured cut-out distance S_{ar}: 4 mm (actuator not locked)
10 mm (actuator locked)
Nominal switching distance S_n: 2.5 mm
Repeatability: ≤10% S_n
Differential travel: ≤20 % S_n
Maximum switching frequency: 1 Hz
Response time of safety outputs to actuator extraction: Typically 120 ms, max. 200 ms
Min. distance between two identical devices to avoid reciprocal radio interferences: 2 mm

8.4 Technical data of the integrated command devices

8.4.1 General specifications

Degree of protection: IP65 acc. to EN 60529
Mechanical life time: 1 million switching cycles
Spring-return button: 50,000 switching cycles
E-Stop button: 300,000 switching cycles
Selector switch: 50,000 switching cycles
Key selector switch: 30,000 switching cycles including removal of the key

8.4.2 Actuation force

Spring-return button: Min. 4 N max. 100 N
E-Stop button: Min. 20 N max. 100 N
Selector switch: Min. 0.1 Nm max. 1.5 Nm
Key selector switch: Min. 0.1 Nm max. 1.3 Nm

8.4.3 Contact block

Contact material: Silver contacts
Contact type: Self-cleaning contacts
With double interruption

8.4.4 Electrical data

Therm. nominal current (I_{th}): 1 A
Rated insulation voltage (Ui): 32 VAC/DC
Rated surge withstand voltage (U_{imp}): 1.5 kV
LED supply voltage: 24 VDC ± 15%
LED power consumption: 10 mA per LED

8.4.5 Usage category of contact block

Direct current: DC-13 U_e = 24 V, I_e = 0.55 A

8.5 Conformity with standards

EN ISO 14119, EN 60947-5-3:2013, EN 60947-1, EN 60204-1, EN ISO 12100, EN 60529, EN 61000-6-2, EN 61000-6-3, BG-GS-ET-19, IEC 61508:2010, SN 29500, EN ISO 13849-1:2015, EN ISO 13849-2:2012, EN 620614:2005 + EC:2010 + A1:2013 + A2:2015, EN 61326-1, EN 61326-3-1, EN 61326-3-2, ETSI 301 489-1, ETSI 301 489-3, ETSI 300 330-2, UL 508, CSA 22.2 No.14
IEC 60947-5-1, IEC 60947-5-5, EN ISO 13850

8.6 Conformity with directives

Machinery Directive 2006/42/EC, EMC Directive 2014/30/EU, Radio Equipment Directive 2014/53/EU, RoHS Directive 2011/65/EU

Statements acc. to FCC Part 15: This device complies with part 15 of the FCC Rules. Operation is subject to the following two conditions: (1) This device may not cause harmful interference, and (2) this device must accept any interference received, including interference that may cause undesired operation.

9 SPECIAL VERSIONS ON REQUEST

Special versions of the device are available on request.

The special versions may differ substantially from the descriptions in these operating instructions.

The installer must ensure that he has received written information from the support service regarding installation and use of the special version requested.

10 DISPOSAL

At the end of its mission time, the device must be disposed of properly, according to the rules in force in the country in which the disposal takes place.

11 SUPPORT

The device can be used for personnel protection. For questions or doubts concerning installation or use, always contact our technical customer service under the following contact address:

24-hour on-call service at: +49 7021 573-0

Service hotline: +49 7021 573-123

E-mail: service.protect@leuze.de

Return address for repairs:

Service center

Leuze electronic GmbH + Co. KG

In der Braike 1

D-73277 Owen / Germany

12 EC DECLARATION OF CONFORMITY

Leuze electronic GmbH + Co. KG

In der Braike 1, D-73277 Owen/Germany

The safety sensors of the L300 series have been developed and manufactured in accordance with the applicable European standards and directives.

The manufacturer of the product, Leuze electronic GmbH + Co. KG in D-73277 Owen, possesses a certified quality assurance system in accordance with ISO 9001.

© 2019 Copyright Leuze electronic. All rights reserved.