

## Technical data sheet Safety locking device

Part no.: 50142132

L250-P42ML-M12S12-UCA



Figure can vary

### Contents

- Technical data
- Dimensioned drawings
- Electrical connection
- Notes
- Accessories



## Technical data

### Basic data

Series	L250
--------	------

### Functions

Functions	Locking device with guard interlocking in acc. with EN ISO 14119 (type 4)
Activation mode of safety outputs	Safety outputs active if safety door is closed
Operating principle	Open circuit current principle – Actuator locked if electromagnet is activated

### Characteristic parameters

SIL	3, IEC 61508
SILCL	3, IEC/EN 62061
Performance Level (PL)	Up to and including e, EN ISO 13849-1
MTTF <sub>d</sub>	1,671 years, EN ISO 13849-1
PFH <sub>d</sub>	1,24E-09 per hour
Mission time T <sub>M</sub>	20 years, EN ISO 13849-1
Category	4, EN ISO 13849
DC	High
Encoding level	High, EN ISO 14119

### Electrical data

Type of wiring	Series connection Single connection
External safeguarding for supply circuit	2A type Gg (or equivalent)

#### Performance data

Supply voltage U <sub>B</sub>	24 V, DC, -10 ... 10 %
Current consumption, max.	1,200 mA

#### Inputs

Number of safety-related switching inputs	2 Piece(s)
Number of digital switching inputs	3 Piece(s)

#### Switching inputs

Type	Digital switching input
Switching voltage, typ.	24 V
Voltage type	DC
Current consumption, typ.	5 mA

#### Digital switching input 1

Function	IE1 activation input: electromagnet
----------	-------------------------------------

#### Digital switching input 2

Function	IE2 activation input: electromagnet
----------	-------------------------------------

#### Digital switching input 3

Function	I3 programming input / control input for reset
----------	--

#### Safety-related switching inputs

Type	Safety switching input
Voltage type	DC
Switching voltage, typ.	24 V
Current consumption, typ.	5 mA

#### Outputs

Number of safety-related switching outputs (OSSDs)	2 Piece(s)
Number of digital switching outputs	2 Piece(s)

### Safety-related switching outputs

Type	Safety-related switching output OSSD
Voltage type	DC

#### Safety-related switching output 1

Switching element	Transistor, PNP
-------------------	-----------------

#### Safety-related switching output 2

Switching element	Transistor, PNP
-------------------	-----------------

### Switching outputs

Type	Digital switching output
Switching voltage, typ.	24 V
Voltage type	DC

#### Switching output 1

Switching element	Transistor, PNP
Function	O3 signal output: protective-device closed

#### Switching output 2

Switching element	Transistor, PNP
Function	O4 signal output: protective-device locked

### Connection

Number of connections	1 Piece(s)
-----------------------	------------

#### Connection 1

Function	Connection with PLC Contact connection Voltage supply
Type of connection	Connector
Thread size	M12
Type	Male
Material	Metal
No. of pins	12 -pin
Encoding	A-coded

### Mechanical data

Design	Cubic
Dimension (W x H x L)	40 mm x 191.2 mm x 40 mm
Housing material	Plastic
Net weight	500 g
Housing color	Gray
Type of fastening	Through-hole mounting
Side of cable entry	Lateral
Approach speed	0.001 ... 0.5 m/s
Locking force, max.	2,100 N
Mechanical life time	1,000,000 actuation cycles, IEC 60947-5-1 switching cycles
Actuation frequency, max.	600 per hour, IEC 60947-5-1
Extraction force, unlocked actuator	20 N

### RFID sensor data

Assured operating distance S <sub>ao</sub>	2 mm
Assured cut-out distance S <sub>ar</sub>	10 mm (actuator locked) 6 mm (actuator not locked)
Nominal switching distance S <sub>n</sub>	3 mm
Repeatability	≤ 10 % S <sub>n</sub>
Differential travel	≤ 20 % S <sub>n</sub>
Max. switching frequency	1 Hz

## Technical data

### Operation and display

Type of display	LED
Number of LEDs	5 Piece(s)

### Environmental data

Ambient temperature, operation	-20 ... 50 °C
Ambient temperature, storage	-40 ... 75 °C

### Certifications

Degree of protection	IP 67
	IP 69K
Certifications	c UL US
	ECOLAB
	TÜV Süd

### Classification

eCl@ss 5.1.4	27272603
eCl@ss 8.0	27272603
eCl@ss 9.0	27272603
eCl@ss 10.0	27272603
eCl@ss 11.0	27272603
ETIM 5.0	EC002593
ETIM 6.0	EC002593
ETIM 7.0	EC002593

## Dimensioned drawings

All dimensions in millimeters

### Safety locking device

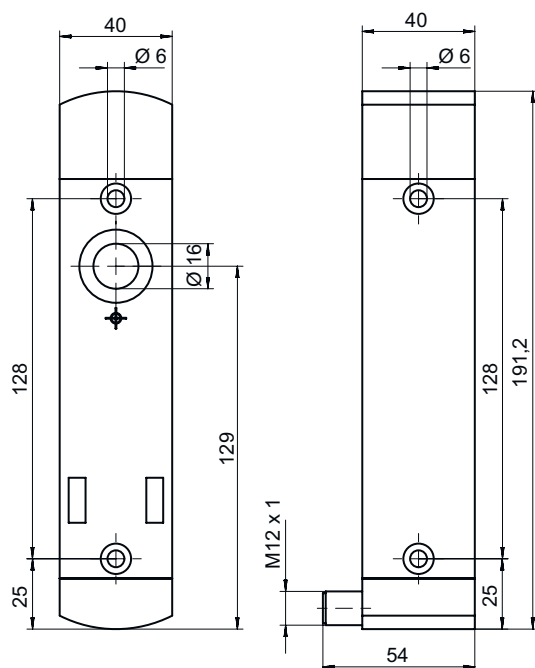

## Dimensioned drawings

### Actuator

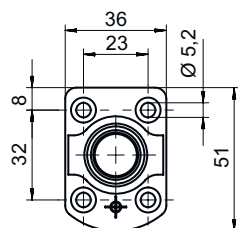
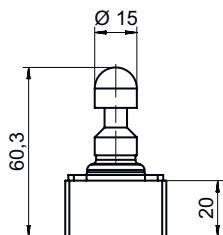

## Electrical connection

### Connection 1

<b>Function</b>	Connection with PLC Contact connection Voltage supply
<b>Type of connection</b>	Connector
<b>Thread size</b>	M12
<b>Type</b>	Male
<b>Material</b>	Metal
<b>No. of pins</b>	12 -pin
<b>Encoding</b>	A-coded

Pin	Pin assignment	Conductor color
1	A1 +24 V	Brown
2	IS1 safe input	Blue
3	A2 +0 V	White
4	OS1 safe output	Green
5	O3 signal output: protective-device closed	Pink
6	IS2 safe input	Yellow
7	OS2 safe output	Black
8	I3 programming input / control input for reset	Gray
9	O4 signal output: protective-device locked	Red
10	IE1 activation input: electromagnet	Violet
11	n.c.	Gray
		Pink
12	IE2 activation input: electromagnet	Blue
		Red

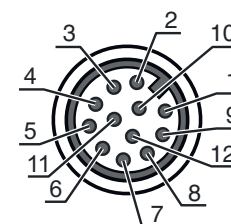

## Notes





### NOTE



The wire color specifications refer to the connection cables listed in the accessories.

## Accessories

### Connection technology - Connection cables

	Part no.	Designation	Article	Description
	50130281	KD S-M12-CA-P1-020	Connection cable	Connection 1: Connector, M12, Axial, Female, A-coded, 12 -pin Connection 2: Open end Shielded: Yes Cable length: 2,000 mm Sheathing material: PUR
	50130282	KD S-M12-CA-P1-050	Connection cable	Connection 1: Connector, M12, Axial, Female, A-coded, 12 -pin Connection 2: Open end Shielded: Yes Cable length: 5,000 mm Sheathing material: PUR
	50139769	KD U-M12-CA-P1-020	Connection cable	Connection 1: Connector, M12, Axial, Female, A-coded, 12 -pin Connection 2: Open end Shielded: No Cable length: 2,000 mm Sheathing material: PUR
	50139770	KD U-M12-CA-P1-050	Connection cable	Connection 1: Connector, M12, Axial, Female, A-coded, 12 -pin Connection 2: Open end Shielded: No Cable length: 5,000 mm Sheathing material: PUR

## Actuator

	Part no.	Designation	Article	Description
	50142133 **	AC-L250-UCA	Actuator	Code type: Unique code Encoding level: High, EN ISO 14119 Dimensions: 40 mm x 48.1 mm x 59.4 mm Housing material: Plastic Housing color: Black Type of fastening: Through-hole mounting

\*\* Included in delivery contents

## Accessories

### Note



↪ A list with all available accessories can be found on the Leuze website in the Download tab of the article detailed page.