



ODS 10 Laser distance sensor



© 2016

Leuze electronic GmbH & Co. KG

In der Braike 1

D-73277 Owen / Germany

Phone: +49 7021 573-0

Fax: +49 7021 573-199

<http://www.leuze.com>

info@leuze.de

1	About this document	6
1.1	Used symbols and signal words	6
1.2	Important terms.....	7
2	Safety	8
2.1	Intended use	8
2.2	Foreseeable misuse	8
2.3	Competent persons	9
2.4	Disclaimer	9
2.5	Laser safety notices.....	9
3	Device description	10
3.1	Device overview.....	10
3.1.1	General information	10
3.1.2	Operating principle	11
3.1.3	Performance characteristics.....	11
3.1.4	Accessories	11
3.2	Connection technology	12
3.3	Indicators and operational controls.....	12
3.3.1	LED indicators	12
3.3.2	Control buttons	12
3.3.3	Display.....	13
3.3.4	Meaning of the display icons.....	15
3.4	Configuration / menu structure	15
3.4.1	Input menu	16
3.4.2	Output Q1 menu.....	16
3.4.3	Output Q2 menu.....	16
3.4.4	Analog Output menu	17
3.4.5	Application menu.....	18
3.4.6	Settings menu	21
3.4.7	Ending configuration.....	21
3.5	Configuration example.....	22
4	Function and applications	25
4.1	Push-through protection	25
4.2	Collision protection	26
4.3	Stack height measurement.....	27
4.4	Loop measurement.....	28
5	Mounting.....	29
5.1	Mounting with mounting system	29
5.2	Mounting with M4 fastening screws.....	29
6	Electrical connection.....	30
6.1	Overview.....	30
6.2	Pin assignment	30



7	Starting up the device	33
7.1	Setting the analog output.....	33
7.1.1	Configuring the analog output	33
7.1.2	Teaching the analog output.....	34
7.2	Setting the switching outputs	35
7.2.1	Configuring switching outputs	35
7.2.2	Teaching the switching outputs	37
7.3	Setting measure mode.....	38
7.4	Reset to factory settings	39
7.5	IO-Link interface	39
7.5.1	Overview	39
7.5.2	IO-Link process data	39
8	Connecting to a PC – Sensor Studio	41
8.1	System requirements	42
8.2	Installing Sensor Studio configuration software and IO-Link USB master	42
8.2.1	Downloading configuration software	42
8.2.2	Installing the Sensor Studio FDT frame	43
8.2.3	Installing drivers for IO-Link USB master	43
8.2.4	Connecting IO-Link USB master to the PC	43
8.2.5	Connecting IO-Link USB master to the sensor	44
8.2.6	Installing the DTM and IODD	45
8.2.7	Importing device descriptions.....	45
8.3	Starting the Sensor Studio configuration software.....	45
8.4	Short description of the Sensor Studio configuration software	47
8.4.1	FDT frame menu	47
8.4.2	IDENTIFICATION function	48
8.4.3	CONFIGURATION function.....	48
8.4.4	PROCESS function	50
8.4.5	DIAGNOSIS function.....	52
8.4.6	Exiting Sensor Studio	53
9	Troubleshooting.....	54
9.1	What to do in case of failure?	54
9.2	LED indicators	54
9.3	Indicators in the display	55
10	Care, maintenance and disposal	56
10.1	Cleaning.....	56
10.2	Servicing	56
10.3	Disposing	56
11	Service and support	57
11.1	What to do should servicing be required?	57
12	Technical data	58
12.1	Measurement data.....	58
12.2	Optical data.....	61
12.3	Indicators and operational controls.....	61
12.4	Electrical data	62
12.5	Mechanical data.....	62
12.6	Environmental data	62
12.7	Dimensioned drawings	63
12.8	Dimensional drawings: Accessories	64

13	Order guide and accessories.....	65
13.1	Type overview ODS 10.....	65
13.2	Accessories – cables and connectors	66
13.3	Other accessories.....	66
13.3.1	Accessories – PC connection.....	67
14	EC Declaration of Conformity.....	68



1 About this document

1.1 Used symbols and signal words

Tab. 1.1: Warning symbols and signal words

	Symbol indicating dangers to persons
	Symbol indicating dangers from harmful laser radiation
NOTE	Signal word for property damage Indicates dangers that may result in property damage if the measures for danger avoidance are not followed.
CAUTION	Signal word for minor injuries Indicates dangers that may result in minor injury if the measures for danger avoidance are not followed.

Tab. 1.2: Other symbols

	Symbol for tips Text passages with this symbol provide you with further information.
	Symbols for action steps Text passages with this symbol instruct you to perform actions.

Tab. 1.3: Terms and abbreviations

DSUpload	Data Storage Upload Upload to the data memory of the connected IO-Link master
DTM	Device Type Manager Software device manager of the sensor
FDT	Field Device Tool Software frame for management of device managers (DTM)
FE	Functionearth
NEC	National Electric Code
IODD	IO Device Description File with information on process data and device parameters
ODS	Optical Distance Sensor Optical distance sensor
OLED	Organic Light Emitting Diode Organic LED
PELV	Protective Extra Low Voltage Protective extra low voltage with reliable disconnection
TOF	Time-of-Flight Distance measurement procedure using the propagation time of the signal
UL	Underwriters Laboratories

1.2 Important terms

Tab. 1.4: Important terms

Accuracy	Maximum expected deviation of the measurement value between the determined and real distance value within the specified measurement range.
Resolution	Smallest representable change in measurement value, distance and speed.
Warmup time	Time the sensor needs in order to reach the operating temperature. An optimal measurement is only possible after the end of the warmup time. The warmup time is approximately 20 minutes.
Output resolution	The output resolution describes how the measurement values are presented on the display and digital interfaces. The output resolution of the ODS 10 is 1 mm and cannot be changed.
Readiness delay	The delay before start-up indicates the point in time when the first valid measurement can be obtained after switching on.
Light switching Dark switching	The behavior of the switching output if an object is within the taught/configured switching distance. <ul style="list-style-type: none"> • Light switching: switching output active (high) • Dark switching: switching output not active (low)
Response time (Response time)	Also integration time or measurement time. Maximum length of time from the occurrence of an erratic change in distance to the steady state of the measurement value. The response time depends on the set average calculation. Although the average calculation increases the response time, it also improves reproducibility.
Output time (Output time)	Time interval of measurement value updating at the interface.
Data storage IO-Link data storage	Data memory of the connected IO-Link master.
DSUpload	Data Storage Upload. Upload to the data memory of the connected IO-Link master.
Diffuse reflection	Return and/or degree of reflection of the radiated light. In the case of sensors with the time-of-flight measurement principle, the measurement range depends on the reflectance. Observe the specifications regarding diffuse reflection (see chapter 12 "Technical data"). <ul style="list-style-type: none"> • 90 % is white • 6 % is black
Time-of-Flight	Distance measurement procedures that determines the distance of an object via the propagation time of a light pulse emitted by the sensor's transmitter that is reflected by the object and received by the sensor's receiver.
Reproducibility	Also repeatability. Deviation of multiple measurement results relative to each other under identical conditions. Dependent on the measurement distance and the diffuse reflection of the measurement object. The reproducibility can be considered as the measure of measurement value noise and is affected by the configuration of the response time.

2 Safety

This sensor was developed, manufactured and tested in line with the applicable safety standards. It corresponds to the state of the art.

2.1 Intended use

The device is designed as an optoelectronic sensor for the optical, contactless measurement of the distance to objects.

Areas of application

The laser distance sensor is designed for the following areas of application:

- High-bay storage device: push-through protection
- Crane: collision protection
- Stack height measurement
- Loop measurement

 **CAUTION**

	<p>Observe intended use!</p> <ul style="list-style-type: none"> ↳ Only operate the device in accordance with its intended use. The protection of personnel and the device cannot be guaranteed if the device is operated in a manner not complying with its intended use. Leuze electronic GmbH + Co. KG is not liable for damages caused by improper use. ↳ Read these original operating instructions before commissioning the device. Knowledge of the original operating instructions is an element of proper use.
---	---

NOTICE

	<p>Comply with conditions and regulations!</p> <ul style="list-style-type: none"> ↳ Observe the locally applicable legal regulations and the rules of the employer's liability insurance association.
---	---

2.2 Foreseeable misuse

Any use other than that defined under "Intended use" or which goes beyond that use is considered improper use.

In particular, use of the device is not permitted in the following cases:

- in rooms with explosive atmospheres
- in circuits which are relevant to safety
- for medical purposes

NOTICE

	<p>Do not modify or otherwise interfere with the device!</p> <ul style="list-style-type: none"> ↳ Do not carry out modifications or otherwise interfere with the device. The device must not be tampered with and must not be changed in any way. The device must not be opened. There are no user-serviceable parts inside. Repairs must only be performed by Leuze electronic GmbH + Co. KG.
---	--

2.3 Competent persons

Connection, mounting, commissioning and adjustment of the device must only be carried out by competent persons.

Prerequisites for competent persons:

- They have a suitable technical education.
- They are familiar with the rules and regulations for occupational safety and safety at work.
- They are familiar with the original operating instructions of the device.
- They have been instructed by the responsible person on the mounting and operation of the device.

Certified electricians

Electrical work must be carried out by a certified electrician.

Due to their technical training, knowledge and experience as well as their familiarity with relevant standards and regulations, certified electricians are able to perform work on electrical systems and independently detect possible dangers.



In Germany, certified electricians must fulfill the requirements of accident-prevention regulations BGV A3 (e.g. electrician foreman). In other countries, there are respective regulations that must be observed.

2.4 Disclaimer

Leuze electronic GmbH + Co. KG is not liable in the following cases:

- The device is not being used properly.
- Reasonably foreseeable misuse is not taken into account.
- Mounting and electrical connection are not properly performed.
- Changes (e.g., constructional) are made to the device.

2.5 Laser safety notices

 WARNING	
	<p>The device satisfies the requirements of IEC 60825-1:2007 (EN 60825-1:2007) safety regulations for a product of laser class 1 as well as the U.S. 21 CFR 1040.10 regulations with deviations corresponding to "Laser Notice No. 50" from June 24, 2007.</p> <ul style="list-style-type: none"> ↳ Observe the applicable statutory and local laser protection regulations. ↳ The device must not be tampered with and must not be changed in any way. There are no user-serviceable parts inside the device. Repairs must only be performed by Leuze electronic GmbH + Co. KG.

3 Device description

3.1 Device overview

3.1.1 General information

The laser distance sensor is an optical distance sensor that operates according to the time-of-flight measurement procedure.

The sensor consists of the following components:

- Transmitter: laser spot
- Receiver
- White OLED display
- Control panel with membrane keyboard
- Status LEDs
- Connection for connecting to the control: M12 connector or cable outlet with open cable end or M12 connector

The sensor can be configured using display and control buttons.

With the *Sensor Studio* configuration software, the sensors can be configured via the IO-Link interface with a PC and the measurement values visualized. Stored parameter sets can be duplicated in other sensors. The connection is made via the IO-Link USB master, which is available as an accessory.

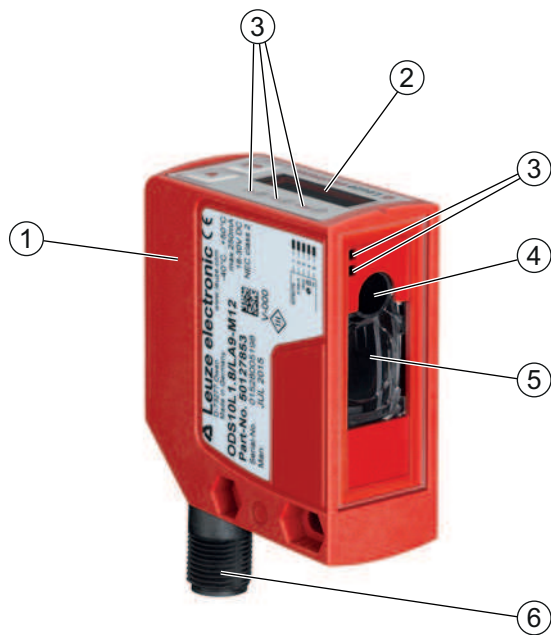

- 1 Device housing
- 2 Display and control panel
- 3 Status LEDs
- 4 Transmitter
- 5 Receiver
- 6 Connection

Fig. 3.1: Device construction

3.1.2 Operating principle

Time-of-flight measurement procedure

The laser distance sensor determines the distance of an object via the propagation time of a light pulse emitted by the sensor's transmitter that is reflected by the object and received by the sensor's receiver. The measurement time is set via the display and control panel or by means of configuration software.

Advantages of the time-of-flight measurement principle:

- Large measurement range
- Low influence of gloss and structures on the measurement value

3.1.3 Performance characteristics

The most important performance characteristic of the ODS 10 laser distance sensor:

- Large measurement range:
 - 50 mm ... 8000 mm against objects (90 % diffuse reflection)
 - 100 mm ... 25000 mm using reflective tape
- Analog current and voltage output (configurable)
Factory setting: current output
- OLED display and membrane keyboard for configuration
- Configurable measurement range and measure mode
- Measurement value display in mm on OLED display
- IO-Link version 1.1
- Optional: multifunction input for deactivating the laser or for teaching the digital switching points (teach-in)
Factory setting: input for deactivating the laser
- Optional: second switching output

For measurement against objects:

- Measurement range: 50 ... 8000 mm
- Measurement against diffusely reflective objects
- Reflection-independent distance information
- Applications:
 - High-bay storage device: push-through protection
 - Crane: collision protection
 - Stack height measurement
 - Loop measurement

For measurement against reflective tape (ODS10L1-25M devices):

- Measurement range: 100 ... 25000 mm
- Applications:
 - Positioning of, e.g., side-tracking skates and cranes

3.1.4 Accessories

Special accessories are available for the laser distance sensor (see chapter 13 "Order guide and accessories"):

- Mounting systems for mounting on rods
- Connection cables
- Reflective tape
- IO-Link USB master set for connecting to a PC

3.2 Connection technology

For the electrical connection of the laser distance sensor, the following connection variants are available:

- M12 connector, 5-pin
- Connection cable, 2000 mm, 5-wire
- Connection cable, 200 mm, with M12 connector, 5-pin

3.3 Indicators and operational controls

The device housing is provided with the following indicators and operational controls:

- OLED display
- Two control buttons
- Green/red LED on the control panel
- Two yellow LEDs:
 - On the control panel
 - On the lens cover

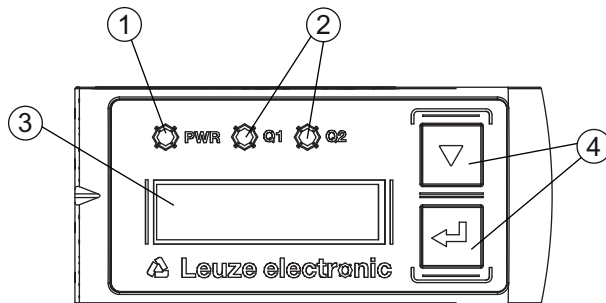

- 1 Green/red LED (PWR)
- 2 Yellow LED (Q1/Q2)
- 3 Display
- 4 Control buttons

Fig. 3.2: Indicators and operational controls

3.3.1 LED indicators

Tab. 3.1: Meaning of the LED indicators on the device housing

LED	Color, state	Description
Green/red LED PWR	Green	Sensor ready
	Orange	Warning, weak signal
	Red	No signal
	Off	No supply voltage
Yellow LED Switching output Q1/Q2	On	Object detected in the switching range
	Off	No object detected in the switching range

3.3.2 Control buttons

The sensor is configured via the display and control buttons. The display is controlled via the control buttons. You can make adjustments in the application via the control buttons.

- ▼ – Scroll through the functions
- ↵ – Enter button: select function, confirm/enter value

The ▼ and ↵ buttons have different functions depending on the operating situation. These functions are displayed via icons at the right edge of the display (see chapter 3.3.4 "Meaning of the display icons").

Navigating within the menus

Use the navigation button ▼ to move through the menu.

Activate the desired selection with the enter button ↵.

The number of bars at the left edge of the display indicates the current menu level.

Selecting options

Set the desired option with the navigation button ▼ and the enter button ↵.

Resetting to factory settings

↵ While switching on the supply voltage, press the enter button ↵ to reset the sensor configuration to the factory settings.

↵ Press the enter button ↵ again to reset all parameters to factory settings. All parameter settings made previously are permanently lost.

Press the navigation button ▼ to return to process mode without resetting the parameters.

NOTICE



You can also use the menu (see chapter 3.4 "Configuration / menu structure") or the *Sensor Studio* configuration software to reset to factory settings (see chapter 8 "Connecting to a PC – Sensor Studio").

3.3.3 Display

The display changes depending on the current operating mode. The following display modes exist:

- Menu display

Press one of the two control buttons once or twice to access the menu display.

For information on operating via the menu, see chapter 3.4 "Configuration / menu structure" and see chapter 3.5 "Configuration example".

- Process mode

After switching on the supply voltage and error-free initialization of the device, the green LED lights up continuously. The laser distance sensor is in process mode.

In process mode, the current measurement value is displayed in the display, e.g. "267 mm".

NOTICE













In the menu display, the selectable or editable values are shown with inverted text colors (black on white background).

If no key is pressed for approx. 6 minutes in the configuration menu, the device automatically returns to the process mode.

The sensor can be protected against unauthorized configuration change by activating the password query (see chapter 3.4.6 "Settings menu"). The password is permanently set to **165**. In addition, a complete button lock can be activated using the lock function (device access locks, bit 2) (see the table "Status displays on the display").







Status displays in process mode

Tab. 3.2: Status displays on the display

	<p>Object distance in mm</p>
	<p>No measurement value available, e.g. due to a weak or missing reception signal; here due to the laser being switched off</p>
	<p>No object detected or reception signal too weak</p>
	<p>Sensor deactivated, laser switched off</p> <ul style="list-style-type: none"> • Via the input function (see chapter 3.4.1 "Input menu" and see chapter 8.4.3 "CONFIGURATION function") • Via the IO-Link command
	<p>The current measurement value is less than the lower limit value of the analog output distance.</p>
	<p>The current measurement value is greater than the upper limit value of the analog output distance.</p>
	<p>The measurement value has an offset</p>
	<p>Level mode e.g. fill level display: offset with falling gradient (-1)</p>
	<p>Warning: Gradient is falling (-1); however, no offset is defined Values < 0 are represented as 0</p>
	<p>Lock function: Button lock activated via IO-Link (device access locks, bit 2) The button lock can also be enabled and set using the configuration software <i>Sensor Studio</i>: Configuration > Local operation</p>



3.3.4 Meaning of the display icons

The ▼ and ↵ buttons have different functions depending on the operating situation. These functions are displayed via icons at the right edge of the display.

Icon	Position	Function
	First line	By pressing the navigation button ▼ you select the next parameter within a menu level.
	Second line	Symbolizes the respective, next menu level that you have not yet selected.
	Second line	Press the enter button ↵ to exit the menu level or the menu.
	Second line	Symbolizes the input mode. The selected (highlighted) option field can be a fixed selection parameter or a multi-digit input field. With a multi-digit input field, you can change the active digit cyclically using the navigation button ▼ and switch from one digit to the next using the enter button ↵.
	Second line	Confirmation of the selection. This icon appears when you complete an option field with the enter button ↵ and the previously entered value is valid. Pressing the enter button ↵ again saves and displays the change locally.
	Second line	Reject the selection. This icon is accessed from the previous icon (check mark) by pressing the navigation button ▼. Press the enter button ↵ to reject the current value or option parameter.
	Second line	Return to selection. This icon is accessed from the previous icon (cross) by pressing the navigation button ▼. This icon is also accessed if the value newly entered previously is outside the permissible value range, making correction of the entry necessary. Press the enter button ↵ to reset the current value or option parameter and enter a new value or select a new option parameter.

3.4 Configuration / menu structure

The following chapters show the structure of all menu items. For each sensor model, only the actually available menu items are present for entering values or for selecting settings.

NOTICE	
	Use the navigation button ▼ to move through the menu. Activate the desired selection with the enter button ↵.
NOTICE	
	The number of bars at the left edge of the display indicates the current menu level. For information on the meaning of the display icons, see chapter 3.3.4 "Meaning of the display icons".

3.4.1 Input menu

The function of the switching input on pin 5 is set in the **Input** menu.

NOTICE				
 The Input menu is only available for sensors with switching input.				
Level 1	Level 2	Level 3	Description	Default
Input	Input Mode		Function of the switching input on pin 5 if the supply voltage is applied.	
		No Function	No input function active	
		Teach	Teach analog output and switching output	
		Deactivation	Switch off laser transmitter with +24 V on the switching input	X
		Activation	Switch on laser transmitter with +24 V on the switching input	
Important: Activation or deactivation using IO-Link commands only has an effect if neither <i>Deactivation</i> nor <i>Activation</i> is set as the input function.				

3.4.2 Output Q1 menu

The switching behavior of switching output Q1 on pin 4 is set in the **Output Q1** menu.

Level 1	Level 2	Level 3	Description	Default
Output Q1	Q1 Upper Sw. Pt.		Upper switching point	ODS10L1.8...: 4000 mm ODS10L1-25.8...: 12500 mm
	Q1 Lower Sw. Pt.		Lower switching point	50 mm
	Notice: For the limit values of the measurement range for your sensor, see chapter 12 "Technical data".			
	Q1 Hysteresis		Hysteresis	ODS10L1.8...: 10 mm ODS10L1-25.8...: 30 mm
	Q1 Light/Dark		Behavior of the switching output if an object is within the taught/configured switching distance. <ul style="list-style-type: none"> • Light switching; switching output active (high) • Dark switching; switching output not active (low) 	Light

3.4.3 Output Q2 menu

- ODS10LA6: The switching behavior of switching output Q2 is set to pin 5 in the **Output Q2** menu.
- ODS10L6X: The switching behavior of switching output Q2 is set to pin 2 in the **Output Q2** menu.

NOTICE	
 The Output Q2 menu is only available for sensors with a second switching output Q2.	

Level 1	Level 2	Level 3	Description	Default
Output Q2	Q2 Upper Sw. Pt.		Upper switching point	ODS10L1.8...: 4000 mm ODS10L1-25.8...: 12500 mm
	Q2 Lower Sw. Pt.		Lower switching point	50 mm
	Notice: For the limit values of the measurement range for your sensor, see chapter 12 "Technical data".			
	Q2 Hysteresis		Hysteresis	ODS10L1.8...: 10 mm ODS10L1-25.8...: 30 mm
	Q2 Light/Dark		Behavior of the switching output if an object is within the taught/configured switching distance. <ul style="list-style-type: none"> • Light switching; switching output active (high) • Dark switching; switching output not active (low) 	Light

3.4.4 Analog Output menu

The characteristic output curve of the analog output is set to pin 2 in the **Analog Output** menu.

NOTICE	
	The Analog Output menu is only available for sensors with analog output.

Level 1	Level 2	Level 3	Description	Default
Analog output	Position Max. Val.		Distance measurement value for maximum voltage / maximum current	Upper limit of the measurement range
	Position Min. Val.		Distance measurement value for minimum voltage / minimum current	50 mm
	Notice: For the limit values of the measurement range for your sensor, see chapter 12 "Technical data".			
	Analog range	4 ... 20 mA 1 ... 10 V 0 ... 10 V	Current/voltage range of the analog output	X

Spreading the characteristic output curve

You can spread the characteristic output curve of the analog output according to your requirements.

- ↪ Select the current or voltage range of the analog output.
- ↪ Set the distance measurement value that corresponds to the lower limit of the measurement range (4 mA, 1 V, 0 V).
- ↪ Set the distance measurement value that corresponds to the upper limit of the measurement range (20 mA, 10 V).

It is also possible to invert the working range of the analog output, i.e., the lower limit of the measurement range is set to a larger value than the upper limit. This creates a descending characteristic output curve.

3.4.5 Application menu

The measurement function of the sensor is set in the **Application** menu.

Level 1	Level 2	Level 3	Description	Default	
Application	Measure mode		Measure mode of the sensor		
		Fast	Shortest response time – for crane positioning		
		Standard	Multi-purpose function for many measurement tasks	X	
		Precision	Greater accuracy for less dynamic applications		
		High precision	Maximum accuracy for non-dynamic applications		
		Individual	Number of measurements	Floating average calculation taking 1 ... 300 measurements into account (response time: 3.4 ms ... 1020 ms) Note: The number of measurements determines the response time in the case of fixed measurement value output (every 3.4 ms).	1
		Outlier suppression	Number of measurements	Blocked central value filtering across buffer sizes from 5 to 300. With 30, updating of the measurement value takes place every 100 ms.	30
Filter depth	Adjustable filter depth: <ul style="list-style-type: none"> • Coarse, averages approx. 75 % of the central measurement values • Medium, averages approx. 50 % of the central measurement values • Fine, averages approx. 25 % of the central measurement values 		Coarse		

Measure modes

The measure mode is set according to the given requirements and the application via the display or using the configuration software *Sensor Studio*.

The measure modes differ with respect to the response times of the sensor. Generally speaking, the higher the response time is, the more precise the measurement result will be.

- A higher response time presupposes the possibility of measuring an object for a longer period.
- The measurement results are output at the interface every 3.4 ms, irrespective of the set measure mode (except in the *Outlier suppression* measure mode).

In the table, you will find an overview of how the choice of measure mode affects the individual parameters of the measurement function.

Tab. 3.3: Measure modes and measurement function parameters

Measure mode	Accuracy	Response time	Output time	Application dynamics
Fast	-	15 ms	3.4 ms	++
Standard	+	50 ms	3.4 ms	+
Precision	++	200 ms	3.4 ms	-
High precision	+++	1000 ms	3.4 ms	--
Individual	Up to +++	Adjustable	3.4 ms	Up to ++
Outlier suppression	Up to +++	Adjustable Default: 100 ms	Adjustable Default: 100 ms	Up to ++

Measure mode Individual

The user can set the sensor response time required for the application:

- The user sets the number of measurements via the display or using the configuration software *Sensor Studio*, e.g. 50 measurements.
- Each measurement takes 3.4 ms.
- Sensor response time:
50 x 3.4 ms = 170 ms

Measure mode Outlier suppression

Measurement results with excessively high or low measurement values (referred to as "outliers" or "spikes") are suppressed or rejected according to the set filter depth.

- The user sets the number of measurements via the display or using the configuration software *Sensor Studio*.
- The sensor performs the set number of measurements on the object, e.g. 100 measurements.

Due to physical reasons, the measurement results are not all the same. The measurement values have a scatter which corresponds to a normal distribution comprising a large number of similar measurement values and a small number of excessively high or low measurement values (outliers, spikes).

The suppression or rejection of the measurement value outliers is configured in the following levels using the filter depth.

- Coarse: A large number of measurement values which do not occur with a high frequency are suppressed or rejected.
 - Falling on one side: 12 %
 - Used center area, averaged: 76 %

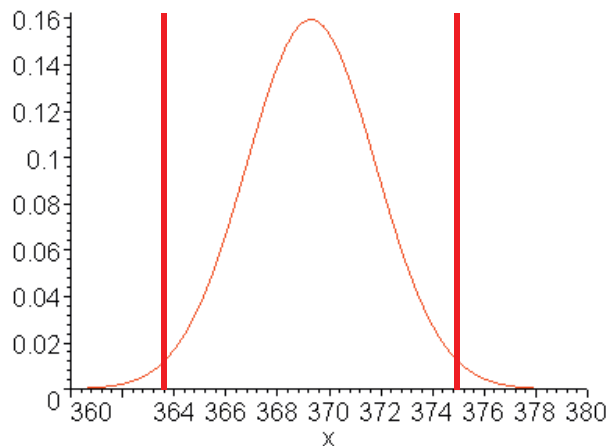

Fig. 3.3: Coarse filter depth

- Medium
 - Falling on one side: 24 %
 - Used center area, averaged: 52 %

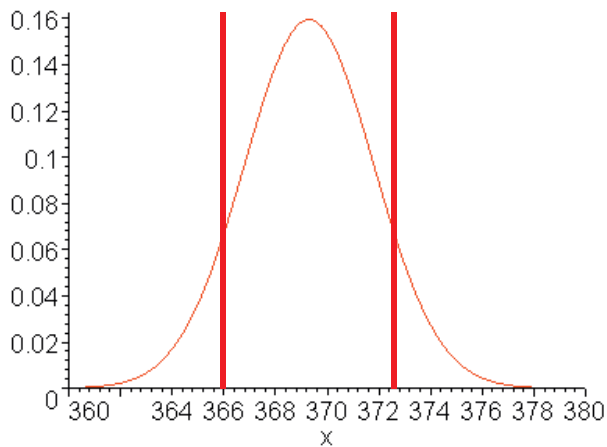

Fig. 3.4: Medium filter depth

- Fine
 - Falling on one side: 36 %
 - Used center area, averaged: 28 %

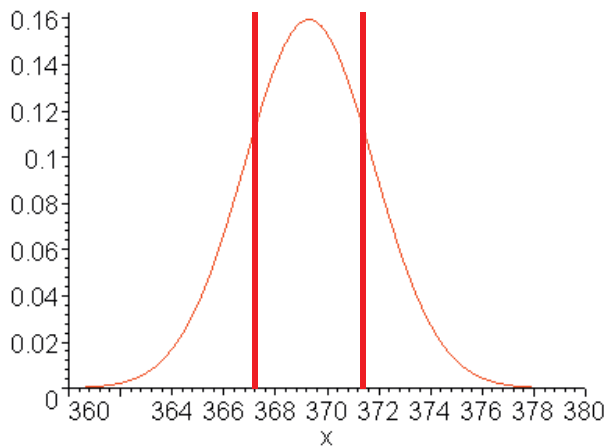

Fig. 3.5: Fine filter depth

NOTICE



In the case of dynamic applications with erratic changes in measurement distance, it is recommended to filter by setting the response time (*Individual* measure mode).

3.4.6 Settings menu

You can set the display language and call up information about the sensor in the **Settings** menu.

Level 1	Level 2	Level 3	Description	Default	
Settings	Language		Setting of the display language Note: If the display language is changed, this change only becomes effective when the sensor is restarted.		
		English	Display language English	X	
		German	Display language German		
	Display		Display settings		
		On	The display (measurement value display) is always at full brightness.		
		Auto	After pressing a control button, the display is set to full brightness for approx. one minute. The display is then dimmed slightly for five minutes and then dimmed considerably.	X	
		Auto off	The display (measurement value display) is automatically switched off after approx. 6 minutes.		
		Off	No measurement value display – the display is only active in the menu after pressing a control button.		
	Factory settings		Reset to factory settings		
		Inactive	The sensor is not reset to factory settings.		
		Execute	The sensor is reset to factory settings.		
	Password Check		Locks access to the menu with the fixed password 165		
		Inactive	Not active	X	
		Activated	Active		
	Info		Information on the sensor		
		Part Number	Leuze part number of the sensor		
		Serial No	Serial number of the sensor		
	Firmware Revision	Firmware version			

3.4.7 Ending configuration

With IO-Link data storage, the configuration settings can be ended in the following ways.

Menu item	Use	Display of the menu item
Exit menu	End	No change and the <i>DSUpload</i> flag is cleared
Exit DSUpId=1	End if the change is to be entered in the data memory. The <i>DSUpload</i> flag is set.	A change has been performed or the <i>DSUpload</i> flag was already set.
Exit DSUpId=0	End if the change is only temporary or no data memory is used. The <i>DSUpload</i> flag is cleared.	A change has been performed or the <i>DSUpload</i> flag was already set.

Central storage of configuration data

If the configuration setting is ended with subsequent adoption of the data in the data memory of a connected IO-Link master, the sensor does not need to be newly configured if a device is changed.

The sensor adopts the configuration from the data memory of the connected IO-Link master, provided that the IO-Link master is capable of doing this and enabled accordingly.

Timeout

If configuration setting is ended due to timeout, the previously made changes are saved locally in a non-volatile memory. The status of the *DSUpload* flag is not changed.



If the *DSUpload* flag is not set, after reconnection the change is overwritten by the configuration which is stored in the data memory of the connected IO-Link master.

NOTICE	
	If the sensor is not operated via an IO-Link master, it is recommended to end the configuration setting using <i>Menu Exit</i> or <i>Exit DSUpId=0</i> .

3.5 Configuration example



To illustrate menu operation, the setting of the lower switching point of switching output Q1 to 100 mm is explained as an example.

↵ In process mode, press a control button to activate the menu display.



Input	
Output Q1	

↵ Press the navigation button ▼.

⇒ The display shows “Output Q1” in the upper menu line.



Output Q1	
Output	

↵ Press the enter button ↵ to select Output Q1.

Q1 Upper Sw. Pt.	
08000 mm	



↵ Press the navigation button ▼ once.

⇒ The display shows “Q1 Lower Sw. Pt.” in the upper menu line.



Q1 Lower Sw. Pt.	
00050 mm	

↵ Press the enter button ↵ to set the lower switching point.



⇒ The first digit of the switching point value is displayed with inverted colors.

Q1 Lower Sw. Pt.	
00050 mm	

↵ Press the enter button ↵ twice until the hundreds digit is inverted.

Q1 Lower Sw. Pt.	
00050 mm	



↵ Press the navigation button ▼ as many times as necessary to set the desired value "1".

Q1 Lower Sw. Pt.	
00150 mm	

↵ Press the enter button ↵ to accept the set value.

↵ Repeat the setting for digit 5 until the complete value "00100" is set.

Press the enter button ↵ to move to the units digit.

Q1 Lower Sw. Pt.	
00100 mm	

After pressing the enter button ↵ again, the  icon appears in the lower right part of the display.



- The  icon indicates that the next time the enter ↵ button is pressed, the set value will be accepted.
- You can change the function of the enter button ↵ by pressing the navigation button ▼ several times. The following icons are displayed in succession:

- : re-edit value
- : reject value



↵ Press the enter button ↵ to accept the set value 00100.

↵ "Q1 Lower Sw. Pt." is displayed inverted in the display.



The newly set value "00100 mm", which is stored in non-volatile memory, appears in the display.

Q1 Lower Sw. Pt.	
00100 mm	



↵ Press the navigation button ▼ repeatedly until the ← icon appears in the upper menu line.

←	
Q1 Upper Sw. Pt.	

↵ Press the enter button ↵ to access the next-higher menu level.

Output Q2	
Analog output	

↵ Press the navigation button ▼ repeatedly until "← Ende DSUpId=1" appears in the upper menu line.

← Exit DSUpId=1	
← Exit DSUpId=0	

↵ Press the enter button ↵ to exit the menu display and access process mode.



Ending configuration setting with "← Exit DSUpd=1" causes the *DSUpload* flag to be set. An IO-Link master which is already connected or which is to be connected in the future adopts the change in its data memory, provided that it has been enabled to do so (see chapter 3.4.7 "Ending configuration").

4 Function and applications

The laser distance sensor is a distance sensor with an extensive range of applications for intralogistic, industrial and packaging applications.

The laser distance sensor can be used for the following areas of application:

- High-bay storage device: push-through protection; see chapter 4.1 "Push-through protection"
- Crane: collision protection; see chapter 4.2 "Collision protection"
- Stack height measurement; see chapter 4.3 "Stack height measurement"
- Loop measurement; see chapter 4.4 "Loop measurement"

4.1 Push-through protection

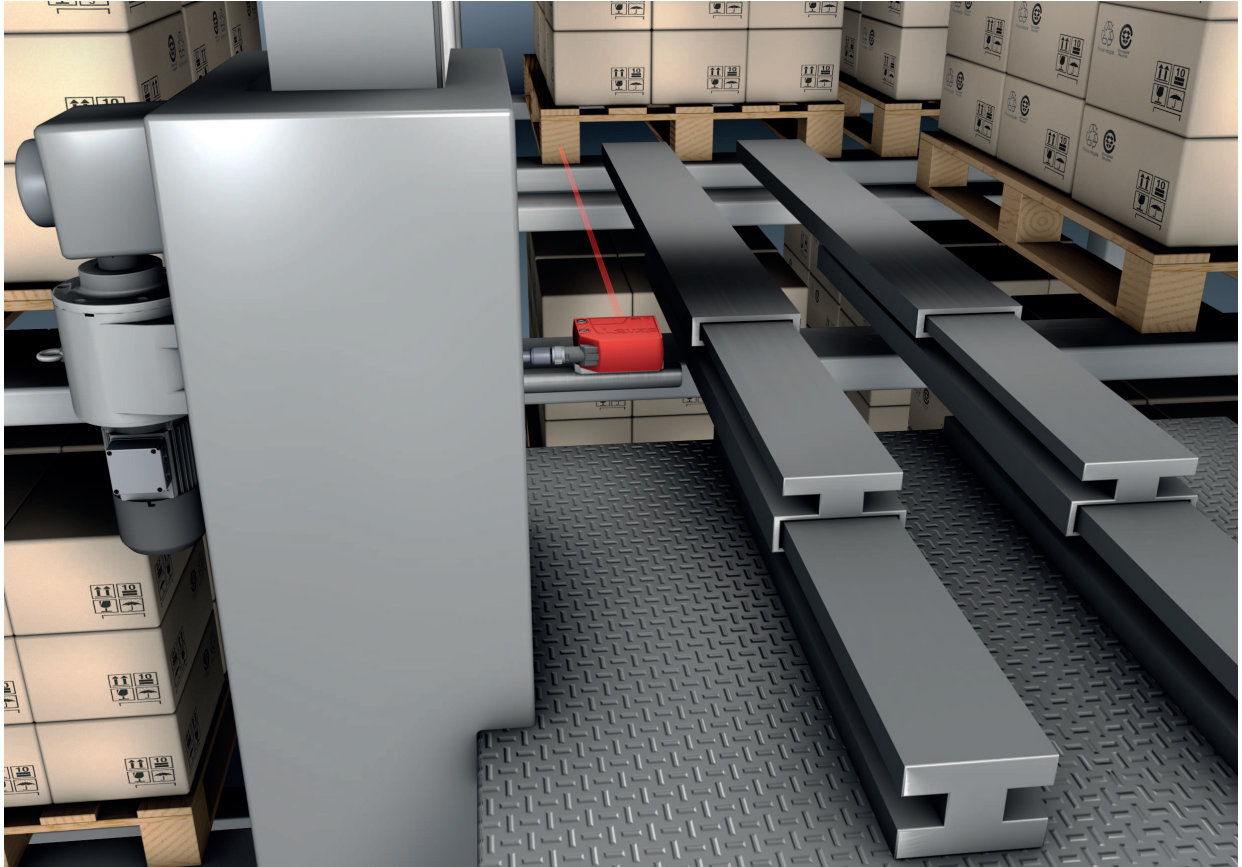

Fig. 4.1: High-bay storage device: push-through protection

4.2 Collision protection

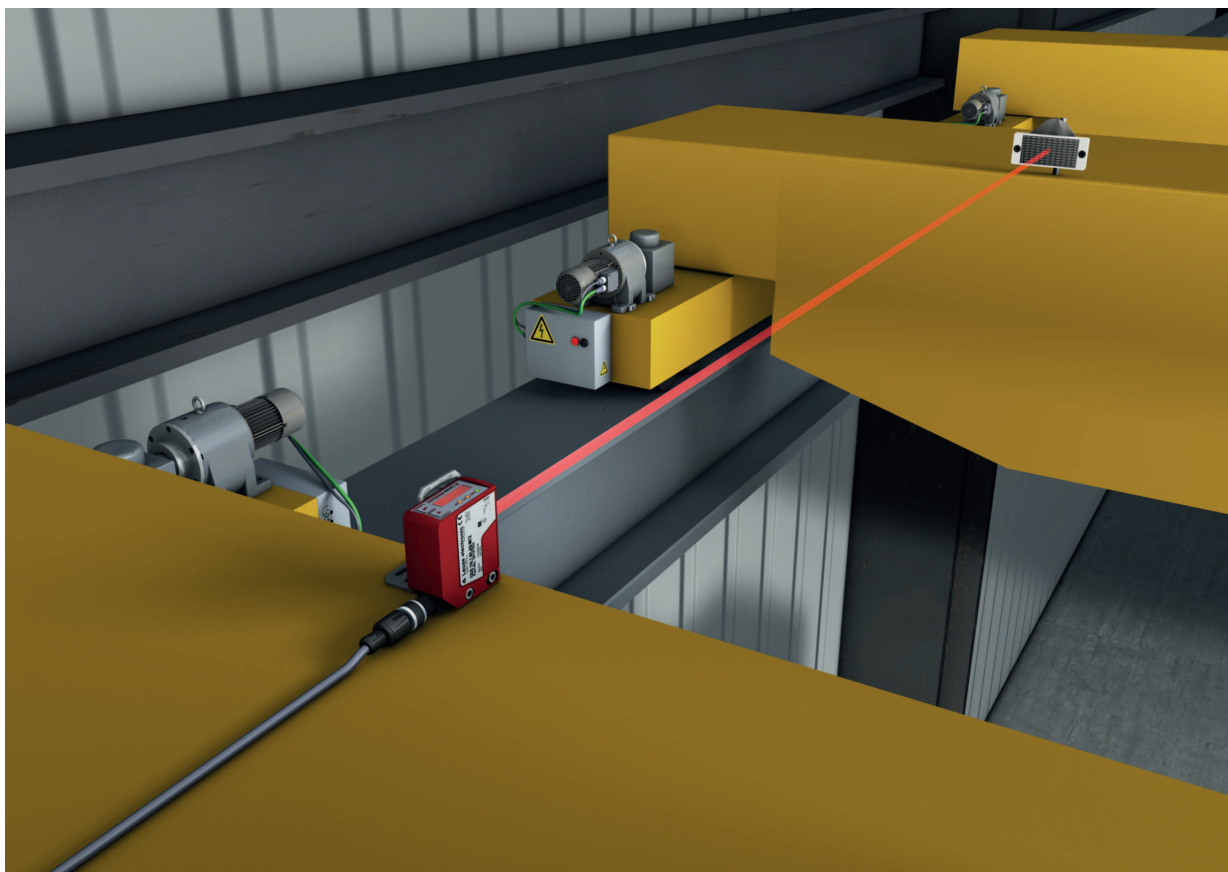

Fig. 4.2: Crane: collision protection

- Measurement against reflective tape (ODS10L1-25M devices), 100 mm ... 25000 mm

4.3 Stack height measurement

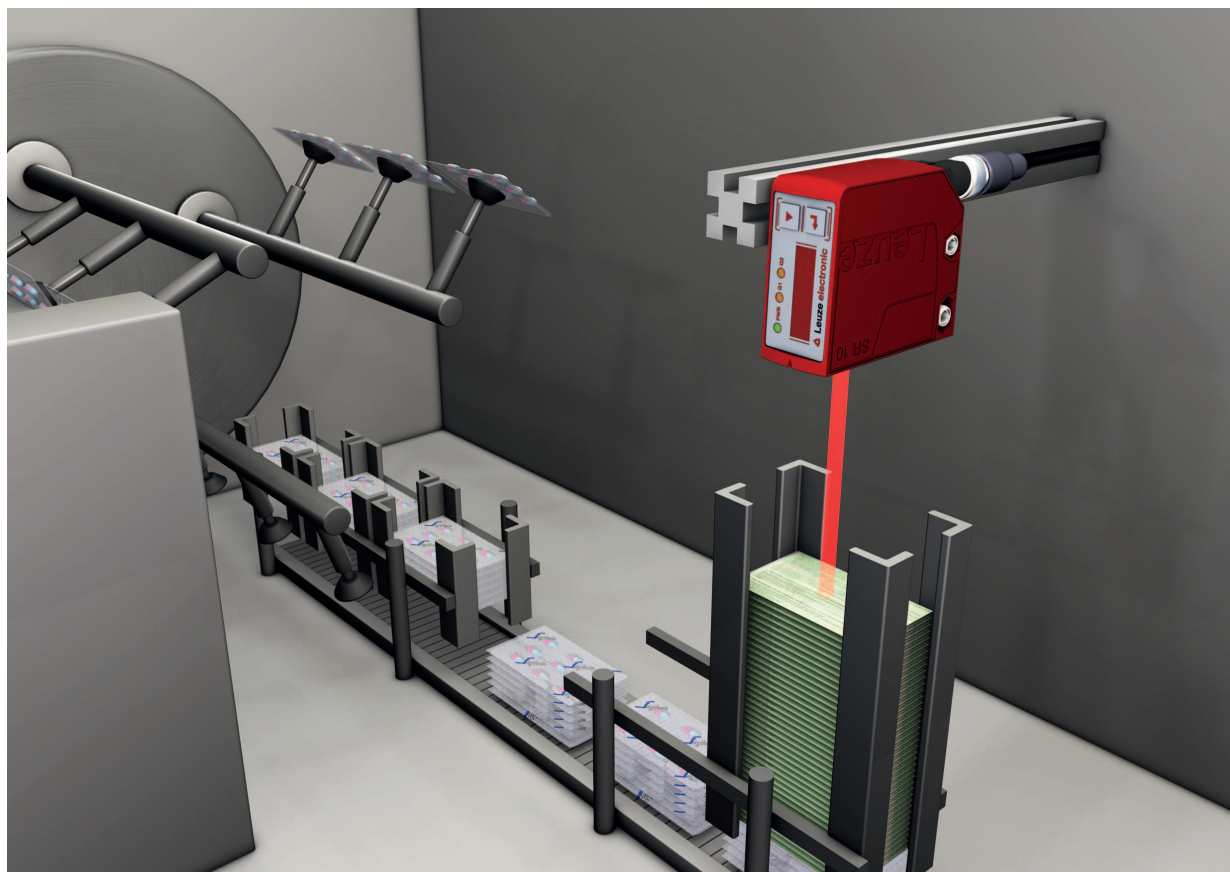

Fig. 4.3: Stack height measurement

4.4 Loop measurement



Fig. 4.4: Loop measurement

5 Mounting

The sensor can be mounted in the following ways:

- Mount using a mounting system
 - BTU 300M-D10: mounting on rod Ø 10 mm
 - BTU 300M-D12: mounting on rod Ø 12 mm
 - BTU 300M-D14: mounting on rod Ø 14 mm
- Mount using inlay nuts in the housing for custom mounting depending on the area of application.

NOTICE



Observe during mounting!

- ↳ Make certain that the required environmental conditions (humidity, temperature) are maintained.
- ↳ Make certain that the optics cover of the sensor is not soiled, e.g., by leaking fluids, abrasion from boxes or residues from packaging material.
- ↳ When mounting behind a cover: Make certain that the cutout in the cover is at least as large as the lens cover of the sensor. Correct measurement cannot otherwise be ensured.

5.1 Mounting with mounting system

Mounting with a mounting system is intended for rod mounting. For ordering information, see chapter 13.3 "Other accessories".

- ↳ Mount the mounting system on the rod (system-side).
- ↳ Mount the sensor on the mounting system with M4 fastening screws (not included in delivery contents).
Max. tightening torque of the fastening screws: 1.4 Nm

5.2 Mounting with M4 fastening screws

- ↳ Mount the sensor on the machine with M4 fastening screws (not included in delivery contents).
Max. tightening torque of the fastening screws: 1.4 Nm

NOTICE











For space-saving installation of the sensor, both sides of the housing are provided with recesses for M4 inlay nuts. Depth of the recesses: 4.2 mm.

6 Electrical connection

6.1 Overview

The assignment of the electrical connections is dependent on the type of sensor that is used. The type designation of the sensor is specified on the name plate.

 CAUTION	
	<p>Safety notices!</p> <ul style="list-style-type: none">  Before connecting the device, be sure that the supply voltage agrees with the value printed on the name plate.  Only allow competent persons to perform the electrical connection.  Ensure that the functional earth (FE) is connected correctly. Fault-free operation is only guaranteed if the functional earth is connected properly.  If faults cannot be rectified, take the sensor out of operation. Protect the sensor from accidentally being started.

NOTICE	
	<p>Protective Extra Low Voltage (PELV)</p> <ul style="list-style-type: none">  The sensor is designed in accordance with safety class III for supply with PELV (protective extra-low voltage).

NOTICE	
	<p>For all connections (connection cable, interconnection cable, etc.), use only the cables listed in the accessories (see chapter 13.2 "Accessories – cables and connectors").</p>

6.2 Pin assignment

Pin assignment for ODS10L1.8/LAK-M12, ODS10L1.8/LAK,200-M12, ODS10L1-25M.8/LAK-M12

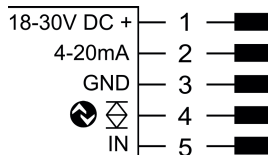



Fig. 6.1: Pin assignment

Pin	Designation	Assignment
1	18-30 V DC +	Supply voltage
2	4-20 mA	Configurable analog output <ul style="list-style-type: none"> • Current: 4 mA ... 20 mA • Voltage: 1 V ... 10 V, 0 V ... 10 V Factory setting: Current
3	GND	Functional earth
4		IO-Link / switching output 1, push-pull
5	IN	Function of the switching input

Pin assignment ODS10L1.8/L6X-M12

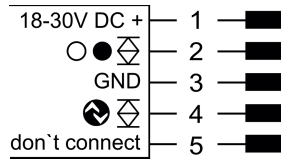

Fig. 6.2: Pin assignment

Pin	Designation	Assignment
1	18-30 V DC +	Supply voltage
2		Switching output 2, push-pull
3	GND	Functional earth
4		IO-Link / switching output 1, push-pull
5	don't connect	don't connect

Pin assignment ODS10L1.8/LAK, ODS10L1-25M.8/LAK

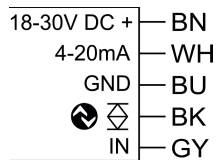

Fig. 6.3: Pin assignment

Pin	Designation	Assignment	Core color
1	18-30 V DC +	Supply voltage	BN, brown
2	4-20 mA	Configurable analog output <ul style="list-style-type: none"> • Current: 4 mA ... 20 mA • Voltage: 1 V ... 10 V, 0 V ... 10 V Factory setting: Current	WH, white
3	GND	Functional earth	BU, blue
4		IO-Link / switching output 1, push-pull	BK, black
5	IN	Function of the switching input	GY, gray

Pin assignment ODS10L1.8/LA6-M12, ODS10L1.8/LA6,200-M12

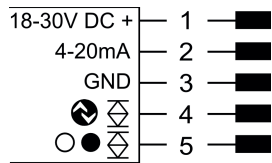

Fig. 6.4: Pin assignment

Pin	Designation	Assignment
1	18-30 V DC +	Supply voltage
2	4-20 mA	Configurable analog output <ul style="list-style-type: none"> • Current: 4 mA ... 20 mA • Voltage: 1 V ... 10 V, 0 V ... 10 V Factory setting: Current
3	GND	Functional earth
4		IO-Link / switching output 1, push-pull
5		Switching output 2, push-pull

7 Starting up the device

7.1 Setting the analog output

7.1.1 Configuring the analog output

The sensors are equipped with an analog output with linear response within the respective measurement range. Above and below the measurement range linearity is not obtained. If a signal is present, the output values can be used to determine whether the measurement range is exceeded or not met.

The analog output is configured using the OLED display and the keyboard (see chapter 3.4 "Configuration / menu structure") or using the *Sensor Studio* configuration software (see chapter 8 "Connecting to a PC – Sensor Studio").

In order to achieve the highest resolution possible, set the range of the analog output as small as the application allows.

The characteristic output curve can be configured as rising or falling, e.g. for fill level applications. For this purpose, both distance values *Position Min. Val.* and *Position Max. Val.* for the minimum and maximum analog output value are set accordingly.

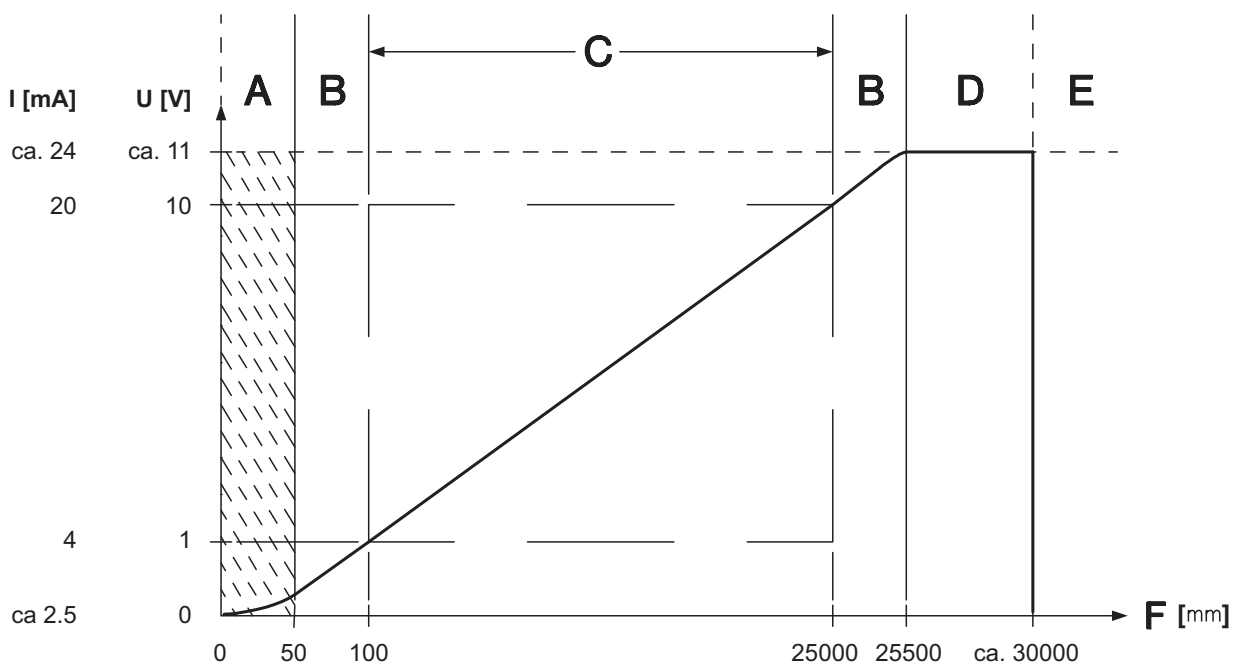

- A Area not defined
- B Linearity not defined
- C Measurement range
- D Object present
- E No object detected
- F Measurement distance

Fig. 7.1: Behavior of analog output ODS10L1-25M.8/L (factory setting)

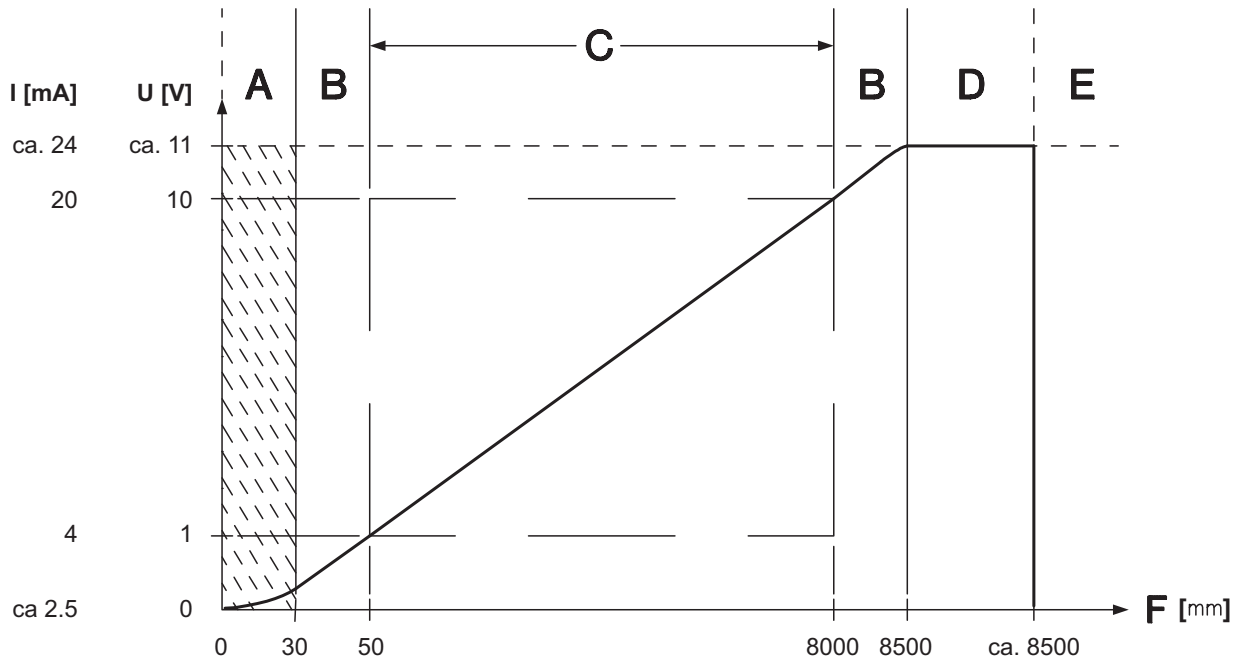

- A Area not defined
- B Linearity not defined
- C Measurement range
- D Object present
- E No object detected
- F Measurement distance

Fig. 7.2: Behavior of analog output ODS10L1.8/L (factory setting)

7.1.2 Teaching the analog output

You can set the characteristic output curve for the analog output as follows:

- via the configuration menu
- via IO-Link
- via the *Sensor Studio* configuration software (see chapter 8 "Connecting to a PC – Sensor Studio")

Alternatively, you can teach the analog output using IO-Link commands or via the switching input (pin 5).

NOTICE	
	The teach-in described below is only possible for sensors with switching input.

- ↳ Activate teaching in the configuration menu via the OLED display and keyboard:
Input > Input Mode > Teach

NOTICE	
	Move through the configuration menu with the navigation button ▼. Activate the desired selection with the enter button ↵.

- ↳ Position the measurement object at the desired distance.

- ↳ Activate the teach input (pin 5) by applying a signal (see figure below).
The width of the low level at the teach input is determined by the teach-in function.

Tab. 7.1: Teach-in function depending on the duration of the teach signal

Teach-in function	Duration of the teach signal (T)
Distance value for the start of the measurement range Corresponds to 1 V or 4 mA on the analog output (pin 5)	120 ms ... 180 ms
Distance value for the end of the measurement range Corresponds to 10 V or 20 mA on the analog output (pin 5)	220 ms ... 280 ms

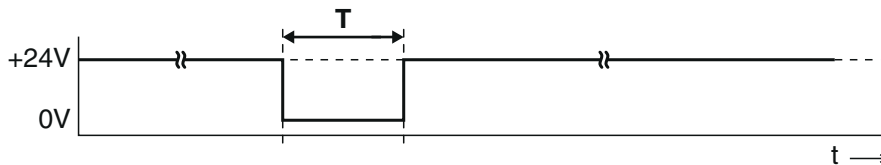

T Duration of the teach signal

Fig. 7.3: Plot of the teach signal

- ↳ Ensure that the teach values are taken over correctly by checking the corresponding entries in the configuration menu.

7.2 Setting the switching outputs

NOTICE



All sensors have a switching output Q1. Sensor models with an additional "6" in the part number code have a second switching output Q2.

7.2.1 Configuring switching outputs

For each switching output you can configure the following parameters:

- Upper and lower switching point
- Hysteresis
- Switching behavior
Light switching or dark switching

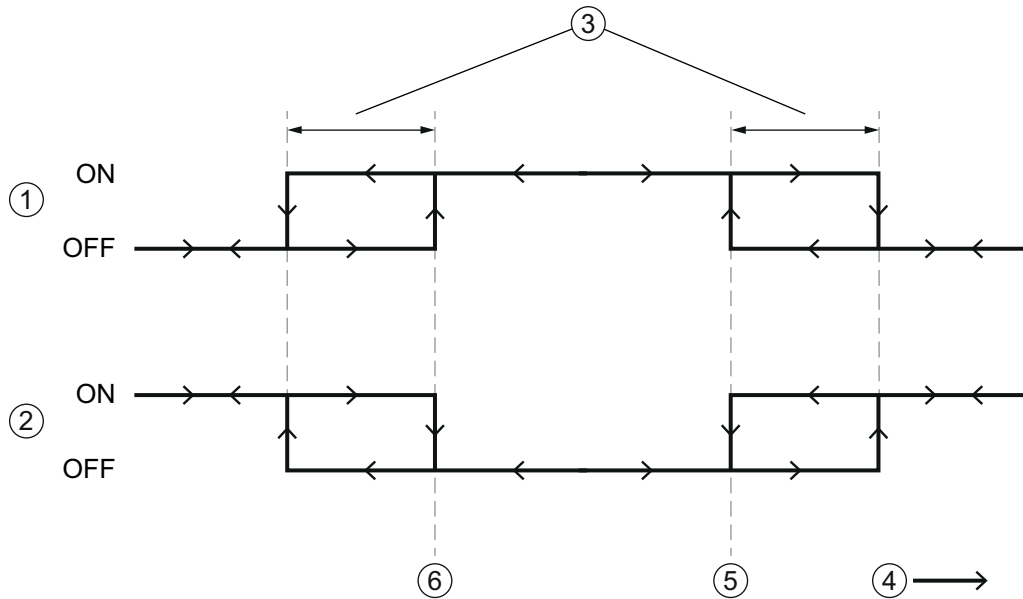

- 1 Light switching
- 2 Dark switching
- 3 Hysteresis
- 4 Measurement distance
- 5 Upper switching point
- 6 Lower switching point

Fig. 7.4: Switching output configuration

Configuration of the switching output(s) is performed using the OLED display and the keyboard (see chapter 3.4 "Configuration / menu structure") or using the IO-Link, for example via the *Sensor Studio* configuration software (see chapter 8 "Connecting to a PC – Sensor Studio").

The following configuration settings are only available via IO-Link or with the configuration software *Sensor Studio*:

- Switching mode (default: *Auto-teach*)
- Window width (only with activated *Window-teach*, where $\neq 0$)
- Analysis depth: to suppress interference, changing of the switching output is delayed by this number of identical measurement results
- System commands for teach actions

With most teach actions, the switching mode is switched over automatically:

- Automatic mode (*Auto-teach*): the teach point depends on the previous position of the switching points (see chapter 7.2.2 "Teaching the switching outputs").
- Window mode (*Window-teach*): a window whose width is determined by the upper and lower switching point or by the window width is stretched symmetrically about the teach point (see chapter 7.2.2 "Teaching the switching outputs").
- Teach-in of the upper and lower switching point: particularly suitable for teaching the window width for the *Window-teach*.

Two button operating modes with the lower switching point at the lower measurement value limit:

- *Object mode*: the teach object only just triggers; switch-off if the distance increases.
- *Background mode*: teach-in relative to the background, i.e. the teach object does not quite trigger; switch-on if the distance decreases.

7.2.2 Teaching the switching outputs

You can set switching points, hysteresis and switching behavior for the switching outputs via the configuration menu.

Alternatively, the switching output can be taught via IO-Link commands (*Sensor Studio* configuration software) or via pin 5.

NOTICE	
	The teach-in described below is only possible for sensors with switching input.

↪ Activate teaching in the configuration menu via the OLED display and keyboard:
Input > Input Mode > Teach

NOTICE	
	Move through the configuration menu with the navigation button ▼. Activate the desired selection with the enter button ↵.

↪ Statically position the measurement object at the desired distance.

↪ Activate the teach input (pin 5) by applying a signal (see chapter 7.1.2 "Teaching the analog output").
The width of the low level at the teach input is determined by the teach-in function.

Tab. 7.2: Teach-in function depending on the duration of the teach signal

Teach-in function	Duration of the teach signal (T)
Auto-teach Q1	20 ms ... 80 ms
Window teach Q1	320 ms ... 380 ms

Teach-in using automatic switching mode (Auto-teach)

Auto-teach offers the following possibilities for teaching the switching range:

The examples describe teaching switching output Q1 for a sensor with a measurement range of 50 mm ... 8000 mm.

- Teach the upper switching point

If the lower switching point is set to the lower limit of the measurement range using the menu or configuration software, the upper switching point is taught.

Switching point *Q1 Lower Sw. Pt.* = 50 mm and switching point *Q1 Upper Sw. Pt.* < 8000 mm, e.g.

- Switching point *Q1 Lower Sw. Pt.* = 50 mm
- Switching point *Q1 Upper Sw. Pt.* = 1200 mm

The teach point defines the upper switching point. If a measurement distance of e.g. 1000 mm is now taught, Q1 switches on at 50 mm and back off at 1000 mm.

- Teach the lower switching point

If the upper switching point is set to the upper limit of the measurement range using the menu or configuration software, the lower switching point is taught.

Switching point *Q1 Upper Sw. Pt.* = 8000 mm and switching point *Q1 Lower Sw. Pt.* > 50 mm, e.g.

- Switching point *Q1 Upper Sw. Pt.* = 8000 mm
- Switching point *Q1 Lower Sw. Pt.* = 1000 mm

The teach point defines the lower switching point. If a measurement distance of e.g. 1000 mm is now taught, Q1 switches on at 1000 mm and back off at 8000 mm.

- Teach window

If both switching points are set to values \neq the lower or upper limit of the measurement range, the difference between the two values defines a switching range.

Switching point *Q1 Lower Sw. Pt.* > 50 mm and switching point *Q1 Upper Sw. Pt.* < 8000 mm, e.g.

- Switching point *Q1 Lower Sw. Pt.* = 1100 mm
- Switching point *Q1 Upper Sw. Pt.* = 1200 mm
- Switching range: 100 mm

The teach point lies in the middle of the switching range. If a measurement distance of e.g. 1000 mm is now taught, the switching output Q1 switches on at 950 mm and back off at 1050 mm.

Teach-in using window mode (Window-teach)

The window mode is an alternative to "Teach window" in the *Auto-teach* mode.

- The switching range is determined by the previous distance between the two switching points, irrespective of the previous position of the switching points. These switching points can be set using IO-Link commands by means of two teach actions, e.g. **Teach-In Q1**, upper switching point and lower switching point.
- If in *Window-teach* mode the parameter *Window width* is set to $\neq 0$, the set window width is used as the switching range.

NOTICE	
	The parameter <i>Window width</i> can only be set via IO-Link and using the configuration software <i>Sensor Studio</i> .

7.3 Setting measure mode

↪ Set the measure mode using the display and the keyboard (Application menu item; see chapter 3.4.5 "Application menu") or using the *Sensor Studio* configuration software (see chapter 8 "Connecting to a PC – Sensor Studio").

- Fast
Short response time for dynamic measurement tasks, e.g. crane positioning
- Standard
Multi-purpose mode (factory setting)
- Precision
Higher accuracy for measurement tasks with extremely low dynamics requirements
- High precision
For static measurements for which high accuracy is required.

In the table, you will find an overview of how the choice of measure mode affects the individual parameters of the measurement function.

Tab. 7.3: Measure modes and measurement function parameters

Measure mode	Accuracy	Response time	Output time	Application dynamics
Fast	-	15 ms	3.4 ms	+ +
Standard	+	50 ms	3.4 ms	+
Precision	+ +	200 ms	3.4 ms	-
High precision	+ + +	1000 ms	3.4 ms	- -

7.4 Reset to factory settings

Configuration is performed using the OLED display and the keyboard (see chapter 3.4 "Configuration / menu structure") or using the *Sensor Studio* configuration software (see chapter 8 "Connecting to a PC – Sensor Studio").

To reset the sensor via the OLED display and keyboard, proceed as follows:

- ↵ Switch off the voltage supply or disconnect the sensor from the voltage supply.
- ↵ Press the enter button ↵ and hold down the button.
- ↵ Switch on the voltage supply or connect the sensor to the voltage supply.
 - ⇒ The LEDs for PWR and switching output Q1/Q2 flash.
- ↵ Press the enter button ↵ again.
- ⇒ The sensor restarts, reset to the factory settings.

7.5 IO-Link interface

7.5.1 Overview

The sensors are equipped with an IO-Link 1.1 interface for configuration and measurement data output.

- The sensor transfers data packets in the TYPE_2_V process data format.
- Eight status bits and 16 measurement value bits are transferred. On the control-side, you can only use the measurement value bits.
- The sensor cyclically transfers (minCycleTime = 3 ms) data packets at a baud rate of 38.4 kBaud (COM2).
- The process data and parameters are described in the IO Device Description (IODD) file.
- ↵ Download the IODD file from the Internet (www.leuze.com).
- ↵ Unpack the ZIP archive to a separate directory. The supplementary HTML files contain a description in tabular form.
- You can configure the sensor using the *Sensor Studio* configuration software (see chapter 8 "Connecting to a PC – Sensor Studio").

7.5.2 IO-Link process data

Process data format: M-sequence TYPE_2_V

- PDOOut (Master -> Sensor): none
- PDIn (Sensor -> Master): 24-bit (16 measurement value bits, 8 status bits)

Measurement values

16-bit measurement value: distance to the object – between lower and upper limit of the measurement range – in mm.

15	14	13	12	11	10	9	8	7	6	5	4	3	2	1	0
----	----	----	----	----	----	---	---	---	---	---	---	---	---	---	---

Special values:

- Signal=0 (no reception signal): 65535
- Measurement range exceeded: upper limit of the measurement range
- Measurement range below minimum value: lower limit of the measurement range
- Measurement=0 (while teaching or during activation): last measurement value or 65535 can be set (behavior upon deactivation)
- Measurement=0 (during start-up): 65535

Status bits

Tab. 7.4: Status bits

Bit	23	22	21	20	19	18	17	16
Value	0	0	W	S	M	Q3	Q2	Q1
0	Unassigned bits (bit 22 and bit 23) are 0; initialization state is also 0							
M	1: running measurement (measurement running) 0: during start-up, teaching, deactivation							
S	1: signal OK, reception signal is sufficient for measurement value output							
W	1: warning; e.g., weak reception signal							
Q1 ... Q3	Switching states Q1, Q2, Q3 1: active							

8 Connecting to a PC – Sensor Studio

The *Sensor Studio* configuration software – in combination with an IO-Link USB master – provides a graphical user interface for the operation, configuration and diagnosis of sensors with IO-Link configuration interface (IO-Link devices), independent of the selected process interface.

Each IO-Link device is described by a corresponding IO Device Description (IODD file). After importing the IODD file into the configuration software, the IO-Link device connected to the IO-Link USB master can be operated, configured and checked – conveniently and in multiple languages. An IO-Link device that is not connected to the PC can be configured offline.

Configurations can be saved and reopened as projects for transferring back to the IO-Link device at a later time.

NOTICE	
	<p>Only use the <i>Sensor Studio</i> configuration software for products manufactured by Leuze electronic.</p> <p>The <i>Sensor Studio</i> configuration software is offered in the following languages: German, English, French, Italian and Spanish.</p> <p>The FDT frame application of the <i>Sensor Studio</i> supports all languages; all languages may not be supported in the IO-Link device DTM (Device Type Manager).</p>

The *Sensor Studio* configuration software is designed according to the FDT/DTM concept:

- You make the individual configuration settings for the sensor in the Device Type Manager (DTM).
- The individual DTM configurations of a project can be called up via the frame application of the Field Device Tool (FDT).
- Communication DTM: IO-Link USB master
- Device DTM: I/O-Link Device/IODD for ODS 10

NOTICE	
	<p>Configuration changes only via the control!</p> <p>↪ Always perform the configuration for process mode via the control and, if applicable, the interface.</p> <p>In process mode, only the configuration conveyed via the control is active. The configuration changes made via <i>Sensor Studio</i> are only active in process mode if they were previously transmitted 1:1 to the control.</p>

Procedure for the installation of the software and hardware:

- ↪ Install the *Sensor Studio* configuration software on the PC.
- ↪ Install the driver for the IO-Link USB master on the PC.
- ↪ Connect the IO-Link USB master to the PC.
- ↪ Connect the OSD 10 (IO-Link device) to the IO-Link USB master.
- ↪ Install IO-Link device DTM with IODD file for ODS 10 in the *Sensor Studio* FDT frame.

8.1 System requirements

To use the *Sensor Studio* configuration software, you need a PC or laptop with the following specifications:

Tab. 8.1: System requirements for Sensor Studio installation

Operating system	Windows 7 Windows 8
Computer	<ul style="list-style-type: none"> • Processor type: 1 GHz or higher • USB interface • CD-ROM drive • Main memory <ul style="list-style-type: none"> • 1 GB RAM (32-bit operating system) • 2 GB RAM (64-bit operating system) • Keyboard and mouse or touchpad
Graphics card	DirectX 9 graphic device with WDDM 1.0 or higher driver
Additionally required capacity for <i>Sensor Studio</i> and IO-Link device DTM	350 MB hard drive memory 64 MB main memory

NOTICE

	Administrator privileges on the PC are necessary for installing <i>Sensor Studio</i> .
--	--

8.2 Installing Sensor Studio configuration software and IO-Link USB master

NOTICE

	<p>The installation files of the <i>Sensor Studio</i> configuration software must be downloaded from the Internet at www.leuze.com.</p> <p>For subsequent updates, you can find the most recent version of the <i>Sensor Studio</i> installation software on the Internet at www.leuze.com.</p>
---	---

8.2.1 Downloading configuration software

- ↪ Call up the Leuze home page: **www.leuze.com**
- ↪ Enter the type designation or part number of the device as the search term.
- ↪ The configuration software can be found on the product page for the device under the *Downloads* tab.

NOTICE

	On delivery, the device is configured for HID operation (Human Interface Device). The device can thereby be operated directly via the Windows application.
---	--

8.2.2 Installing the Sensor Studio FDT frame

NOTICE	
	<p>First install the software!</p> <ul style="list-style-type: none"> ↪ Do not yet connect the IO-Link USB master to the PC. First install the software.

NOTICE	
	<p>If FDT frame software is already installed on your PC, you do not need the <i>Sensor Studio</i> installation.</p> <p>You can install the communication DTM (IO-Link USB master) and the device DTM (IO-Link device ODS 10) in the existing FDT frame.</p>

- ↪ Start your PC with administrator privileges and log on.
- ↪ Download the *Sensor Studio* configuration software from the Internet: www.leuze.com > **Products** > **Measuring sensors** > **Distance sensors** > **Optical distance sensors** > **ODS 10** > **Downloads tab** > **Software/Driver**
- ↪ Copy the file into a suitable folder on your hard drive and unpack the zip file.
- ↪ Start the *SensorStudioSetup.exe* file and follow the instructions on the screen.
- ⇒ The installation wizard installs the software and places a shortcut on the desktop ().

8.2.3 Installing drivers for IO-Link USB master

- ↪ Select the **IO-Link USB Master** installation option and follow the instruction on the screen.
- ⇒ The installation wizard installs the software and places a shortcut on the desktop ().

8.2.4 Connecting IO-Link USB master to the PC

The sensor is connected to the PC via the IO-Link USB master (see chapter 13.3.1 "Accessories – PC connection").

- ↪ Connect the IO-Link USB master to the plug-in power supply unit or the mains supply.

NOTICE	
	<p>Included in the delivery contents of the IO-Link USB master is a USB interconnection cable for connecting the PC to the IO-Link USB master as well as a plug-in power supply unit and a short description.</p> <p>The mains supply of the IO-Link USB master via the plug-in power supply unit is only activated if IO-Link USB master and PC are connected via the USB interconnection cable.</p>

➤ Connect the PC to the IO-Link USB master.

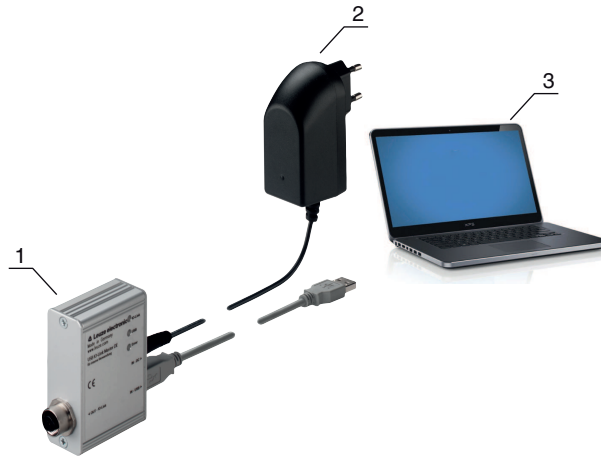

- 1 IO-Link USB master
- 2 Plug-in power supply unit
- 3 PC

Fig. 8.1: PC connection via the IO-Link USB master

➔ The **wizard for searching for new hardware** starts and installs the driver for the IO-Link USB master on the PC.

8.2.5 Connecting IO-Link USB master to the sensor

Prerequisites:

- IO-Link USB master and PC are connected via the USB interconnection cable.
- IO-Link USB master is connected to the mains supply with the plug-in power supply unit.

NOTICE



Connect the plug-in power supply unit for IO-Link USB master!

➤ To connect the sensor, the plug-in power supply unit must be connected to the IO-Link USB master and the mains supply. The voltage supply via the USB interface of the PC is permissible only for IO-devices with a current consumption of up to 40 mA at 24 V.

NOTICE



Included in the delivery contents of the IO-Link USB master is a USB interconnection cable for connecting the PC to the IO-Link USB master as well as a plug-in power supply unit and a short description.

The mains supply of the IO-Link USB master via the plug-in power supply unit is only activated if IO-Link USB master and PC are connected via the USB interconnection cable.

➤ Connect the IO-Link USB master to the M12 connection of the sensor via an interconnection cable. The interconnection cable is not included in the delivery contents and must be ordered separately if needed (see chapter 13.3.1 "Accessories – PC connection").

8.2.6 Installing the DTM and IODD

Prerequisites:

- The sensor is connected to the PC via the IO-Link USB master.
 - FDT frame and driver for IO-Link USB master are installed on the PC.
- ↩ Select the **IO-Link device DTM (User Interface)** installation option and follow the instructions on the screen.
- ⇒ The installation wizard installs the DTM and the IO Device Description (IODD) for the sensor.

NOTICE	
	DTM and IODD for all IO-Link devices currently available from Leuze electronic are installed.

8.2.7 Importing device descriptions

Proceed as follows to manually add device descriptions (DTM and IODD):

- ↩ Unpack the downloaded ZIP file (e.g. *Leuze_electronic-ODS10-20160405-IODD1.1.zip*) to a suitable directory on your hard drive, e.g. *ODS10-20160405-IODD1.1*.
- ↩ Copy the directory *ODS10-20160405-IODD1.1* to the following directory:
C:\ProgramData\Leuze electronic\IO-Link Device DTM\IO-Link DDs
- ↩ Open the *Sensor Studio* configuration software. If a project is already open, close it using the menu command **File > New**.
- ↩ Update the DTM general catalog: **Tools > DTM catalog management**:
Click the [Find installed DTMs] button.
Mark the required DTMs in the *Known DTMS* list and move them to the *Current DTM catalog* list ([>] button). You need at least the DTM for the used sensor and the communication DTM IO-Link USB Master 2.0.
- ↩ Click [OK] to exit DTM catalog management.

8.3 Starting the Sensor Studio configuration software

Prerequisites:

- The sensor has been mounted (see chapter 5 "Mounting") and connected (see chapter 6 "Electrical connection") correctly.
 - The *Sensor Studio* configuration software is installed on the PC (see chapter 8.2 "Installing Sensor Studio configuration software and IO-Link USB master").
 - The sensor is connected to the PC via the IO-Link USB master (see chapter 8.2 "Installing Sensor Studio configuration software and IO-Link USB master").
- ↩ Start the *Sensor Studio* configuration software by double-clicking the *Sensor Studio* icon (.
- ⇒ The **mode selection** of the **project wizard** is displayed

- ↪ Select the **Device selection without communication connection (offline)** configuration mode and click on [Next].
- ⇒ The **Project Wizard** displays the **device selection** list of the configurable devices.

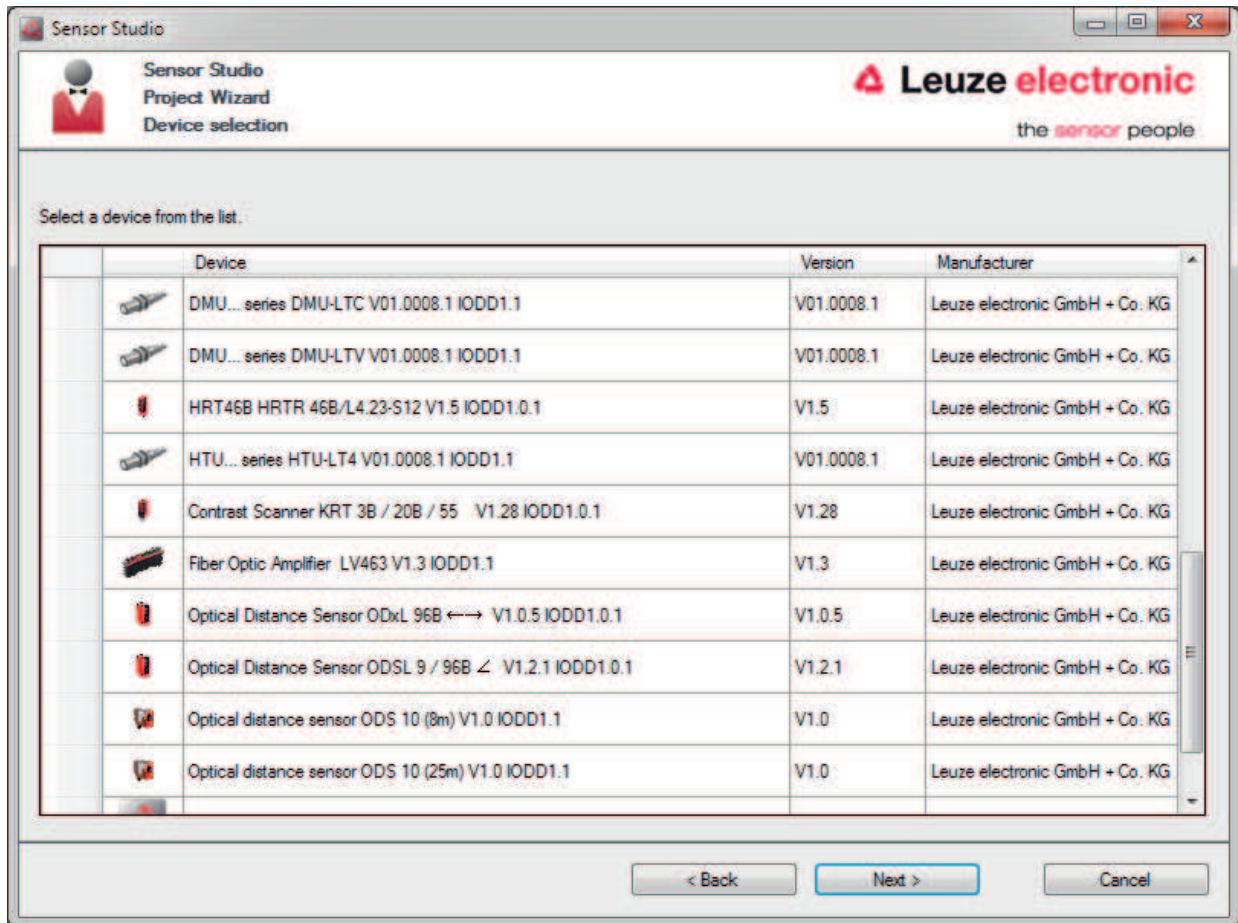

Fig. 8.2: Device selection

- ↪ Select the connected sensor according to the configuration in the **device selection** and click on [Next].
- ⇒ The device manager (DTM) of the connected sensor starts with the offline view for the *Sensor Studio* configuration project.
- ↪ Establish the online connection to the connected sensor.
 In the *Sensor Studio* FDT frame, click on the [Establish connection with device] button (▶).
 In the *Sensor Studio* FDT frame, click on the [Online parameters] button (P).
- ⇒ The IO-Link USB master synchronizes with the connected sensor and the current configuration data and measurement data are displayed in the device manager (DTM).

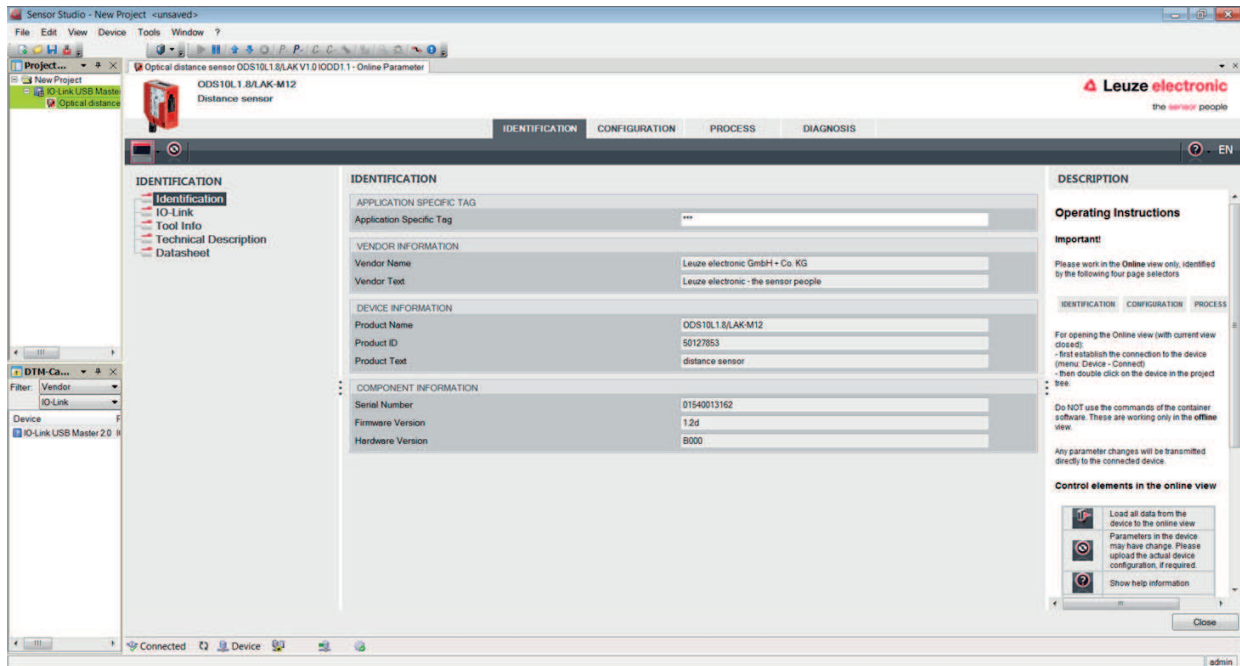



Fig. 8.3: Configuration project: *Sensor Studio* device manager (DTM) for ODS 10

- ↳ The menus of the *Sensor Studio* device manager (DTM) can be used to change or read out the configuration or process data of the connected sensor.
- The user interface of the *Sensor Studio* device manager (DTM) is largely self-explanatory.
- The online help system provides information on the menu items and adjustment parameters.
- Select the **Help** menu item in the menu [?]

8.4 Short description of the *Sensor Studio* configuration software

This chapter contains information and explanations on the individual menu items and adjustment parameters of the *Sensor Studio* configuration software and the device manager (DTM) for the ODS 10 distance sensor.

NOTICE	
	<p>This chapter does not include a complete description of the <i>Sensor Studio</i> configuration software.</p> <p>Complete information on the FDT frame menu and on the functions in the device manager (DTM) can be found in the online help system.</p>

The device manager (DTM) of the *Sensor Studio* configuration software has the following main menus and functions:

- *IDENTIFICATION* (see chapter 8.4.2 "IDENTIFICATION function")
- *CONFIGURATION* (see chapter 8.4.3 "CONFIGURATION function")
- *PROCESS* (see chapter 8.4.4 "PROCESS function")
- *DIAGNOSIS* (see chapter 8.4.5 "DIAGNOSIS function")

NOTICE	
	<p>The online help system displays information on the menu items and adjustment parameters for each function. Select the Help menu item in the menu [?].</p>

8.4.1 FDT frame menu

NOTICE	
	<p>You can find complete information on the FDT frame menu in the online help system. Select the Help menu item in the menu [?].</p>

8.4.2 IDENTIFICATION function

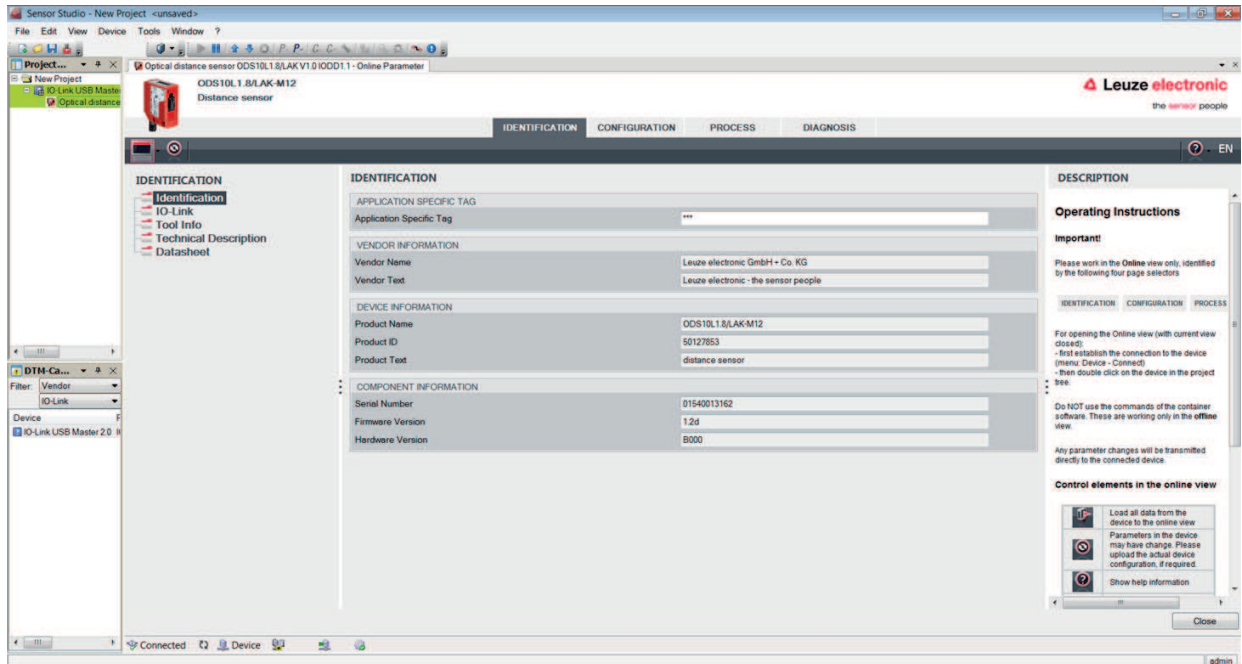

Fig. 8.4: IDENTIFICATION function

- Device information, e.g., designation, order no., serial number, etc.
- Information on the IO-Link parameters of the connected sensor, e.g., Device ID, cycle time, etc.
- Assignment of the teach-in functions to the power levels defined by the duration of the teach signal
Optional for devices with input (see chapter 7.1.2 "Teaching the analog output", see chapter 7.2.2 "Teaching the switching outputs")
- Technical description of the connected sensor
- Data sheet of the connected sensor

8.4.3 CONFIGURATION function

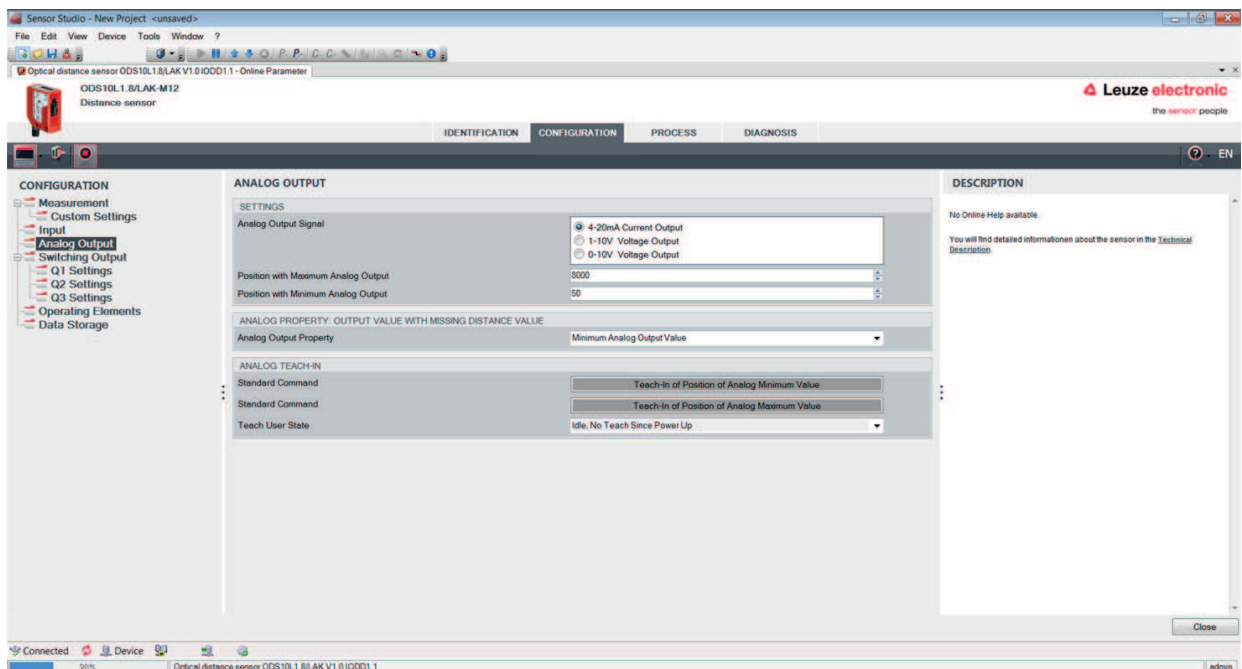

Fig. 8.5: CONFIGURATION function

- Configuration of measure mode
- Configuration of analog output functions
- Configuration of digital switching inputs/outputs
- Configuration of local control
- Configuration of data storage

Deactivation property

This function is used to determine whether, when the sensor is deactivated, the most recent measurement value to be output is **frozen** or whether the sensor does not output a measurement value at all. The switching outputs which are dependent on the measurement value, and an analog output (if present) behave according to the output measurement value.

- Frozen: The most recent measurement value to be output is **frozen** (default).



Fig. 8.6: Display: Measurement value **frozen** in the case of deactivation

- No Signal: No measurement value is output



Fig. 8.7: Display: No measurement value in the case of deactivation

Input function: Activating/deactivating sensor via switching input

The following options are available:

- Activation: Voltage on the multifunction input activates the sensor
- Deactivation: Voltage on the multifunction input deactivates the sensor
- No function
- Teach

NOTICE	
	If you select the input functions <i>Activation</i> or <i>Deactivation</i> , the IO-Link system commands of the same name (176, 177) have no effect.

Data storage

The current status of the *DSUpload* (Data Storage Upload) flag stored in the non-volatile memory of the sensor is displayed, provided that cyclical updating is active.

The following functions for changing the *DSUpload* flag are available:

- *Set DSUpload Flag*: Local configuration changes at the sensor remain saved when an IO-Link master is connected, and are transferred to the IO-Link master.
- *Clear DSUpload Flag*: Local configuration changes at the sensor are overwritten when an IO-Link master is connected.

Local configuration lock

This button is used to disable the sensor. Operation via the OLED display and keyboard is only possible after deactivation of the lock via IO-Link or using the configuration software *Sensor Studio*.

8.4.4 PROCESS function

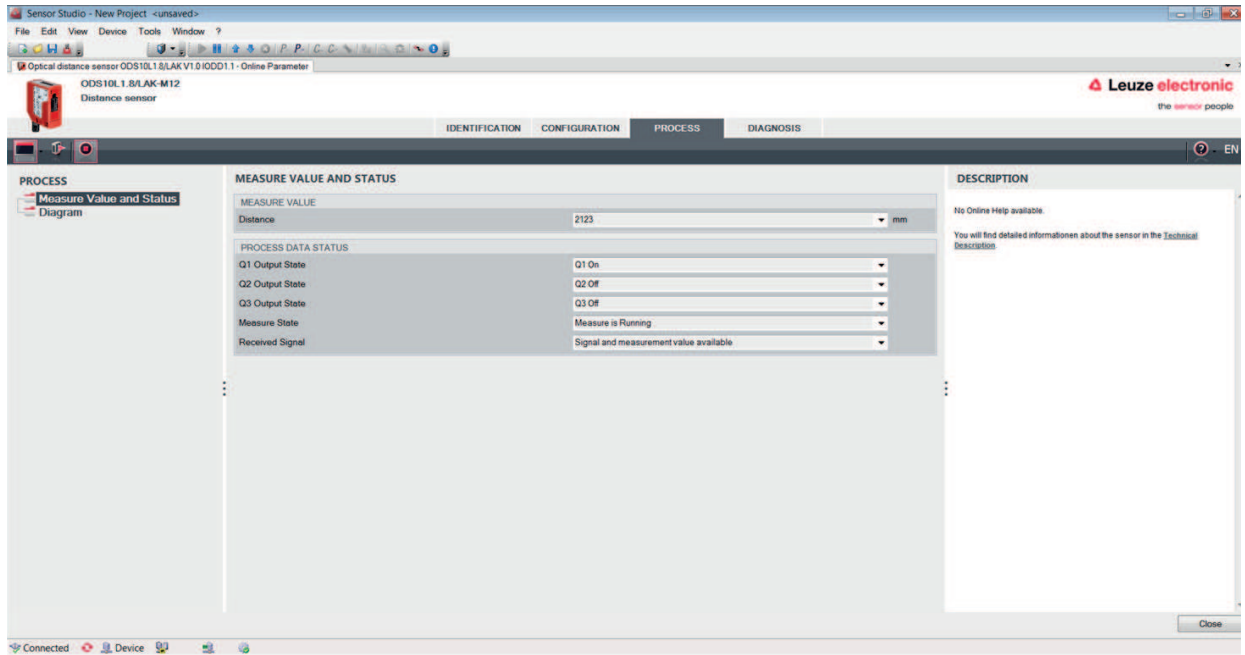

Fig. 8.8: PROCESS function

- Visualization of the distance value and the states of the digital output signals.
Text-based display of the current values:

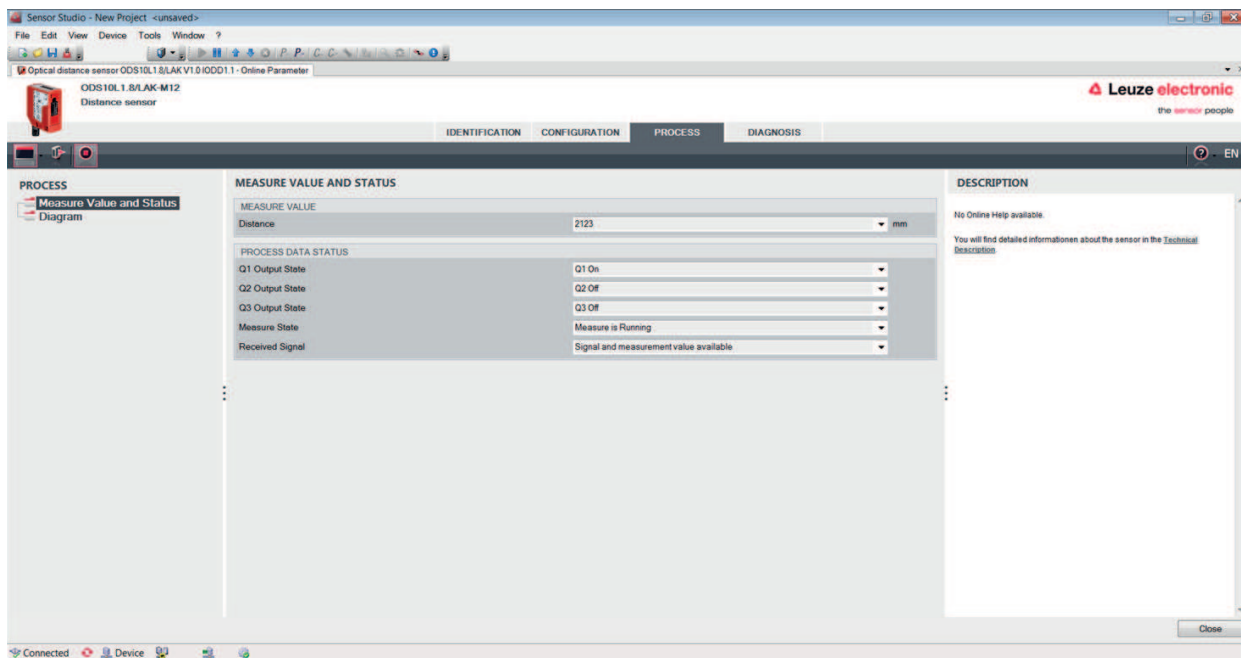

Fig. 8.9: PROCESS function – distance value and status

- Graphical display of the recorded measurement values, including the history:

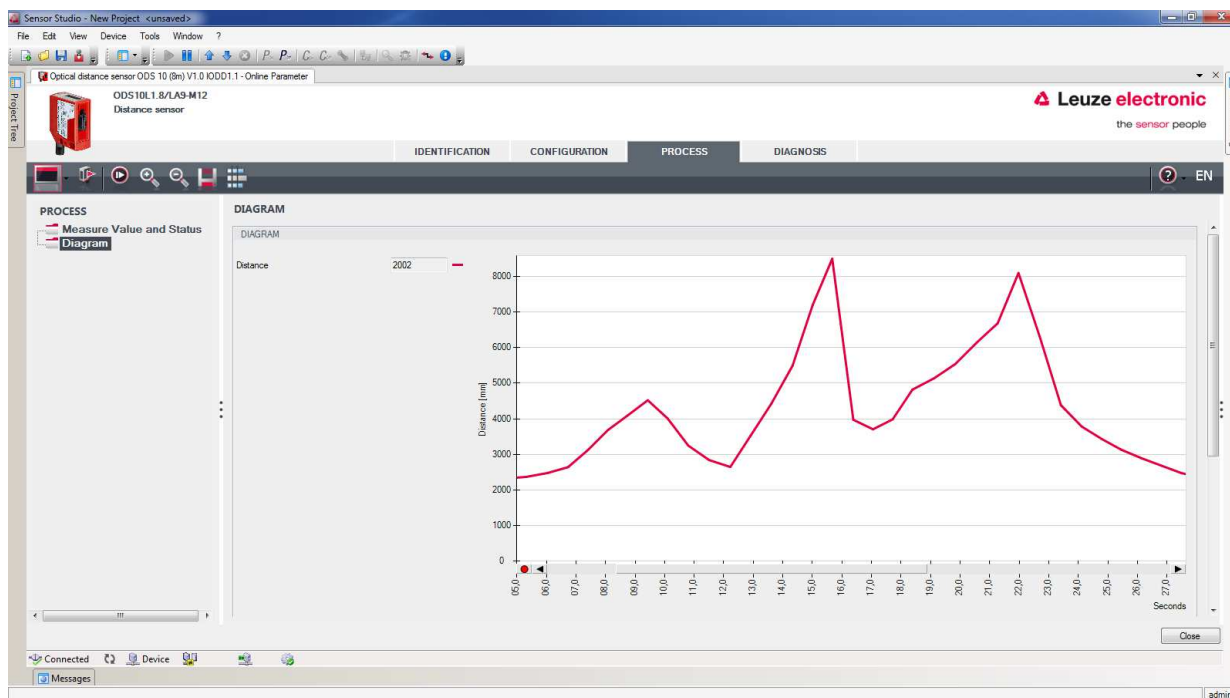

Fig. 8.10: PROCESS function – display of the measurement values



Fig. 8.11: PROCESS function – display of the measurement values

8.4.5 DIAGNOSIS function

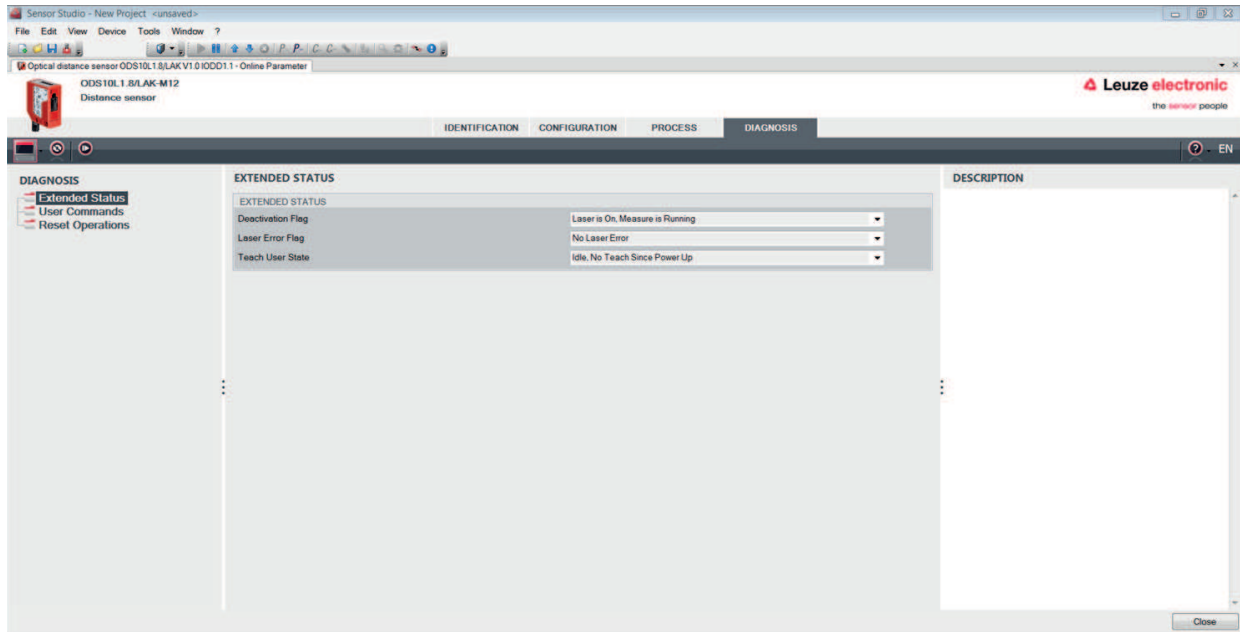

Fig. 8.12: DIAGNOSIS function

- Information on the current device status
- Restart or reset of the device to factory settings
- **User commands**
 - Set or clear the *DSUpload* flag

Set DSUpload Flag: Local configuration changes at the sensor remain saved when an IO-Link master is connected, and are transferred to the IO-Link master.

Clear DSUpload Flag: Local configuration changes at the sensor are overwritten when an IO-Link master is connected.
 - Activate or deactivate the sensor
- Extended settings
 - Gain limitation

This function allows you to optimize the sensor to a specific object. Maximum boosting of the sensor power is limited.

With certain applications, e.g. with compartment fine positioning, the sensor must switch precisely at the racking bases. This requires a light spot which, owing to its laser power, still just switches/ measures at the edge of the racking catch. Excessive power control generates a large halo around the laser spot, resulting in the object being detected too early above the laser spot.

NOTICE	
	Gain limitation must always be set at the object individually and directly in the application.

NOTICE	
	The numerical values in the fields are not equivalent to the object distance. In most cases, it is sufficient to reduce the maximum value.

8.4.6 Exiting Sensor Studio

After completing the configuration settings, close the *Sensor Studio* configuration software.

↳ Exit the program via **File > Exit**.

↳ Save the configuration settings as a configuration project on the PC.

You can open the configuration project again at later time via **File > Open** or via the *Sensor Studio* **project wizard** ()

9 Troubleshooting

9.1 What to do in case of failure?

After switching on the sensor, display elements (see chapter 3.3 "Indicators and operational controls") assist in checking the proper function and troubleshooting.

In case of error, you can determine the error from the LEDs and the indicators on the display. With the error message you can determine the cause of the error and initiate measures to rectify it.

- ↳ Switch off the system and leave it switched off.
- ↳ Analyze the cause of the error using the operation indicators, the error messages and with the help of the *Sensor Studio* configuration software, **DIAGNOSTICS** menu, and rectify the error.

NOTICE	
	<p>Contact Leuze electronic subsidiary/customer service.</p> <p>↳ If you are unable to rectify a fault, contact the Leuze electronic branch responsible for you or call the Leuze electronic customer service (see chapter 11 "Service and support").</p>

9.2 LED indicators

You can use the LED indicators to ascertain general causes of errors (see chapter 3.3.1 "LED indicators").

Tab. 9.1: Green/red LED – causes and measures

Error display	Possible cause	Measures
Orange	Warning message, e.g., weak reception signal	Optimize object alignment
Red	No object detected or reception signal too weak	Position object in the measurement range
Off	<ul style="list-style-type: none"> No supply voltage connected to the sensor Hardware error 	<ul style="list-style-type: none"> Check supply voltage Contact Leuze electronic customer service (see chapter 11 "Service and support")





Tab. 9.2: Yellow LED – causes and measures

Error display	Possible cause	Measures
Off	No object detected in the switching range	Position object in the configured switching range

9.3 Indicators in the display

You can use the status indicators in the display to ascertain general error causes; (see chapter 3.3.3 "Display").

Tab. 9.3: Display indicators – causes and measures

Display	Possible cause	Measures
	Warning message, e.g., weak reception signal	Optimize object alignment
	No object detected or reception signal too weak	Position object in the measurement range
	Signal failure Sensor defective	If the icon is displayed continuously: contact Leuze electronic customer service (see chapter 11 "Service and support")
	The current measurement value is less than the lower limit of the analog output distance	Change the setting for the lower limit of the measurement range (see chapter 3.4.4 "Analog Output menu")
	The current measurement value is greater than the upper limit of the analog output distance	Change the setting for the upper limit of the measurement range (see chapter 3.4.4 "Analog Output menu")

10 Care, maintenance and disposal

10.1 Cleaning

If there is dust on the device:

- ↳ Clean the device with a soft cloth; use a cleaning agent (commercially available glass cleaner) if necessary.

NOTICE



Do not use aggressive cleaning agents!

- ↳ Do not use aggressive cleaning agents such as thinner or acetone for cleaning the device. Use of improper cleaning agents can damage the lens cover.

10.2 Servicing

The device does not normally require any maintenance by the operator.

Repairs to the device must only be carried out by the manufacturer.

- ↳ For repairs, contact your responsible Leuze electronic subsidiary or Leuze electronic customer service (see chapter 11 "Service and support").

10.3 Disposing

- ↳ For disposal observe the applicable national regulations regarding electronic components.

11 Service and support

24-hour on-call service at:

+49 (0) 7021 573 - 0

Service hotline:

+49 (0) 7021 573 - 123

Monday to Friday 8.00 a.m. to 5.00 p.m. (UTC+1)

E-mail:

service.identify@leuze.de

Repair service and returns:

Procedure and Internet form can be found at

www.leuze.com/repair

Return address for repairs:

Service center

Leuze electronic GmbH + Co. KG

In der Braike 1

D-73277 Owen / Germany

11.1 What to do should servicing be required?

NOTICE



Please use this chapter as a master copy should servicing be required!

Enter the contact information and fax the form together with your service order to the fax number given below.

Customer data (please complete)

Device type:	
Serial number:	
Firmware:	
Display messages:	
Status of LEDs:	
Error description:	
Company:	
Contact person/department:	
Phone (direct dial):	
Fax:	
Street/No:	
ZIP code/City:	
Country:	

Leuze Service fax number:

+49 7021 573 - 199

12 Technical data

12.1 Measurement data

Tab. 12.1: Measurement ranges

50 mm ... 3500 mm	6 % ... 90 % diffuse reflection Measurement against diffusely reflective objects
50 mm ... 8000 mm	90 % diffuse reflection Measurement against diffusely reflective objects
100 mm ... 25000 mm	Measurement against reflective tape 7-A (50111527) (all ODS10L1-25M.8 devices)

Tab. 12.2: Accuracy

Resolution	1 mm
Temperature drift	≤ ±2 mm/K
Accuracy*	ODS10L1.8/... devices: ≤ ±15 mm ODS10L1-25M.8/... devices: ≤ ±25 mm
*: Typical values for	<ul style="list-style-type: none"> • Measurement range: 50 ... 3500 mm • Diffuse reflection: 6 % ... 90 % • Measure mode: Standard • At 20°C after warmup time of 20 minutes

Tab. 12.3: Measure modes and time behavior (see chapter 3.4.5 "Application menu")

Measure mode	Response time	Output time
Fast	15 ms	3.4 ms
Standard	50 ms	3.4 ms
Precision	200 ms	3.4 ms
High precision	1000 ms	3.4 ms
Individual	3.4 ms ... 1020 ms	3.4 ms
Outlier suppression	17 ms ... 1020 ms	17 ms ... 1020 ms

Reproducibility

- Statistical value: 1 sigma
- Measurement object ≥ 50 x 50 mm²
- Diffuse reflectance: 6 % ... 90 %
- At 20 °C after warmup time of 20 minutes

Tab. 12.4: Measure modes and reproducibility

Measure mode	Reproducibility
Fast	2 mm ... 4 mm
Standard	1 mm ... 2 mm
Precision	0.5 mm ... 1 mm
High precision	0 mm ... 0.5 mm

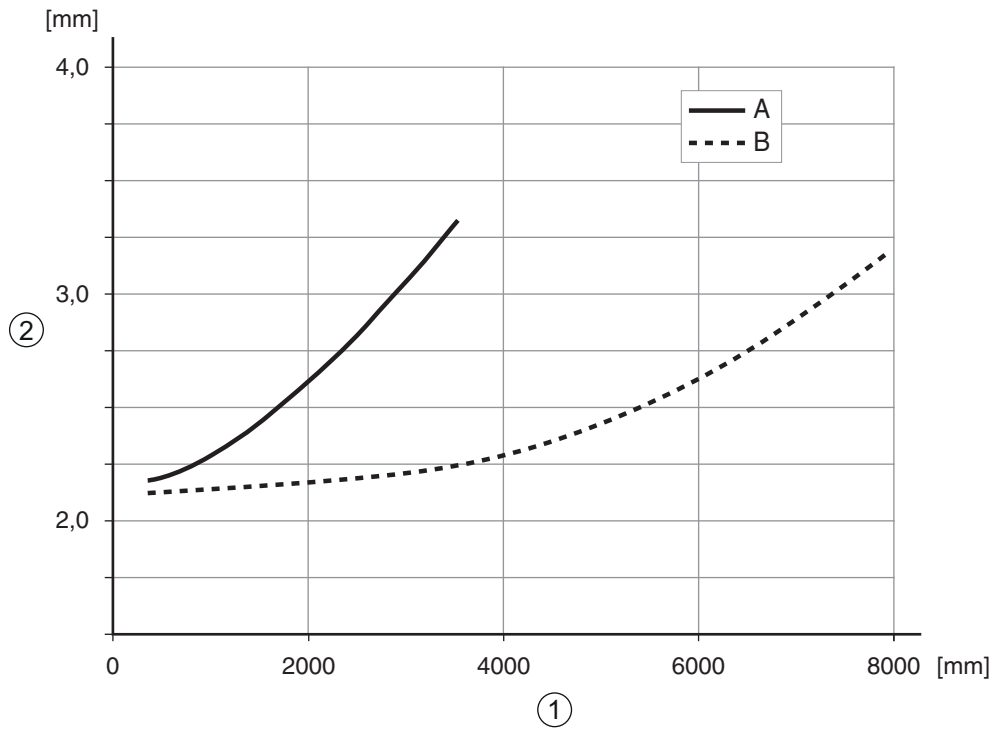

- 1 Object distance
- 2 Reproducibility
- A At 6% diffuse reflection
- B At 90% diffuse reflection

Fig. 12.1: Typical reproducibility – Fast measure mode

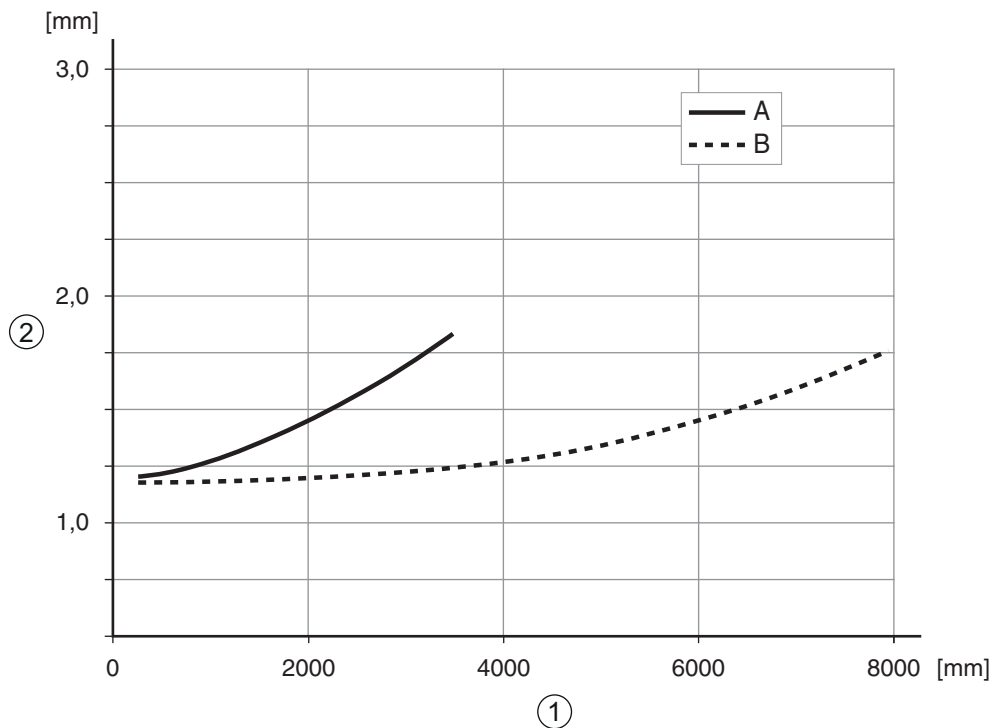

- 1 Object distance
- 2 Reproducibility
- A At 6% diffuse reflection
- B At 90% diffuse reflection

Fig. 12.2: Typical reproducibility – Standard measure mode

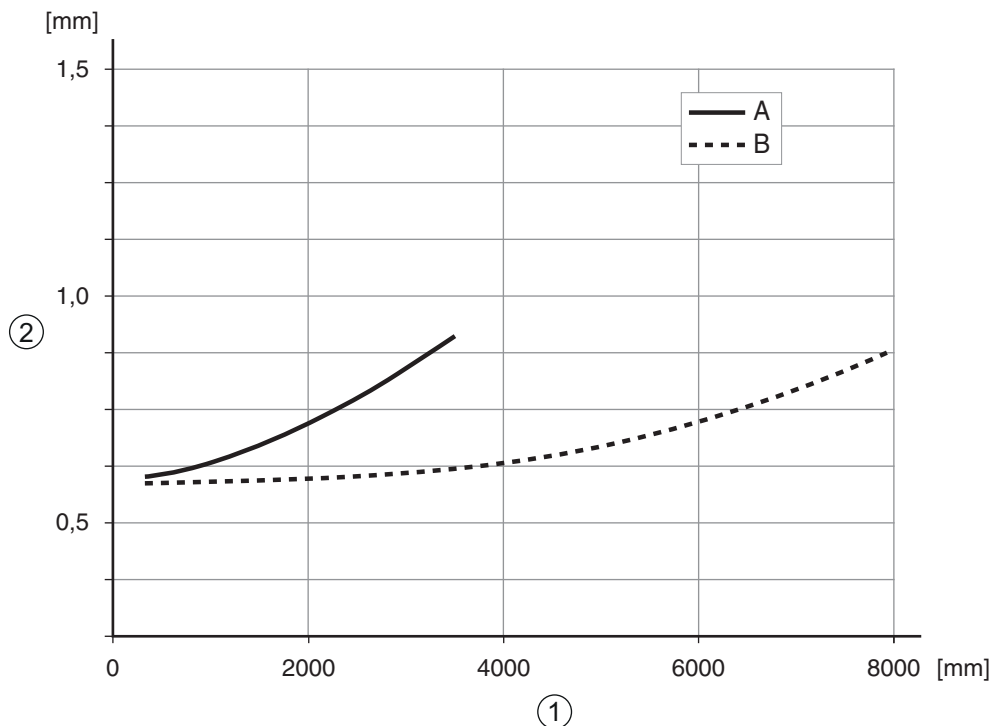

- 1 Object distance
- 2 Reproducibility
- A At 6% diffuse reflection
- B At 90% diffuse reflection

Fig. 12.3: Typical reproducibility – Precision measure mode

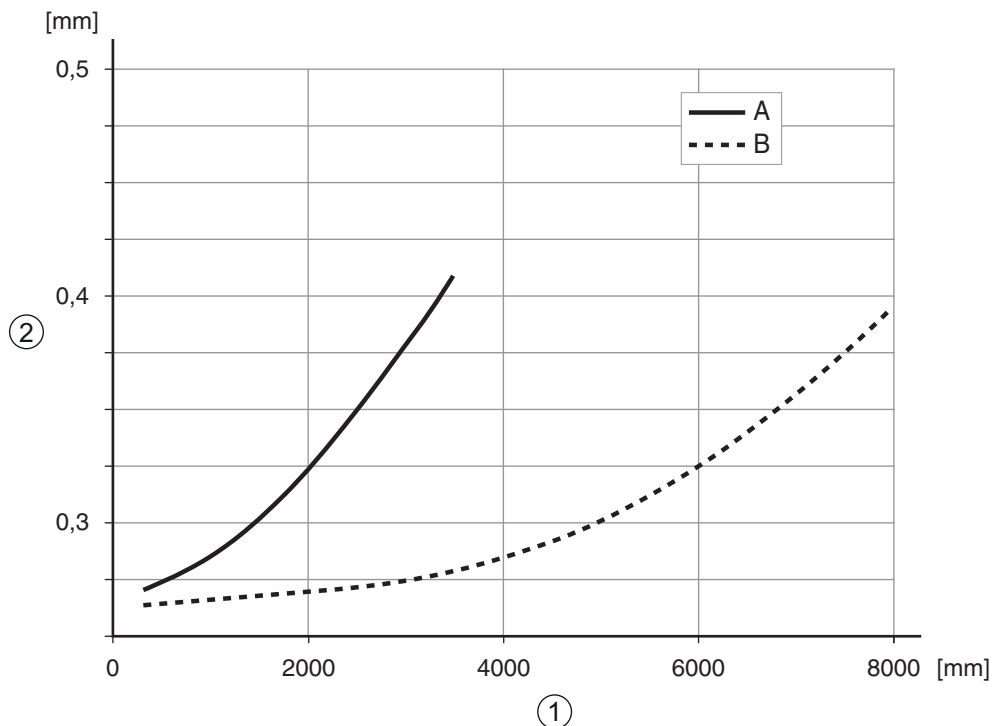

- 1 Object distance
- 2 Reproducibility
- A At 6% diffuse reflection
- B At 90% diffuse reflection

Fig. 12.4: Typical reproducibility – High precision measure mode

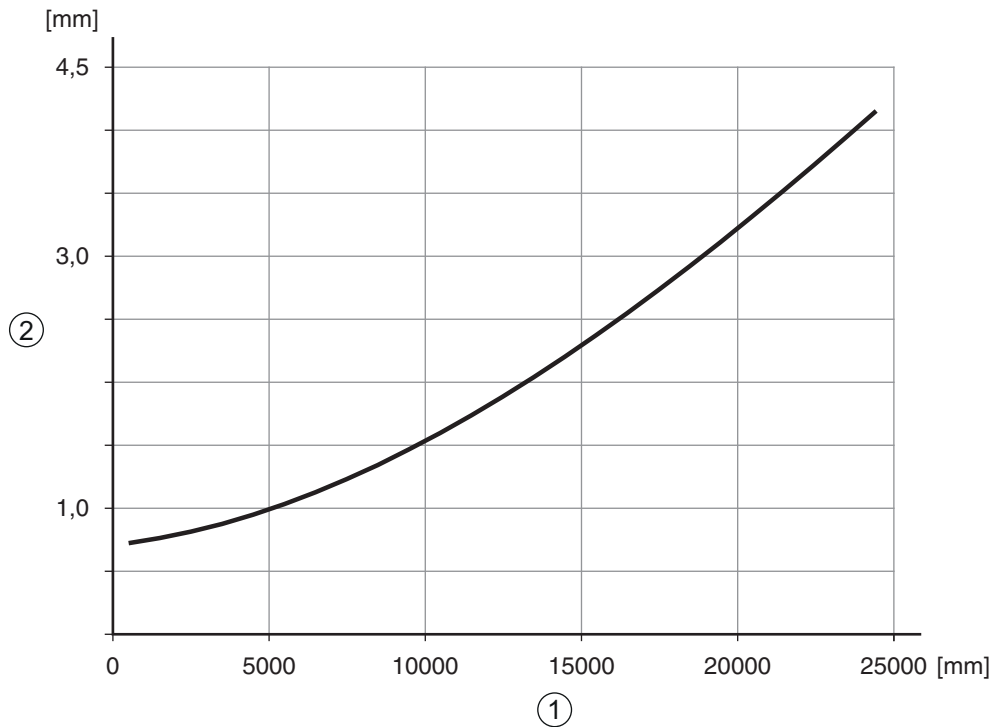

Reproducibility on reflective tape

Measure mode *Standard*

- 1 Measurement distance
- 2 Reproducibility

Fig. 12.5: Typical reproducibility for ODS10L1-25M.8 devices

12.2 Optical data

Tab. 12.5: Optical data

Light source	Laser diode Laser class 1 acc. to IEC 60825-1:2007
Wavelength	658 nm (red, visible)
Pulse duration	6 ns
Max. output power (peak)	391 mW
Light spot	Approx. 7 mm x 7 mm at a distance of 4 m

12.3 Indicators and operational controls

Tab. 12.6: Indicators/operational controls

Display	OLED display
Keyboard	Two buttons
LEDs	<p>PWR: Status LED on the control panel, two-colored (red/green)</p> <p>Q1: LED for object detection/switching output Q1 yellow</p> <ul style="list-style-type: none"> • On the lens cover • On the control panel <p>Q2: LED for object detection/switching output Q2 yellow (ODS10L1.8/LA6)</p> <ul style="list-style-type: none"> • On the lens cover • On the control panel

12.4 Electrical data

Tab. 12.7: Electrical equipment

Operating voltage U_B Supply voltage	18 V ... 30 V DC incl. residual ripple
Residual ripple	$\leq 15\%$ of U_B
Open-circuit current	≤ 150 mA
Switching output	Push-pull switching output NOTICE! The push-pull switching outputs must not be connected in parallel.
Signal voltage high/low	$\geq (U_B - 2\text{ V}) / \leq 2\text{ V}$
Analog output ODS10L1.8/LA...	<ul style="list-style-type: none"> • Voltage 1 V ... 10 V / 0 V ... 10 V $R_L \geq 2\text{ k}\Omega$ • Current (factory setting) 4 V ... 20 mA, $R_L \leq 500\ \Omega$
IO-Link	COM2 (38.4 baud), Vers. 1.1 min. cycle time: 2.3 ms SIO is supported

12.5 Mechanical data

Tab. 12.8: Mechanical data

Housing	Plastic
Optics cover	Glass
Weight	Connection type <ul style="list-style-type: none"> • M12 connector: 70 g • Connection cable, 2000 mm: 133 g • Connection cable, 200 mm, with M12 connector: 90 g
Connection type	M12 connector, turnable 90° Connection cable, 2000 mm, wire cross section 5 x 0.14 mm ² (5 x 26 AWG) Connection cable, 200 mm, with M12 connector

12.6 Environmental data

Tab. 12.9: Environmental data

Ambient temperature (operation)	-40 °C ... +50 °C
Ambient temperature (storage)	-40 °C ... +70 °C
Protective circuit	Transient protection Polarity reversal protection Short circuit protection for all outputs
VDE safety class	III
Degree of protection	IP67
Standards applied	IEC 60947-5-2

12.7 Dimensioned drawings

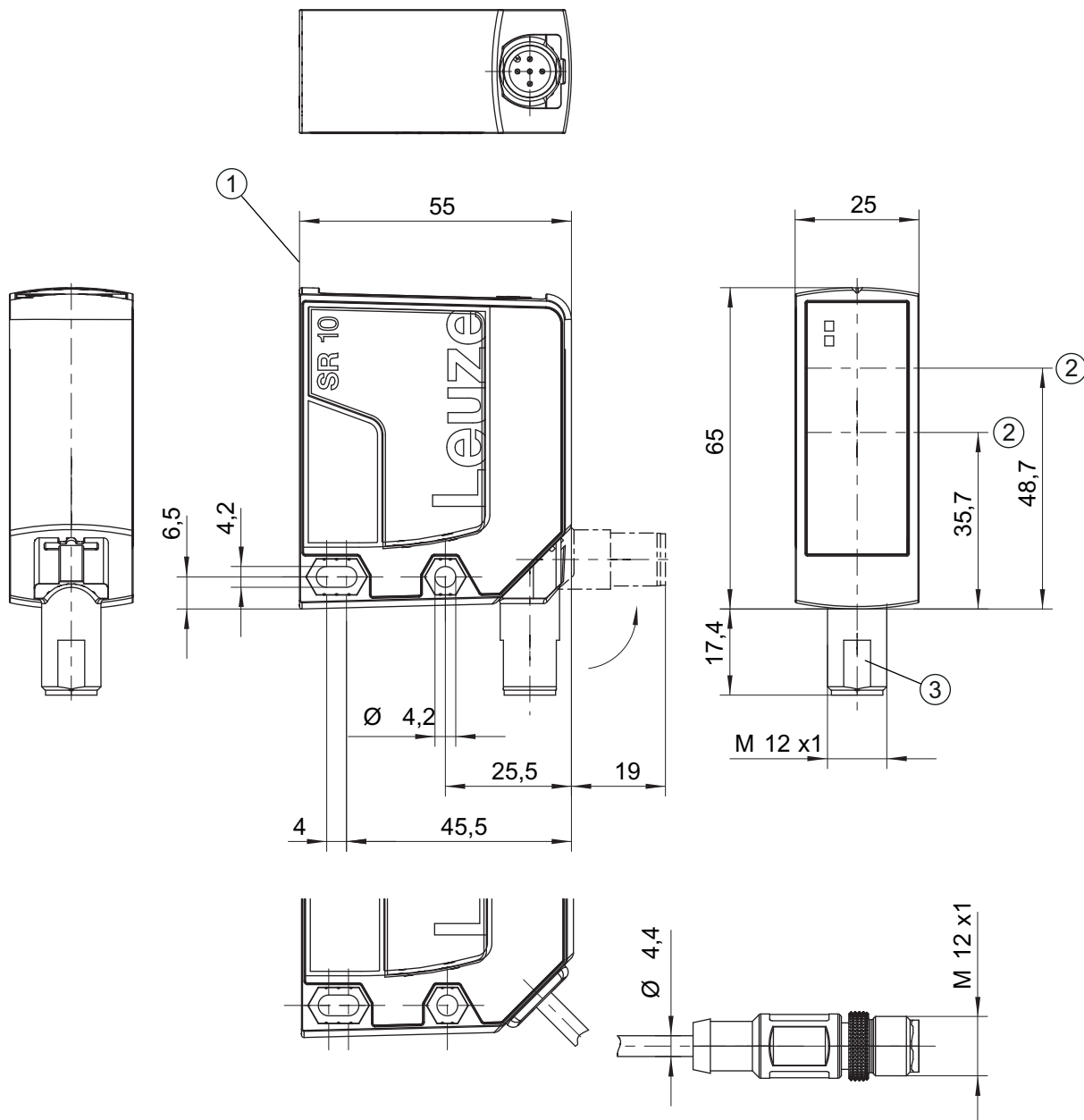

all dimensions in mm

- 1 Reference edge for the measurement
- 2 Optical axis
- 3 M12 connector, turnable 90°

Fig. 12.6: Dimensioned drawing ODS 10 with M12 connector

12.8 Dimensional drawings: Accessories

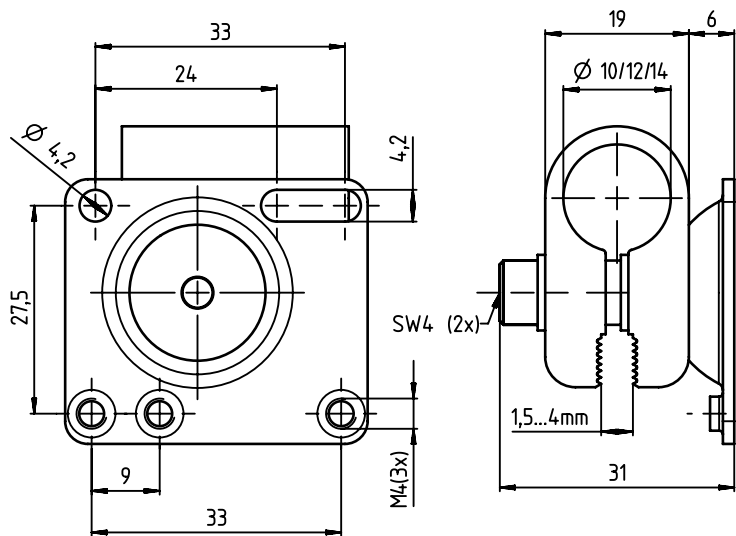

all dimensions in mm

Fig. 12.7: Dimensioned drawing mounting system BTU 300M-D10/D12/D14

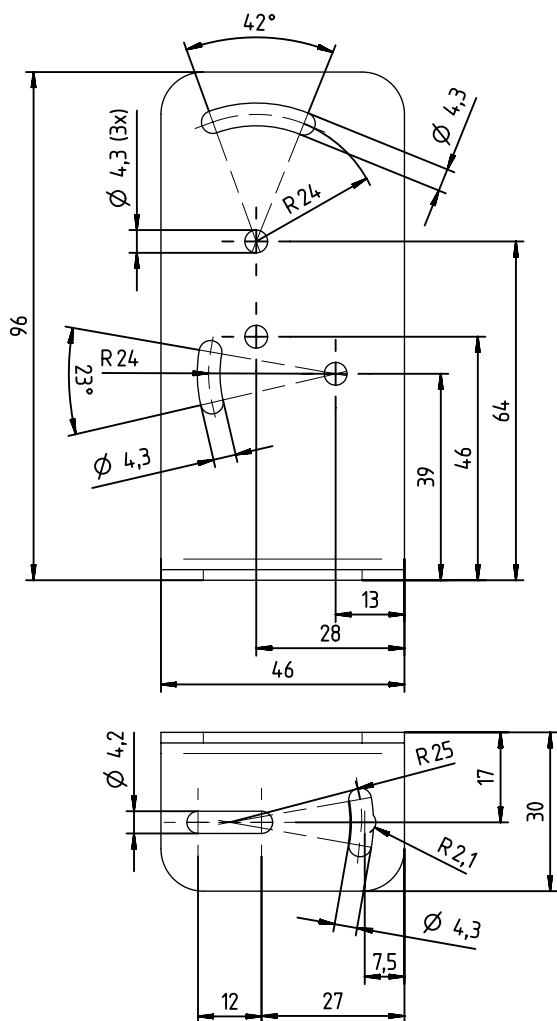

all dimensions in mm

Fig. 12.8: Dimensioned drawing mounting bracket BT 300M.5

13 Order guide and accessories

13.1 Type overview ODS 10

Optical distance sensors, measurement against object

- Maximum measurement range: 8000 mm
- Connection: M12 connector, 5-pin

Part no.	Part designation	Description
50127853	ODS10L1.8/LAK-M12	IO-Link 1.1, analog output, multifunction input, 1 push-pull switching output
50129528	ODS10L1.8/L6X-M12	IO-Link 1.1, 2 push-pull switching outputs
50129529	ODS10L1.8/LA6-M12	IO-Link 1.1, analog output, 2 push-pull switching outputs

Optical distance sensors, measurement against object

- Maximum measurement range: 8000 mm
- Connection: cable, length 2000 mm, with wire-end sleeves, 5-wire

Part no.	Part designation	Description
50129531	ODS10L1.8/LAK	IO-Link 1.1, analog output, multifunction input, 1 push-pull switching output
50129532	ODS10L1.8/LA6	IO-Link 1.1, analog output, 2 push-pull switching outputs

Optical distance sensors, measurement against object

- Maximum measurement range: 8000 mm
- Connection: cable, length 200 mm, with M12 connector, 5-pin

Part no.	Part designation	Description
50129534	ODS10L1.8/LAK, 200-M12	IO-Link 1.1, analog output, multifunction input, 1 push-pull switching output
50129535	ODS10L1.8/LA6, 200-M12	IO-Link 1.1, analog output, 2 push-pull switching outputs

Optical distance sensor, measurement against reflector

- Maximum measurement range: 25000 mm
- Connection: M12 connector, 5-pin

Part no.	Part designation	Description
50129530	ODS10L1-25M.8/LAK-M12	IO-Link 1.1, analog output, multifunction input, 1 push-pull switching output

Optical distance sensor, measurement against reflector

- Maximum measurement range: 25000 mm
- Connection: cable, length 2000 mm, with wire-end sleeves, 5-wire

Part no.	Part designation	Description
50129533	ODS10L1-25M.8/LAK	IO-Link 1.1, analog output, multifunction input, 1 push-pull switching output

Optical distance sensor, measurement against reflector

- Maximum measurement range: 25000 mm
- Connection: cable, length 200 mm, with M12 connector, 5-pin

Part no.	Part designation	Description
50129536	ODS10L1-25M.8/LAK 200-M12	IO-Link 1.1, analog output, multifunction input, 1 push-pull switching output

13.2 Accessories – cables and connectors

Tab. 13.1: Cables and connectors

Part no.	Part designation	Description
50020501	KD 095-5A	M12 connector (cable socket), user-configurable, 5-pin, axial
50020502	KD 095-5	M12 connector (cable socket), user-configurable, 5-pin, angled
50104555	K-D M12A-5P-2m-PVC	Connection cable with M12 connector on one end, 5-pin, M12, axial, length 2 m, PVC sheathing
50104556	K-D M12W-5P-2m-PVC	Connection cable with M12 connector, angled, 5-pin, length 2 m, PVC sheathing
50104557	K-D M12A-5P-5m-PVC	Connection cable with M12 connector on one end, 5-pin, M12, axial, length 5 m, PVC sheathing
50104558	K-D M12W-5P-5m-PVC	Connection cable with M12 connector, angled, 5-pin, length 5 m, PVC sheathing
50104559	K-D M12A-5P-10m-PVC	Connection cable with M12 connector on one end, 5-pin, M12, axial, length 10 m, PVC sheathing
50104560	K-D M12W-5P-10m-PVC	Connection cable with M12 connector, angled, 5-pin, length 10 m, PVC sheathing
50104562	K-D M12W-5P-5m-PUR	PUR connection cable with M12 connector on one end, 5-pin, M12, angled, length 5 m
50104567	K-D M12A-5P-2m-PUR	PUR connection cable with M12 connector on one end, 5-pin, M12, axial, length 2 m
50104568	K-D M12W-5P-2m-PUR	PUR connection cable with M12 connector on one end, 5-pin, M12, angled, length 2 m
50104569	K-D M12A-5P-5m-PUR	PUR connection cable with M12 connector on one end, 5-pin, M12, axial, length 5 m

13.3 Other accessories

Tab. 13.2: Other accessories

Part no.	Part designation	Description
50111527	REF 7-A-100x100	Reflective tape, self-adhesive, 100 mm x 100 mm
50117251	BTU 300M-D14	Mounting system for mounting on rods Ø 14 mm
50117252	BTU 300M-D12	Mounting system for mounting on rods Ø 12 mm
50117253	BTU 300M-D10	Mounting system for mounting on rods Ø 10 mm
50118543	BT 300M.5	Mounting bracket

13.3.1 Accessories – PC connection

Tab. 13.3: Accessories - PC connection configuration

Part no.	Part designation	Description
IO-Link USB master V2.0		
50121098	SET MD12-US2-IL1.1 + accessories	IO-Link USB master V2.0 Plug-in power supply unit (24 V/24 W) with international adapters High-speed USB 2.0 connection cable; USB A to Mini-USB Data carrier with software, drivers and documentation
50110126	K-DS M12A-M12A-4P-2m-PVC	Interconnection cable with M12 connector on both ends, 4-pin, M12, axial, length 2 m, PVC sheathing

14 EC Declaration of Conformity

The optical distance sensor systems of the ODS 10 series were developed and manufactured in accordance with the applicable European standards and directives.

The manufacturer of the product, **Leuze electronic GmbH + Co. KG** in D-73277 Owen, possesses a certified quality assurance system in accordance with ISO 9001.

