

## Technical data sheet

## Throughbeam photoelectric sensor

Part no.: 50137207

LE3CL1.1/LP-M8



Figure can vary

### Contents

- Technical data
- Dimensioned drawings
- Electrical connection
- Operation and display
- Suitable transmitters
- Part number code
- Notes
- Further information
- Accessories



## Technical data

### Basic data

Series	3C
Operating principle	Throughbeam principle
Device type	Receiver

### Optical data

Operating range	Guaranteed operating range
Operating range	0 ... 5 m
Operating range limit	Typical operating range
Operating range limit	0 ... 10 m

### Electrical data

Protective circuit	Polarity reversal protection
	Short circuit protected

### Performance data

Supply voltage $U_B$	10 ... 30 V, DC, Incl. residual ripple
Residual ripple	0 ... 15 %, From $U_B$
Open-circuit current	0 ... 20 mA

### Outputs

Number of digital switching outputs	2 Piece(s)
-------------------------------------	------------

### Switching outputs

Voltage type	DC
Switching current, max.	100 mA
Switching voltage	high: $\geq(U_B - 2V)$
	Low: $\leq 2V$

### Switching output 1

Assignment	Connection 1, pin 4
Switching element	Transistor, Push-pull
Switching principle	IO-Link / light switching (PNP)/dark switching (NPN)

### Switching output 2

Assignment	Connection 1, pin 2
Switching element	Transistor, PNP
Switching principle	Dark switching

### Timing

Switching frequency	1,000 Hz
Response time	0.5 ms
Readiness delay	300 ms

### Interface

Type	IO-Link
------	---------

### IO-Link

COM mode	COM2
Frame type	2.5
Specification	V1.1
SIO-mode support	Yes
Min. cycle time	COM2 = 2.3 ms

### Connection 1

Function	Signal OUT
	Voltage supply
Type of connection	Connector
Thread size	M8
Type	Male
Material	Metal
No. of pins	4 -pin

### Mechanical data

Dimension (W x H x L)	11.4 mm x 34.2 mm x 18.3 mm
Housing material	Plastic
Plastic housing	PC-ABS
Lens cover material	Plastic / PMMA
Net weight	10 g
Housing color	Red
Type of fastening	Through-hole mounting
	Via optional mounting device
Compatibility of materials	ECOLAB

### Operation and display

Type of display	LED
Number of LEDs	2 Piece(s)
Operational controls	270° potentiometer
Function of the operational control	Sensitivity adjustment

### Environmental data

Ambient temperature, operation	-10 ... 60 °C
Ambient temperature, storage	-40 ... 70 °C

### Certifications

Degree of protection	IP 67
	IP 69K
Protection class	III
Certifications	c UL US
Standards applied	IEC 60947-5-2

### Classification

Customs tariff number	85365019
eCl@ss 5.1.4	27270901
eCl@ss 8.0	27270901
eCl@ss 9.0	27270901
eCl@ss 10.0	27270901
eCl@ss 11.0	27270901
ETIM 5.0	EC002716
ETIM 6.0	EC002716
ETIM 7.0	EC002716

# Dimensioned drawings

All dimensions in millimeters

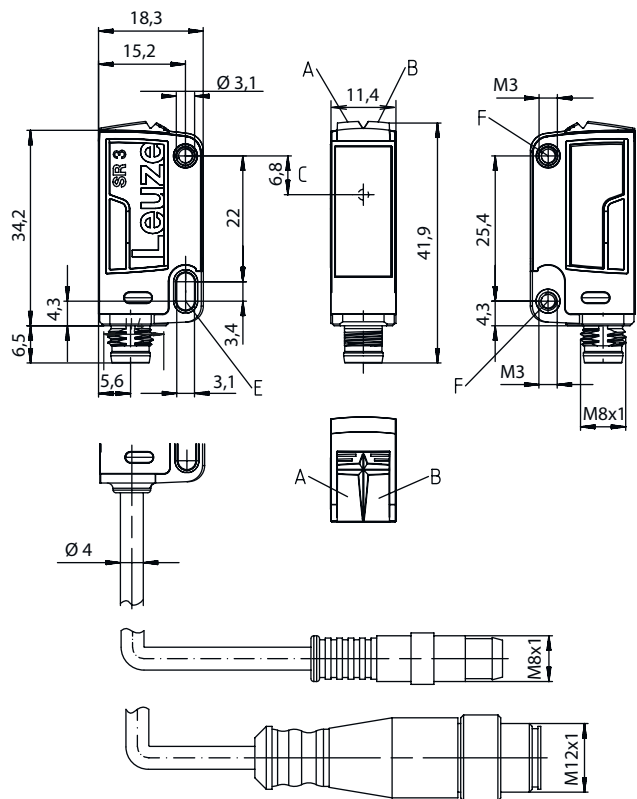

- A Green LED
- B Yellow LED
- C Optical axis
- E Mounting sleeve (standard)
- F Threaded sleeve (3C.B series)

## Electrical connection

### Connection 1

<b>Function</b>	Signal OUT
	Voltage supply
<b>Type of connection</b>	Connector
<b>Thread size</b>	M8
<b>Type</b>	Male
<b>Material</b>	Metal
<b>No. of pins</b>	4 -pin

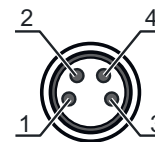

Pin	Pin assignment
1	V+
2	OUT 2
3	GND
4	IO-Link / OUT 1



## Operation and display

LED	Display	Meaning
1	Green, continuous light	Operational readiness
2	Yellow, continuous light	Light path free
	Yellow, flashing	Light path free, no function reserve

## Suitable transmitters

	Part no.	Designation	Article	Description
	50137198	LS3CL1/8X-M8	Throughbeam photoelectric sensor transmitter	Special version: Activation input Operating range limit: 0 ... 10 m Light source: Laser, Red Supply voltage: DC Connection: Connector, M8, Metal, 4 -pin
	50137194	LS3CL1/XX-M8	Throughbeam photoelectric sensor transmitter	Operating range limit: 0 ... 10 m Light source: Laser, Red Supply voltage: DC Connection: Connector, M8, Metal, 4 -pin

## Part number code

Part designation: **AAA 3C d EE-f.GG H/i J-K**

<b>AAA3C</b>	<b>Operating principle / construction</b> HT3C: diffuse reflection sensor with background suppression LS3C: throughbeam photoelectric sensor transmitter LE3C: throughbeam photoelectric sensor receiver PRK3C: retro-reflective photoelectric sensor with polarization filter
<b>d</b>	<b>Light type</b> n/a: red light l: infrared light
<b>EE</b>	<b>Light source</b> n/a: LED L1: laser class 1 L2: laser class 2
<b>f</b>	<b>Preset range (optional)</b> n/a: operating range acc. to data sheet xxxF: preset range [mm]
<b>GG</b>	<b>Equipment</b> n/a: standard A: autocollimation principle (single lens) for positioning tasks B: housing model with two M3 threaded sleeves, brass F: permanently set range L: long light spot S: small light spot T: autocollimation principle (single lens) for highly transparent bottles without tracking TT: autocollimation principle (single lens) for highly transparent bottles with tracking V: V-optics XL: extra long light spot X: extended model
<b>H</b>	<b>Operating range adjustment</b> n/a with HT: range adjustable via 8-turn potentiometer n/a with retro-reflective photoelectric sensors (PRK): operating range not adjustable 1: 270° potentiometer 3: teach-in via button 6: auto-teach
<b>i</b>	<b>Switching output/function OUT 1/IN: Pin 4 or black conductor</b> 2: NPN transistor output, light switching N: NPN transistor output, dark switching 4: PNP transistor output, light switching P: PNP transistor output, dark switching 6: push-pull switching output, PNP light switching, NPN dark switching G: push-pull switching output, PNP dark switching, NPN light switching L: IO-Link interface (SIO mode: PNP light switching, NPN dark switching) 8: activation input (activation with high signal) X: pin not used 1: IO-Link / light switching (NPN) / dark switching (PNP)

## Part number code

<b>J</b>	<b>Switching output / function OUT 2/IN: pin 2 or white conductor</b> 2: NPN transistor output, light switching N: NPN transistor output, dark switching 4: PNP transistor output, light switching P: PNP transistor output, dark switching 6: push-pull switching output, PNP light switching, NPN dark switching G: push-pull switching output, PNP dark switching, NPN light switching W: warning output X: pin not used 8: activation input (activation with high signal) 9: deactivation input (deactivation with high signal) T: teach-in via cable
<b>K</b>	<b>Electrical connection</b> n/a: cable, standard length 2000 mm, 4-wire 5000: cable, standard length 5000 mm, 4-wire M8: M8 connector, 4-pin (plug) M8.3: M8 connector, 3-pin (plug) 200-M8: cable, length 200 mm with M8 connector, 4-pin, axial (plug) 200-M8.3: cable, length 200 mm with M8 connector, 3-pin, axial (plug) 200-M12: cable, length 200 mm with M12 connector, 4-pin, axial (plug)

### Note

	ⓘ A list with all available device types can be found on the Leuze website at <a href="http://www.leuze.com">www.leuze.com</a> .
--	--

## Notes



### Observe intended use!



- ⓘ This product is not a safety sensor and is not intended as personnel protection.
- ⓘ The product may only be put into operation by competent persons.
- ⓘ Only use the product in accordance with its intended use.

### For UL applications:





- ⓘ For UL applications, use is only permitted in Class 2 circuits in accordance with the NEC (National Electric Code).
- ⓘ These proximity switches shall be used with UL Listed Cable assemblies rated 30V, 0.5A min, in the field installation, or equivalent (categories: CYJV/CYJV7 or PVVA/PVVA7)

## Further information



- The push-pull switching outputs must not be connected in parallel.
- Response time: For short decay times, an ohmic load of approx. 5kOhm is recommended
- Sum of the output currents for both outputs, 50 mA for ambient temperatures > 40 °C

## Accessories

### Connection technology - Connection cables

	Part no.	Designation	Article	Description
	50130850	KD U-M8-4A-V1-050	Connection cable	Connection 1: Connector, M8, Axial, Female, 4 -pin Connection 2: Open end Shielded: No Cable length: 5,000 mm Sheathing material: PVC
	50130871	KD U-M8-4W-V1-050	Connection cable	Connection 1: Connector, M8, Angled, Female, 4 -pin Connection 2: Open end Shielded: No Cable length: 5,000 mm Sheathing material: PVC

### Mounting technology - Rod mounts

	Part no.	Designation	Article	Description
	50117829	BTP 200M-D12	Mounting system	Design of mounting device: Protection hood Fastening, at system: For 12 mm rod Mounting bracket, at device: Screw type Type of mounting device: Clampable, Adjustable, Turning, 360° Material: Metal
	50117255	BTU 200M-D12	Mounting system	Design of mounting device: Mounting system Fastening, at system: For 12 mm rod, Sheet-metal mounting Mounting bracket, at device: Screw type, Suited for M3 screws Type of mounting device: Clampable, Adjustable, Turning, 360° Material: Metal

#### Note



A list with all available accessories can be found on the Leuze website in the Download tab of the article detailed page.