

## RSL 400 Safety laser scanner

Safety at Leuze



# Forerunner Yesterday. Today. Tomorrow.

The Sensor People have been setting technological standards in industrial automation for more than 50 years. In the field of safety at work, we convince right from the start with trend-setting inventions, such as the development of the first protective sensor ever, to our latest safety innovation, “Smart Process Gating” – the space-saving solution for access guarding on conveyor lines. This is how we ensure the success of our customers in an industry that is ever evolving.







# Safety at Leuze

Highlights	5
Applications	10
Technical data	20
Suitable products	22

## Innovations successfully combined

The RSL 400 represents the latest generation of our safety laser scanners. Our decades of experience have resulted in a development that is technologically unique and features impressive performance, robustness and many clever functions.

Certain areas on machinery, systems and vehicles must be monitored for safety reasons in order to protect people or prevent collisions. The RSL 400 takes care of this easily and efficiently. Thanks to its high operating range of 8.25 meters and a scanning angle of 270 degrees, it can monitor even large areas. Together with two protective functions, the RSL 400 is able to perform tasks that previously required two scanners.

Many clever functions such as the integrated spirit level, the removable connection unit and the integrated display make commissioning and handling a breeze. Integration into industrial Ethernet networks via PROFIsafe/PROFINET is also supported.

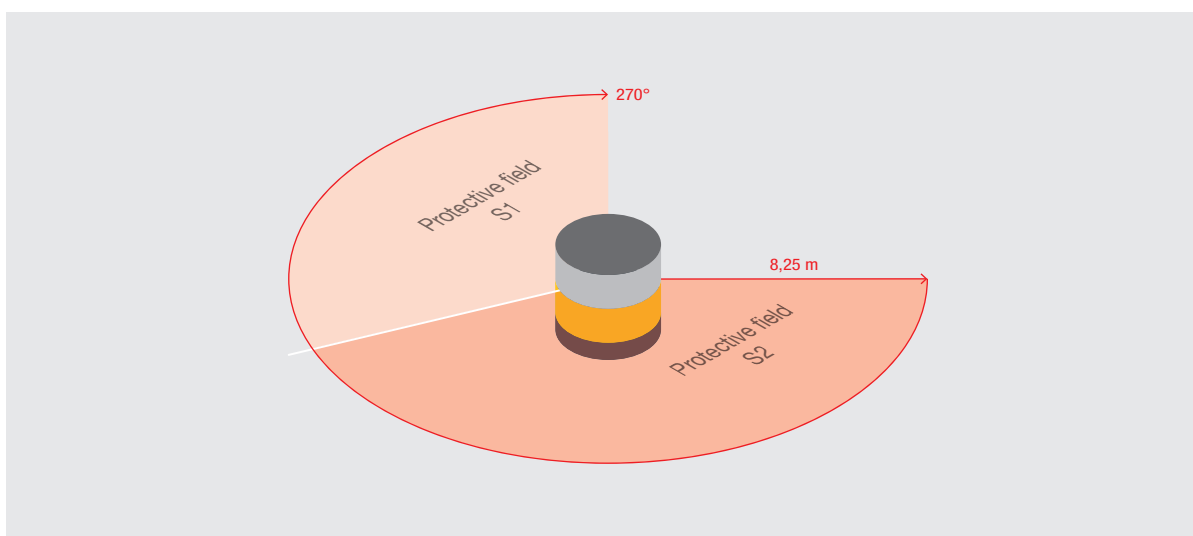

## One-of-a-kind technology

The RSL 400 features a uniquely high angular resolution of 0.1 degrees. This enables high operating ranges and makes the device resistant to dust and particles. The RSL 400 features a very small and even laser light spot, which is also the basis for rendering high-quality measurements.

### Robust in operation



Thanks to its high angular resolution, the RSL 400 is very adept at filtering objects that are not safety-relevant, such as dust and particles in the air. This reduces unnecessary switching off.

### Effective due to rotation

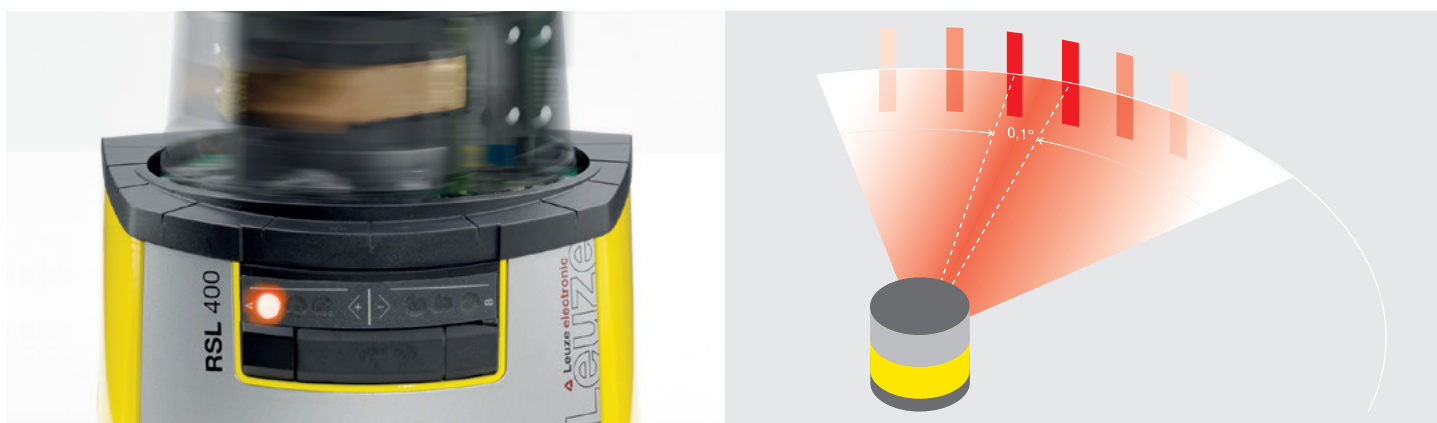

With the RSL 400, the entire transmitter/receiver system rotates. This means an extremely narrow and even laser spot is created over the entire scanning range, which provides the basis for the high angular resolution of 0.1 degree (3x higher sampling compared to conventional scanners).

# Easy handling

The intelligent, removable connection unit facilitates installation and operation. A further feature are the many communication options.

## Removable connection unit



The connection unit of the RSL 400 is removable and can be mounted separately. The scanning head thus remains protected and can simply be attached afterwards.

## Fast device exchange



It takes less than 30 seconds to swap out the scanner: turn two screws by 90° and replace the scanner head. Without realignment, readjusting and configuration effort, as the configuration memory is integrated in the connection unit.

## Three communication options

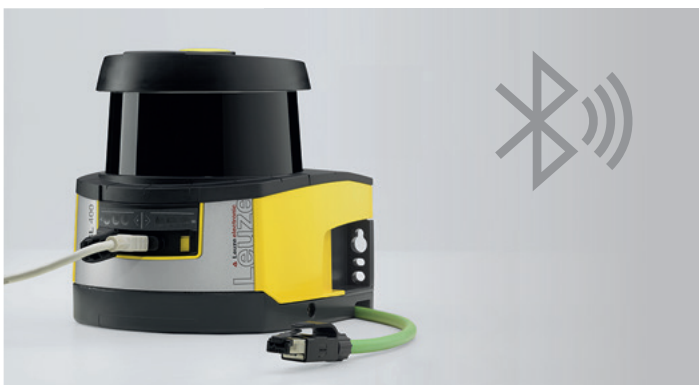

Suitable access is always guaranteed with three means of communication for configuration and diagnosis. In addition, all RSL 400 models are already network-capable thanks to the standard Ethernet-TCP/IP interface, e.g. for diagnosis via central access points.

- Ethernet TCP/IP
- USB (from RSL 420)
- Bluetooth



# Sophisticated in every detail

The RSL 400 is the only safety laser scanner on the market with an integrated display on which the text messages can be easily read, even from a distance of several meters.

## Always an eye on the device status



The bright status LEDs are also easy to see from a distance. Messages and information about protective field violations can be conveniently read off via the integrated display.

## Integrated level



The built-in electronic spirit level allows you to quickly align the device.

## Signature available without PC



If a protective field is interrupted, the signature (CRC checksum) is also provided right on the display.



### Convenient integration in all installation situations

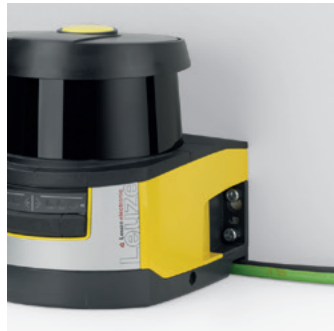

The cable management is sophisticated. The cable routing can be on the side or in the rear, without requiring any additional space.



Integration is particularly easy with the RSL 410, using an 8-pin M12 connector.



Connection units for the RSL 420 to 445 models are available with plugs or cables in selectable lengths.

### Maximum flexibility with 200 fields

The RSL 400 offers maximum flexibility to adapt to the given application with up to 200 configurable fields that can be switched as pairs or sets of four fields. With its two parallel protective functions, the unit works like two devices in one, or

alternatively to a warning field it can provide an additional, upstream protective field. This safeguards the warning function. In the PROFIsafe version, the RSL 400 monitors even four protective fields simultaneously.

#### 1 protective function

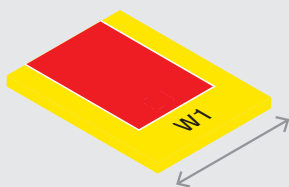

**100 switchable field pairs:**  
1 protective field +  
1 warning field

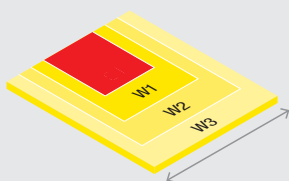

**10 switchable 4-field sets:**  
1 protective field +  
3 warning fields

#### 2 parallel protective functions

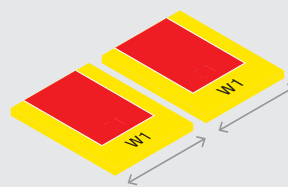

**2 x 10 switchable field pairs:**  
each 1 protective field +  
1 warning field,  
independently switchable

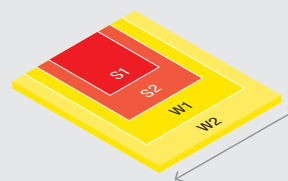

**50 switchable 4-field sets:**  
2 protective fields +  
2 warning fields  
Can also be configured as a  
set with four protective fields  
with PROFIsafe

# Safe in the network

The RSL 400 PROFIsafe with PROFINET interface can easily be integrated in industrial networks. Integration is quick and reliable thanks to the use of standardized connection technology.

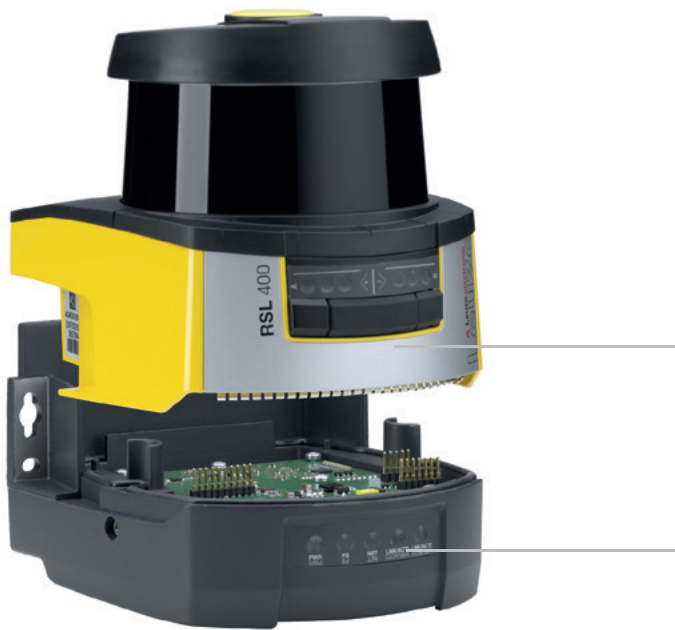

- 2-port switch integrated in connection unit
- Network functions remain intact even if a scanner is swapped out; no network interruptions
- For use in star, line and ring topologies
- Supports PROFINET Conformance Class C and Isochronous Real Time communication (IRT)

Scanner head with PROFIsafe function



Connection unit with integrated PROFINET switch



## Replace without network interruption

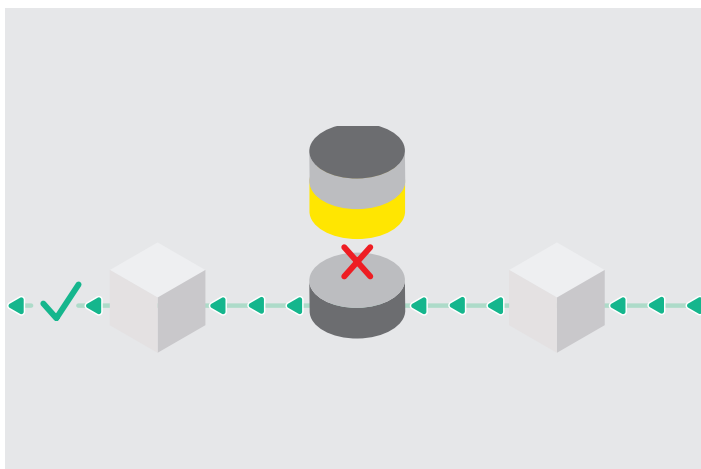

The removable connection unit with a PROFINET switch means the scanner can be replaced without causing an interruption.

## Freely usable display



The RSL 400 outputs text generated by the control with up to 32 characters on the display.

### PROFINET connection unit with standard M12 connections

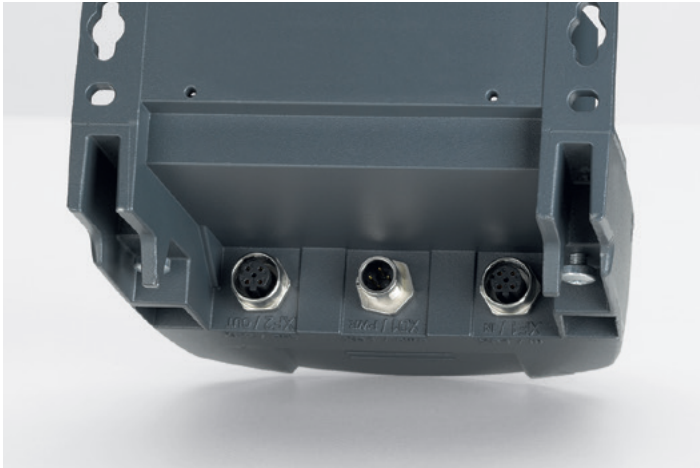

- PROFINET connection unit with industrial M12 connectors for 2-port switch and voltage supply
- Model 4x M12 with additional output for the voltage supply of multiple devices in series connection

### PROFINET connection unit, AIDA-compliant



- AIDA-compliant PROFINET connection unit with push-pull connectors
- Network connection via copper or fiber optic cable

### Area protection for human-robot collaboration

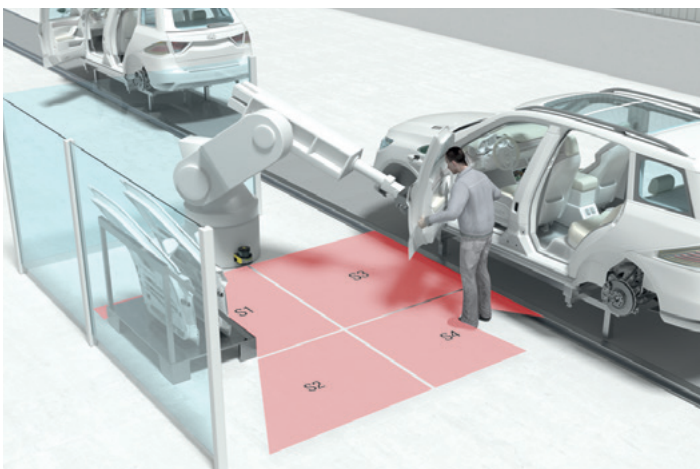

The simultaneous monitoring of four protective fields means the working area can be split up and the speed safely reduced.

### Area protection in automated production plants

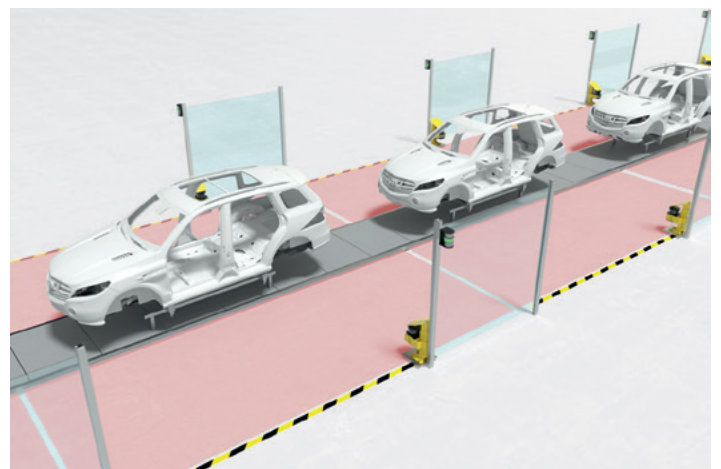

The PROFIsafe/PROFINET interface makes it easy to integrate the unit in industrial Ethernet networks and offers extensive diagnosis options.

# Stationary area protection

The RSL 400 is capable of handling standard tasks with and without protective field switchover as well as applications that previously required two scanners. This is made possible through its high operating range and two protective functions that work in parallel.

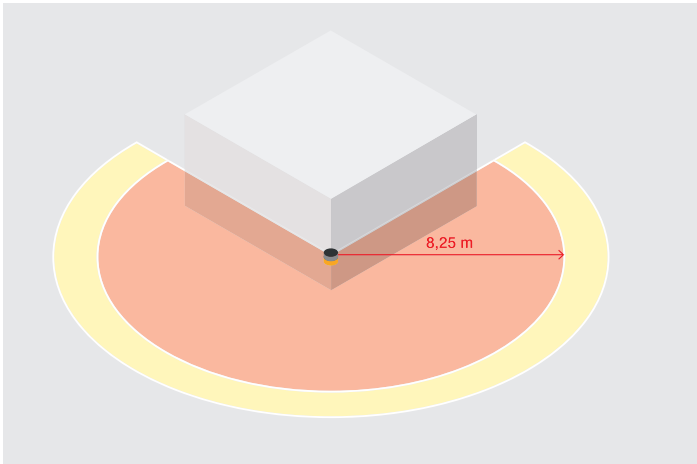

The RSL 400 is characterized by its large scanning range and reliable operation, even under demanding environmental conditions. With operating ranges of up to 8.25 meters, a scanning angle of 270 degrees and the simultaneous monitoring of two protective fields, it solves many tasks that previously required multiple scanners.

- Operating range of up to 8.25 m and 270° scanning angle for covering even large areas with one device
- Especially resistant to particles through 0.1° angular resolution (approx. 3x higher sampling rate than with conventional scanners)
- Parallel monitoring of two protective fields

## Safeguarding of 270° areas at a corner

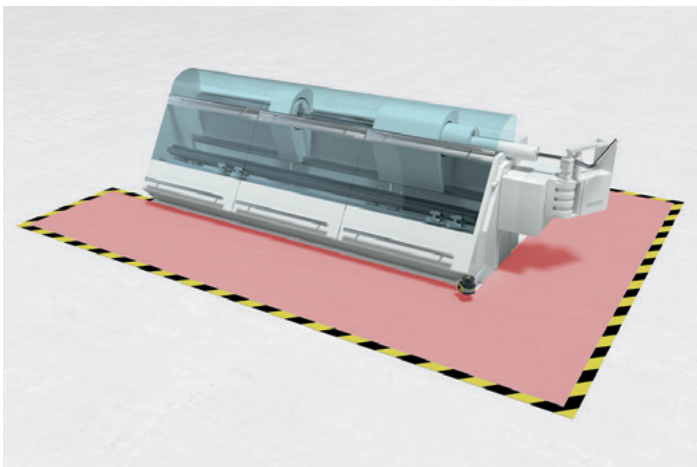

Only one scanner required to safeguard long sides as well as 'around the corner' due to its high operating range and 270° scanning angle.

## Wide-area protection

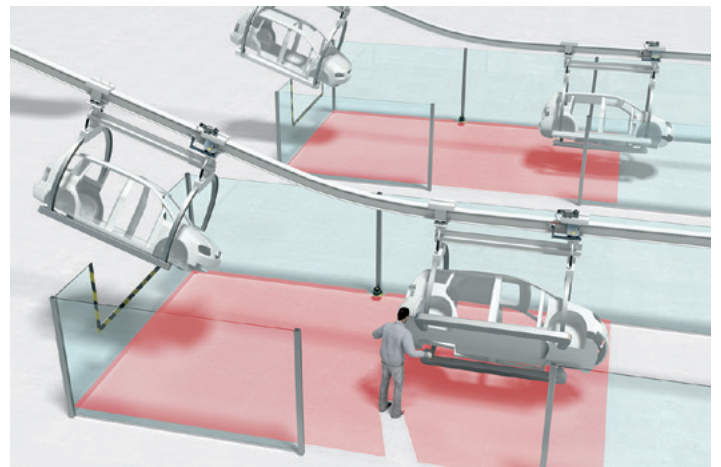

Up to 160 m<sup>2</sup> can be safeguarded with only one scanner.



**RSL 410****Extensive features for standard tasks**

The entry-level model RSL 410 has a range of 8.25 meters in the XL version, thus safeguarding ranges of up to 160 m<sup>2</sup>. It already offers a 4-field set, which enables monitoring of one protective field and up to three warning fields. The functionality is rounded off with selectable resolutions for area and access guarding, three configurable signal outputs and contactor monitoring (EDM).

**RSL 420****For standard tasks with protective field switchover**

In addition to the functions of the RSL 410, the RSL 420 offers switching between ten field pairs or ten 4-field sets. This means it works in monitoring situations where the protective fields need to be adapted to changing conditions.

It also supports chaining with an upstream safety device, such as an emergency stop button or safety light curtain, which in turn reduces the wiring effort.

**RSL 430****2-in-1 solution for stationary applications**

Two OSSD pairs and two independent protective functions with selectable response times: the RSL 430 combines two RSL 420 in one device. Due to the 10+10 reversible field pairs, it can be precisely adapted to the safety tasks.

This means the RSL 430 can handle applications that previously required two scanners. Nine parameterizable I/Os supplement its capabilities.

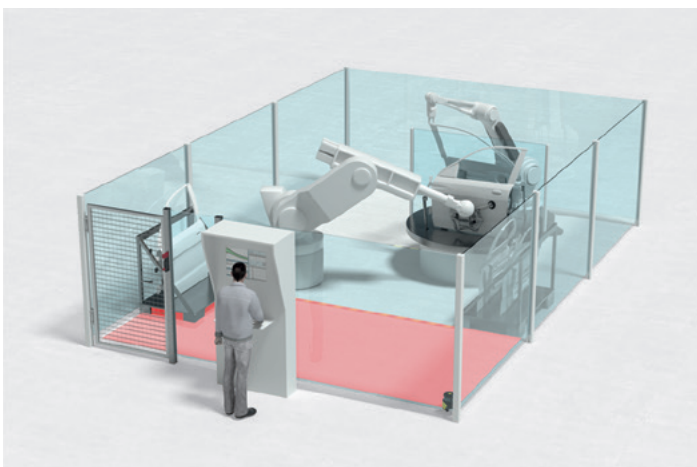
**Monitoring of hidden areas**

Area monitoring with a fixed protective field: typical standard task for the RSL 410.

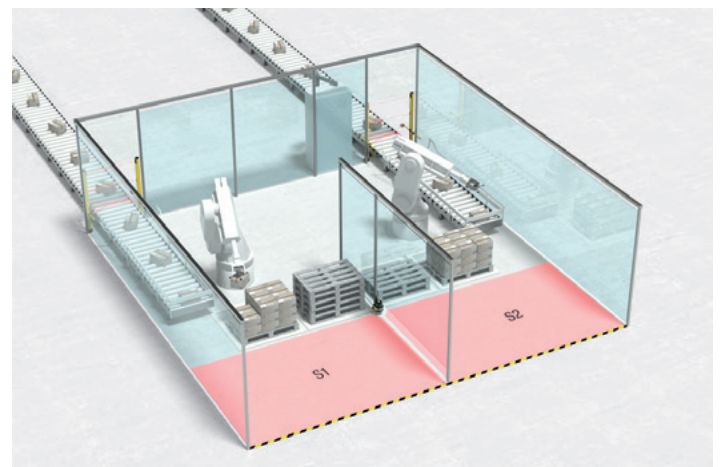
**Simultaneous monitoring of two palletizing stations**

With its two parallel protective functions, the RSL 430 monitors the two stations independently.

# Maximum operating range for all resolutions

The RSL 400 is not only powerful with the standard safety resolution of 70 mm. Even at higher safety resolutions, the unit impresses with extremely large operating ranges.

## Optimum range with all safety resolutions

		Protective field range per RSL model			
		S	M	L	XL
Resolution	70/150 mm	3.00 m	4.50 m	6.25 m	8.25 m
	60 mm	3.00 m	4.50 m	6.25 m	8.25 m
	50 mm	3.00 m	4.50 m	6.25 m	6.25 m
	40 mm	3.00 m	4.50 m	4.50 m	4.50 m
	30 mm	3.00 m	3.50 m	3.50 m	3.50 m

## Powerful when mounted close to the ground

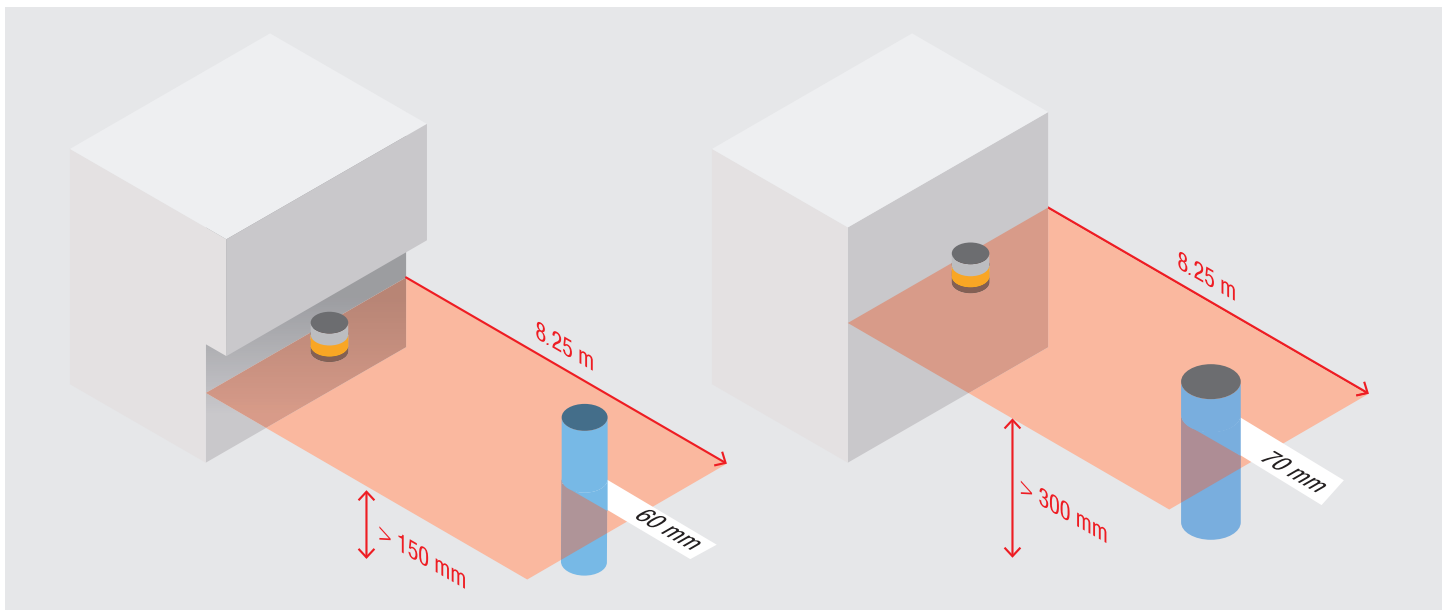

If a laser scanner needs to be installed at a height below 300 mm due to structural conditions acc. to ISO 13855, a higher safety resolution (smaller value) must be selected. For many scanners, this significantly reduces the operating range. But the RSL 400 also impresses in this case: even with mounting heights between 150 mm and 300 mm, it maintains its full operating range of 8.25 meters.

# Access and point of operation guarding

When used for access or point of operation guarding, the RSL 400 is installed vertically. This allows it to identify persons or a hand, for example. The unit impresses with large operating ranges also for these applications.

## Access guarding

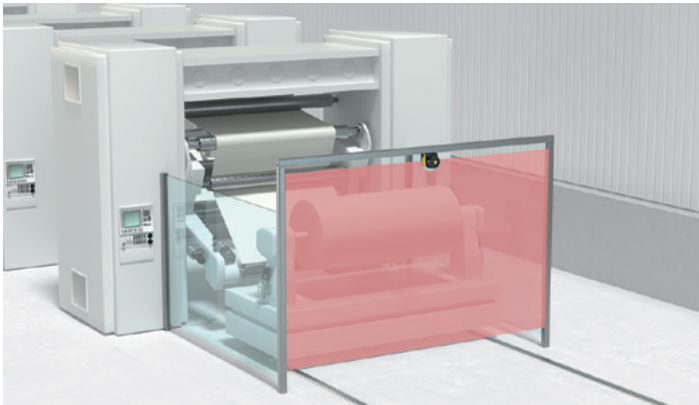

- Large operating range enables monitoring of large entries with a single device
- Monitoring of reference contour for detection of changes in target alignment

## Dual access guarding

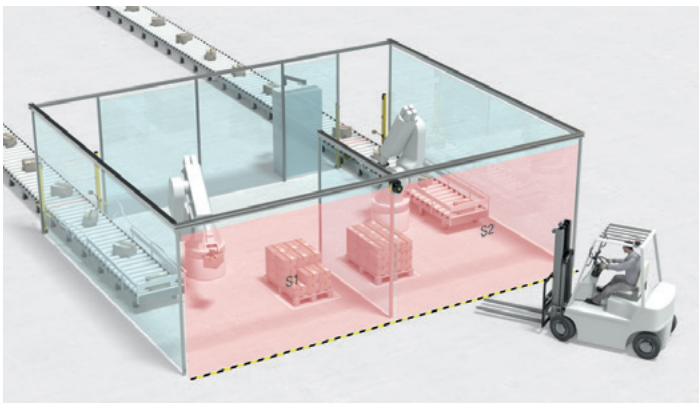

- Complete safeguarding of two stations with only one scanner
- One RSL 400 works like 2 independent scanners within one device due to 2 independent protective functions (S1+S2)
- High operating range enables simultaneous monitoring of both areas

## Point of operation guarding



- Even large openings can be protected with a single device thanks to the 4.5 m operating range at 40 mm resolution (hand detection)
- Monitoring of the reference contour for identification of changes to the required alignment

# Safeguarding and navigation of AGVs

The flexible protective field configurations make the RSL 400 optimally suited to efficiently safeguard various movement and load conditions for automated guided vehicles. Measurement value output for navigation is integrated optionally.

- 100 switchable field pairs or 50 switchable 4-field sets allow for optimum adaptation to the movement and loading situation
- It only takes 2 RSL 400s to get complete all-round protection thanks to the 270° scanning angle
- Safe speed reduction through parallel monitoring of multiple protective fields
- Up to 10 parameter configuration sets enable switching from AGV operating modes without reconfiguration
- Input for chaining the emergency stop circuit facilitates installation and saves inputs at the controller
- Nine configurable I/Os support the integration into the controller, e.g. for status control with/without load
- PROFINET/PROFIsafe model for especially easy integration

## Flexible adaptation of the protective fields

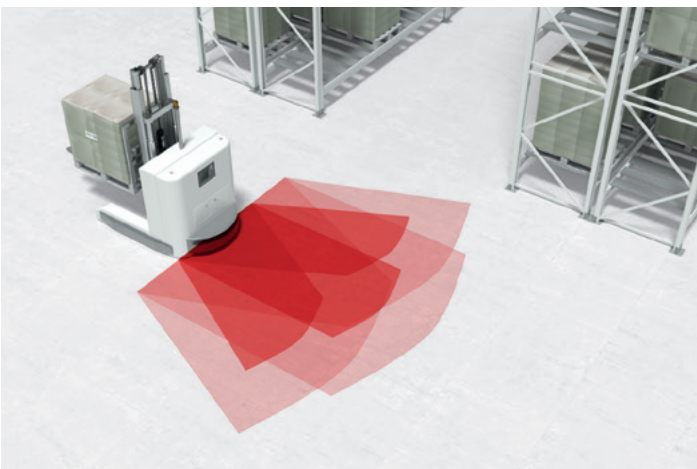

100 switchable field pairs mean optimum support of different movement and load conditions.

## All-around protection with only two devices

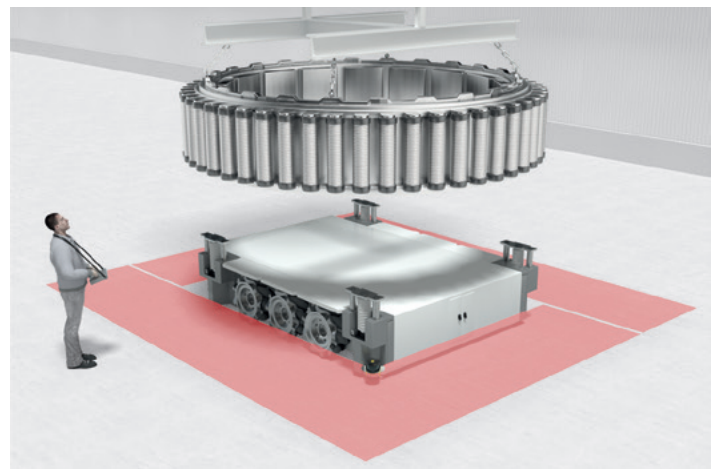

With independent protective functions and 270° scanning angles, even large vehicles can be safeguarded with only two devices.



## Safety function and high-quality measurement data output in one device

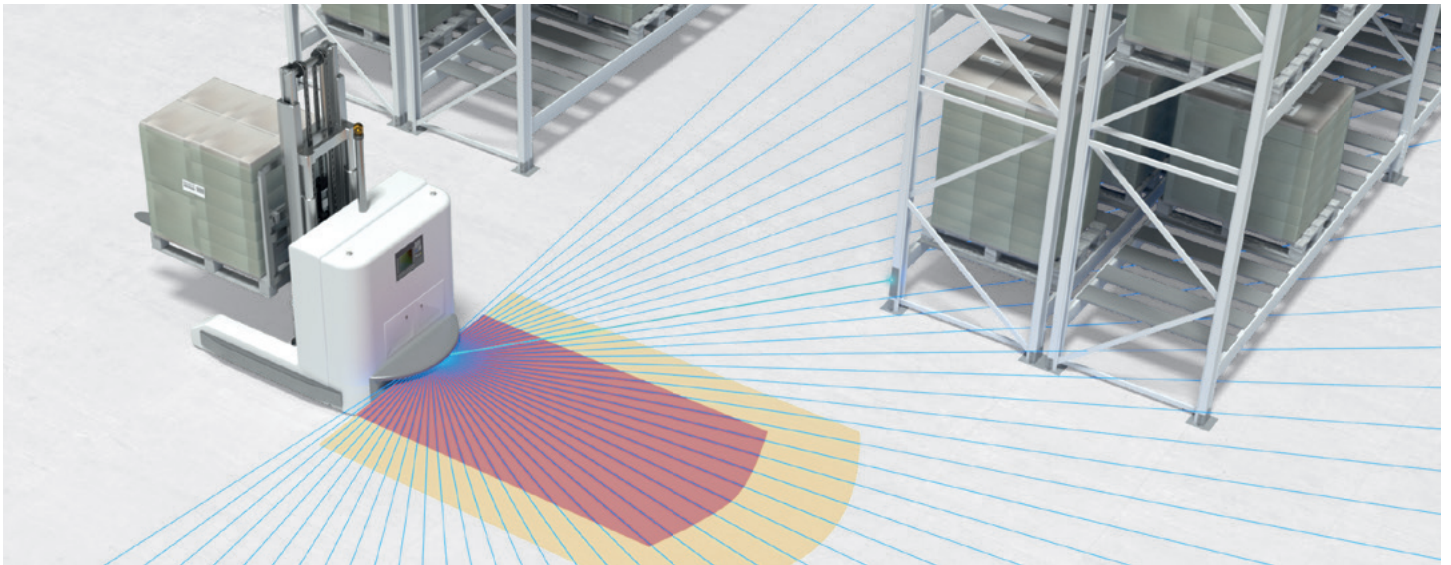

In order to reliably navigate automated guided vehicles (AGV), the quality of the measurement data provided by the laser scanner is critical. Here, the RSL 400 sets new benchmarks. It combines top safety technology with a high-quality measurement value output in a compact device. The high angular resolution of 0.1 degrees makes the RSL 400 particularly suitable for applications in the areas of natural navigation and SLAM (simultaneous localization and mapping).

### Reliable distance values

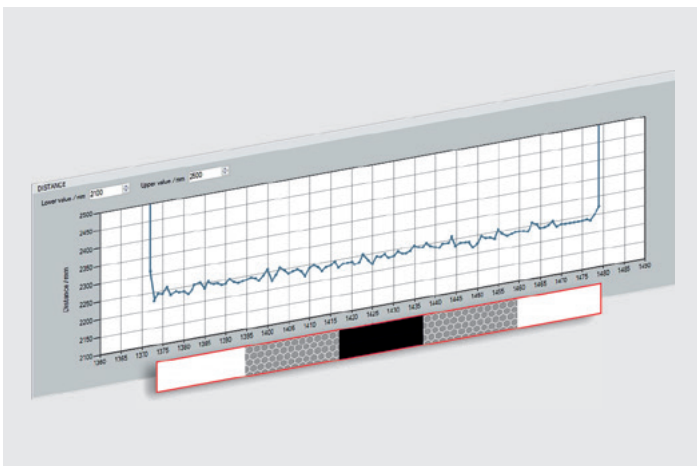

Whether reflector or a black wall – the RSL 400 provides unique distance values that are not influenced by the reflectance of the object. The measurement range can reach up to 50 meters.

### Signal strength values for reflector detection

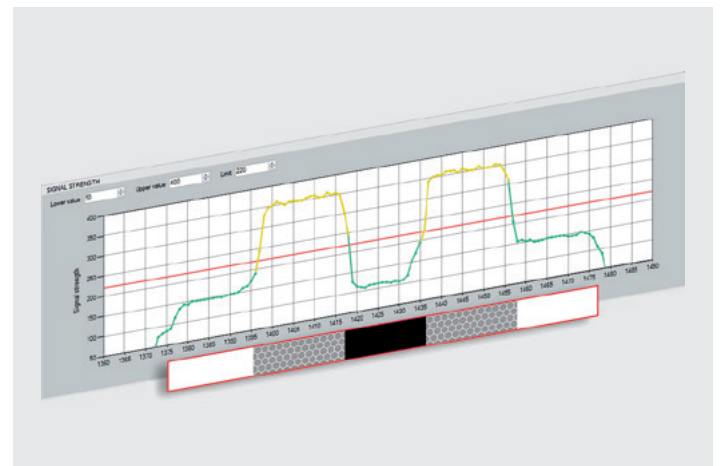

The RSL 400 transmits the received signal strength value with every beam. The navigation software can thus independently and reliably identify reflectors. The signal strength increases significantly when beams hit a reflector.

# Quick and easy to configure

The Sensor Studio configuration and diagnostic software makes it easy to configure and commission the RSL 400. The parameters are depicted in an easy-to-understand and graphical form.



The Sensor Studio configuration software is easy to use and offers the users numerous convenient functions.

- The configuration software guides you through all important settings in only 5 steps
- Quick and easy: first all settings are made – then the entire configuration is loaded onto the RSL 400 with one click
- Single parameters can be individually adjusted at any time
- User interface in nine languages with context-sensitive online help
- Simulation of protective field switchover
- Connection to laser scanner via Ethernet point-to-point, Ethernet network, USB or Bluetooth
- Individual and project view of all RSL 400 in a network

### Intuitive and precise user interface

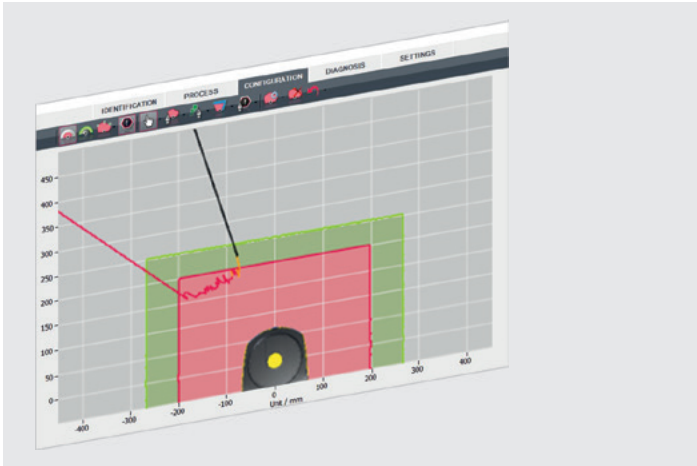

- Simple design and adaptation of the protective fields through different drawing functions
- Import/export for editing corner point coordinates in Excel
- Quick and precise online presentation of the scan contour

### Extensive comfort functions

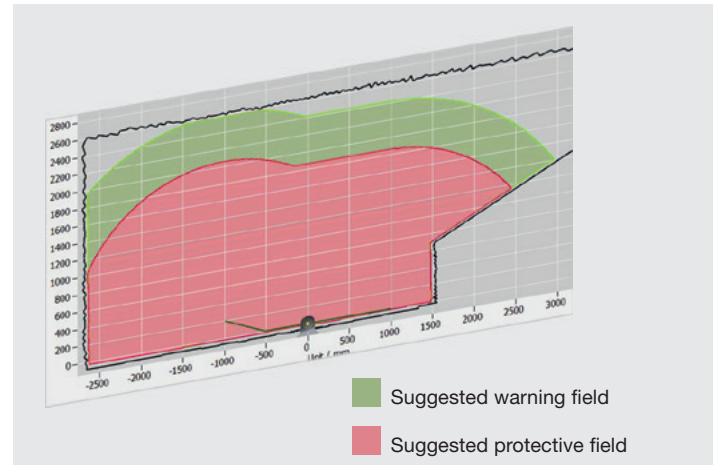

- Automatically generated protective field suggestion with optimal size to the configured danger zone, adapted to boundaries such as walls; only the reaction time of the downstream components needs to be added
- Protective field suggestion can be transferred to the configuration at the push of a button and adapted if required

### Event log with tabular and graphical representation

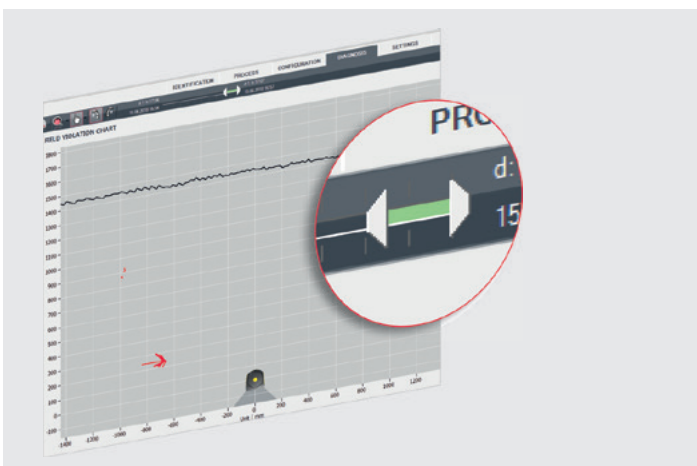

- For local and temporal analysis of events, e.g. whether protective field violations have always occurred at the same location
- Selection of the time range via slider

### Easy documentation with pdf file



- All settings can be saved in a PDF file for documentation
- Protective and warning fields are easy to read from the graphical representation

# Technical data



RSL 410



RSL 420, 425

General	Protective field range	3.0 / 4.5 / 6.25 / 8.25 m	3.0 / 4.5 / 6.25 / 8.25 m
	Scanning angle	270°	270°
	Angular resolution	0.1°	0.1°
	Warning field range (at 10% diffuse reflection)	20 m	20 m
	Resolution, selectable	30 / 40 / 50 / 60 / 70 / 150 mm	30 / 40 / 50 / 60 / 70 / 150 mm
	Response time	≥ 80 ms	≥ 80 ms
	Safety	Type 3, SIL 2, PL d	Type 3, SIL 2, PL d
	Dimensions, incl. connection unit (W x H x D)	140 x 149 x 140 mm	140 x 149 x 140 mm
	Temperature range	0 ... +50°	0 ... +50°
Functions	Technology for robust operation	X	X
	Safety-related switching outputs	1	1
	Number of field pairs (1 protective field + 1 warning field)	1	10
	Number of 4-field sets (1 protective field + 3 warning fields)	1	10
	Number of 4-field sets (2 protective fields + 2 warning fields)	–	–
	Number of independent sensor configurations	1	1
	Internal safe time delay (stop 1)	–	–
	Parking function (protective field switch-off)	–	X
	Restart interlock (RES), configurable	X	X
	Contact monitoring (EDM), selectable	X	X
	Linkage of a safety device, e.g. an emergency stop button	–	X
	Configurable signal outputs	3	4
	UDP data output optimized for AGV navigation, 50 m operating range	–	for RSL 425
Interfaces/connection	Connection unit with integrated configuration memory and flexible cable routing	M12 plug, 8-pin	Cable or connector, 16-pin
	Interfaces for configuration and diagnosis	Ethernet TCP/IP, Bluetooth	Ethernet TCP/IP, USB, Bluetooth
	PROFINET	–	–

All units have an integrated display and electronic spirit level





**RSL 430**

**RSL 440, 445**

**RSL 420P  
PROFINET/PROFIsafe**

**RSL 450P, 455P  
PROFINET/PROFIsafe**

3.0 / 4.5 / 6.25 / 8.25 m	3.0 / 4.5 / 6.25 / 8.25 m	3.0 / 4.5 / 6.25 / 8.25 m	3.0 / 4.5 / 6.25 / 8.25 m
270°	270°	270°	270°
0.1°	0.1°	0.1°	0.1°
20m	20m	20m	20m
30 / 40 / 50 / 60 / 70 / 150 mm	30 / 40 / 50 / 60 / 70 / 150 mm	30 / 40 / 50 / 60 / 70 / 150 mm	30 / 40 / 50 / 60 / 70 / 150 mm
≥ 80 ms	≥ 80 ms	≥ 120 ms	≥ 120 ms
Type 3, SIL 2, PL d	Type 3, SIL 2, PL d	Type 3, SIL 2, PL d	Type 3, SIL 2, PL d
140 × 149 × 140 mm	140 × 149 × 140 mm	140 × 169 × 140 mm	140 × 169 × 140 mm
0 ... +50°	0 ... +50°	0 ... +50°	0 ... +50°
X	X	X	X
2	2	PROFIsafe, 1 protective field	PROFIsafe, 4 simultaneous protective fields
10 + 10	100	10	100*)
10	10	-	-
-	50	-	50*)
2	10	1	10
X	X	-	-
X	X	X	X
X	X	X	X
X	X	-	-
X	X	-	-
9	9	All status information can be called up	All status information can be called up
-	for RSL 445	-	for RSL 455P
Cable or connector, 29-pin	Cable or connector, 29-pin	3x M12 connector for 2-port switch and power supply or 4x M12 connector (L-coded) with additional voltage output   AIDA variant with push-pull connectors, communication via copper or fiber-optic cable	3x M12 connector for 2-port switch and power supply or 4x M12 connector (L-coded) with additional voltage output   AIDA variant with push-pull connectors, communication via copper or fiber-optic cable
Ethernet TCP/IP, USB, Bluetooth	Ethernet TCP/IP, USB, Bluetooth	Ethernet TCP/IP, USB, Bluetooth	Ethernet TCP/IP, USB, Bluetooth
-	-	Conformance class C   Network load class III   PROFINET device according to specification V2.3.4   GSDML according to specification V2.3.2	Conformance class C   Network load class III   PROFINET device according to specification V2.3.4   GSDML according to specification V2.3.2

\*) Warning fields can be evaluated as protective fields

# Suitable products

For fast and simple commissioning of the RSL 400, we offer a large selection of suitable products. This includes special accessories for mounting and connection as well as supplementary products for integration in machines and systems.



## Mounting system

For horizontal and vertical alignment



## Loop guard

To protect the optics cover, in conjunction with the mounting system



## Mounting bracket for floor mounting

For scanning heights of 150 mm, 300 mm and 75–375 mm



## Mounting bracket for corner mounting

For mounting at chamfered corner / non-chamfered corner



## Cleaning set

For cleaning of the optics cover, e.g. for dust, oil and grease



## Connection and interconnection cables

For connection, for configuration / diagnosis



**Programmable safety control**

MSI 400 basic and extension modules with up to 168 I/Os and gateway functions for integrating safety sensors into the machine circuit



**Safety relays**

MSI evaluation units, evaluation units with time delay and contact extensions for integrating safety sensors into the machine circuit



**Power supply**

PSU power supply units and PLM redundancy modules for optimum power supply of the sensors, 1- and 3-phase



**Signaling devices**

For visual and acoustic status visualization, pre-mounted or modular



**Connection and interconnection cables**

with standard M8 and M12 connection



**Passive distribution boxes**

MD distribution box for signal bundling and distribution

# Complete safety solutions

In addition to a wide range of sensors, we also offer safety switches and safety locking devices as well as safe control components. With our Machine Safety Services we are also offering extensive and professional services for all matters related to your machines' life cycle. This means you get sophisticated and reliable solutions for safety at work applications from a single source.

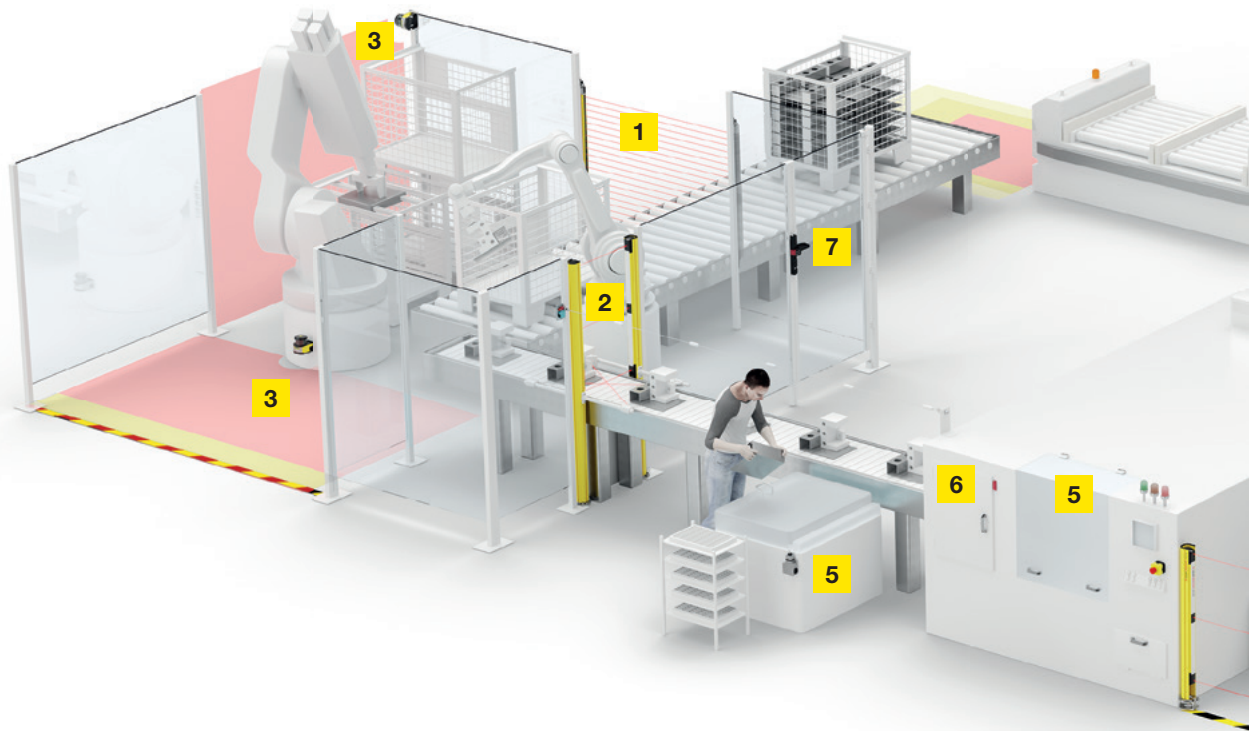

1 Safety light curtains



3 Safety laser scanner



2 Single and multiple light beam safety devices



4 Safety PLCs and relays



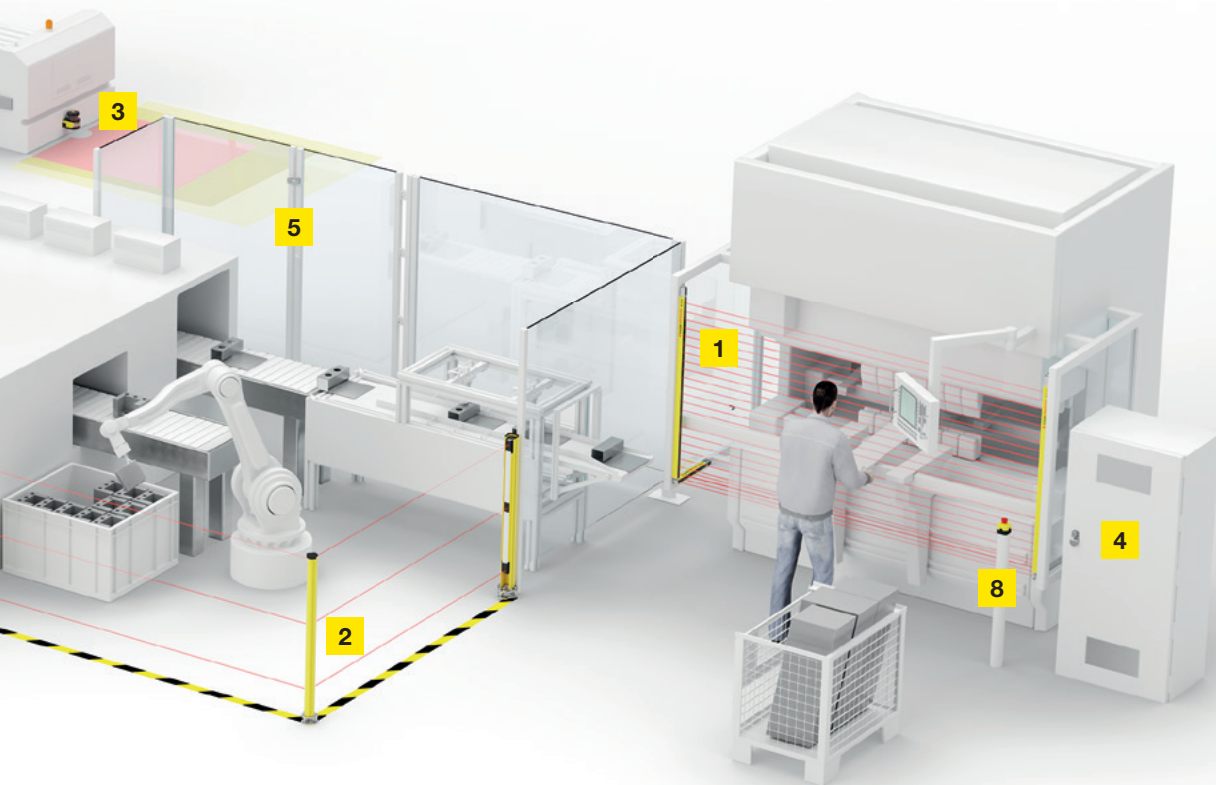

5 Safety switches



7 Safety switches with guard locking



6 Safety proximity sensors



8 Safety command devices

# Our company

## Everything at a glance

In a constantly changing industrial world, we work together with our customers to find the best solution for their sensor applications: innovatively, precisely and efficiently.

### Key figures

<b>Foundation</b>	1963
<b>Company structure</b>	GmbH + Co. KG, wholly family-owned
<b>Executive management</b>	Ulrich Balbach
<b>Headquarters</b>	Owen, Germany
<b>Distribution companies</b>	21
<b>Production locations</b>	5
<b>Technological competence centers</b>	3
<b>Distributors</b>	40
<b>Employees</b>	> 1,200

### Product range

- Switching sensors
- Measuring sensors
- Safety
- Identification
- Data transmission
- Network and connection technology
- Industrial image processing
- Accessories and supplementary products

### Focus industries

- Intralogistics
- Packaging industry
- Machine tools
- Automotive industry
- Laboratory automation



### Leuze electronic GmbH + Co. KG

In der Braike 1  
73277 Owen  
Phone: +49 7021 573-0  
Fax: +49 7021 573-199  
E-mail: [info@leuze.com](mailto:info@leuze.com)  
[www.leuze.com](http://www.leuze.com)









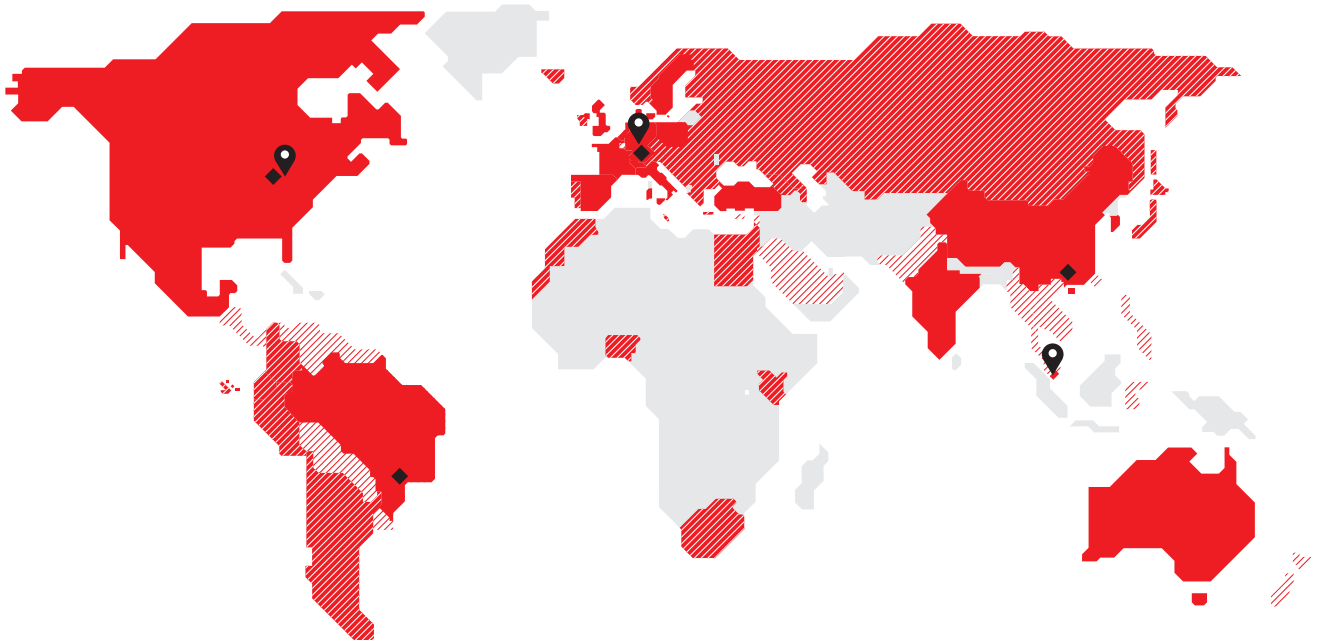

# Our Locations

## At work for you around the world

Your success is our motivation. We therefore place great value on always being personally, quickly, and easily accessible to you. We produce on four continents, allowing us to offer you reliable product availability.



-  Technological competence centers
-  Production locations
-  Subsidiaries
-  Distributor
-  Distribution through neighboring country

### Technological competence centers

Owen, Germany  
 New Hudson/Detroit, USA  
 Singapore

### Production locations

Owen, Germany  
 Unterstadion, Germany  
 New Hudson/Detroit, USA  
 Shenzhen, China  
 São Paulo, Brazil

### Distribution companies

Australia/New Zealand	Italy
Belgium	Mexico
Brazil	Poland
China	Singapore
Denmark/Sweden	South Korea
France	Spain
Germany – headquarters	Switzerland
Germany – distribution company	The Netherlands
Great Britain	Turkey
Hong Kong	USA/Canada
India	

## Our product range at a glance

### Switching sensors

- Optical sensors
- Inductive switches
- Capacitive sensors
- Ultrasonic sensors
- Fiber optic sensors
- Forked sensors
- Light curtains
- Special sensors

### Measuring sensors

- Distance sensors
- Sensors for positioning
- 3D sensors
- Light curtains
- Bar code positioning systems
- Forked sensors

### Safety

- Safety laser scanners
- Safety light curtains
- Single and multiple light beam safety devices
- Safe locking devices, switches and proximity sensors
- Safety PLCs and relays
- Machine safety services

### Identification

- Bar code identification
- 2D-code identification
- RF identification

### Data transmission

- Optical data transmission systems

### Network and connection technology

- Connection technology
- Modular connection units

### Industrial image processing

- Light section sensors
- Smart camera

### Accessories and supplementary products

- Signaling devices
- Mounting systems
- Reflectors

## Your contact with us

### Leuze electronic GmbH + Co. KG

In der Braike 1, 73277 Owen

Phone +49 7021 573-0

Fax +49 7021 573-199

info@leuze.com

[www.leuze.com](http://www.leuze.com)