

Technical data sheet

Polarized retro-reflective photoelectric

Part no.: 50140146

PRK412B/2X-M12

Contents

- Technical data
- Dimensioned drawings
- Electrical connection
- Diagrams
- Operation and display
- Reflectors & reflective tapes
- Part number code
- Notes
- Accessories



Figure can vary



Technical data

Basic data

| | |
|---------------------|----------------------|
| Series | 412B |
| Operating principle | Reflection principle |

Optical data

| | |
|--------------------------|---|
| Operating range | Guaranteed operating range |
| Operating range | 0.02 ... 1.8 m, With reflector TK(S) 100x100 |
| Operating range limit | Typical operating range |
| Operating range limit | 0.02 ... 2.3 m, With reflector TK(S) 100x100 |
| Light source | LED, Red |
| LED light wavelength | 660 nm |
| LED group | Exempt group (in acc. with EN 62471) |
| Transmitted-signal shape | Pulsed |

Electrical data

| | |
|--------------------|------------------------------|
| Protective circuit | Polarity reversal protection |
| | Short circuit protected |

Performance data

| | |
|----------------------|--|
| Supply voltage U_B | 10 ... 36 V, DC, Incl. residual ripple |
| Residual ripple | 0 ... 20 %, From U_B |
| Open-circuit current | 0 ... 15 mA |

Outputs

| | |
|-------------------------------------|------------|
| Number of digital switching outputs | 1 Piece(s) |
|-------------------------------------|------------|

Switching outputs

| | |
|-------------------------|--------|
| Voltage type | DC |
| Switching current, max. | 200 mA |

Switching output 1

| | |
|---------------------|-----------------|
| Switching element | Transistor, NPN |
| Switching principle | Light switching |

Timing

| | |
|---------------------|----------|
| Switching frequency | 1,000 Hz |
| Response time | 0.5 ms |
| Readiness delay | 20 ms |

Connection

Connection 1

| | |
|--------------------|----------------|
| Function | Signal OUT |
| | Voltage supply |
| Type of connection | Connector |
| Thread size | M12 |
| Type | Male |
| Material | Metal |
| No. of pins | 4 -pin |
| Encoding | A-coded |

Mechanical data

| | |
|---------------------|---------------|
| Thread size | M12 x 1 mm |
| Dimension (Ø x L) | 12 mm x 60 mm |
| Housing material | Metal |
| Metal housing | Chromed brass |
| Lens cover material | Glass |
| Net weight | 20 g |
| Housing color | Silver |

Operation and display

| | |
|-----------------|------------|
| Type of display | LED |
| Number of LEDs | 2 Piece(s) |

Environmental data

| | |
|--------------------------------|---------------|
| Ambient temperature, operation | -25 ... 55 °C |
|--------------------------------|---------------|

Certifications

| | |
|----------------------|---------------|
| Degree of protection | IP 67 |
| Protection class | III |
| Certifications | c UL US |
| Standards applied | IEC 60947-5-2 |

Classification

| | |
|-----------------------|----------|
| Customs tariff number | 85365019 |
| eCl@ss 5.1.4 | 27270902 |
| eCl@ss 8.0 | 27270902 |
| eCl@ss 9.0 | 27270902 |
| eCl@ss 10.0 | 27270902 |
| eCl@ss 11.0 | 27270902 |
| ETIM 5.0 | EC002717 |
| ETIM 6.0 | EC002717 |
| ETIM 7.0 | EC002717 |

Dimensioned drawings

All dimensions in millimeters

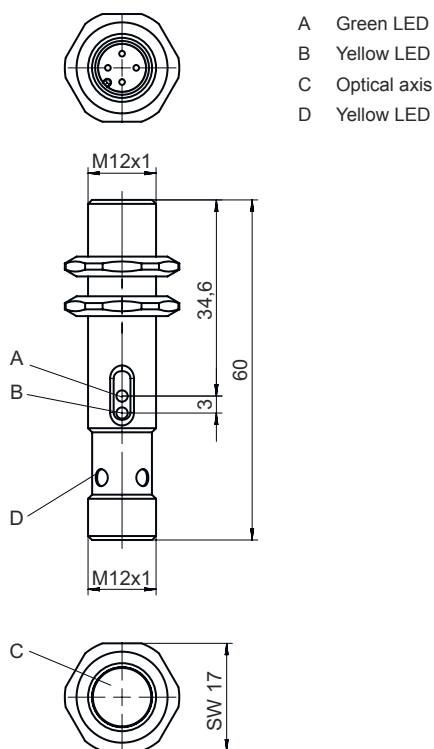

Electrical connection

Connection 1

| | |
|--------------------|----------------|
| Function | Signal OUT |
| | Voltage supply |
| Type of connection | Connector |
| Thread size | M12 |
| Type | Male |
| Material | Metal |
| No. of pins | 4 -pin |
| Encoding | A-coded |

| Pin | Pin assignment |
|-----|----------------|
| 1 | V+ |
| 2 | OUT 1 |
| 3 | GND |
| 4 | n.c. |

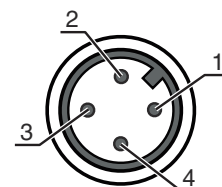

Diagrams

Typ. response behavior

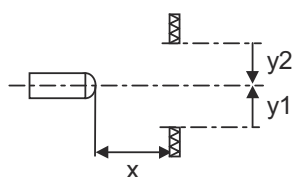
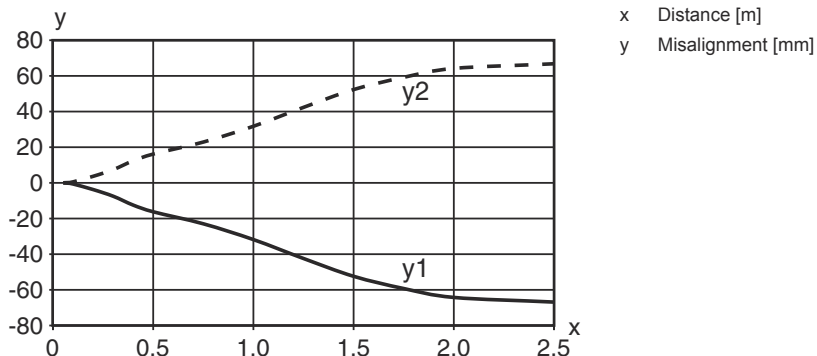

Typ. function reserve

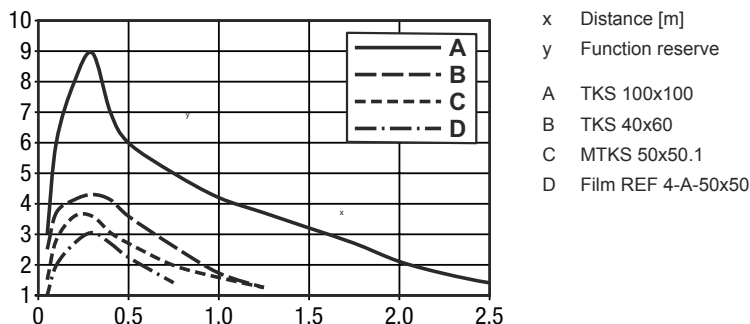

Operation and display

| LED | Display | Meaning |
|-----|--------------------------|---|
| 1 | Green, continuous light | Function reserve |
| 2 | Yellow, continuous light | Switching output/switching state active |

Reflectors & reflective tapes

| | Part no. | Designation | Operating range Operating range | Description |
|--|----------|--------------|------------------------------------|--|
| | 50117583 | MTKS 50x50.1 | 0.015 ... 1 m 0.015 ... 1.3 m | Design: Rectangular Reflective surface: 50 mm x 50 mm Triple reflector size: 1.2 mm Material: Plastic Base material: Plastic Chemical designation of the material: PMMA8N Fastening: Through-hole mounting, Adhesive |

Reflectors & reflective tapes

| | Part no. | Designation | Operating range Operating range | Description |
|---|----------|---------------|------------------------------------|--|
|  | 50108300 | REF 4-A-50x50 | 0.08 ... 0.6 m 0.08 ... 0.8 m | Design: Rectangular Reflective surface: 50 mm x 50 mm Material: Plastic Chemical designation of the material: PMMA Fastening: Self-adhesive |
|  | 50024127 | TK 82.2 | 0.05 ... 1.6 m 0.05 ... 2 m | Design: Round Triple reflector size: 4 mm Reflection surface diameter: 79 mm Material: Plastic Base material: Plastic Chemical designation of the material: PMMA8N Fastening: Through-hole mounting, Adhesive |
|  | 50022816 | TKS 100X100 | 0.02 ... 1.8 m 0.02 ... 2.3 m | Design: Rectangular Reflective surface: 96 mm x 96 mm Triple reflector size: 4 mm Material: Plastic Base material: Plastic Chemical designation of the material: PMMA8N Fastening: Through-hole mounting, Adhesive |
|  | 50081283 | TKS 20X40 | 0.02 ... 0.5 m 0.02 ... 0.65 m | Design: Rectangular Reflective surface: 16 mm x 38 mm Triple reflector size: 2.3 mm Material: Plastic Base material: Plastic Chemical designation of the material: PMMA8N Fastening: Through-hole mounting, Adhesive |
|  | 50023525 | TKS 30X50 | 0.02 ... 0.65 m 0.02 ... 0.85 m | Design: Rectangular Reflective surface: 27 mm x 44 mm Triple reflector size: 3 mm Material: Plastic Base material: Plastic Chemical designation of the material: PMMA8N Fastening: Through-hole mounting, Adhesive |
|  | 50040820 | TKS 40X60 | 0.02 ... 1 m 0.02 ... 1.3 m | Design: Rectangular Reflective surface: 37 mm x 56 mm Triple reflector size: 4 mm Material: Plastic Base material: Plastic Chemical designation of the material: PMMA8N Fastening: Through-hole mounting, Adhesive |

Part number code

Part designation: AAA412BGG.H/ii-K

| | |
|----------------|--|
| AAA412B | Operating principle / construction LS412B: throughbeam photoelectric sensor transmitter LE412B: throughbeam photoelectric sensor receiver ET412B: energetic diffuse reflection sensor PRK412B: retro-reflective photoelectric sensor with polarization filter |
| GG | Light source n/a: LED L2: laser class 2 |
| H | Operating range adjustment 1: 270° potentiometer |

Part number code

| | |
|-----------|---|
| ii | Switching output / function / OUT1OUT2 (OUT1 = pin 2, OUT2 = pin 4) 2: NPN transistor output, light switching N: NPN transistor output, dark switching 4: PNP transistor output, light switching P: PNP transistor output, dark switching D: deactivation input (deactivation with low signal) X: pin not used |
| K | Electrical connection n/a: cable, standard length 2000 mm, 3-wire M12: M12 connector, 4-pin (plug) |

| Note | |
|------|--|
| | ⓘ A list with all available device types can be found on the Leuze website at www.leuze.com . |

Notes

| ⚠ Observe intended use! | |
|-------------------------|---|
| | ⓘ This product is not a safety sensor and is not intended as personnel protection. ⓘ The product may only be put into operation by competent persons. ⓘ Only use the product in accordance with its intended use. |

Accessories

Connection technology - Connection cables



| | Part no. | Designation | Article | Description |
|--|----------|--------------------|------------------|--|
| | 50130652 | KD U-M12-4A-V1-050 | Connection cable | Connection 1: Connector, M12, Axial, Female, A-coded, 4 -pin Connection 2: Open end Shielded: No Cable length: 5,000 mm Sheathing material: PVC |
| | 50130690 | KD U-M12-4W-V1-050 | Connection cable | Connection 1: Connector, M12, Angled, Female, A-coded, 4 -pin Connection 2: Open end Shielded: No Cable length: 5,000 mm Sheathing material: PVC |

Accessories

Mounting technology - Mounting brackets

| | Part no. | Designation | Article | Description |
|--|----------|-------------|------------------|--|
|  | 50113549 | BT D12M.5 | Mounting bracket | Diameter, inner: 12 mm Design of mounting device: Angle, L-shape Fastening, at system: Through-hole mounting Mounting bracket, at device: Screw type Type of mounting device: Rigid Material: Stainless steel |

Standard reflectors

| | Part no. | Designation | Article | Description |
|--|----------|-------------|-----------|--|
|  | 50081283 | TKS 20X40 | Reflector | Design: Rectangular Reflective surface: 16 mm x 38 mm Triple reflector size: 2.3 mm Material: Plastic Base material: Plastic Chemical designation of the material: PMMA8N Fastening: Through-hole mounting, Adhesive |
|  | 50040820 | TKS 40X60 | Reflector | Design: Rectangular Reflective surface: 37 mm x 56 mm Triple reflector size: 4 mm Material: Plastic Base material: Plastic Chemical designation of the material: PMMA8N Fastening: Through-hole mounting, Adhesive |

Reflective tapes for standard applications

| | Part no. | Designation | Article | Description |
|---|----------|---------------|-----------------|---|
|  | 50108300 | REF 4-A-50x50 | Reflective tape | Design: Rectangular Reflective surface: 50 mm x 50 mm Material: Plastic Chemical designation of the material: PMMA Fastening: Self-adhesive |

Note



A list with all available accessories can be found on the Leuze website in the Download tab of the article detailed page.