

LSR 8

Throughbeam photoelectric sensors

en 06-2014/08 50127239



Dimensioned drawing

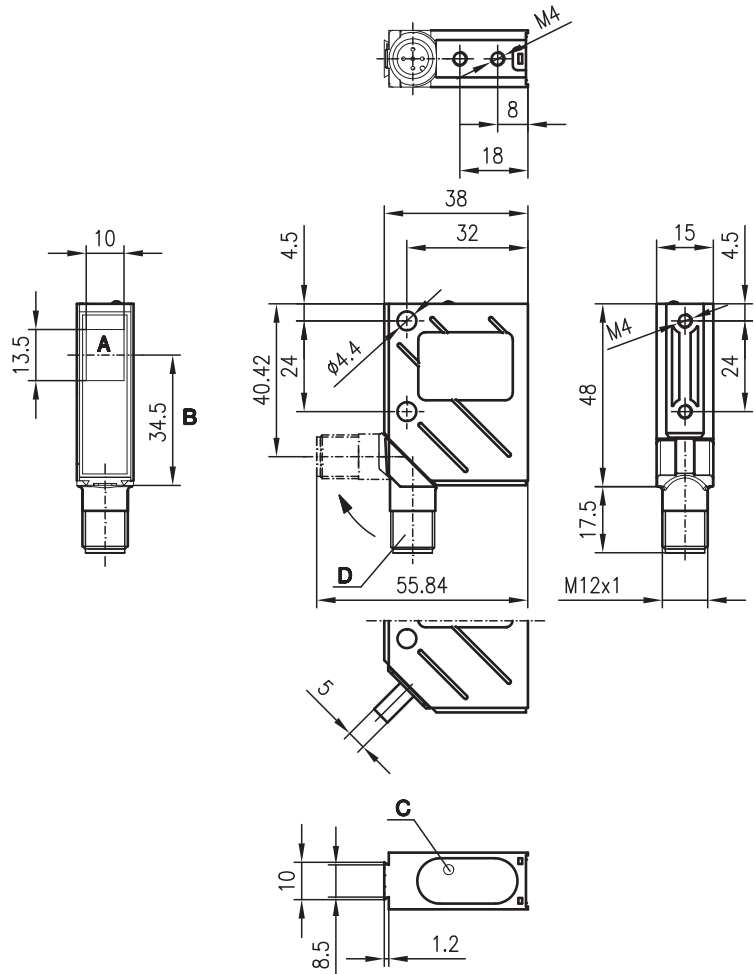

- A Transmitter/receiver
- B Optical axis
- C LED yellow
- D 90° turning connector

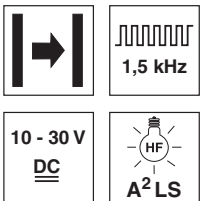

20m

- A²LS - active suppression of extraneous light
- Push-pull switching outputs
- M12 turning connector or cable connection
- Visible red light

Electrical connection

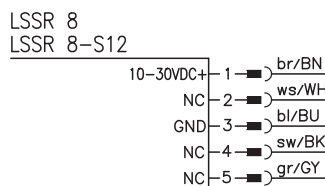
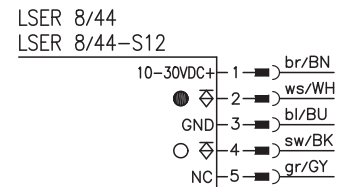
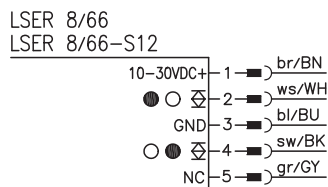

Accessories:

(available separately)

- M12 connectors (KD ...)
- Ready-made cables (K-D ...)
- Mounting systems
- Diaphragms
- Control guard

We reserve the right to make changes • DS\_LSR8Standard\_en\_50127239.fm

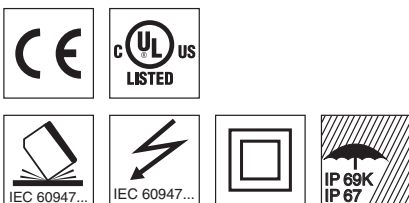

## Specifications

### Optical data

Typ. operating range limit <sup>1)</sup>	20m
Operating range <sup>2)</sup>	12m
Light source	LED (modulated light)
Wavelength	660nm (visible red light)

### Timing

Switching frequency	1500Hz
Response time	0.33ms
Delay before start-up	≤ 100ms

### Electrical data

Operating voltage $U_B$ <sup>3)</sup>	10 ... 30VDC
Residual ripple	≤ 15% of $U_B$
Bias current	≤ 35mA
Switching output/function	.../66 2 push-pull switching outputs <sup>4)</sup> pin 2: PNP dark switching, NPN light switching pin 4: PNP light switching, NPN dark switching
	.../44 2 PNP switching outputs pin 2: dark switching pin 4: light switching
Signal voltage high/low	≥ ( $U_B - 2V$ ) / ≤ 2V
Output current	max. 100mA
Sensitivity	not adjustable

### Indicators

LED yellow, receiver	light path free
LED yellow flashing, receiver	light path free, no performance reserve

### Mechanical data

Housing	metal
Optics cover	glass
Weight (plug/cable)	70g/140g
Connection type	M 12 connector, 5-pin (turning), or cable: 2000mm, 5x0.25mm <sup>2</sup>

### Environmental data

Ambient temp. (operation/storage)	-40°C ... +60°C / -40°C ... +70°C
Protective circuit <sup>5)</sup>	2, 3
VDE safety class <sup>6)</sup>	II, all-insulated
Protection class <sup>7)</sup>	IP 67, IP 69K <sup>8)</sup>
Light source	exempt group (in acc. with EN 62471)
Standards applied	IEC 60947-5-2
Certifications	UL 508, C22.2 No.14-13 <sup>3) 9)</sup>

- 1) Typ. operating range limit: max. attainable range without performance reserve
- 2) Operating range: recommended range with performance reserve
- 3) For UL applications: for use in class 2 circuits according to NEC only
- 4) The push-pull switching outputs must not be connected in parallel
- 5) 2=polarity reversal protection, 3=short-circuit protection for all outputs
- 6) Rating voltage 250VAC
- 7) In stop position of the turning connector (turning connector locked)
- 8) IP 69K test acc. to DIN 40050 part 9 simulated, high pressure cleaning conditions without the use of additives, acids and bases are not part of the test
- 9) These proximity switches shall be used with UL Listed Cable assemblies rated 30V, 0.5A min, in the field installation, or equivalent (categories: CYJV/CYJV7 or PVVA/PVVA7)

## Order guide

	Designation	Part No.
<b>With M12 connector</b>		
Transmitter and receiver	LSR 8/44-S12	
Transmitter	LSSR 8-S12	50036354
Receiver	LSER 8/44-S12	50036356
<b>With 2m cable</b>		
Transmitter and receiver	LSR 8/44	
Transmitter	LSSR 8	50036355
Receiver	LSER 8/44	50036357
<b>With M12 connector</b>		
Transmitter and receiver	LSR 8/66-S12	
Transmitter	LSSR 8-S12	50036354
Receiver	LSER 8/66-S12	50036569
<b>With 2m cable</b>		
Transmitter and receiver	LSR 8/66	
Transmitter	LSSR 8	50036355
Receiver	LSER 8/66	50036570

## Tables

without diaphragm:

0	12	20
---	----	----

with pin diaphragm in front of receiver<sup>1)</sup>:

0	1.8	2
---	-----	---

with pin diaphragm in front of transmitter and receiver<sup>1)</sup>:

0	0.5	0.6
---	-----	-----

with slit diaphragm in front of receiver<sup>1)</sup>:

0	4.5	5
---	-----	---

with slit diaphragm in front of transmitter and receiver<sup>1)</sup>:

0	2.5	3
---	-----	---

- Operating range [m]
- Typ. operating range limit [m]

1) see remarks

## Diagrams

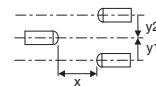
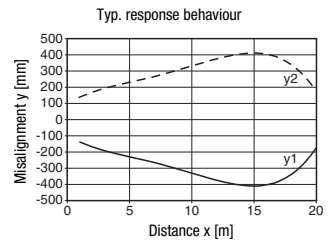

## Remarks

### Operate in accordance with intended use!

- This product is not a safety sensor and is not intended as personnel protection.
- The product may only be put into operation by competent persons.
- Only use the product in accordance with the intended use.

- Smallest object for the complete operating range with
  - pin diaphragm:  $\varnothing=0.7\text{ mm}$ ,
  - slit diaphragm:  $\varnothing=1.5\text{ mm}$