

SMART
SENSOR
BUSINESS

LSIS 4xxi Smart Camera

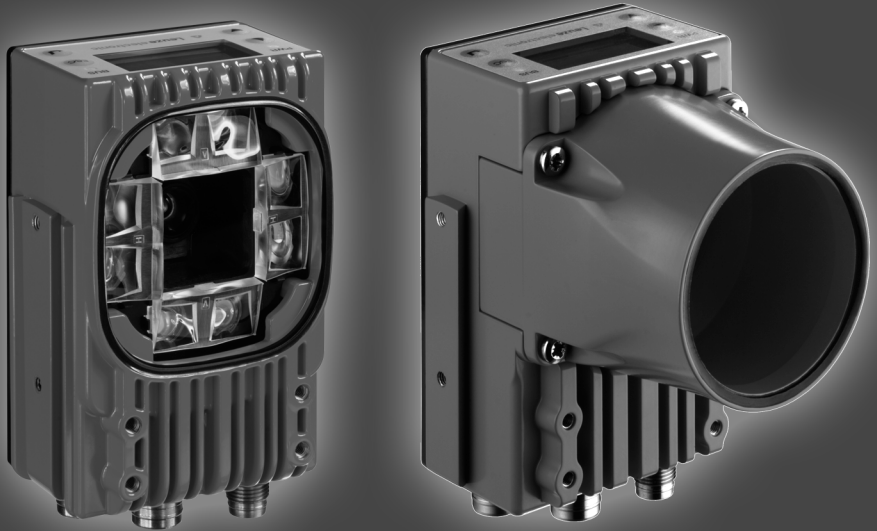

EN 06-2018/01 50110628
We reserve the right to
make technical changes

© 2018

Leuze electronic GmbH + Co. KG

In der Braike 1

D-73277 Owen / Germany

Phone: +49 7021 573-0

Fax: +49 7021 573-199

<http://www.leuze.com>

info@leuze.com

The main menus

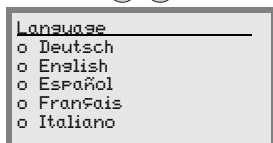
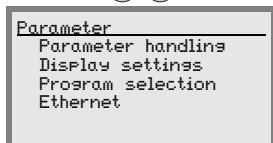
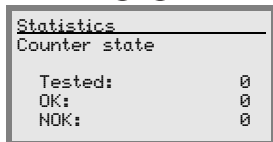
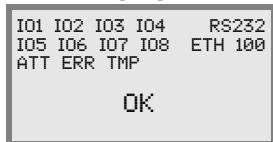

Device information - main menu

Information about

- Device type
- Software version
- Hardware version
- Serial number

Status displays - main menu

- Status displays of the switching inputs/ outputs
 - Display of warnings and errors
 - Status information for the device interfaces
 - Optional: check program-specific display
- See "Indicators in the display" on page 40.

Statistics - main menu

Statistics data for the smart camera.
See "Statistics" on page 44.

Parameter - main menu

Editing Ethernet settings and selecting check programs stored on the LSIS 4xx*i*.
See "Parameter menu" on page 45.

Language selection - main menu

Selection of the display language.
See "Language selection menu" on page 46.

Service - main menu





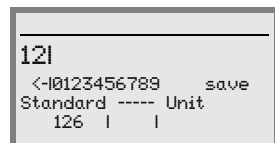

Camera diagnosis and status messages.
See "Service menu" on page 46.

Device buttons:

-  Navigate upward/laterally
-  Navigate downward/laterally
-  **ESCAPE** leave
-  **ENTER** confirm

Input of values



-  +  Delete digit
-  +  +  Enter digit
- save +  Save input

PWR

 **PWR LED**

- | | |
|--------------------------|---------------------------------|
| Off | Device OFF |
| Flashes green | Device ok, initialization phase |
| Green, continuous light | Device OK |
| Orange, continuous light | Service mode |
| Flashes red | Device ok, warning set |
| Red, continuous light | Device error |

BUS

 **BUS LED**

- | | |
|-------------------------|---------------------|
| Off | No supply voltage |
| Flashes green | Bus initialization |
| Green, continuous light | Operation OK |
| Flashes red | Communication error |

1	General information.....	6
1.1	Explanation of symbols.....	6
1.2	Declaration of conformity	6
2	Safety	7
2.1	Intended use.....	7
2.2	Foreseeable misuse.....	8
2.3	Competent persons	9
2.4	Exemption of liability.....	9
3	Device description	10
3.1	About smart cameras of the LSIS 4xx <i>i</i> series	10
3.2	Characteristics of the smart cameras of the LSIS 4xx <i>i</i> series.....	14
3.3	Device construction.....	16
3.4	Stand-alone connection	17
4	Installation and mounting	18
4.1	Storage, transportation	18
4.2	Mounting the LSIS 4xx <i>i</i>	19
4.2.1	Fastening with M4 x 6 screws.....	19
4.2.2	Mounting devices.....	20
4.3	Device arrangement.....	22
4.3.1	Selecting a mounting location.....	22
4.3.2	Determining the camera distance	22
4.4	Lens replacement LSIS 4xx <i>i</i> - C-mount devices	25
4.5	Exchange / Mounting of optical filters	26
4.5.1	Mounting of optional polarization filter on standard device.....	26
4.5.2	Filter exchange for C-mount device.....	27
4.6	Cleaning.....	28
5	Electrical connection.....	29
5.1	Safety notices for the electrical connection.....	30
5.2	Electrical connection of the LSIS 4x2 <i>i</i>	31
5.2.1	PWR - voltage supply and switching inputs/outputs 1 to 4.....	32
5.2.2	BUS OUT - RS 232 and switching inputs/outputs 5 to 8	34
5.2.3	SERVICE - Ethernet host/configuration interface.....	35

6	Commissioning and configuration.....	36
6.1	Establishing a connection between PC and LSIS 4xx<i>i</i>.....	36
6.1.1	Starting the device	36
6.1.2	Establishing an Ethernet connection	36
6.1.3	Configuring the LSIS 4xx <i>i</i> from a laptop without a network.....	37
6.1.4	Integrating the LSIS 4xx <i>i</i> in an existing network.....	38
6.2	Configuring via webConfig	39
7	Display and control panel	41
7.1	Structure of the control panel.....	41
7.2	Status display and operation	41
7.2.1	Indicators in the display	41
7.2.2	Control buttons	42
7.2.3	LED status displays	43
7.3	Menu description	44
7.3.1	The main menus	44
7.3.2	Status displays.....	45
7.3.3	Statistics	45
7.3.4	Parameter menu	46
7.3.5	Language selection menu.....	47
7.3.6	Service menu.....	47
7.4	Operation	48
8	Diagnostics and troubleshooting.....	51
8.1	Error signaling via LED	51
9	Type overview and accessories	52
9.1	Type overview LSIS 4xx<i>i</i> - standard devices.....	52
9.2	Type overview LSIS 4xx<i>i</i> - C-mount devices and lenses.....	53
9.3	Accessories	53
9.4	Accessory ready-made cables for voltage supply.....	54
9.4.1	Contact assignment of PWR connection cable.....	54
9.4.2	Order codes of the cables for voltage supply	54
9.5	Accessory ready-made cables for bus connection	55
9.5.1	Contact assignment BUS OUT connection cable.....	55
9.5.2	Order codes BUS OUT connection cables	55

9.6	Accessories for the host/service interface.....	56
9.6.1	Ready-made cables with M12 plug/open cable end.....	56
9.6.2	Ready-made cables with M12 plug/RJ-45 plug.....	57
9.6.3	Ready-made cables with M12 plug/M12 plug.....	58
9.6.4	Connector.....	58
10	Maintenance.....	59
10.1	General maintenance information.....	59
10.2	Repairs, servicing.....	59
10.3	Disassembling, packing, disposing.....	59
11	Specifications.....	60
11.1	Specifications of standard devices with integrated lens.....	60
11.2	Specifications of devices for C-mount interchangeable lenses.....	61
11.3	Dimensioned drawings.....	62

Figure 3.1:	Application example: presence monitoring	11
Figure 3.2:	Application example: completeness monitoring	11
Figure 3.3:	Application example: orientation detection	12
Figure 3.4:	Application example: code verification	12
Figure 3.5:	Application example: dot-peened Data Matrix code	13
Figure 3.6:	Application example: label positioning and label identification	13
Figure 3.7:	Application example - measurement of radii and roundness	14
Figure 3.8:	Detecting objects with webConfig	15
Figure 3.9:	Standard device construction	16
Figure 3.10:	Device construction variants for C-mount interchangeable lens	16
Figure 3.11:	Stand-alone connection	17
Figure 4.1:	Device name plate LSIS 4xx <i>i</i>	18
Figure 4.2:	Fastening options using M4 threaded holes	19
Figure 4.3:	BT 56 mounting device	20
Figure 4.4:	Mounting examples of LSIS 4xx <i>i</i> with BT 56	21
Figure 4.5:	BT 59 mounting device	21
Figure 4.6:	Camera distance / image field - standard devices	23
Figure 4.7:	Camera distance / image field - device models for C-mount interchangeable lenses	24
Figure 4.8:	Lens replacement for C-mount devices	25
Figure 4.9:	Optional polarization filter for standard devices	26
Figure 4.10:	Filter replacement for C-mount devices	27
Figure 5.1:	Location of the electrical connections	29
Figure 5.2:	Connections of the LSIS 4x2 <i>i</i>	31
Table 5.1:	Pin assignments - PWR	32
Figure 5.3:	Connection diagram of IO1 through IO8 configured as switching inputs	33
Figure 5.4:	Connection diagram of IO1 through IO8 configured as switching outputs	33
Table 5.2:	Pin assignment BUS OUT	34
Figure 5.5:	RS 232 pin assignments	34
Table 5.3:	SERVICE pin assignments	35
Figure 5.6:	Cable assignments - SERVICE on RJ-45	35
Table 6.1:	Address assignment in the Ethernet	37
Figure 6.1:	Connecting the LSIS 4xx <i>i</i> to the PC	38
Figure 6.2:	webConfig start page	39
Figure 7.1:	Structure of the control panel	41
Table 7.1:	Parameter handling submenu	46
Table 7.2:	Program selection submenu	46
Table 7.3:	Ethernet submenu	47
Table 8.1:	General causes of errors	51
Table 9.1:	Type overview LSIS 4xx <i>i</i> - standard devices	52
Table 9.2:	Type overview LSIS 4xx <i>i</i> - C-mount devices	53
Table 9.3:	Type overview LSIS 4xx <i>i</i> - C-mount lenses	53
Table 9.4:	Accessories for the LSIS 4xx <i>i</i>	53
Table 9.5:	Pin assignments KD S-M12-8A-P1-	54
Table 9.6:	PWR cables for the LSIS 4xx <i>i</i>	54
Table 9.7:	Pin assignments KS S-M12-8A-P1-	55
Table 9.8:	BUS OUT cables for the LSIS 4xx <i>i</i>	55
Table 9.9:	Ethernet connection cables featuring M12 plug/open cable end	56

Table 9.10:	Ethernet connection cables M12 connector/RJ-45.....	57
Table 9.11:	Ethernet connection cables featuring M12 plug/M12 plug	58
Table 9.12:	Connectors for the LSIS 4xx <i>i</i>	58
Table 11.1:	Specifications of the LSIS 4x2 <i>i</i> M4x-...1(-01) smart camera	60
Table 11.2:	Specifications of smart camera LSIS 4x2 <i>i</i> M49-X9.....	61
Figure 11.1:	Dimensioned drawing of the LSIS 4xx <i>i</i> smart camera - standard devices.....	62
Figure 11.2:	Dimensioned drawing of the LSIS 4xx <i>i</i> smart camera - devices for C-mount lenses	63

1 General information

1.1 Explanation of symbols

The symbols used in this technical description are explained below.



Attention!

This symbol precedes text messages which must strictly be observed. Failure to comply with this information results in injuries to persons or damage to the equipment.



Notice!

This symbol indicates text passages containing important information.

1.2 Declaration of conformity

The smart cameras of the LSIS 4xx*i* series have been developed and manufactured in accordance with the applicable European standards and directives.



Notice!

You can request a copy of the Declaration of Conformity for the device from the manufacturer.

The manufacturer of the product, Leuze electronic GmbH & Co KG in D-73277 Owen, possesses a certified quality assurance system in accordance with ISO 9001.



2 Safety

This sensor was developed, manufactured and tested in line with the applicable safety standards. It corresponds to the state of the art.

2.1 Intended use

Smart cameras of the LSIS 4xx*i* series are designed for general applications in industrial image processing, e.g. in automation technology or quality assurance.

Areas of application

Smart cameras of the LSIS 4xx*i* series are designed for the following area of application:

- Presence monitoring
- Completeness monitoring
- Omnidirectional 1D and 2D (multiple) code reading
- Code qualification acc. to ISO/IEC
- Type detection
- Position detection
- Orientation detection
- Measuring tasks



CAUTION

Observe intended use!

The protection of personnel and the device cannot be guaranteed if the device is operated in a manner not complying with its intended use.

- ⚠ Only operate the device in accordance with its intended use.
- ⚠ Leuze electronic GmbH + Co. KG is not liable for damages caused by improper use.
- ⚠ Read the supplement and these operating instructions for the device before commissioning the device. Knowledge of these documents is required in order to use the equipment for its intended purpose.

<p>NOTE</p> <p>Smart cameras from the LSIS 4xxi family correspond to the following classification regarding integrated illumination:</p> <p>☞ Illumination white / RGBW: risk group 1 in acc. with EN 62471:2008.</p> <p>☞ Illumination infrared: risk group 0 (exempt group) in acc. with EN 62471:2008.</p> <p>Illuminations of the free groups do not pose any photobiological danger.</p> <p>Illuminations in risk group 1 are safe under most conditions of use, except in the case of very long exposure including possible eye exposure.</p> <p>☞ To completely prevent indirect dangers, such as glare, do not look directly into the light.</p>

<p>NOTE</p> <p>Comply with conditions and regulations!</p> <p>☞ Observe the locally applicable legal regulations and the rules of the employer's liability insurance association.</p>

2.2 Foreseeable misuse

Any use other than that defined under "Intended use" or which goes beyond that use is considered improper use.

In particular, use of the device is not permitted in the following cases:

- in rooms with explosive atmospheres
- as stand-alone safety component in accordance with the machinery directive ^{1.)}
- for medical purposes
- in outdoor areas

<p>NOTE</p> <p>Do not modify or otherwise interfere with the device!</p> <p>☞ Do not carry out modifications or otherwise interfere with the device. The device must not be tampered with and must not be changed in any way.</p> <p>☞ The device must not be opened. There are no user-serviceable parts inside.</p> <p>☞ Repairs must only be performed by Leuze electronic GmbH + Co. KG.</p>

1.) Use as a safety-related component within a safety function is not permissible.

2.3 Competent persons

Connection, mounting, commissioning and adjustment of the device must only be carried out by competent persons.

Prerequisites for competent persons:

- They have a suitable technical education.
- They are familiar with the rules and regulations for occupational safety and safety at work.
- They are familiar with the original operating instructions of the device.
- They have been instructed by the responsible person on the mounting and operation of the device.

Certified electricians

Electrical work must be carried out by a certified electrician.

Due to their technical training, knowledge and experience as well as their familiarity with relevant standards and regulations, certified electricians are able to perform work on electrical systems and independently detect possible dangers.

In Germany, certified electricians must fulfill the requirements of DGUV regulation 3 (e.g. electrician foreman). In other countries, there are respective regulations that must be observed.

2.4 Exemption of liability

Leuze electronic GmbH + Co. KG is not liable in the following cases:

- The device is not being used properly.
- Reasonably foreseeable misuse is not taken into account.
- Mounting and electrical connection are not properly performed.
- Changes (e.g., constructional) are made to the device.

3 Device description

3.1 About smart cameras of the LSIS 4xx*i* series

Smart cameras of the LSIS 4xx*i* series perform numerous tasks in industrial image processing such as:

- Presence monitoring
- Completeness monitoring
- Omnidirectional 1D and 2D (multiple) code reading
- Code qualification acc. to ISO/IEC
- Type detection
- Position detection
- Orientation detection
- Measuring tasks

The many possible configurations of the device allow it to be adapted to a multitude of detection tasks.

Functions overview

There are 3 basic device types available with various performance characteristics:

Features	LSIS 412 <i>i</i> ...	LSIS 422 <i>i</i> ...	LSIS 462 <i>i</i> ...
BLOB analysis			
Presence / completeness	X		X
Type detection	X		X
Position / angle	X		X
Repositioning (X, Y, 360°)	X		X
Up to 99 objects per tool	X		X
Code reading			
1D-codes (Code 39, Code 128, 2/5 interleaved, Codabar, EAN/UPC, Pharmacode)		X	X
2D-codes (Data Matrix code ECC 200)		X	X
Omnidirectional reading	X		X
Multiple code reading (max. 99)	X		X
Reference code comparison		X	X
Code qualification acc. to ISO/IEC 15416, 15415, 16022		X	X
Display of the read result in the device display		X	X
Measuring tool			
Measurement (point, lines, distance, circle)			X
Determination of edge number and position (X, Y)			X
Measurement of X/Y coordinates			X
Vernier caliper function			X

Application examples: blob analysis

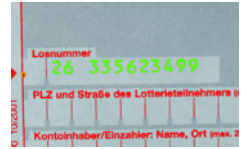

Figure 3.1: Application example: presence monitoring

Figure 3.1 shows the presence monitoring of printed lottery numbers with an LSIS 412*i* during the printing of lottery tickets.

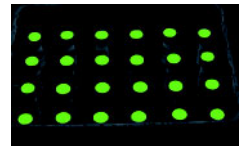

Figure 3.2: Application example: completeness monitoring

Figure 3.2 shows full-crate monitoring with an LSIS 412*i*.

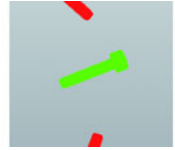
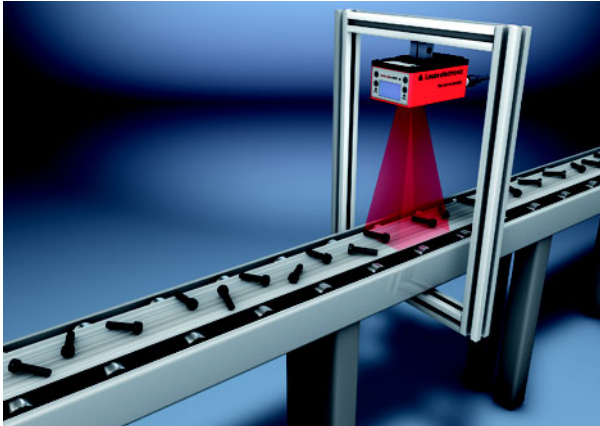

Figure 3.3: Application example: orientation detection

Figure 3.3 shows the detection of position and angle of individual parts with an **LSIS 412*i***.

Application examples: code reading



Figure 3.4: Application example: code verification

Figure 3.4 shows the reading of a 1D code (Pharmacode) on pharmaceutical packages and an optional verification of uniformity using a stored reference code with an **LSIS 422*i***.

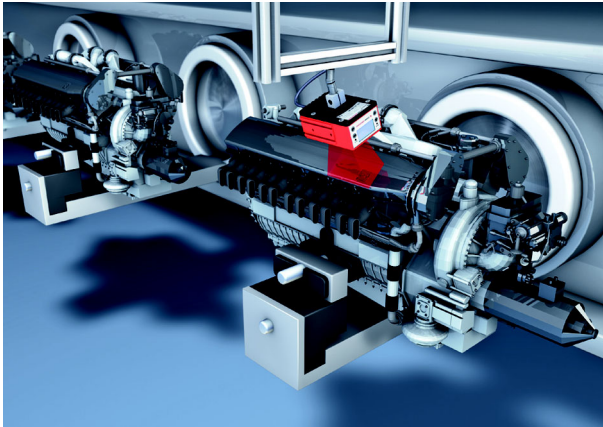

Figure 3.5: Application example: dot-peened Data Matrix code

Figure 3.5 shows the reading of dot-peened 2D codes on engine blocks with an LSIS 422*i*.



Figure 3.6: Application example: label positioning and label identification

Figure 3.6 shows the presence inspection for the correct label and the reading of the 1D code with an LSIS 462*i*.

Measuring tool application example

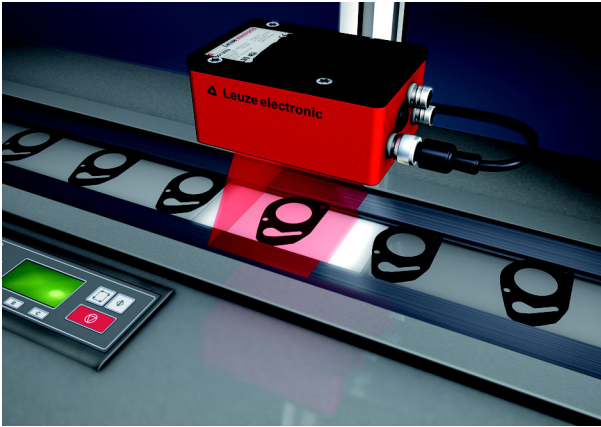

Figure 3.7: Application example - measurement of radii and roundness

Figure 3.7 shows the measurement of radii and roundness on a component by a LSIS 462*i*.

3.2 Characteristics of the smart cameras of the LSIS 4xx*i* series

Performance features:

- Diverse mounting options with dovetail technology or mounting threads on the front, rear and narrow side of the device.
- Device models for C-mount interchangeable lenses.
- Motor-driven focus adjustment with automatic readjustment on change of check program.
- Integrated illumination with special optics for homogeneous illumination of the rectangular field of view, divided into 4 quadrants that can be switched on and off separately.
- Intuitive, backlit, multi-language display with user-friendly menu navigation.
- Real-time clock (time with date) with built-in backup battery.
- Adjustment of all device parameters with a web browser. No additional software needs to be installed.
- M12 connections with Ultra-Lock™ technology.
- Eight freely programmable switching inputs/outputs for the activation or signaling of states.
- Heavy-duty housing of protection class IP 65, IP 67.



Notice!

Information on technical data and characteristics can be found in chapter 11.

General information

Basic operation of the LSIS 4xx*i* is via a multi-language control panel (display with buttons). The control panel can be used to view statistics and status messages. Two LEDs provide additional optical information on the current operating state of the device.

The eight freely configurable switching inputs/outputs "SWIO 1 ... SWIO 8" can be assigned various functions and control e.g. activation of the LSIS 4xx*i* or communication with external devices, such as a PLC.

The LSIS 4xx*i* can be operated and configured by means of the integrated webConfig via the Ethernet service interface.

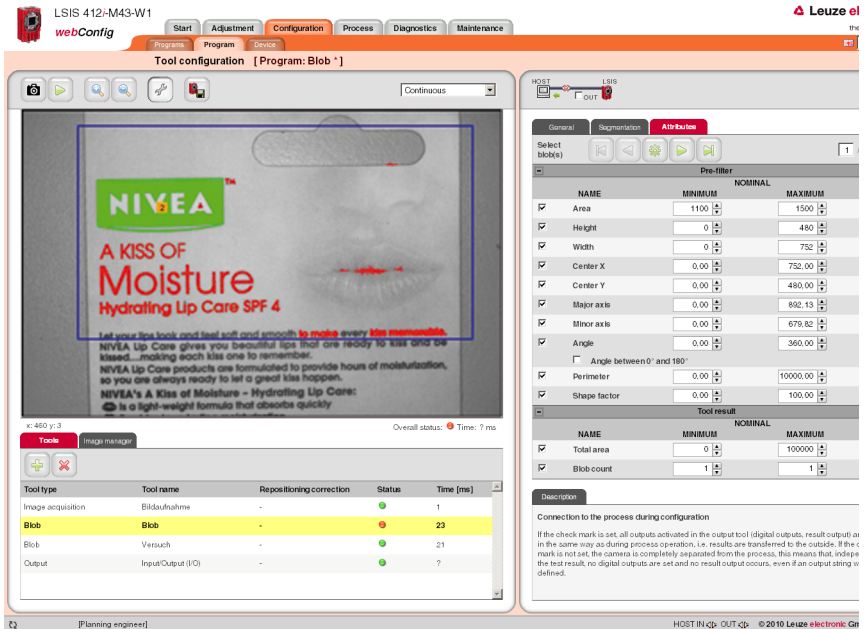

Figure 3.8: Detecting objects with webConfig

With webConfig, individual check programs can be set up for detecting objects. The object being searched for is displayed in green in Figure 3.8.

3.3 Device construction

Standard device

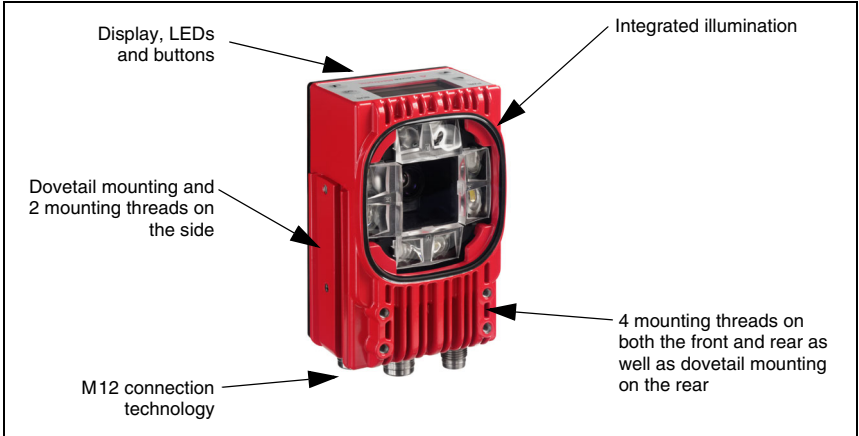

Figure 3.9: Standard device construction

Device models for C-mount interchangeable lenses

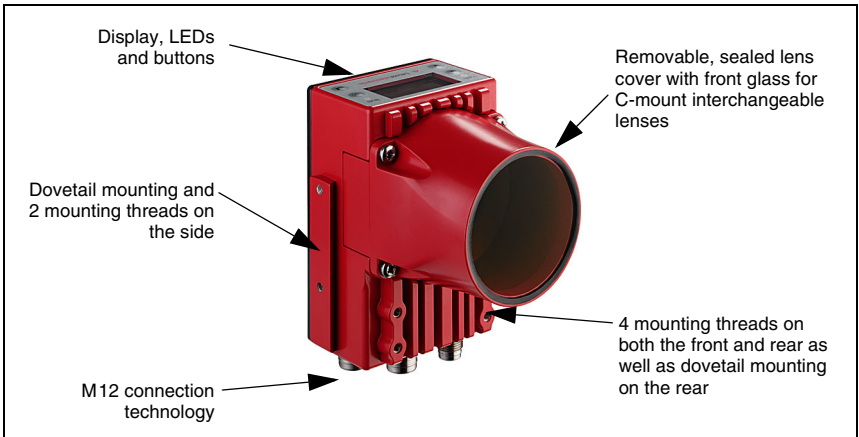

Figure 3.10: Device construction variants for C-mount interchangeable lens

3.4 Stand-alone connection

The smart cameras of the LSIS 4xx*i* series can be operated as individual "stand alone" devices. The LSIS 4xx*i* features multiple M12 connectors / sockets for the electrical connection of the supply voltage, the interfaces and the switching inputs and outputs.

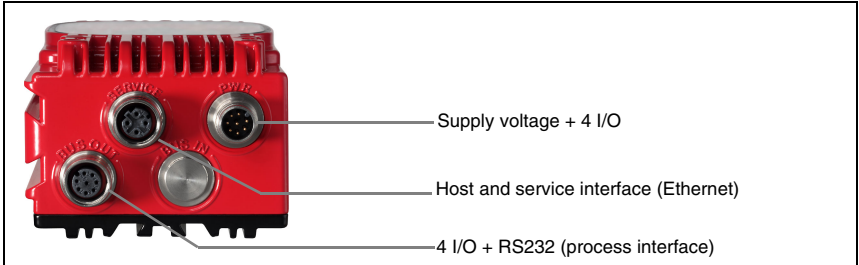

Figure 3.11: Stand-alone connection

The host/service interface is used to configure the LSIS 4xx*i*. Configuration is performed via the integrated webConfig, which can be accessed via a PC with a current browser.

The freely configurable switching inputs and outputs are used for process control.

The LSIS 4xx*i* can exchange data with the process control via the RS 232 or Ethernet process interface. The protocol for the RS232 interface can be configured for the specific application in webConfig.

No configurable framing protocol is available for the Ethernet process interface. A pure ASCII protocol is used via Ethernet.

4 Installation and mounting

4.1 Storage, transportation



Attention!

When transporting or storing, package the device so that it is protected against collision and humidity. Optimal protection is achieved when using the original packaging. Heed the required environmental conditions specified in the technical data.

Unpacking

- ↳ Check the packaging for any damage. If damage is found, notify the post office or shipping agent as well as the supplier.
- ↳ Check the delivery contents using your order and the delivery papers:
 - Delivered quantity
 - Device type and model as indicated on the nameplate
 - Package insert

The name plate provides information as to what LSIS type your device is. For specific information, please refer to chapter 9.

Name plates of the smart cameras of the LSIS 4xx*i* series

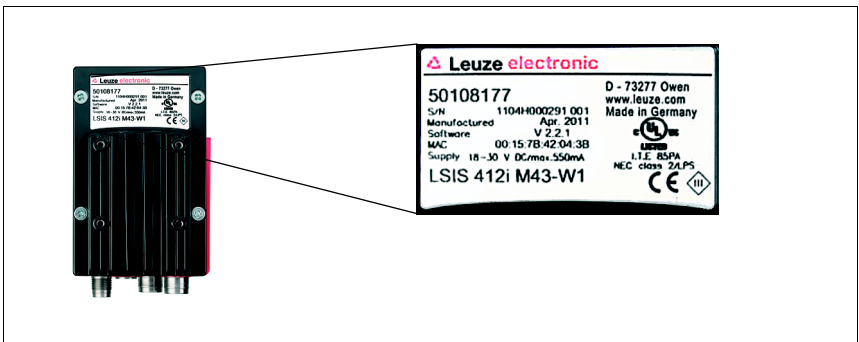

Figure 4.1: Device name plate LSIS 4xx*i*

- ↳ Save the original packaging for later storage or shipping.

If you have any questions concerning your shipment, please contact your supplier or your local Leuze electronic sales office.

- ↳ Observe the applicable local regulations when disposing of the packaging materials.

4.2 Mounting the LSIS 4xx*i*

The LSIS 4xx*i* smart cameras can be mounted in various ways:

- By means of four M4 screws on the rear of the device, four M4 screws on the front of the device or two M4 screws on the narrow side of the device.
- By means of a BT 56/BT 59 mounting device on the two fastening grooves on the narrow side or rear of the device.

4.2.1 Fastening with M4 x 6 screws

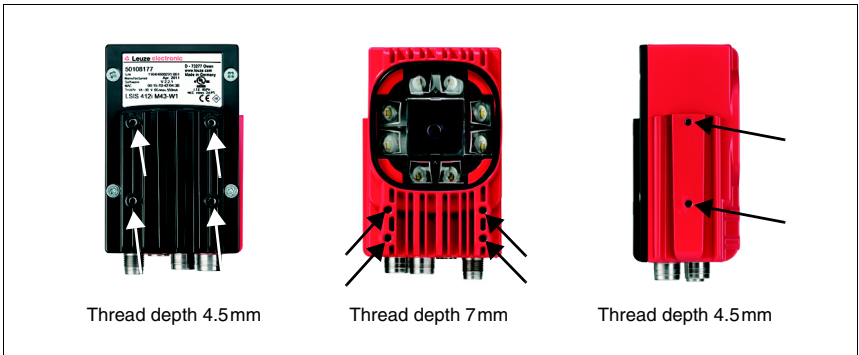

Figure 4.2: Fastening options using M4 threaded holes

4.2.2 Mounting devices

The BT 56 and BT 59 mounting devices are available for fastening the LSIS 4xx*i*. The BT 56 is designed for rod installation (Ø 16mm to 20mm). The BT 59 is used to fasten to ITEM aluminum profiles. For ordering instructions, please refer to chapter "Type overview and accessories" on page 52.

BT 56 mounting device

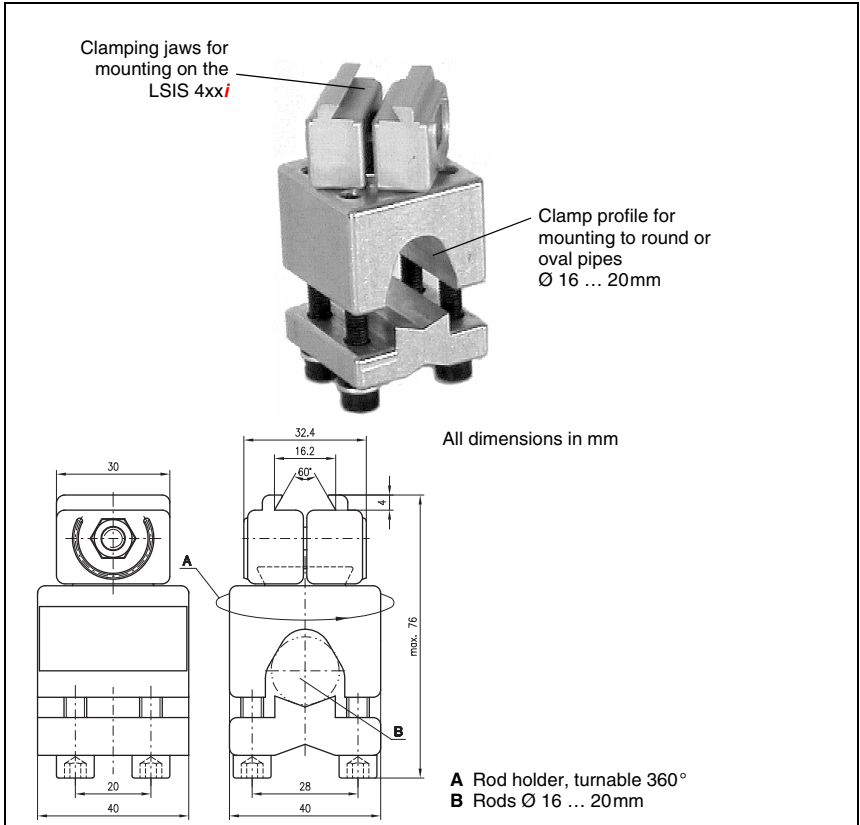

Figure 4.3: BT 56 mounting device

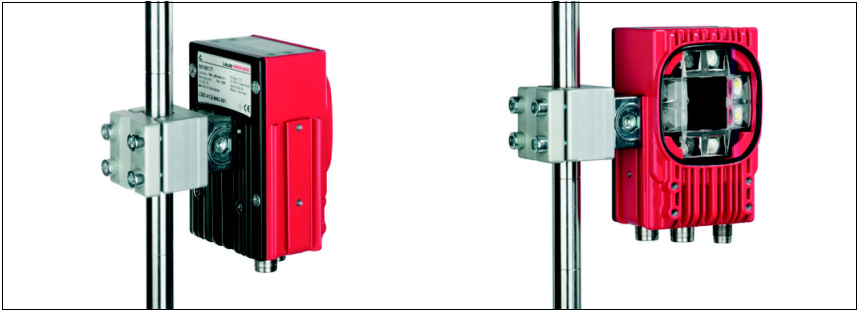

Figure 4.4: Mounting examples of LSIS 4xx*i* with BT 56

BT 59 mounting device

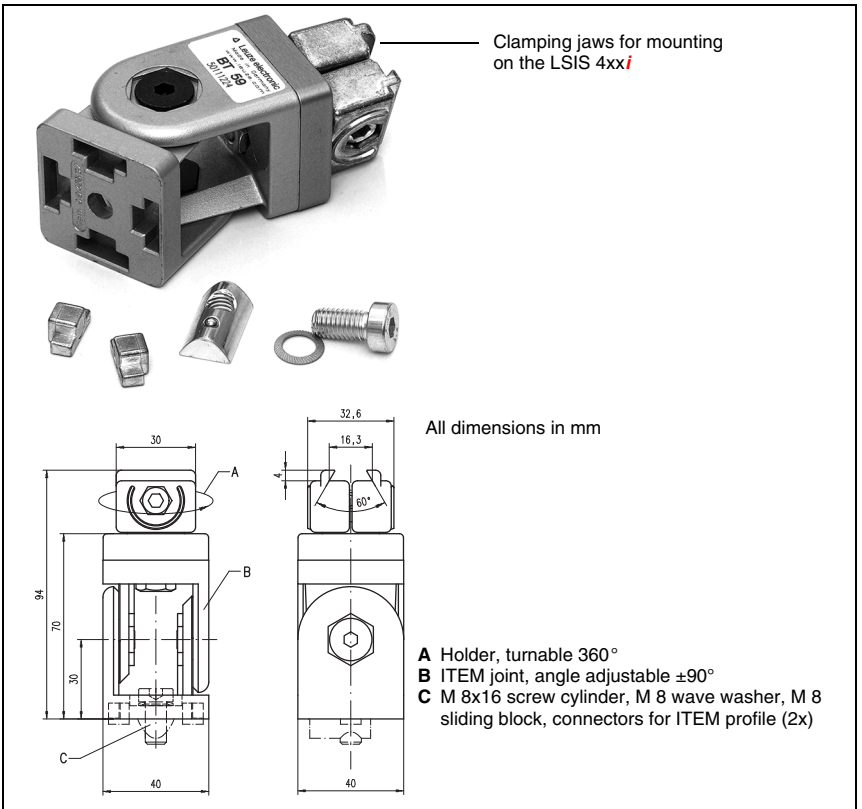

Figure 4.5: BT 59 mounting device

4.3 Device arrangement

4.3.1 Selecting a mounting location

In order to select the right mounting location, several factors must be considered:

- The camera distance which results from the respective field of view (see figure 4.6 on page 23 or figure 4.7 on page 24).
- The permissible cable lengths between the LSIS 4xx*i* and the host system depending on which interface is used.
- The display and control panel should be very visible and accessible.
- For configuring and commissioning with the webConfig tool, the service interface should be easily accessible.
- Mount the LSIS 4xx*i* so that the object being inspected is not exposed to direct sunlight or strong ambient light.

↳ *When selecting a mounting location, pay further attention to:*

- *Maintaining the required environmental conditions (temperature, humidity).*
- *Possible soiling of the viewing window due to liquids, abrasion by boxes, or packaging-material residues.*
- *Lowest possible chance of damage to the LSIS 4xx*i* by mechanical collision or jammed parts.*

4.3.2 Determining the camera distance

In figure 4.6 and figure 4.7, the principle relationship between camera distance and the resulting image field is represented for the C-mount device models.

In general, the visible image field increases with the camera distance. If a larger image field is needed, the camera distance must be increased accordingly. This also results in a decrease in the resolution of the image, however.

The diagram in figure 4.6 shows the relationship between camera distance (= path from the front edge of the camera to the object) and image field for standard devices with 8mm and 16mm focal length. In figure 4.7, this relationship is represented for the C-mount device models.

The following applies for devices with integrated illumination:

For camera distances between 50mm and 250mm, particularly homogeneous illumination of the image field is ensured.

Larger camera distances can be realized than are represented in the respective diagrams. In this case, the axis of the respective diagram is extrapolated.

Listed on the right side of the diagrams is the pixel size that corresponds to the respective image field. A segmented object is detected in the image only if at least 16 pixels in size.

The following minimum module or cell sizes apply for code readings:

- Printed, high-contrast codes: 3 pixels
- Directly marked, low-contrast codes: 5 pixels

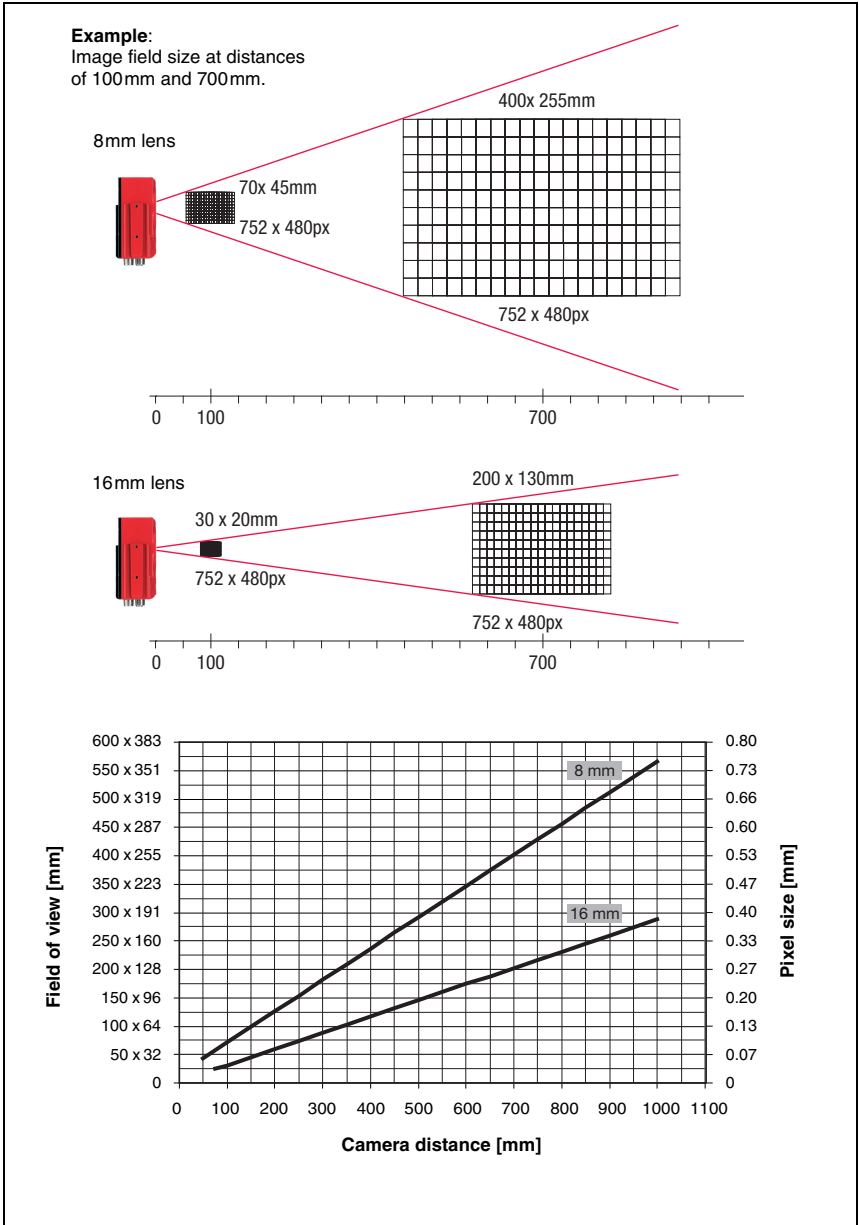

Figure 4.6: Camera distance / image field - standard devices

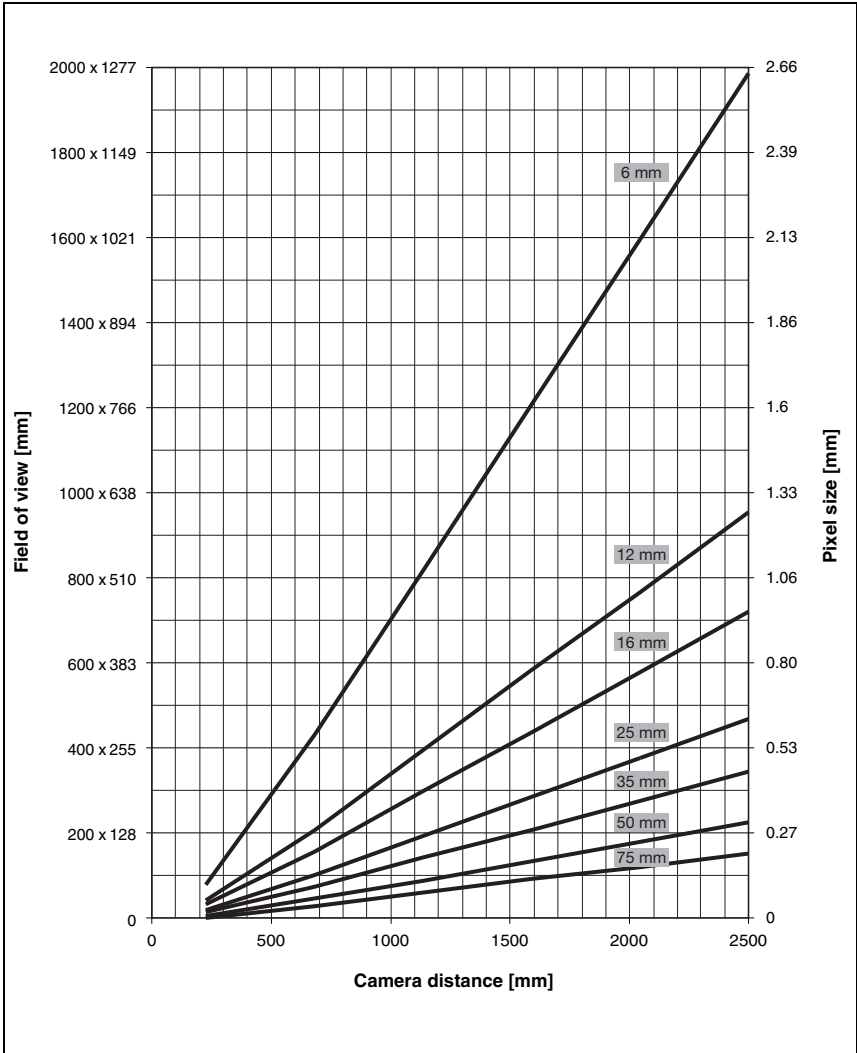

Figure 4.7: Camera distance / image field - device models for C-mount interchangeable lenses

4.4 Lens replacement LSIS 4xx*i* - C-mount devices

**Attention!**

Replace the lens in an environment that is as clean, dry and dust-free as possible. When doing so, make sure the lens cover is properly mounted to ensure protection class IP 65 / IP 67 is fulfilled.

- ↪ First loosen the 4 Phillips screws on the lens cover and remove the cover to the front as shown in figure 4.8.

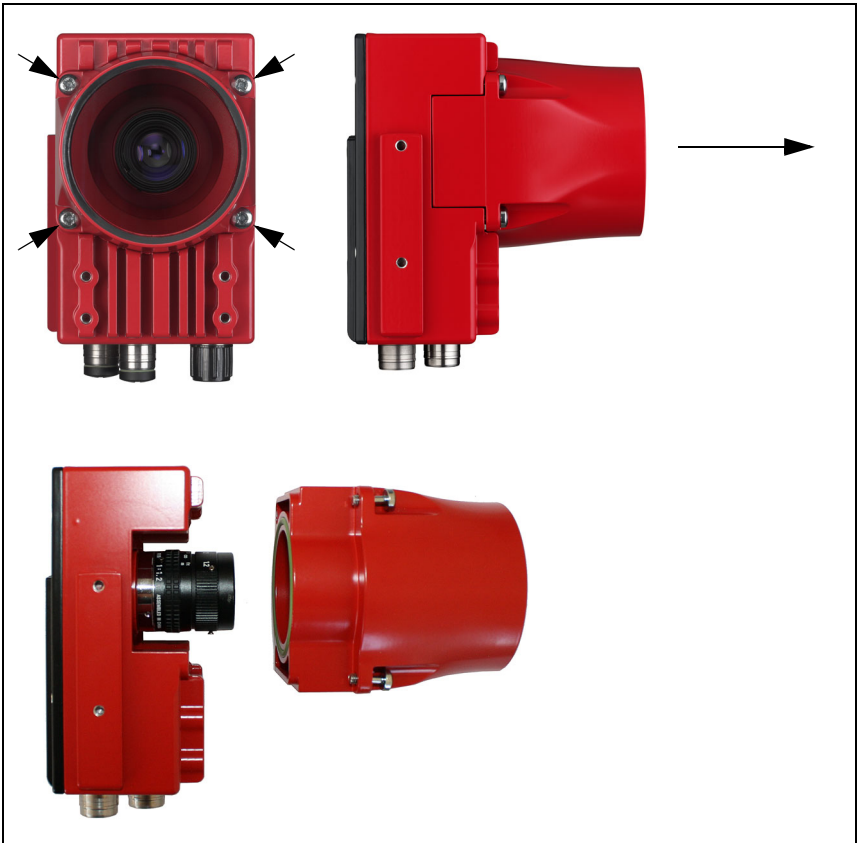

Figure 4.8: Lens replacement for C-mount devices

- ↪ Unscrew the installed C-mount lens from the lens mount in a clean environment by turning it counter-clockwise and screw the new lens on by turning it clockwise on the lens mount of the LSIS 4xx*i* M49-X9.



Notice!

Exchange and mounting of optical filters is described in the following chapter 4.5.

↪ Replace the lens cover and re-tighten it with the 4 Phillips screws. Clean the window of the lens cover of the LSIS 4xx*i* with a soft cloth after mounting.

4.5 Exchange / Mounting of optical filters

4.5.1 Mounting of optional polarization filter on standard device

An optional polarization filter (part no. 50113242, see chapter 9.3) can be mounted for the standard device models of the LSIS 4xx*i* with integrated illumination.

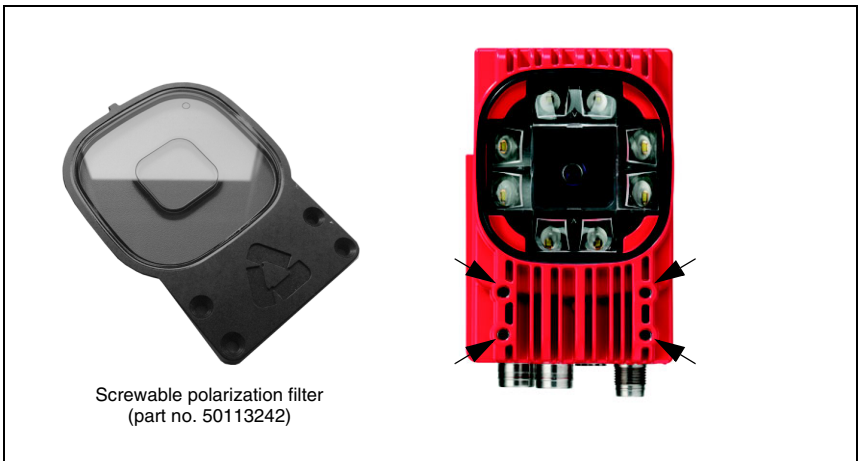

Figure 4.9: Optional polarization filter for standard devices

The filter is mounted by screwing into the 4 front threaded blind holes.

4.5.2 Filter exchange for C-mount device

By default, an infrared filter is mounted between the camera chip and lens in the C-mount device. If necessary, this can be replaced with a daylight blocking filter (part no. 50117985, see chapter 9.3) for applications that work with infrared light.



Attention!

Only replace the filter in an environment that is very clean, dry and dust-free. It is best to wipe off the replacement filter with a clean microfiber cloth before inserting the filter. Use suitable gloves when doing this!

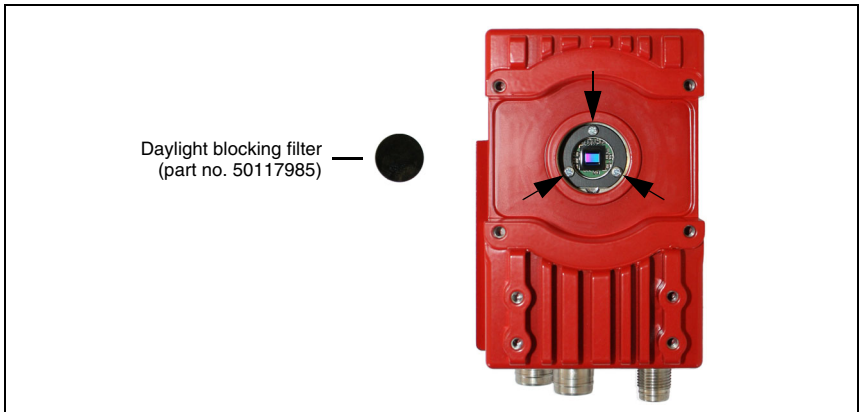

Figure 4.10: Filter replacement for C-mount devices

- ↪ First, remove the lens cover and the lens as described in chapter 4.4.
- ↪ Loosen the 3 retaining screws on the filter retaining ring (arrow in figure 4.10) and carefully remove the retaining ring.
- ↪ Carefully replace the filter plate.
No finger prints! Use lint-free gloves!
- ↪ Re-mount the filter retaining ring and then the lens and lens covers as described in chapter 4.4.



Notice!

Optionally, you can attach a conventional filter on the front filter thread of the C-mount compact lens.

4.6 Cleaning

- 👉 Clean the housing window of the LSIS 4xx*i* with a soft cloth after mounting. Remove all packaging remains, e.g. carton fibers or Styrofoam balls. In doing so, avoid leaving fingerprints on the front cover of the LSIS 4xx*i*.



Attention!

Do not use aggressive cleaning agents such as thinner or acetone for cleaning the device. Use of improper cleaning agents can damage the housing window and display.

Notice for model with plastic screen:

The surfaces are preferably to be cleaned with standard household dishwashing soap mixed in water, wiped with a soft cloth or sponge, and carefully dabbed dry (never rub intensely!). For a thorough cleaning, solvent-free, antistatic plastic cleaners approved for use with plastics are recommended. Never use abrasive cleaners or organic solvents such as alcohol or acetone, as these could scratch the surfaces or cause cracks to form.

5 Electrical connection

The smart cameras of the LSIS 4xx*i* series are connected using variously coded M12 connectors. This ensures unique connection assignments.

For the general locations of the individual device connections, please refer to the device detail shown below.



Notice!

Ready-made cables are provided for all connections. For additional information, refer to chapter 9.



Figure 5.1: Location of the electrical connections

5.1 Safety notices for the electrical connection

**Attention!**

*Do not open the device yourself under any circumstances! The housing of the LSIS 4xx*i* contains no parts that need to be adjusted or maintained by the user.*

Before connecting the device please ensure that the supply voltage matches the value printed on the nameplate.

Connection of the device and cleaning must only be carried out by a qualified electrician.

Ensure that the functional earth (FE) is connected correctly. Unimpaired operation is only guaranteed when the functional earth is connected properly.

If faults cannot be cleared, the device should be switched off from operation and protected against accidental use.

**Attention!**

For UL applications, use is only permitted in class 2 circuits in accordance with the NEC (National Electric Code).



*The smart cameras of the LSIS 4xx*i* series are designed in accordance with safety class III for supply by PELV (protective extra-low voltage) / SELV (safety extra-low voltage).*

**Notice!**

Protection class IP 65 / IP 67 is achieved only if the connectors and caps are screwed into place!

5.2 Electrical connection of the LSIS 4x2*i*

The LSIS 4x2*i* is equipped with three M12 connectors/sockets which are A- and B-coded. For subsequent interface variants, the space is reserved for a fourth connection.

- The **voltage supply** (18 ... 30VDC) is connected at the **PWR** connector (**Vin, GND**).
- The **8 freely configurable switching inputs/outputs** are connected to the **PWR** connector and to the **BUS OUT** socket (**IO1 ... IO8**).
- The **RS 232 interface** is a process interface of the LSIS 4xx*i*. It is connected to the **BUS OUT** socket (**Tx, Rx**).
- The **Ethernet cable for configuring and commissioning with webConfig** and for transferring process data is connected to the **SERVICE** connector.

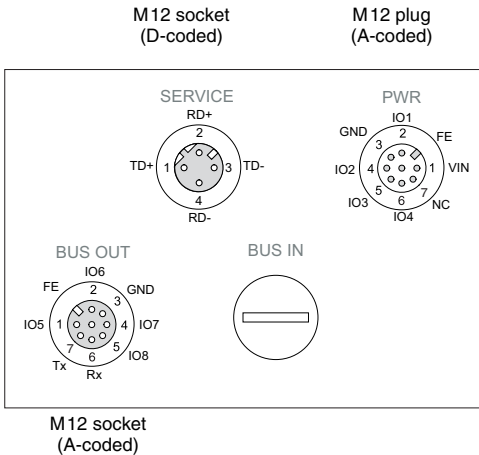

Figure 5.2: Connections of the LSIS 4x2*i*

Described in detail in the following are the individual connections and pin assignments.

5.2.1 PWR - voltage supply and switching inputs/outputs 1 to 4

PWR (8-pin connector, A-coded)			
	Pin	Name	Remark
<p style="text-align: center;">M12 plug (A-coded)</p>	1	VIN	Positive supply voltage +18 ... +30VDC
	2	IO1	Configurable switching input/output 1
	3	GND	Negative supply voltage 0VDC
	4	IO2	Configurable switching input/output 2
	5	IO3	Configurable switching input/output 3
	6	IO4	Configurable switching input/output 4
	7	NC	Not Connected
	8	FE	Functional earth
	Thread	FE	Functional earth (housing)

Table 5.1: Pin assignments - PWR

↳ Preferably, use the "KD S-M12-8A-P1-..." ready-made cables, see table 9.6 "PWR cables for the LSIS 4xxi" on page 54.

Supply voltage



Attention!

For UL applications, use is only permitted in class 2 circuits in accordance with the NEC (National Electric Code).



The smart cameras of the LSIS 4xxi series are designed in accordance with safety class III for supply by PELV (protective extra-low voltage) / SELV (safety extra-low voltage).

Connecting functional earth FE

↳ Ensure that the functional earth (FE) is connected correctly. Unimpaired operation is only guaranteed when the functional earth is connected properly. All electrical disturbances (EMC couplings) are discharged via the functional earth connection.

Switching input / output

The smart cameras LSIS 4x2i feature 8 freely programmable, opto-decoupled switching inputs / outputs IO1 ... IO8.

The switching inputs can be used to activate various internal functions of the LSIS 4xxi (triggering of image acquisition, check program selection ...). The switching outputs are used for the output of result and status messages and for triggering an external flash control.

Switching inputs/outputs IO1 to IO4 are located on the PWR M12 connector.

Switching inputs/outputs IO5 to IO8 are located on the BUS OUT M12-socket.



Notice!

Assignment as input or output and the corresponding function can be set via webConfig!

If not explicitly configured in webConfig, the ports are preset as follows:

- IO1 start trigger input, triggers image acquisition
- IO2 result OK output, switches in event of positive evaluation result
- IO3 result NOK output, switches in event of negative evaluation result
- IO4 ready output, switches when ready for operation

Described in the following is the external wiring for use as a switching input or output; the respective function assignments to the switching inputs/outputs are set in webConfig.

Function as switching input

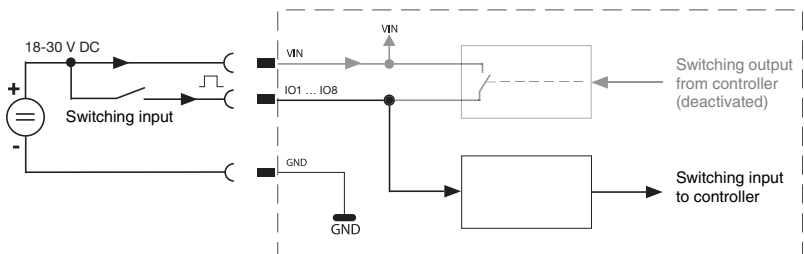

Figure 5.3: Connection diagram of IO1 through IO8 configured as switching inputs

Function as switching output

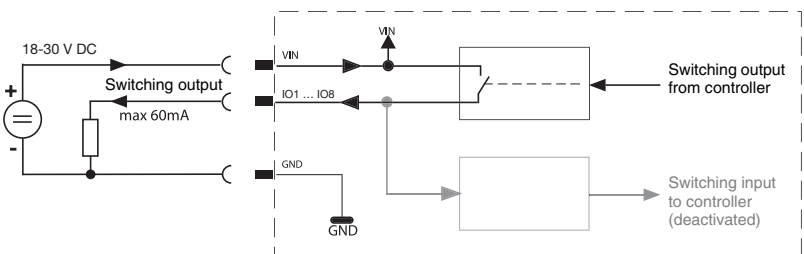

Figure 5.4: Connection diagram of IO1 through IO8 configured as switching outputs



Attention!

Each configured switching output is short-circuit proof! Do not load the respective switching output of the LSIS 4xxi with more than 60mA at +18 ... +30VDC in normal operation!

5.2.2 BUS OUT - RS 232 and switching inputs/outputs 5 to 8

The RS 232 interface is used to output test results, see webConfig manual for details.

BUS OUT (8-pin socket, A-coded)			
	Pin	Name	Remark
<p>BUS OUT</p> <p>M12 socket (A-coded)</p>	1	IO5	Configurable switching input/output 5
	2	IO6	Configurable switching input/output 6
	3	GND	Negative supply voltage 0VDC
	4	IO7	Configurable switching input/output 7
	5	IO8	Configurable switching input/output 8
	6	Rx	Rx signal (RS 232)
	7	Tx	Tx signal (RS 232)
	8	FE	Functional earth
	Thread	FE	Functional earth (housing)

Table 5.2: Pin assignment BUS OUT

↳ Preferably, use the "KS S-M12-8A-P1-..." ready-made cables, see table 9.8 "BUS OUT cables for the LSIS 4xxi" on page 55:

If using self-made cables, observe the following notice:



Notice for connecting the RS 232 interface!

Ensure adequate shielding. The entire connection cable must be shielded and earthed.

RS 232 cable assignments

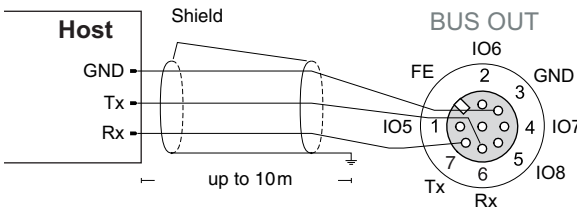

Figure 5.5: RS 232 pin assignments

Switching input / output

The freely configurable switching inputs/outputs are described in chapter 5.2.1.

5.2.3 SERVICE - Ethernet host/configuration interface

The LSIS 4xx*i* makes an Ethernet interface available for configuration and for transferring process data.

SERVICE (4-pin socket, D-coded)			
SERVICE	Pin	Name	Remark
<p>M12 socket (D-coded)</p>	1	TD+	Transmit Data +
	2	RD+	Receive Data +
	3	TD-	Transmit Data -
	4	RD-	Receive Data -
	Thread	FE	Functional earth (housing)

Table 5.3: SERVICE pin assignments

↳ Preferably, use the ready-made "KS ET-M12-4A-P7-...", "KSS ET-M12-4A-M12-4A-P7-..." and "KSS ET-M12-4A-RJ45-A-P7-..." cables, see "Accessories for the host/service interface" on page 56.

If using self-made cables, observe the following notice:



Notice for connecting the Ethernet interface!

Ensure adequate shielding. The entire connection cable must be shielded and earthed. The RD+/RD- and TD+/TD- wires must be stranded in pairs. Use at least CAT 5 cables for the connection.

Ethernet cable assignment

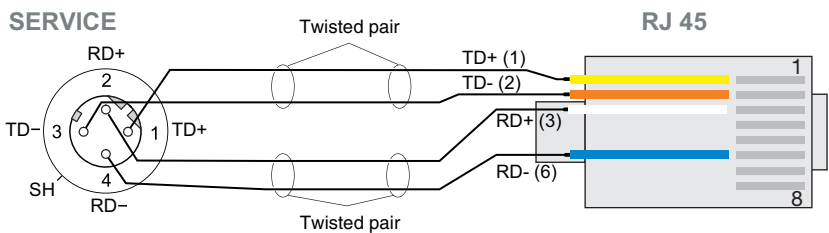

The depicted core colors apply only for Leuze cables and are not compliant with EIA/TIA 568A and EIA/TIA 568B.

Figure 5.6: Cable assignments - SERVICE on RJ-45

6 Commissioning and configuration

6.1 Establishing a connection between PC and LSIS 4xx*i*

6.1.1 Starting the device

Apply the supply voltage +18 ... +30VDC (typ. +24VDC).

The camera starts up and the following message appears on the display:

```
Startup...
Leuze electronic
  GmbH + Co. KG
```

After a few seconds, brief device information appears.

```
LSIS 412i M43 W1
Leuze electronic
  GmbH + Co. KG

SW: V 0.51.0 HW:0
SN: 0902-082905016
```

Afterwards, the LSIS 4xx*i* switches to normal operation and displays the active interfaces as a status message.

```
RS232
```

6.1.2 Establishing an Ethernet connection

The Ethernet connection is used as the host interface and for configuring the LSIS 4xx*i* via a PC with a browser.



Notice!

*In order for the PC and LSIS 4xx*i* to communicate with one another, both must be on the same subnet and have different network addresses.*

Normally, it is sufficient to adjust the Ethernet settings (= TCP/IP configuration) on one of the two devices (LSIS 4xx*i*/PC) to those of the other device.

If the PC is normally connected to a network using DHCP address assignment, the easiest way to access the LSIS 4xx*i* is to create an alternative configuration in the TCP/IP settings of the PC. This method lends itself if the LSIS 4xx*i* is not connected to an existing network during later operation. For further information on this topic, refer to chapter 6.1.3.

Alternatively, you can also integrate the LSIS 4xx*i* in an existing network and configure it from a PC that is also connected to the network. For further information on this topic, refer to chapter 6.1.4.

6.1.3 Configuring the LSIS 4xx*i* from a laptop without a network

↪ Check the network address of the LSIS 4xx*i* by pressing the enter button  three times in sequence during normal operation of the LSIS 4xx*i*.

This switches you to the Network settings submenu, where you can read the current settings of the LSIS 4xx*i*.

↪ Note the values for Addr and Mask.

The value in Mask specifies which digits of the IP address of the PC and LSIS 4xx*i* must match in order to communicate with one another.

Address of the LSIS 4xx <i>i</i>	Net mask	Address of the PC
192.168.060.101	255.255.255.0	192.168.060.xxx
192.168.060.101	255.255.0.0	192.168.xxx.xxx

Table 6.1: Address assignment in the Ethernet

Instead of xxx, you can now assign your PC any numbers between 000 and 255, but NOT THE SAME numbers as used with the LSIS 4xx*i*.

E.g. 192.168.060.110 (but not 192.168.060.101!).

If the LSIS 4xx*i* and the PC have the same IP address, they cannot communicate with one another.

Setting the IP address on the PC

↪ Log into your PC as administrator.

↪ Select Start->Control Panel to access the Network Connections menu (Windows 2000/XP) or Network and Sharing Center (Windows Vista/Windows 7).

↪ There, select Local Area Connection and right-click to open the corresponding properties page.

↪ Select Internet Protocol (TCP/IP) (scroll down if necessary) and click Properties.

↪ In the Internet Protocol (TCP/IP) Properties window, select the Alternate Configuration tab.

↪ Set the IP address of the PC in the address range of the LSIS 4xx*i*.

Attention: Not the same as for the LSIS!

↪ Set the subnet mask of the PC to the same value as on the LSIS 4xx*i*.

↪ Close the settings dialog by confirming all windows with OK.

↪ Connect the "Service" interface of the LSIS 4xx*i* directly to the LAN port of your PC.

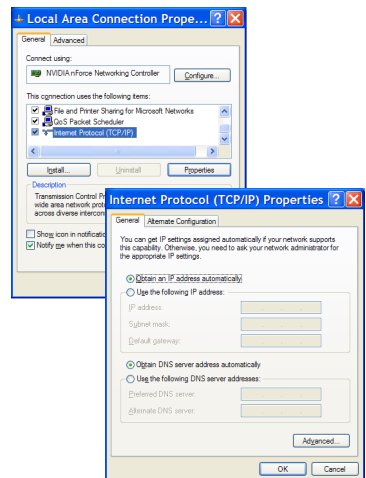



Figure 6.1: Connecting the LSIS 4xx*i* to the PC

The PC first tries to establish a network connection via the automatic configuration. This takes a few seconds, after which the alternate configuration, which you just set, is activated. The PC can then communicate with the LSIS 4xx*i*.

6.1.4 Integrating the LSIS 4xx*i* in an existing network

If it should be possible to reconfigure the LSIS 4xx*i* later during running operation and if a network connection is present at the installation site, you can set the LSIS 4xx*i* according to the parameters of the existing network. In principle, it is possible in this case to have the address set automatically by means of DHCP, or you can assign a fixed address.

↳ Ask your network administrator which method is to be used and — if using fixed address assignment — which settings should be used for address, subnet mask and gateway.

With DHCP server

↳ Use the display on the LSIS to activate the DHCP function (see "Changing the network settings on the display" on page 49).

Following activation of the DHCP function, the sensor automatically restarts. If you now connect the sensor to a network with DHCP server, it is automatically assigned an IP address.

You can now configure the LSIS 4xx*i* via any PC on the same network.

With fixed IP address

↳ Use the display on the LSIS to set the parameters previously received by the network administrator (see "Changing the network settings on the display" on page 49).

The sensor restarts after the Ethernet configuration is changed. If you now connect the sensor to a network, it operates with the manually assigned IP address.

You can now configure the LSIS 4xx*i* via any PC on the same network.

6.2 Configuring via webConfig

With **Leuze webConfig**, an operating-system independent, web-technology based, graphical user interface is available for configuring smart cameras of the **LSIS 4xx*i*** series.

Through the use of HTTP as communication protocol and by using only standard technologies on the client side (HTML, JavaScript and AJAX), which are supported by all commonly used, modern browsers (e.g. **Mozilla Firefox** beginning with Version 3.0 or **Internet Explorer** beginning with Version 8.0), it is possible to operate the **Leuze webConfig tool** on any internet-ready PC.

Start a browser on your PC and enter the following address: **192.168.60.101** or the address previously set by you / the address assigned by the DHCP server.

192.168.60.101 is the default Leuze service address for communication with the smart cameras of the **LSIS 4xx*i*** series.

You can check the network address of the **LSIS 4xx*i*** by pressing the enter button (⏏) on the display three times in sequence during normal operation of the **LSIS 4xx*i***.

If the IP address is entered correctly in the browser, the following start page appears on your PC.

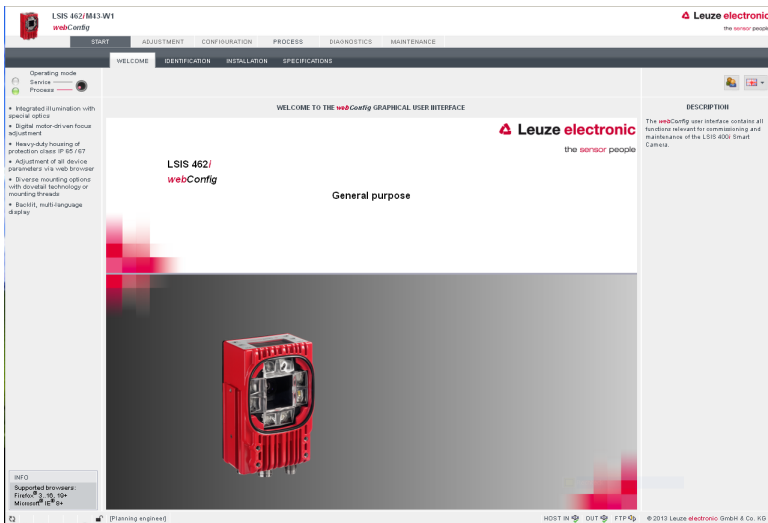

Figure 6.2: webConfig start page



Notice!

*The webConfig tool is completely contained in the firmware of the LSIS 4xx*i*. Depending on firmware version, the start page may vary from that shown above.*

The webConfig menus are intuitive to operate and contain both help texts as well as tooltips. Because the webConfig user interface is always being developed further, it is described in a separate software description. All released versions of this software description can be found in the download area of the Leuze electronic homepage: [www.leuze.com/...](http://www.leuze.com/)

Activities in webConfig

Use webConfig to set up the LSIS 4xx*i*. When doing so, observe the following points:

- Configure at least one check program and activate it.
- Set up one of the 8 IOs as a trigger input for the check program. Make certain that this input is correctly connected (see chapter 5.2).
- If you use the RS 232 interface to communicate with the process control, you must configure the transmission parameters of the RS 232 interface in the data output tool of the respective check program.

For information on how that functions in webConfig, please refer to the webConfig software description.

7 Display and control panel

7.1 Structure of the control panel

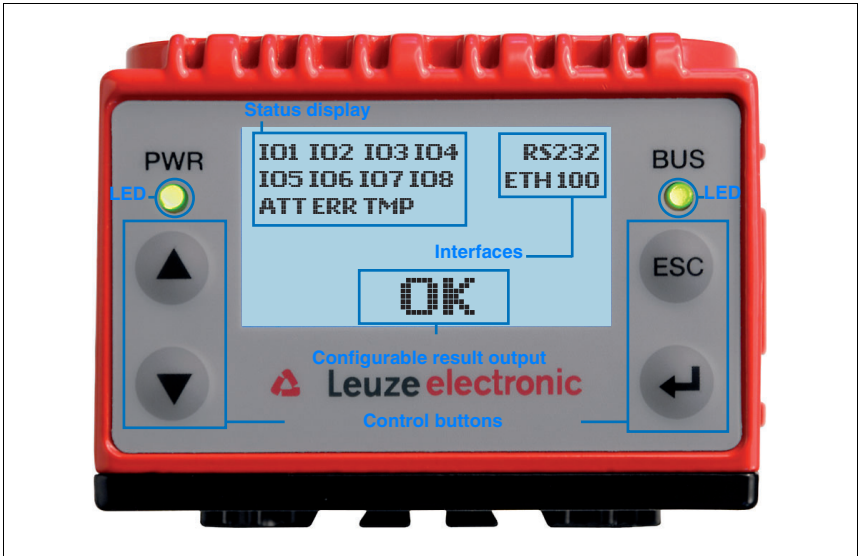

Figure 7.1: Structure of the control panel

7.2 Status display and operation

7.2.1 Indicators in the display

IO1 ... IO8 Switching input or output 1 ... 8 active (function depends on set configuration).

ATT Warning (Attention)

ERR Internal device error (Error)

TMP Permissible internal device temperature exceeded / not met





RS232 Type of integrated process interface

ETH Status display for the Ethernet connection:



- ETH100 means that a 100Mbit Ethernet connection exists.
- ETH10 means that a 10Mbit Ethernet connection exists.
- If ETH is not displayed, there is no Ethernet connection.

In the center of the display, optional check program-specific displays can be displayed.

7.2.2 Control buttons

-  **Up** **Navigate upward/laterally.**
-  **Down** **Navigate downward/laterally.**
-  **ESC** **Exit menu item.**
-  **ENTER** **Confirm/enter value, change menu levels.**

Navigating within the menus

The menus within a level are selected with the up/down buttons  .

The selected menu item is activated with the enter button .





Press the ESC button  to move up one menu level.

When one of the buttons is actuated, the display illumination is activated for 10 min.

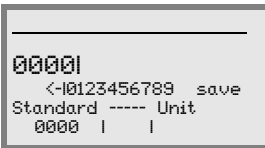
Setting values

If input of a value is possible, the display looks like this:







Use the   and  buttons to set the desired value. An accidental, incorrect entry can be corrected by selecting <-| and then pressing .

Then use the   buttons to select `save` and save the set value by pressing .

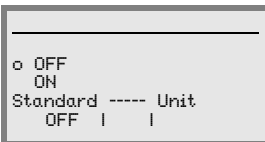
Selecting options

If options can be selected, the display looks like this:



Select the desired option with the   buttons. Activate the option by pressing .

7.2.3 LED status displays

PWR LED

PWR



off

Device OFF

- no supply voltage

PWR



flashes green

Device ok, initialization phase

- no inspection possible
- voltage connected
- self test running
- initialization running
- check program is activated

PWR



green continuous light Device ok

- inspection mode
- self test successfully finished
- device monitoring active

PWR



orange continuous light Service mode

- configuration mode
- configuration via webConfig

PWR



flashes red

Device ok, warning set

- inspection mode
- temporary operating fault
- for details, see "Error signaling via LED" on page 51

PWR



red continuous light Device error / parameter enable

- no inspection possible
- for details, see "Error signaling via LED" on page 51

BUS LED

BUS



off

No supply voltage

- no communication possible

BUS



flashes green

Bus initialization

- can be very short, 1 pulse

BUS



green continuous light BUS ok

- device ready for sending/receiving

BUS



flashes red

Communication error

- UART error (frame error, parity error, ...)

7.3 Menu description

After voltage is applied to the smart camera, a startup screen is displayed for several seconds. Afterwards, the main menu appears in the display.

7.3.1 The main menus



Device information - main menu

Information about

- Device type
- Software version
- Hardware version
- Serial number

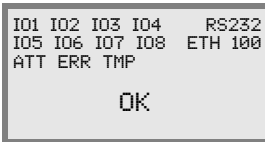

Status displays - main menu

- Status displays of the switching inputs/outputs
 - Display of warnings and errors
 - Status information for the device interfaces
 - Optional: check program-specific display
- See "Status displays" on page 45.

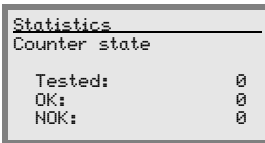

Statistics - main menu

Statistics data for the smart camera.
See "Statistics" on page 45.

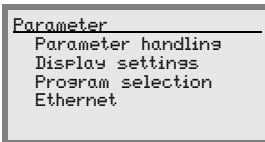

Parameter - main menu

Configuration of the smart camera.
See "Parameter menu" on page 46.

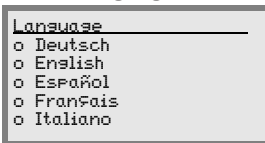

Language selection - main menu

Selection of the display language.
See "Language selection menu" on page 47.

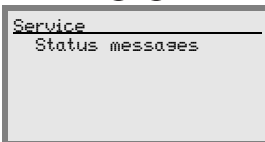

Service - main menu

Camera diagnosis and status messages.
See "Service menu" on page 47.



Notice!

The display offers only limited configuration options. The configurable parameters are described here in chapter 7.3. Only the webConfig provides complete configuration options and is largely self-explanatory. The use of the webConfig tool is described in chapter 6. There, you will also find notes on commissioning with the aid of webConfig.

7.3.2 Status displays

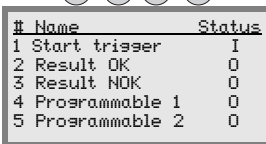
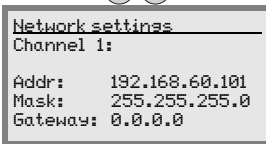
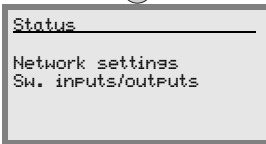
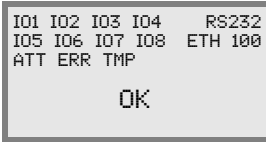

Status displays - main menu

- Status displays of the switching inputs/outputs
 - Display of warnings and errors
 - Status information for the device interfaces
 - Optional: check program-specific display
- See "Indicators in the display" on page 41.

Press the enter button to select between network settings and switching inputs and outputs.

The Network settings submenu offers information on the set network address of the LSIS 4xx*i*, the corresponding net mask and the gateway address.

Value "Channel 1" is displayed by default. Currently (06/2009), only one Ethernet channel is supported.

The Sw. inputs / outputs submenu offers information on the current configuration of the IOs of the LSIS 4xx*i*. For each of the 8 IOs, the assigned name and state are displayed (input = I/output = O).

7.3.3 Statistics

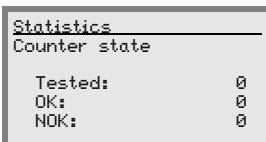

Statistics - main menu

In the Statistics menu, you can see the total number of parts that have been checked since the last time the counter was reset, how many test results were OK and how many were not OK.

7.3.4 Parameter menu

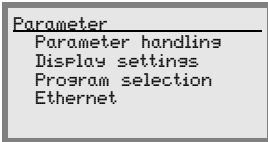

Parameter - main menu

Editing Ethernet addressing and selecting check programs stored on the LSIS 4xx*i*.

Parameter handling

The Parameter handling submenu is used to lock and release the parameter input via the display and for resetting to default values.

Level 3	Level 4	Selection/configuration option Description	Standard
Parameter enable		OFF/ON <i>The standard setting (OFF) prevents unintended parameter changes. If parameter enabling is activated (ON), parameters can be changed manually.</i>	OFF
Default parameters		<i>By pressing the enter button (↵) after selecting Parameters to default, all parameters are reset to their standard settings without any further security prompts. In this case, English is selected as the display language.</i>	

Table 7.1: Parameter handling submenu

Display settings

In the Display settings submenu, the complete display can be turned upside down, meaning turned by 180°, via the Turn by 180° menu item to enable good display readability at the mounting site, if necessary.

Program selection

In the Program selection submenu, a scrollbar can be used to activate any of the check programs stored on the LSIS 4xx*i*.

A selected program is immediately activated by pressing the enter button. If, however, a test cycle is currently being executed at this moment, this test cycle is executed to completion and evaluated.

As the new check program is being activated, the green "PWR" LED flashes.

Level 3	Level 4	Selection/configuration option Description	Standard
Program name 1		<i>Here, you will find check programs previously set in webConfig.</i>	
Program name 2			
Program name 3			
...			

Table 7.2: Program selection submenu

Ethernet

The host/service interface of the LSIS 4xx*i* is configured in the Ethernet submenu.

Level 3	Level 4	Selection/configuration option <i>Description</i>	Standard
Ethernet 1	IP address	The IP address can be set to any value in the xxx.xxx.xxx.xxx format. <i>Normally, the network administrator specifies the IP address that is to be set here. If DHCP is activated, the setting made here has no effect and the LSIS 4xx<i>i</i> is set to the values that it obtains from the DHCP server.</i>	192.168.060.101
	Gateway	The gateway address can be set to any value in the xxx.xxx.xxx.xxx format. <i>The LSIS 4xx<i>i</i> communicates with participants in other subnets via the gateway. Splitting the read application over multiple subnets is rather uncommon; the setting of the gateway address, thus, usually has no meaning.</i>	000.000.000.000
	Net mask	The net mask can be set to any value in the xxx.xxx.xxx.xxx format. <i>Usually, the LSIS 4xx<i>i</i> is used in a private Class C network and the default setting can be accepted without change.</i> Attention: It is possible to enter any values for xxx.xxx.xxx.xxx. Only the values 255 or 000 are permissible for xxx, however. If other values are set, an error message appears upon restart of the LSIS 4xx <i>i</i> .	255.255.255.000
	DHCP activated	Off/On <i>If DHCP is activated, the LSIS 4xx<i>i</i> draws its settings for IP address, gateway and net mask from a DHCP server. The manual settings made above have no effect, but are retained and are again active if DHCP is deactivated.</i>	Off

Table 7.3: Ethernet submenu

7.3.5 Language selection menu

5 display languages are available:

- Deutsch (German)
- English
- Español (Spanish)
- Français (French)
- Italiano (Italian)

7.3.6 Service menu

Status messages

This menu item is used exclusively for service purposes by Leuze electronic.

7.4 Operation

Shown here is an example describing important operating procedures in detail.

Parameter enabling

During normal operation parameters can only be viewed. If parameters need to be changed, the **ON** menu item in the **Parameter enabling** menu must be activated. To do this proceed as follows:

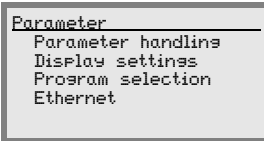

In the Parameter menu, use the buttons to select the Parameter handlings menu item.

Press the enter button to enter the Parameter handlings menu.

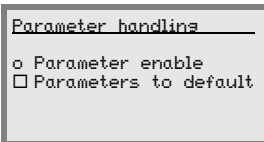

In the Parameter handling menu, use the buttons to select the Parameter enable menu item.

Press the enter button to enter the Parameter enable menu.

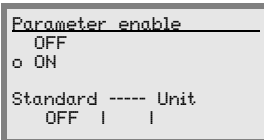

In the Parameter enable menu, use the buttons to select the ON menu item.

Press the enter button to switch on parameter enabling.

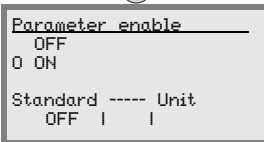

The PWR LED lights up orange. You can now set individual parameters via the display.

Press the ESC button twice to return to the main menu.

Network configuration

Information on network configuration can be found in chapter "Commissioning and configuration" on page 36. If you need to set the IP address of the LSIS 4xx*i* via the display, proceed as follows:

Changing the network settings on the display

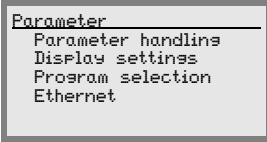

In the Parameter menu, use the buttons to select the Ethernet menu item.



Press the enter button to enter the Ethernet menu.



Press the enter button again to enter the Ethernet 1 menu.

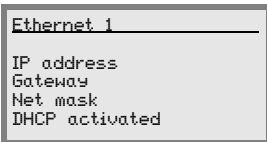

Use the buttons successively to select the IP address, Gateway and Net mask menu items and set the desired values or activate the DHCP function.



Exit the Ethernet 1 menu with the ESCAPE button.

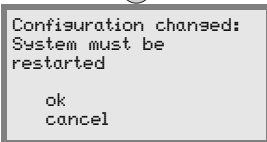

The message shown at the side appears. Confirm with OK to initiate a restart and to activate the changed configuration.

Check program selection

During running operation of the LSIS 4xx*i*, you can simply change the check program via the display. Prerequisite for this is that multiple check programs were set up previously via webConfig.

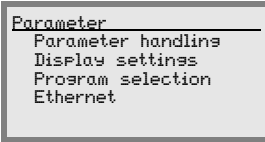

In the Parameter menu, use the ▲▼ buttons to select the Program selection menu item.



Press the enter button to enter the Parameter handling menu.

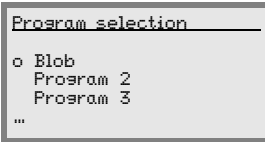

In the Program selection menu, use the ▲▼ buttons to select the desired check program.



Press the enter button to activate the check program. A selected program is immediately activated by pressing the enter button. If, however, a test cycle is currently being executed at this moment, this test cycle is executed to completion and evaluated.



As the new check program is being activated, the green "PWR" LED flashes.

Press the ESC button twice to return to the main menu.

8 Diagnostics and troubleshooting

8.1 Error signaling via LED

Error	Possible error causes	Measures
Status LED PWR		
Off	<ul style="list-style-type: none"> No supply voltage connected to the device Hardware error 	<input type="checkbox"/> Check supply voltage <input type="checkbox"/> Send device to customer service
Red, flashing	<ul style="list-style-type: none"> Warning 	<input type="checkbox"/> Query diagnostic data and carry out the resulting measures
Red, continuous light	<ul style="list-style-type: none"> Error: function may be impossible 	<input type="checkbox"/> Internal device error
Orange, continuous light	<ul style="list-style-type: none"> Device in service mode (parameter enable) 	<input type="checkbox"/> Reset service mode with webConfig or display
Status LED BUS		
Off	<ul style="list-style-type: none"> No supply voltage connected to the device Hardware error 	<input type="checkbox"/> Check supply voltage <input type="checkbox"/> Send device to customer service
Red, flashing	<ul style="list-style-type: none"> Communication error 	<input type="checkbox"/> Check interface

Table 8.1: General causes of errors



Notice!

Please use **chapter 8 as a master copy** should servicing be required.

Cross the items in the "Measures" column which you have already examined, fill out the following address field and fax the pages together with your service contract to the fax number listed below.

Customer data (please complete)

Device type:	
Software version :	
Company:	
Customer order number:	
Contact person/ Department:	
Phone (direct):	
Fax:	
Street / No:	
ZIP code/City:	
Country:	

Leuze Service fax number:

+49 7021 573 - 199

9 Type overview and accessories

9.1 Type overview LSIS 4xx*i* - standard devices

Type designation	Focal length of lens	Housing window	Color of LED illumination	Function range			Part no.
				Blob analysis	Code reading	Measuring tool	
LSIS 412i M43-W1	8mm	Glass	White	●			50108177
LSIS 412i M43-W1-01	8mm	Plastic	White	●			50112928
LSIS 412i M43-I1	8mm	Glass	Infrared	●			50116970
LSIS 412i M43-I1-01	8mm	Plastic	Infrared	●			50116969
LSIS 412i M43-M1	8mm	Glass	RGBW	●			50116972
LSIS 412i M43-M1-01	8mm	Plastic	RGBW	●			50116971
LSIS 412i M45-W1	16mm	Glass	White	●			50108990
LSIS 412i M45-W1-01	16mm	Plastic	White	●			50112929
LSIS 412i M45-I1	16mm	Glass	Infrared	●			50116974
LSIS 412i M45-I1-01	16mm	Plastic	Infrared	●			50116973
LSIS 412i M45-M1	16mm	Glass	RGBW	●			50116976
LSIS 412i M45-M1-01	16mm	Plastic	RGBW	●			50116975
LSIS 422i M43-W1	8mm	Glass	White		●		50108178
LSIS 422i M43-W1-01	8mm	Plastic	White		●		50113055
LSIS 422i M43-I1	8mm	Glass	Infrared		●		50116978
LSIS 422i M43-I1-01	8mm	Plastic	Infrared		●		50116977
LSIS 422i M43-M1	8mm	Glass	RGBW		●		50116980
LSIS 422i M43-M1-01	8mm	Plastic	RGBW		●		50116979
LSIS 422i M45-W1	16mm	Glass	White		●		50109829
LSIS 422i M45-W1-01	16mm	Plastic	White		●		50113054
LSIS 422i M45-I1	16mm	Glass	Infrared		●		50116982
LSIS 422i M45-I1-01	16mm	Plastic	Infrared		●		50116981
LSIS 422i M45-M1	16mm	Glass	RGBW		●		50116984
LSIS 422i M45-M1-01	16mm	Plastic	RGBW		●		50116983
LSIS 462i M43-W1	8mm	Glass	White	●	●	●	50113053
LSIS 462i M43-W1-01	8mm	Plastic	White	●	●	●	50113052
LSIS 462i M43-I1	8mm	Glass	Infrared	●	●	●	50116986
LSIS 462i M43-I1-01	8mm	Plastic	Infrared	●	●	●	50116985
LSIS 462i M43-M1	8mm	Glass	RGBW	●	●	●	50116988
LSIS 462i M43-M1-01	8mm	Plastic	RGBW	●	●	●	50116987
LSIS 462i M45-W1	16mm	Glass	White	●	●	●	50113051
LSIS 462i M45-W1-01	16mm	Plastic	White	●	●	●	50113037
LSIS 462i M45-I1	16mm	Glass	Infrared	●	●	●	50116990
LSIS 462i M45-I1-01	16mm	Plastic	Infrared	●	●	●	50116989
LSIS 462i M45-M1	16mm	Glass	RGBW	●	●	●	50116992
LSIS 462i M45-M1-01	16mm	Plastic	RGBW	●	●	●	50116991

Table 9.1: Type overview LSIS 4xx*i* - standard devices

9.2 Type overview LSIS 4xx*i* - C-mount devices and lenses

C-mount device models

Type designation	Focal length of lens	Housing window	Color of LED illumination	Function range			Part no.
				Blob analysis	Code reading	Measuring tool	
LSIS 412 <i>i</i> M49-X9	see lens	Glass	–	●			50117094
LSIS 412 <i>i</i> M49-X9-01	see lens	Plastic	–	●			50121148
LSIS 422 <i>i</i> M49-X9	see lens	Glass	–		●		50117093
LSIS 462 <i>i</i> M49-X9	see lens	Glass	–	●	●	●	50117091

Table 9.2: Type overview LSIS 4xx*i* - C-mount devices

C-mount lenses

Type designation	Description	Focal length	Diaphragm	Part no.
V-LENS-K-C-6-F1,4-1/2-01	High-resolution C-mount compact lens CP 6-M	6mm	1.4	50117050
V-LENS-K-C-12-F1,4-1/2-01	High-resolution C-mount compact lens CP 12-M	12mm	1.4	50037055
V-LENS-K-C-16-F1,4-2/3-01	High-resolution C-mount compact lens CP 16-M	16mm	1.4	50117051
V-LENS-K-C-25-F1,4-2/3-01	High-resolution C-mount compact lens CP 25-M	25mm	1.4	50117052
V-LENS-K-C-35-F1,6-2/3-01	High-resolution C-mount compact lens CP 35-M	35mm	1.6	50104978
V-LENS-K-C-50-F2,8-2/3-01	High-resolution C-mount compact lens CP 50-M	50mm	2.8	50036468
V-LENS-K-C-75-F2,8-2/3-01	High-resolution C-mount compact lens CP 75-M	75mm	2.8	50117053

Table 9.3: Type overview LSIS 4xx*i* - C-mount lenses

9.3 Accessories

Type designation	Description	Part no.
BT 56	Mounting device with dovetail for rod	50027375
BT 59	Mounting device with dovetail for ITEM aluminum profile	50111224
LSIS-ZUB-FIL-01	Screwable polarization filter for standard devices with integrated illumination	50113242
LSIS-ZUB-FIL-02	Daylight blocking filter for C-mount devices	50117985
REF 7A-100x100	Adhesive reflective tape, 100mm x 100mm	50111527
REF 7A-200x300	Adhesive reflective tape, 200mm x 300mm	50116687
REF 7A-1000x600	Adhesive reflective tape, 1000mm x 600mm	50115444

Table 9.4: Accessories for the LSIS 4xx*i*



Notice!

External illuminations can be found in the current "Identification systems/Data transmission systems/Distance measurement" catalog under "Industrial image processing" -> "Image processing- general accessories"

9.4 Accessory ready-made cables for voltage supply

9.4.1 Contact assignment of PWR connection cable

PWR connection cable (8-pin socket, A-coded)			
	Pin	Name	Core color
	1	VIN	White
	2	IO1	Brown
	3	GND	Green
	4	IO2	Yellow
	5	IO3	Gray
	6	IO4	Pink
	7	NC	Blue
	8	FE	Red
	Thread	FE	Bright

Table 9.5: Pin assignments KD S-M12-8A-P1-...

9.4.2 Order codes of the cables for voltage supply

Type designation	Description	Part no.
M12 socket for PWR, axial connector, open cable end, shielded		
KD S-M12-8A-P1-020	Cable length 2m	50135127
KD S-M12-8A-P1-050	Cable length 5m	50135128
KD S-M12-8A-P1-100	Cable length 10m	50135129
KD S-M12-8A-P1-150	Cable length 15m	50135130
KD S-M12-8A-P1-250	Cable length 25m	50135131
KD S-M12-8A-P1-500	Cable length 50m	50135132

Table 9.6: PWR cables for the LSIS 4xx*i*

9.5 Accessory ready-made cables for bus connection

9.5.1 Contact assignment BUS OUT connection cable

BUS OUT (8-pin. connector, A-coded)			
 <p>M12 plug (A-coded)</p>	Pin	Name	Core color
	1	IO5	White
	2	IO6	Brown
	3	GND	Green
	4	IO7	Yellow
	5	IO8	Gray
	6	Rx	Pink
	7	Tx	Blue
	8	FE	Red
	Thread	FE	Bright

Table 9.7: Pin assignments KS S-M12-8A-P1-...

9.5.2 Order codes BUS OUT connection cables

Type designation	Description	Part no.
M12 plug for BUS OUT, axial connector, open cable end, shielded		
KS S-M12-8A-P1-020	Cable length 2m	50135138
KS S-M12-8A-P1-050	Cable length 5m	50135139
KS S-M12-8A-P1-100	Cable length 10m	50135140
KS S-M12-8A-P1-150	Cable length 15m	50135141
KS S-M12-8A-P1-300	Cable length 30m	50135142

Table 9.8: BUS OUT cables for the LSIS 4xx*i*

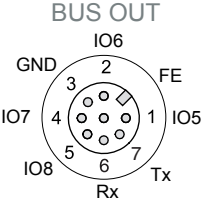

Notice!

Operation of the RS 232 host interface is only permissible with shielded cables with maximum cable length of 10m.

9.6 Accessories for the host/service interface

9.6.1 Ready-made cables with M12 plug/open cable end

M12 Ethernet connection cable (4-pin plug, D-coded, open cable end)				
<p>Service</p> <p>RD+</p> <p>2</p> <p>TD- 3 1 TD+</p> <p>4</p> <p>SH RD-</p> <p>M12 plug (D-coded)</p>	Name	Pin (M12)	Core color	
	TD+	1	Yellow	
	RD+	2	White	
	TD-	3	Orange	
	RD-	4	Blue	
FE	SH (thread)	-		

Type designation	Description	Part no.
M12 plug for SERVICE, axial connector, open cable end		
KS ET-M12-4A-P7-020	Cable length 2m	50135073
KS ET-M12-4A-P7-050	Cable length 5m	50135074
KS ET-M12-4A-P7-100	Cable length 10m	50135075
KS ET-M12-4A-P7-150	Cable length 15m	50135076
KS ET-M12-4A-P7-300	Cable length 30m	50135077

Table 9.9: Ethernet connection cables featuring M12 plug/open cable end

9.6.2 Ready-made cables with M12 plug/RJ-45 plug

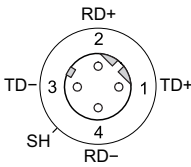
M12 Ethernet connection cable (4-pin plug, D-coded, M12 to RJ-45)					
Service  M12 plug (D-coded)	Name	Pin (M12)	Core color	Pin (RJ-45)	
		TD+	1	Yellow	1
		RD+	2	White	3
		TD-	3	Orange	2
		RD-	4	Blue	6
		FE	SH (thread)	-	

Type designation	Description	Part no.
M12 plug for SERVICE to RJ-45 plug		
KSS ET-M12-4A-RJ45-A-P7-020	Cable length 2m	50109880
KSS ET-M12-4A-RJ45-A-P7-050	Cable length 5m	50109881
KSS ET-M12-4A-RJ45-A-P7-100	Cable length 10m	50109882
KSS ET-M12-4A-RJ45-A-P7-150	Cable length 30m	50109886
KSS ET-M12-4A-RJ45-A-P7-300	Cable length 30m	50109886

Table 9.10: Ethernet connection cables M12 connector/RJ-45

9.6.3 Ready-made cables with M12 plug/M12 plug

M12 Ethernet connection cable (4-pin connector, D-coded, on both sides)					
<p>Service</p> <p>RD+</p> <p>2</p> <p>TD- 3 1 TD+</p> <p>SH</p> <p>RD-</p> <p>4</p> <p>M12 plug (D-coded)</p>	Name	Pin (M12)	Core color	Pin (M12)	
		TD+	1	Yellow	1
		RD+	2	White	2
		TD-	3	Orange	3
		RD-	4	Blue	4
		FE	SH (thread)	-	SH (thread)

Type designation	Description	Part no.
M12 connector + M12 connector for SERVICE		
KSS ET-M12-4A-M12-4A-P7-020	Cable length 2m	50106899
KSS ET-M12-4A-M12-4A-P7-050	Cable length 5m	50106900
KSS ET-M12-4A-M12-4A-P7-100	Cable length 10m	50106901
KSS ET-M12-4A-M12-4A-P7-150	Cable length 30m	50106905

Table 9.11: Ethernet connection cables featuring M12 plug/M12 plug

9.6.4 Connector

Type designation	Description	Part no.
D-ET1	RJ45 connector for user-configuration	50108991
KDS ET M12 / RJ 45 W - 4P	Converter from M12 D-coded to RJ 45 socket	50109832

Table 9.12: Connectors for the LSIS 4xx*i*

10 Maintenance

10.1 General maintenance information

Usually, the LSIS 4xx*i* smart camera does not require any maintenance by the operator.

Cleaning

In the event of dust build-up, clean the LSIS 4xx*i* with a soft cloth; use a suitable cleaning agent if necessary.



Notice!

Do not use aggressive cleaning agents such as thinner or acetone for cleaning the device. Use of improper cleaning agents can damage the housing window and display.

Notice for model with plastic screen:

The surfaces are preferably to be cleaned with standard household dishwashing soap mixed in water, wiped with a soft cloth or sponge, and carefully dabbed dry (never rub intensely!). For a thorough cleaning, solvent-free, antistatic plastic cleaners approved for use with plastics are recommended. Never use abrasive cleaners or organic solvents such as alcohol or acetone, as these could scratch the surfaces or cause cracks to form.

10.2 Repairs, servicing

Repairs to the device must only be carried out by the manufacturer.

↳ *Contact your Leuze distributor or service organization should repairs be required. The addresses can be found on the inside of the cover and on the back.*



Notice!

When sending devices to Leuze electronic for repair, please provide an accurate description of the error.

10.3 Disassembling, packing, disposing

Repacking

For later reuse, the device is to be packed so that it is protected.



Notice!

Electrical scrap is a special waste product! Observe the locally applicable regulations regarding disposal of the product.

11 Specifications

11.1 Specifications of standard devices with integrated lens

Type	Smart camera LSIS 4x2i M4x-W/I/M1(-01)	
Electrical data		
Operating voltage ¹⁾	18 ... 30VDC (PELV, Class 2 / SELV)	
Power consumption	Max. 10W	
Process interface	RS 232, Ethernet 10/100Mbit/s	
Service interface	Ethernet 10/100Mbit/s	
Switching input / switching output	8 switching inputs/outputs, freely programmable functions - Switching input: 18 ... 30VDC depending on supply voltage - Switching output: 18 ... 30VDC, depending on supply voltage, max. = 60mA (depending on output) / 100mA (total current), short-circuit proof Switching inputs/outputs protected against polarity reversal!	
Real-time clock	Time/date (with battery backup; time/date values are retained even if power is lost!)	
Optical data		
Image sensor	Global shutter CMOS	
Number of pixels	752x480	
Electronic shutter speeds	54µs ... 20ms	
Integrated LED illumination	white / RGBW / infrared	
Focal length	8mm (LSIS 4x2i M43...)	16mm (LSIS 4x2i M45...)
Object distance	50mm ... ∞ (LSIS 4x2i M43...)	75mm ... ∞ (LSIS 4x2i M45...)
Operating and display elements		
Display	Monochromatic graphical display, 128 x 64 pixel, with background lighting	
Keyboard	4 buttons	
LEDs	2 LEDs for power (PWR) and bus state (BUS), red/orange/green	
Mechanical data		
Protection class	IP 65, IP 67 (each with screwed-on M12 connectors or mounted caps)	
VDE safety class	III (EN 61140)	
Weight	500g	
Dimensions (H x W x D)	113 x 75 x 55mm	
Lens cover	Glass (LSIS 4x2i...-...1)	Plastic (LSIS 4x2i...-...1-01)
Housing	Diecast aluminum	
Environmental data		
Operating temperature range	0°C ... +45°C	
Storage temperature range	-20°C ... +70°C	
Air humidity	Max. 90% rel. humidity, non-condensing	
LED illumination white/RGBW	Risk group 1 (EN 62471:2008)	
LED illumination infrared	Risk group 0 (EN 62471:2008)	
Vibration	IEC 60068-2-6, test FC	
Shock	IEC 60068-2-27, test Ea	
Continuous shock	IEC 60068-2-29, test Eb	
Electromagnetic compatibility	EN 61000-6-2, EN 61000-6-4	

Table 11.1: Specifications of the LSIS 4x2i M4x-...1(-01) smart camera

1) Protective Extra Low Voltage (PELV) - protective extra-low voltage with reliable disconnection / SELV

11.2 Specifications of devices for C-mount interchangeable lenses

Type	Smart camera LSIS 4x2i M49-X9
Electrical data	
Operating voltage ¹⁾	18 ... 30VDC (PELV, Class 2 / SELV)
Power consumption	Max. 8W
Process interface	RS 232, Ethernet 10/100Mbit/s
Service interface	Ethernet 10/100Mbit/s
Switching input / switching output	8 switching inputs/outputs, freely programmable functions - Switching input: 18 ... 30VDC depending on supply voltage - Switching output: 18 ... 30VDC, depending on supply voltage, I max. = 60mA (depending on output) / 100mA (total current), short-circuit proof Switching inputs/outputs protected against polarity reversal!
Real-time clock	Time/date (with battery backup; time/date values are retained even if power is lost!)
Optical data	
Image sensor	Global shutter CMOS
Number of pixels	752x480
Electronic shutter speeds	54µs ... 20ms
Lens	C-mount
Focal lengths	6 / 12 / 16 / 25 / 35 / 50 / 75mm
Operating and display elements	
Display	Monochromatic graphical display, 128 x 64 pixel, with background lighting
Keyboard	4 buttons
LEDs	2 LEDs for power (PWR) and bus state (BUS), red/orange/green
Mechanical data	
Protection class	IP 65, IP 67 (each with screwed-on M12 connectors or mounted caps as well as mounted lens cover)
VDE safety class	III (EN 61140)
Weight	650g
Dimensions (H x W x D)	113 x 76.5 x 109mm
Housing	Diecast aluminum
Environmental data	
Operating temperature range	0°C ... +45°C
Storage temperature range	-20°C ... +70°C
Air humidity	Max. 90% rel. humidity, non-condensing
Vibration	IEC 60068-2-6, test FC
Shock	IEC 60068-2-27, test Ea
Continuous shock	IEC 60068-2-29, test Eb
Electromagnetic compatibility	EN 61000-6-2, EN 61000-6-4

Table 11.2: Specifications of smart camera LSIS 4x2i M49-X9

1) Protective Extra Low Voltage (PELV) - protective extra-low voltage with reliable disconnection / SELV

11.3 Dimensioned drawings

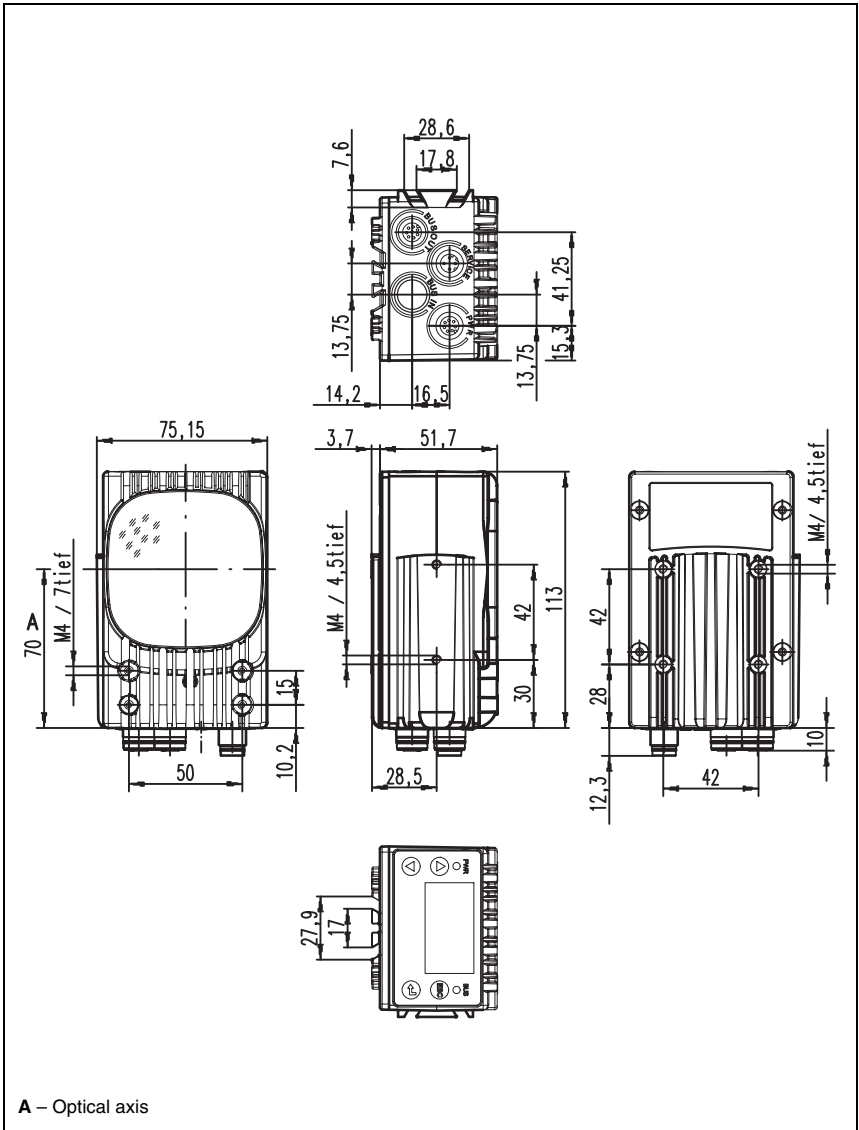

Figure 11.1: Dimensioned drawing of the LSIS 4xxi smart camera - standard devices

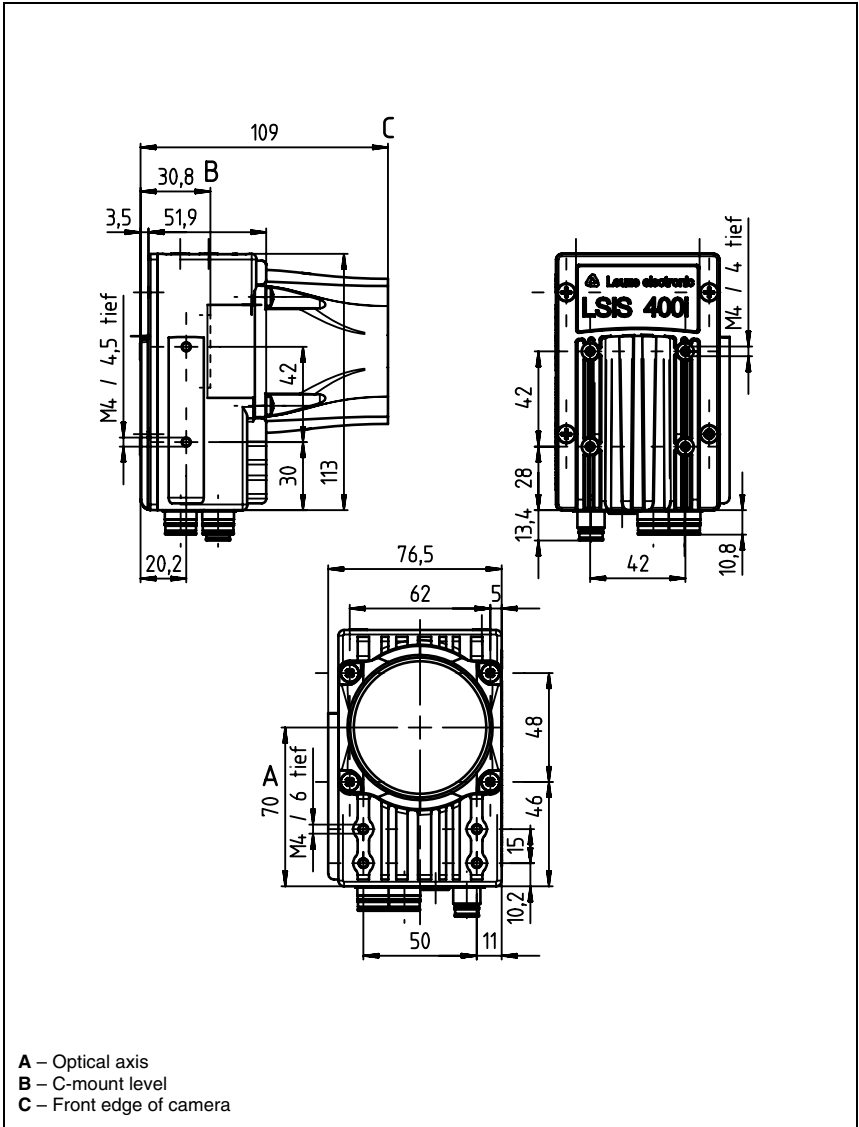

Figure 11.2: Dimensioned drawing of the LSIS 4xx*i* smart camera - devices for C-mount lenses